



COMPUTER GENERATIONS

There's never been anything like the computer in the history of civilization. Historians will eventually have a field day. Computers have changed more in five years than the automobile since its invention. In the twenty-five years of computing, many performance and cost indices have improved by factors of 100,000. Every two years nearly twice as much computing power is available for the same money; or conversely, every two years computers halve in price.

Although computing goes back to the Chinese Abacus—or the Japanese version, the Soroban—the roots of modern computers are found in punch card equipment, particularly its ancestor, the Jacquard loom, which may have operated in the DEC mill at one point. Calculators were built by mathematicians Pascal and Leibetz, but modern mathematicians have given up computer design—leaving computers to the engineers. Though calculators are historically and technologically interesting, they're really dull in comparison to the modern stored-program computer, which gets its power by variable programs, with the ability to calculate rapidly, hold lots of information and even learn.

We mark computer generations by the logic technology they're built from. We're currently in the fourth generation, called large-scale integrated circuit technology. The first generation began in 1945 with vacuum tubes and ran until about 1958. The single

transistor package started then and lasted until about 1966. At that time, multiple transistors were put in a package to form a single functional array. In 1972 the fourth generation began, at which time a whole processor was put on a single substrate.

The first modern stored-program computer was probably the Manchester University prototype and we have a valve (tube, to us) from it—so Prof. Sumner, who sent it to us, said (it's clearly not from his TV set). The first useful stored-program computer was EDSAC of Cambridge University, built by Maurice Wilkes' group; Wilkes also invented the micro-programming concept. Wilkes was at the University of Pennsylvania where Eckhart, Mauchly and von Neumann worked to conceive the stored-program computer, which we now also call the von Neumann computer.

We now, overzealously I suspect, attribute Charles Babbage as being the father of modern computing. He had the notion of the stored-program calculator in the mid-1800's, but never got one of his computers to run, because each time he got a better idea for a new computer before the old one worked. In fact, he established other traditions carried into modern computing, including working with unbuildable technology. This caused him to solve a number of peripheral problems, such as making gears better than they had ever been made before. He also was about the first person to receive a government grant—for calculating nautical tables. These research projects were late and had cost overruns.

If Charles was the father of computing, then Lady Loveless, his benefactress, co-worker, and friend, was at least a midwife. But more importantly, she was probably the first programmer. Another tradition established there was that she complained that the machine specification was always changing.

If we look at the ancestry of the minicomputer, it is clearly MIT's Whirlwind. These machines and people had a profound effect on DEC. Ken Olsen, Dick Best, George Gerelds and several others of DEC are Whirlwind alumni, and I even wrote a program for it once. The PDP-1 was very much like Lincoln Lab's TX-0 (one of the earliest transistorized machines), and TX-0 like Whirlwind. Beginning with Whirlwind, we can see four generations of minicomputers. It was operational in 1950 and was packaged in a two-story building. The second, our own PDP-1,

FOUR GENERATIONS OF MINICOMPUTERS

	MIT WHIRLWIND	DEC PDP-1	DEC PDP-8/I	DEC LSI-11
GENERATION	first (1950)	second (1960)	third (1968)	fourth (1975)
PRICE	?	\$120,000	\$10,000	\$650
PACKAGE	Building	4 Cabinets	Box	Board
SIZE	50'x50'x20'	8'x2.5'x6'	2'x2'x2'	8.5'x10'x.5"
POWER (Watts)	150,000	2,500	250	50
SPEED (Mem- ory accesses/ second)	80,000	200,000	600,000	833,000

(PART OF) EARLY COMPUTER HISTORY INFLUENCING MINICOMPUTERS

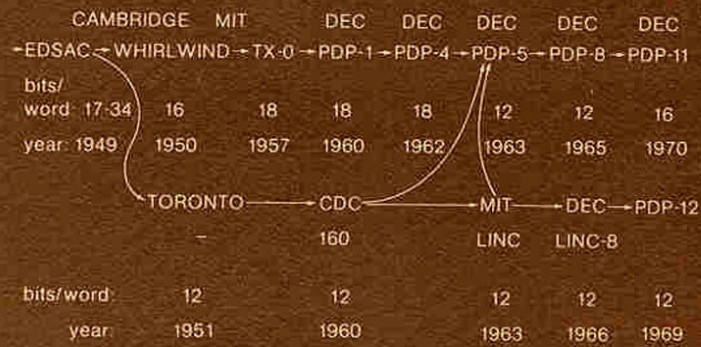

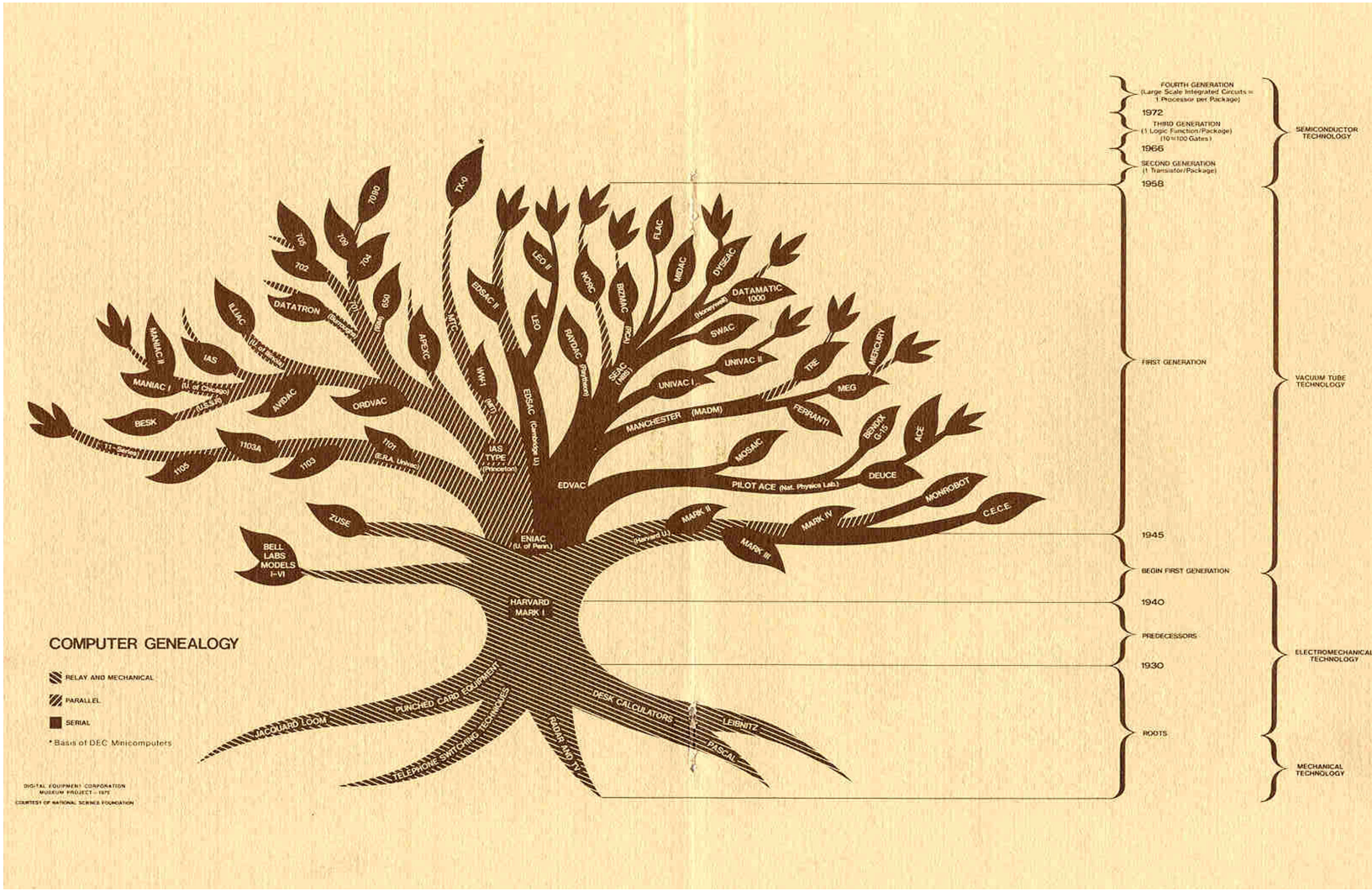



MIT Whirlwind (very early first generation)



PDP-1 (early second generation)



PDP8 (late second generation)



PDP-8/L (8/i derivative; mid third generation)

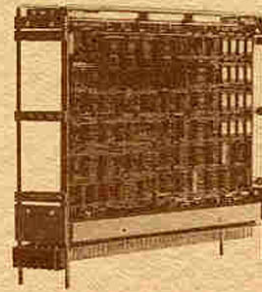

LSI-11 (early fourth generation)

was packaged in only four six-foot cabinets. The third generation PDP-8/I occupied about eight cubic feet and now, in the fourth generation, we have the single-board LSI-11, which is $\frac{1}{2}$ " x 8" x 10", but it also has over ten-times the calculating power of Whirlwind. Most important, the price has come down by a factor of nearly 200 these last 15 years, which amounts to about 41% compounded per year; that is, every two years the price has halved. This permits new uses of the computer that are in the scale of the application.

The size too has changed, going from a building to a single board. The input power has decreased by a factor of 3,000 from Whirlwind. Whirlwind required 150,000 watts and when it ran, the lights in Cambridge dimmed. A Whirlwind flip flop, which stores a single binary-digit (bit) occupied a volume of about eight cubic feet. In the LSI-11, the same function takes an area of silicon that is only about one hundredth by one hundredth of an inch. Whirlwind had the five conventional computer elements: input, output, control, arithmetic, and storage. Control was an area of the room that one walked through. The storage tube invented at Manchester University was initially used. The arithmetic element gives us the notion of word length. Whirlwind word length was thirty-two feet and a bit slice took up about two feet. We could walk along the bits and the various registers were piled on top of one another. The console was also a place one walked around to look at lights and flip switches. Here we've not made similar strides in console design because there haven't been advances in miniaturizing people.

Whirlwind made important contributions to computing including the cathode ray tubes and light pen input which most computers still don't have, but eventually will if they communicate with people. But Whirlwind is probably most remembered for its innovative magnetic core memory, which is still in use over three generations.

The University of Illinois was particularly prolific. They used the storage tube (invented at Manchester University) in ILLIAC I, a direct descendent from the Princeton Institute for Advanced Studies' machine. A number of the ILLIACs were made and distributed around the world. Illinois built ILLIAC II, and ILLIAC III, second generation machines, but their most recent machine, ILLIAC IV, built with Burroughs, is still to be fully operational.

Industry began building computers in the early 1950's. English Electric built a machine called the Deuce which came out of the English National Physics Laboratory. Contrast this with modules from the IBM 650, and the 704. Probably one of the most easily produced second-generation packaging technologies was that of IBM for the 7090. Burroughs had an interesting package called Cordwood.

DEC's own modules came at the beginning of the second generation. The first modules allowed experimenters to easily build digital systems together. The systems modules allowed permanent digital systems to be made, but more important, they provided the basis for building digital computers. These were the modules from which the PDP-1, -4, -5, and -6 were made.

The flip-chip modules were built for the PDP-7 and -8 so that modules could be made more easily and the back panels could be wrapped automatically. Subsequently, this style of module packaging has been used to include more components and has lasted us through the third generation with the integrated circuits and on into the fourth generation, where it is used for the LSI-11. And there's really no reason to change unless the fifth generation is a big surprise, but that's a few years away, if past generations are any indication.



GORDON BELL
Vice President, Engineering

DIGITAL EQUIPMENT CORPORATION
MUSEUM PROJECT-1975

digital

digital equipment corporation

maynard, massachusetts 01754

Digital Computer Museum

First Annual Report

Although the idea for the Digital Computer Museum was a vision of Ken Olsen and then Gordon Bell for a number of years, funding by DEC did not bring results until last year. The first Computer Pioneer lecture by Maurice Wilkes on September 24, 1979 marked the completion of phase zero. The response from the September event was so positive that it triggered staffing the Museum and permanent establishment. At the end of the first year, we have accomplished the following:

- * A format for building exhibits was established;
- * Literature and documentation was developed; and
- * A lecture and event series was started.

This document has three parts. The first section relates the historical reasons for the Digital Computer Museum and outlines the general scope of the program. The second section expands on the current status and plans for fiscal 1981. The third section outlines ideas for the future growth and development of the Museum.

I. WHY THE "DIGITAL COMPUTER MUSEUM"

Several unrelated events and decisions all worked in the direction of Digital Equipment Corporation developing the Digital Computer Museum. Ken Olsen took it upon himself to preserve and store Whirlwind, TX-0 and early DEC equipment in a warehouse facility. Gordon began a collection of early calculators and logic devices and wanted to continue and expand his interest in the taxonomy of computers. A consultant/curator was hired and came up with a report of other museums. Her activity was shortlived because the approach was to do a computer museum for the public -- looking costly and not very sophisticated and was further doomed by an industry depression. Both Ken and Gordon went to other computer exhibits and were extraordinarily disappointed that the Smithsonian was not making an effort to appropriately classify and organize its material; fascinated by the IBM wall (now in a warehouse) but considered that its emphasis on the interaction of social events and computing was not the story to be told; impressed with the solid display at the Museum of Science in London; totally dismayed that the computer exhibit at Boston's Science Museum was only a superficial display ad for Honeywell; and delighted that the Boston Children's Museum could teach computing (hence DEC supported this effort.)

These events led to both Ken and Gordon to conclude that a Digital Computer Museum was needed. Ken's goal, to create a place to preserve machines so that computer scientists, engineers, and programmers can see the antiques that they had worked on as little as ten years ago, and Gordon's goal, to create an understandable taxonomy of all computers and related

computing devices, are complementary.

The role of the Museum is to make sure that significant artifacts are kept. Having the original or a copy (eg. Guatelli made replica of Babbage's Difference Engine) that appear in various museums), is necessary in order to distinguish a museum from a special library. As a hardware oriented company, the preservation of artifacts and documentation of significant software is appropriate. Unfortunately, many parts of early machines have already disappeared and a few good photographs are available. Hence, the Museum will collect what is available and try to insure that good portraits are taken of classic machines. (One of the dreams for the Museum is to have life sized holograms of the machines so that one could in effect walk through them. Failing this, then projecting life sized photographs provides an alternative.)

The priorities for the Digital Computer Museum are to exhibit real time, scientific and interactive computing, with a limit of 50% of the exhibits directly pertaining to Digital Equipment Corporation. Eventually all items will be identified within a taxonomic structure of pre-computer and computer generations in order that the viewer can understand the evolution of computers. The first step has been taken in this direction with the production of a PDP-tree poster.

These goals have been discussed informally with some eminent computer historians and explained to others in seeking their cooperation. The first newsletter, attached, shows a listing of people and institutions that have contributed thus far. We have found enthusiasm for our efforts and have generally been plummeted forward by positive feedback, obtaining many hours of free services from both inside and outside DEC. Thus, like most Museums, our budget, is magnified by the gifts of time and artifacts.

II. PRESENT STATUS

The Digital Computer Museum, was sanctioned by the Operations Committee of the company a year ago. January 1, 1980 the Museum staff was in place. Gordon Bell, Keeper provides direction for the program, and through Mary Jane Forbes, Administrator, the Secretariat for the Operation. Gwen Bell, Assistant Keeper, provides day to day direction on a full-time, volunteer basis. Jamie Parker, Coordinator, is the only salaried member of the Museum Staff. The security and building group at Marlboro provide their services as needed under the direction of Joe Savignano and Dave Yates. As landlord, Joel Schwartz's support and assistance in direction setting has been essential. While we pay for warehousing space, the Museum space itself carries no charge since it is the lobby and balcony of a beautifully designed Vincent Kling building (constructed for RCA). Individuals who have contributed to specific exhibits are acknowledged below. An advisory committee representing various cooperating groups within DEC, eg., Industrial Design, Digital Press, Public Relations, etc., meets occasionally to review progress.

The activities can be categorized into five areas: archives, exhibits, events, products, and public relations. Each are discussed separately, and then related corporate activities reviewed.

Archives.

- * Cataloging and storage. During the summer of 1979, all the artifacts in the warehouse were photographed and cataloged. The system is being kept up to date, with the ability to track artifacts. The database is not yet computerized -- a task that we would like to accomplish in fiscal 1981.
- * Exhibit directory. A directory of all exhibits as of September 24, 1979, is on the VAX system and can be queried by Museum visitors.
- * Video and audio tapes. Video tapes of all lectures in the computer pioneer series will be made. The video tapes of the first lecture by Maurice Wilkes are now available. Gordon also plans to start to make audio tapes of informal discussions with people who worked on the early machines. Other video and audio tapes by computer pioneers will be acquired as they become available.

Exhibits.

- * Whirlwind. This exhibit of the memory, a register and other parts is being supplemented with some photographs, and the publication of a DEC Press book by Redmond and Smith on Whirlwind.
- * TX-0. The TX-0, replicating its appearance at MIT in the 1950s, has been installed by John McKenzie, the technician who maintained the machine at MIT (now retired) and

- Stanley Schultz. A group of TX-0 alumni are getting together to discuss improving the display and perhaps getting the machine to run.
- * **Calculators.** New cases were purchased for the calculators and this exhibit, essentially complete, will continue to be improved. We are looking for the Anita -- the first electric calculator. Gwen is now working on a poster of the generations of pre-computer calculating devices and writing a A/V user activated slide talk to explain their evolution. This should be complete by September 1980. The project may also result in a small picture book.
 - * **Office of the Past.** Mary Jane Forbes has put together an exhibit (in a closet) of the office circa 1910. This will be completed prior to September, 1980.
 - * **Logic Devices.** Three cases are used to exhibit the four generations of logic devices. These are explained in a user activated slide talk given by Gordon Bell. This exhibit will grow as we get more early artifacts from critical early machines.
 - * **Memory.** Three cases show the four generations of primary memory devices. In addition, a large disk and a transparent RKO5 are exhibited. A secondary memory devices exhibit and a user-activated slide-talk are in the planning stage.
 - * **Analog computers.** An analog computer is displayed simply give the visitor an idea of what these were like. This exhibit should be developed.
 - * **PDP Family of Computers.** A poster of the family tree of the PDP computers has been completed and is available. This family tree will be used with all displays of DEC machines to identify their relations with the other machines. Specifically, PDP-1 is running with the original Space War program. Stan Schultz has taken this as his project and is now putting joy sticks on the machine. He also sees to it that the Classic 8 runs with non-interactive demonstration programs. An 11/20 is on the floor along with the original hand-done artwork for one of its modules. The other mainframe machines are represented by consoles, documentation, and photographs. The LINC is the first of DEC's personal laboratory computers on display. The LINC-8, PDP-12, and a working MINC are complemented by a user-activated slide talk introduced by Dick Clayton, The basis for this comes from two films -- one made by National Educational Television and the other by the DEC LDP group. Peggy Sullivan has been coordinating these efforts.
 - * **Computer Art.** An exhibit of four lithographs by Harold Cohen, University of California-San Diego, is displayed on the first floor. We have agreed with the artist, who uses a PDP-11 to create artwork by artificial intelligence, that he will paint a mural for the museum totally covering

one of the balcony walls. We will document the making of the mural for a user-activated exhibit. See events for more information on this project.

- * Computer Music. We have been in contact with Barry Vercoe of MIT and John Chowning of Stanford. Barry Vercoe has agreed to compose a piece of music specifically for the museum space, probably making use of the computing capability of the VAX. John Chowning composed music on the PDP-1 and we are in touch with him to gain access to this. These projects will probably come to fruition in fiscal 82.

Events.

- * Sept. 24, 1979. Luncheon opening by the Operations Committee of Digital Equipment Corporation.
- * Sept. 24, 1979. Computer Pioneers, Lecture 1, Maurice Wilkes and the EDSAC.
- * April 5, 1980. VAX five-year birthday party celebration. All of the people who brought VAX into the world came to a celebration, each bringing a VAX artifact to contribute to the Museum.
- * May 8, 1980. Computer Pioneers, Lecture 2, George Stibitz and the Bell Labs Relay Computer. (A mailing list of 200 people outside of DEC has been developed. About 50 of these people are in the Boston/Amherst area and are being invited to the lecture.) The newsletter format will be used to announce these public lectures.
- * Sept. 22, 1980. Museum dinner for the Board of Directors of the Corporation introducing them to the museum.
- * Sept. 23, 1980. Opening, lecture - demonstration. Mural by Harold Cohen. Jamie Parker is coordinating this event to bring in people from the "art" and "museum" as well as the "computer" world.
- * Employee family open houses to be coordinated with the entire Marlboro facility through Joel Schwartz.
- * Future events: Computer Pioneer Lectures -- Forrester coordinated with publication of DEC Press book on Whirlwind by Redmond and Smith; then Atanasoff, Eckert, and Burks will be asked; Board meeting of the Charles Babbage Institute.

Products.

The Museum is planning on having a small "store" of appropriate products. In addition, we will do a number of things that will be free. (First the free items.)

- * Buttons with the core memory symbol to replace the visitor badge for people coming to the Museum.

- * Newsletter. Number 1 is attached to this document. We distribute internally by EMS, and via hard copy to those without EMS access and to our outside list. The newsletter will keep people up to date on our progress and be issued occasionally as the need is felt.
- * PDP Family Tree poster.
- * Products for sale.
 - Pre-computer Generations poster. (This is now being designed and should also be ready for September.)
 - History books from DEC Press. The Press has an allocation of two books per year on computer history. These will be on sale along with the Bell/Mudge/Mcnamara book on the DEC Computers.
 - Other books, such as Eames, Computer Perspectives, Harvard University Press.
 - Simple Calculating Devices. We are talking to the SEE Corporation about selling their reproductions of the Pascal Adder and Napier's Bones.
- * Products on Display. The Annals of Computing History and Charles Babbage Institute Newsletter will be displayed with appropriate order forms for those

Public Relations and Museum Visitors.

Our strategy has been to slowly open the Museum. DEC-related groups and visiting computer scientists have begun to find the Museum and go through it on their own. There would seem to be an opportunity to cooperate with both DECUS and the educational groups to insure that the facility and the archives are accessible and used.

We have provided special tours for classes from both MIT and Harvard, as well as several local high school groups. Unescorted high-school groups can and have wrecked havoc in the Museum -- the PDP-1 groaned for a week until Stan Schultz could come and fix it. In the present state of exhibits, the viewer needs to have an appreciation for the delicacy of what might look like an indestructible machine.

A guest book is on the desk for visitors to sign.

Relations with other institutions.

Although we can't take on the world, we want to keep abreast of what is happening so that we can allocate our time and efforts appropriately.

- * Support for other exhibits. Corporate Contributions give computers to support museums including a computer for the Boston Symphony Orchestra for it's 100th anniversary next year, a PDP-8 to the Canadian Science Museum in Ottawa, and a PDP-8 and a plane from the first core memory on Whirlwind to the British Science Museum. We forward parts to the Smithsonian when they take them (Whirlwind core memory and display that Mitre put together). Requests for artifacts from our archives may be made directly to the Museum or go through Corporate gifts. We hope to loan artifacts and displays to both DEC sites and other institutions.
- * Ken supports Charles Babbage Institute and we cooperate with them in our complementary interests, although we have requested the Corporation to fund the Digital Computer Museum instead of CBI given the limited supply of money.
- * We did not take on any of the Codasyl archives because it is open ended and feel that others should take on this responsibility; similarly, we did not contribute to archiving the Mauchley papers because we feel that Univac and the Penn. must do this. We would undoubtedly support something which would be otherwise dropped.
- * The Museum staff visited the IBM warehouses April 17th.
- * Gwen is going to the opening of the Computer Exhibit in Ottawa, April 30, and will visit the Children's Museum in Washington the first week of June. She hopes to develop cooperation so that we might "sell" each other's products learn from each other's displays, and look at feasibility of joint, display design and generation.
- * Gwen and Jamie will attend the American Museum Association meeting in Boston in mid June. They plan to invite Museum people from scientific museums to see the Digital Computer Museum and will attend appropriate seminars.

III. FUTURE GROWTH AND DEVELOPMENT

We are trying to build a system to archive, build displays, slide talks, etc. so that the museum will grow and develop. Two new avenues appear to be appropriate -- the Museum will fund people who want to put up appropriate displays and we will formalize a small outside group of advisors who are known as computer pioneers and historians. On the first, we have written to Professor Cohen at Harvard, Professor Randell at Newcastle, and Professor Wulf at CMU suggesting that one of their computer science students might propose to do an exhibit for the Museum. The TX-0 alumni group might also come up with some ideas for displays. On the second, a small outside group of advisors might be able to help the Museum acquire artifacts outside of DEC and in accomplishing our goal of becoming the computer museum for computer professionals.

On our own, funded at the present level, we are confident of an exciting and growing future and are ending this document with a short list of a few of the exhibits focussing on real time, scientific and interactive computing and its predecessors.

Ideas for future displays.

- * Scale dioramas of the development of card tabulating and computing;
- * Other pre-computer artifacts (eg. Network analyzer);
- * I/O Equipment, and communications equipment;
- * Secondary Memory, including recording techniques;
- * Integrated Circuits- getting artifacts from TI and Intel
- * Important computers: Cray's machines, 360/370, Amdahl, Intel, Manchester, BTL, Penn. MIT and others;
- * First Generation computer photo gallery;
- * Multiprocessors, multicomputer and network structures--including CMU's;
- * Computing in laboratories before computers;
- * Miscellaneous application displays (eg. power control, air traffic control, EKG's, trains, process control);
- * A Programming Languages display;
- * On the importance of algorithms;
- * Important systems (eg. UNIX/MULTICS, FORTRAN, COBOL, APL);
and
- * Robots (including automatons).

Attachment: First Newsletter
Brochure

GB1.S13.27

Gordon Bell, Keeper

Gwen Bell, Assistant Keeper

DIGITAL COMPUTER MUSEUM REPORT

1/1982

1600

1810

1900

1950

1960

1970

Memories including books and magnetics

Controls including water clocks and governors



Links & Switches including telephony and telegraphy

Transducers including typewriters and printers

Calculators including analog and digital calculators

Digital Computers including processors

Robots

Craft

Mechanical

Electro-mechanical

Electronic

Transistor

IC

Digital Computer Museum

Collections



Charles Bachman
 C. Gordon Bell
 Gwen Bell
 Harvey C. Cragon
 Robert Everett
 C. Lester Hogan
 Theodore G. Johnson
 Andrew C. Knowles, III
 John Lacey
 Pat McGovern
 George Michael
 Robert N. Noyce
 Kenneth H. Olsen
 Brian Randell
 Edward A. Schwartz
 Michael Spock
 Erwin O. Tomash
 Senator Paul E. Tsongas

The Digital Computer Museum is an independent, non-profit, charitable foundation. It is the world's only institution dedicated to the industry-wide preservation of information processing devices and documentation. It interprets computer history through exhibits, publications, videotapes, lectures, educational programs, excursions, and special events.

Hours and Services

The Digital Computer Museum is open to the public Sunday through Friday, 1:00 pm to 6:00 pm. There is no charge for admission. The Digital Computer Museum Lecture Series Lectures focus on benchmarks in computing history and are held six times a year. All lectures are videotaped and archived for scholarly use. Gallery talks by computer historians, staff members and docents are offered every Wednesday at 4:00 and Sunday at 3:00. Guided group tours are available by appointment only. Books, posters, postcards, and other items related to the history of computing are available for sale at the Museum Store. The Museum's lecture hall and reception facilities are available for rent on a pre-arranged basis. For information call 617-467-4443.

Staff

Gwen Bell
Director
 Jamie Parker
Exhibit Coordinator
 Christine Rudomin
Program Coordinator
 Jay McLeman
Computer Technician
 John McKenzie
TX-0 Technician
 Beth Parkhurst
Research Assistant
 Sue Hunt
Administrative Assistant

The museum's birth and parentage were responses to different needs that sprang from several sources. When Ken Olsen and Bob Everett saved Whirlwind from the scrap heap in 1973 and arranged to exhibit it at the Smithsonian, they also envisioned a place where all the treasures related to the evolution of computing could be preserved. Then Ken bought the TX-0, the first full-scale transistorized computer, when it came up for auction. Soon word went around that he was maintaining a warehouse for old computers and the industry responded with donations of a LINC, a PDP-8, and other classic machines that otherwise would have been junked.

At the same time, Gordon Bell was also thinking about a computer museum, an idea which emerged while writing *Computer Structures* with Allen Newell between 1967 and 1970. They studied all the computers to that date and developed PMS, a notation capable of characterizing all information processing systems. While writing about the machines, Gordon started visiting them and bringing back artifacts. Soon his office and home were filled with modules of the Atlas, the IBM 650, the ILLIAC II, memory devices that predated the core, and calculators that preceded computers.

Still, Gordon was complacent with the thought of a potential museum until he travelled to Japan where Fujitsu proudly turned on its first relay computer for him to admire. He was convinced. If the Japanese could pull this off, then he, Ken Olsen, and Bob Everett should be able to display the TX-0 and other early machines. But there was no budget or space for the Museum.

This time, RCA saved the day. The Marlboro "tower building" constructed by RCA in 1970 and later purchased by Digital had a grand lobby and open balcony waiting to be used for exhibits. Gordon thought that it might somehow provide a setting for the TX-0, and he formed a volunteer committee to evaluate the space.

I was one of the volunteers. Having used the TX-0 in graduate school, I knew how the room felt at MIT, and the balcony area seemed reminiscent of that. The building's residents agreed to accommodate the museum collections. Two college students were hired for the summer to catalogue the artifacts in Gordon's office, photograph the computers that Ken had accumulated in the warehouse, and assemble exhibits with the aid of Digital's industrial designers. Gordon applied the PMS taxonomy from *Computer Structures* and wrote the text panels for the exhibits.

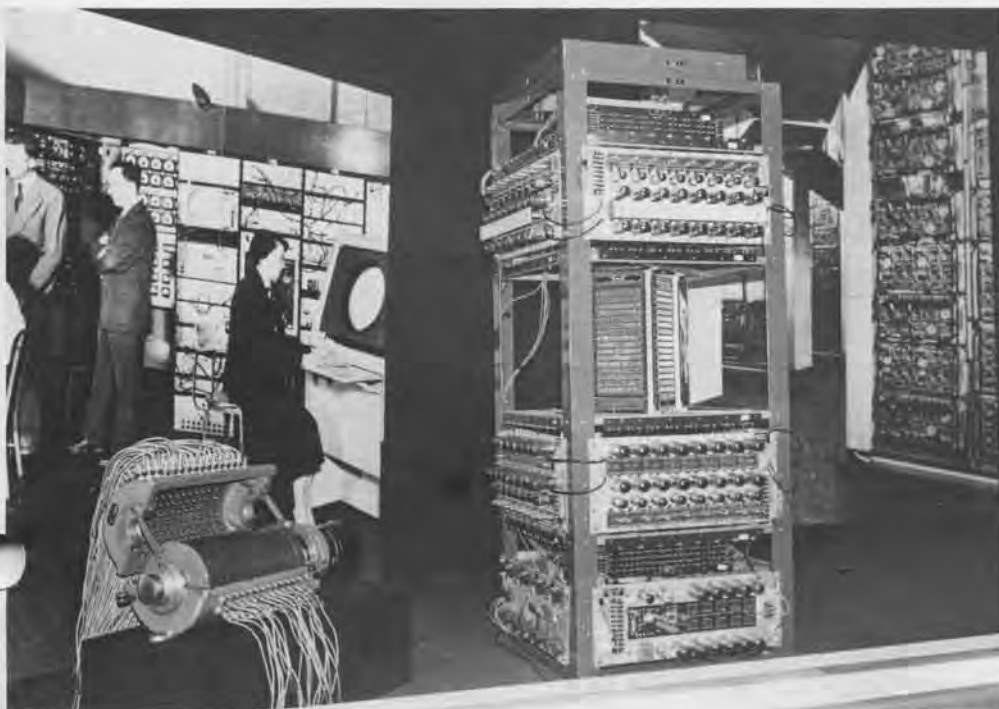

On September 23rd, 1979, the Digital Computer Museum opened with a lecture on the EDSAC by Maurice Wilkes. And while Ken and Gordon were very proud that the collections had been assembled, no one was available to attend to the business of maintaining the collection, providing tours, or accepting new donations.

In November 1979, Jamie Parker, a recent Vassar College graduate, was hired as the first employee and the Museum became operable on a daily basis. A year later, the Operations Committee of Digital Equipment Corporation decided to develop a truly representative, industry-wide museum for the preservation of computing history and I was hired as the Director.

Digital Equipment Corporation not only provided start up funding, but encouraged employees in the legal, financial, marketing, public relations, administration, sales and service, and engineering departments to donate their time and talents to this cause. The birth of the Museum is coincident with the twenty-fifth anniversary of the founding of Digital Equipment Corporation; and the Museum is the corporation's twenty-fifth birthday present to the public as a way to insure the preservation of the history of computing for future generations.

Establishing the Full-Fledged Public Museum

My first task was to transform a private collection into a public foundation with full charitable status. A distinguished board of directors, representative of the diverse nature of the information processing industry, was assembled. The Members Association encourages participation by anyone interested in the Museum's focus and activities. These two groups provide the interface between the Museum's public and its staff, keeping the direction on course and responsive.

The staff has grown and taken on specialized roles. Jamie Parker, exhibit coordinator, planned the Pioneer Computer Timeline, and finds a place for each significant new acquisition. Chris Rudomin, program coordinator, organizes the lectures and seminars, the store, and educational programs. Sue Hunt is the Museum's coordinator of everything else and with a bank of word processors provides our day-to-day support. Jay McLeman, a full time staff member, cares for the operating machines. John McKenzie, who is TX-0's lifetime technician, is working on the long and arduous re-entry of the TX-0 into the world of operating computers.

A phalanx of students tackle special projects. Since the fall of 1980, Professor Mary Hardell of Worcester Polytechnic Institute has arranged that computer science students can complete their Interactive Qualifying Project at the Museum. These range from research papers on benchmark programs, such as Space War on the PDP-1, to preparing explanations of exhibits, such as the Atanasoff-Berry Computer breadboard. Beth Parkhurst has a part time position while she is a fulltime PhD candidate in the History of Technology at Brown University. She wrote the text for the Pioneer Computer Timeline and is editing a videotape of the ENIAC made from old newsreel films. Five additional college students will be hired for this summer.

As Director, I have focussed on acquiring artifacts, conceptualizing projects, and acting as the Museum's spokesperson. On a trip to England in February we acquired the micro-processor from the EDSAC II from the Science Museum, the console of the IBM 360/195 from Rutherford Labs, a full-scale Williams tube, and a logic door from the Ferranti Mark I* from the University of Manchester. Documentation services and a photo and film archive will be realized in the next year. In October I chaired a session on Computers in Museums at the Association of Science and Technology Centers meeting at the Exploratorium in San Francisco and have consulted with other Museums including the Capitol Children's Museum, Washington; The Science Museum, London; the Ampex Museum, Redwood City; and The National Museum of Science and Technology, Ottawa.



Guidelines for the Future

Our main thrust is to develop the collection and continue the tradition of saving classic machines from the junk pile. We rescued the last operational STRETCH, saved the major components of the very first CDC 6600, and collected the Philco-Ford 212 before it was to be scrapped. The first priority is saving history, the second is to display it, and then the third is to interpret its historic role. The exhibits, therefore, are dynamic and evolutionary.

Five tested policies have crystallized.

1. The major purpose of the Museum is the historical preservation of the evolution of computers. To that end, the PMS notation forms the basis of the taxonomy determining the extent of the kingdom of computing and providing guidelines for exhibits. Jan Adkins of the National Geographic Society captured the essence of the venture when he said to me, "You must feel like the Director of the Museum of Natural History when he started to collect bones."
2. The lecture series that started with talks on pioneer computers by people who had personally worked with them will be expanded to a series of seminars in a similar vein. Andy Knowles, a member of the Museum's Board, is fond of reminding me that, "There is no history, only biography." Thus, we are giving the podium to people who can give first-hand biographies of machines, programs, and languages they have known.
3. The focal point of the Museum is the machines themselves. Frank Oppenheimer, the Director and Founder of San Francisco's Exploratorium counsels, "Well-engineered machines speak eloquently of their own elegance. Museum designers can't equal them." Revealing the intrinsic beauty and functionality of the exhibited machines is our challenge and goal.
4. The main audience for the historic and archival collections are computer scientists, programmers, history buffs, and those with a curiosity about computer evolution. The Museum will provide a sense of the feel of machines and programs from various eras. Spacewar, the first computer game, feels totally different running on the 1961 PDP-1 than it feels on a small arcade machine. This is hardly apparent to a youngster whose only Spacewar experience is in an arcade, but it is the feel of the PDP-1 that almost brings tears to the eyes of those who were computing during its era. As board member George Michael says, "Hey, this is a Museum for us big kids."
5. The Museum encourages broad-based involvement by maintaining a good working relationship between the enthusiastic volunteers, donors of artifacts, patrons, students, scholars and a staff that can keep stirring the soup. Harold Cohen, creator of our computer-designed murals, observed that the Museum doesn't . . . "have to convince the computer community to support the museum because its artists are worth supporting; they are the artists. It is completely different from any other museum that I know."

Because the Digital Computer Museum is unique, its rules need to be invented. This inaugural report provides a baseline from which the Museum can flourish in a multitude of directions. I hope that you will join me in this process.

Gwen Bell
Director



The Museum's charter is to accept and preserve artifacts and documentation of the history of information processing. Our "starter" collection is listed below. New acquisitions will be recorded each June in the *Report*. The Museum will also publish occasional catalogs that will cover one area in depth.



Project Stretch started in 1954 and introduced a number of new ideas evidenced by a set of new terminology such as "byte," "I/O interface," and the word "architecture" as applied to computers.

Bendix G-15 (X48.82)
Gift of the Science Museum of Minnesota

Control Data Corporation,
 CDC 160A
On loan from Control Data Corporation

Control Data Corporation,
 CDC 6600 (X38.81)
Gift of Lawrence Livermore National Laboratory

Digital Equipment Corporation,
 MINC (D155.80)
Gift of Digital Equipment Corporation

Digital Equipment Corporation,
 PDP-1 (XD116.79)
Gift of Inforonics Corporation

Digital Equipment Corporation,
 PDP-7 (XD143.80)
Gift of Worcester Polytechnic Institute

Digital Equipment Corporation,
 PDP-8 (D117.80)
Gift of Digital Equipment Corporation

Digital Equipment Corporation,
 PDP-11/23 Microcomputer (D33.80)
Gift of Digital Equipment Corporation

Digital Equipment Corporation,
 PDP-11/45 (D9.81)
Gift of Digital Equipment Corporation

Digital Equipment Corporation,
 PDP-12 (D156.81)
Gift of Digital Equipment Corporation

International Business Machines Corporation, IBM 7030, "Stretch" (XD250.81)
Gift of Computer Services, Brigham Young University

Librascope General Precision,
 LGP-30 (X14.81)
Gift of MIT Museum and Historical Collections

Lincoln Laboratories, LINC (D118.79)

Lincoln Laboratories, TX-O (D154.75)
Gift of Digital Equipment Corporation

MIT, Altair 8800 (X58.82)

Massachusetts Institute of Technology, Whirlwind (D29-32.73)
Gift of Digital Equipment Corporation

NASA Apollo Guidance Computer Prototype (X37.81)

Gift of Charles Stark Draper Laboratory. Designed and built at Charles Stark Draper Laboratory, manufactured by Raytheon.

Philco-Ford 212
Gift of Ford Motor Company

Remington Rand, Univac Solid State 80 (X33.81)

Gift of Jodie S. Hobson

Siemens 2002 (X20.81)
On loan from Siemens Corporation

Texas Instruments, Advanced Scientific Computer (XD224.80)
Gift of Texas Instruments

Lawrence Livermore Laboratories donated the CDC 6600 serial number one. Designed by Seymour Cray between 1960 and 1964, the 6600 made order of magnitude improvements in the speed of computing. Three of the four bays of the central processing unit, the double-tubed video monitor, and high-speed printer are on view.

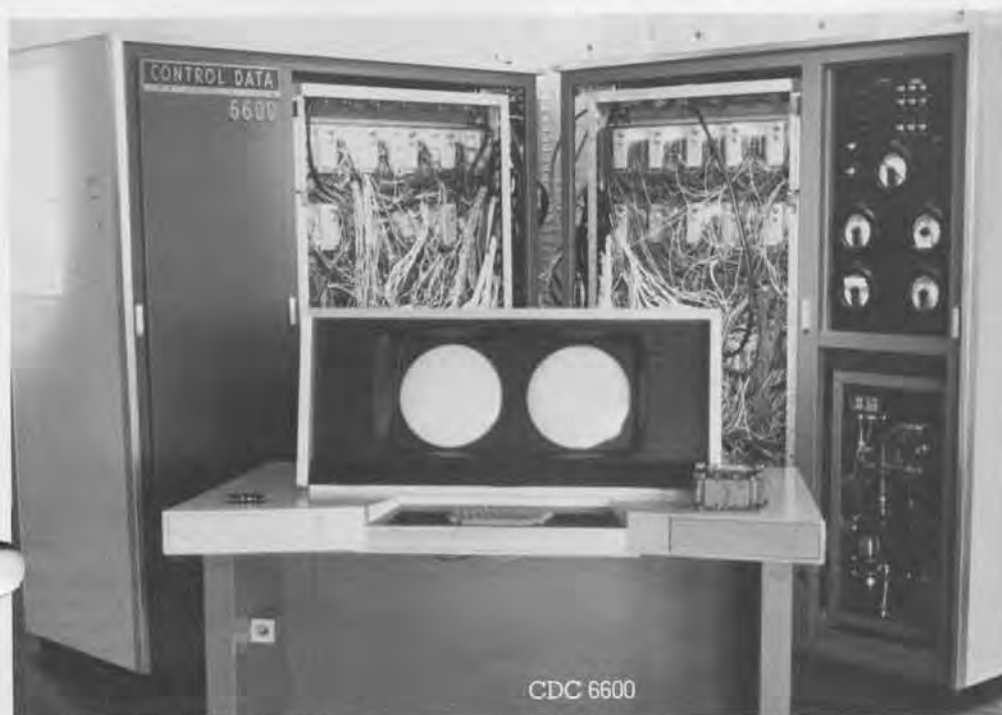

In April 1965, the idea of the minicomputer was realized with the delivery of the first PDP-8. The processor of this Classic Eight was housed in a transparent box revealing the elegance of its logic modules.

Amphenol, Vacuum Tubes (X77.80)
Gift of Gary Papazian

Bell Telephone Laboratories,
 Transistor GA-51984 (X31.81)
Gift of Carver Mead

Bendix G-15 Bit Slice (D202.80)

Berkeley Scientific Corporation,
 Decimal Counting Unit (D205.80)

Clar Stat Amperite, Ballast Resistor
 Tubes (Regulators) (X79.80)
Gifts of Gary Papazian

Computer Controls Corporation,
 Logic Module (D111.80)

Control Data Corporation, STAR
 Logic Module (XD218.80); 6600
 Transfer Board (XD223.80)
*Gifts of Lawrence Livermore
 National Laboratory*

Cray Research Inc., Cray I
 Interface Module (XD226.80)
*Gift of Lawrence Livermore
 National Laboratory*

DCS Power Amplifier (X60.82)
Gift of Bob Glorioso

Digital Equipment Corporation,
 Bit slice triple flip-flop (D201.80);
 Classroom Module (D206.80);
 Flip-chip Modules (D213.80); LSI 11
 Module (D35.80); PDP-6 System
 Logic Module; PDP-8/1 Logic Module
 (D220.80); PDP11/20 Module Artwork
 (D22.79); System Building Block
 (D203.80); UART Four Channel
 Asynchronous Serial Interface
 (D36.80); VAX Prototype UBA
 (D166.80)
*Gifts of Digital Equipment
 Corporation*

Digital Equipment Corporation,
 PDP-5 Accumulator Boards (X21.81)
Gift of David Razler

English Electric Company, Deuce
 Arithmetic Logic Element (XD4.75)
Gift of Murray Allen

ENIAC Function Table
*On loan from the Smithsonian
 Institution, National Museum
 of History and Technology*

Fairchild Semiconductor,
 Semiconductor (X71.82)
Gift of Bob Glorioso

Ferranti Corporation, Atlas 1
 Printed Circuit Board (XD1.75);
 Atlas 1 Digits (XD2.75)
Gift of F. H. Sumner

Ferranti Corporation, Atlas 1 Four
 Flip-flop Board (X53.81); Mark I*
 Logic Door (X66.82)
*Gifts of Department of Computer
 Science, University of Manchester*

Ferranti Corporation, Atlas 1
 Printed Circuit Board (XD128.80)
Gift of Rutherford Laboratory

FUJITSU Ltd., Relay No. 56
 (XD71.79), Parametron (XD73.79),
 Logic Circuit Diagrams (XD77.79),
 FACOM 100 Relay (XD106.80)
Gifts of FUJITSU, Ltd.

General Dynamics Form Flash
 Plates from Stromberg Carlson
 SC4020 (XD131.80)
Gift of Rutherford Laboratory

General Electric, Semiconductor
 (X70.82)
Gift of Bob Glorioso

Honeywell Sense Amplifier
 H4200/8200 (XD253.81)
Gift of Phil Goldman

International Business Machines
 Corporation, 22XX Printer Buffer
 Array, Logic card from an IBM
 Printer (XD132.80)
Gift of Rutherford Laboratory

International Business Machines
 Corporation, IBM 360/91 Console
 (X73.82)
*Gift of Howard Eskin, Columbia
 University*

International Business Machines
 Corporation, IBM 650 Logic Module
 (XD12.75)
Gift of Murray Allen

International Business Machines
 Corporation, SMS Logic Module
 (D113.80)

Manchester University, Mark I Valve
 (XD5.75)
*Gift of Department of Computer
 Science, Manchester University*

MIT, Altair 8800 CPU Board (X6.80)
Gift of Ed Luwish

Motorola, Semiconductor (X68.82)
Gift of Bob Glorioso

National Union, Vacuum Tubes
 (X76.80)
Gifts of Gary Papazian

Philco, Transistors (X64.82)
Gifts of Bob Glorioso

Raytheon, Electron Tubes (X74.82)
Gifts of Gary Papazian

Raytheon, Power Transistor 2N1662
 (X59.82)
Gift of Bob Glorioso

RCA, Radio and Electron Tubes
 (X75.80)
Gifts of Gary Papazian

RCA, Transistors (X72.82)
Gifts of Bob Glorioso

SDS-SD Sales, S-100 CPU Board
 (XD236.81)
Gift of David Ramsperger

Sylvania, MOBIDIC Logic Board
 (XD192.80)
Gift of Frank Feigin

Texas Instruments, Semiconductors
 (X61.82)
Gifts of Bob Glorioso

Transitron, Diodes (X63.82);
 Semiconductor (X69.82)
Gifts of Bob Glorioso

University of Illinois, ILLIAC II
 BLOCK Multiplexor called
 "Interplay" (XD216.75); ILLIAC III
 Printed Circuit Module
Gifts of Clifford Carter

Westinghouse, RTL Integrated
 Circuits (X62.82)
Gifts of Bob Glorioso

This 1953 transistor had its own serial number and was individually packaged. The tube was indented to hook the transistor over the side and keep its "whiskers" from becoming bent.

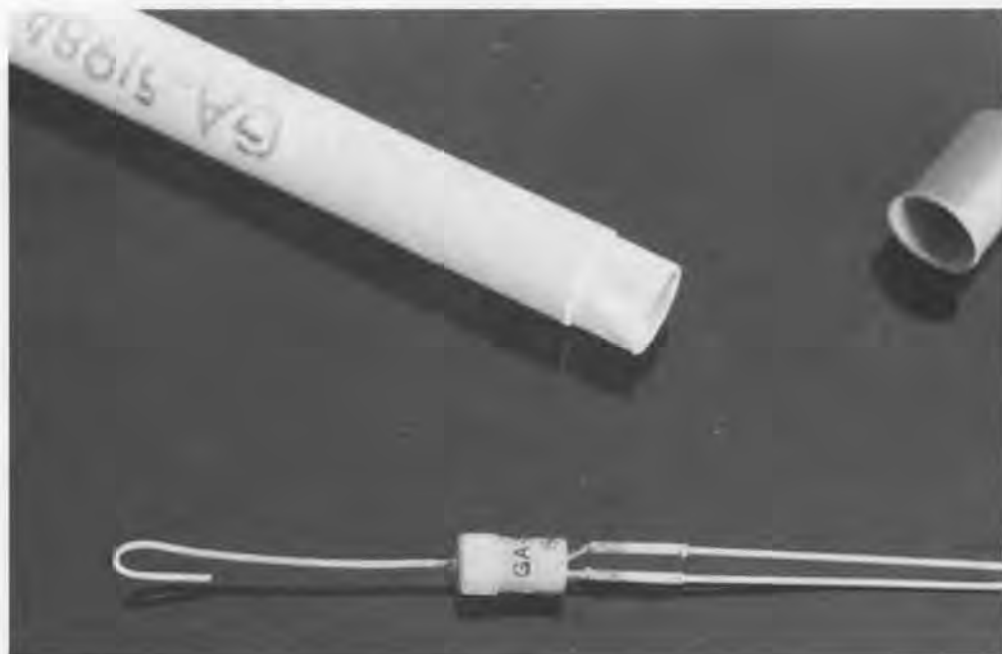

Bunnell, Telegraph Sender and Receiver (XD229.80)
Gift of Rodney Bamford
 Harold Cohen, "Turtle" (X50.82)
On loan from Harold Cohen
 Columbia Graphophone Company, Dictaphone, Shaver, Transcriber (D123.79)
 Digital Equipment Corporation, Type 30A CRT (X25.81)
Gift of Harvey Wiggins
 Digital Equipment Corporation, 338 Display Unit (X23.81)
Gift of Ford Motor Company
 Digital Equipment Corporation, GIGI (D276.82); GT-40 (D10.81); VT 105 (X36.81)
Gifts of Digital Equipment Corporation
 Digital Equipment Corporation, VT 105 (X36.81)
Gift of American Computer Group Inc.
 Allen B. Du Mont Laboratories, Inc., Cathode-Ray Oscillographs (X26-8.81)
Gifts of Ken Olsen
 Edison Company, Ediphone, Utility Shaver and Voice Recorder (D121.80)
 "Enigma" (B197-8.81)
On loan from Gordon and Gwen Bell

Friden Corporation, Friden Paper Tape Reader (X9.80)
Gift of Ed Luwish
 International Business Machines Corporation, IBM Card Punch (X40.80)
 International Business Machines Corporation, IBM Auto-typist Perforator and Printer (X16-7.81)
Gifts of Solomon Schechter Day School
 International Telephone and Telegraph, Teletype (D117.80)
Gift of Jack Brown
 C. Lorenz A-G, Telegraph Transmitter (X30.81)
Gift of Alexander Vanderburgh Jr.
 Martin Marietta Corporation, Clary Printer adapted for computer output (XD208.80)
Gift of Clyde Still
 The Noiseless Typewriter Company, "Noiseless Typewriter" (X5.80)
Gift of Ed Luwish
 The Noiseless Typewriter Company, "Noiseless Typewriter" (X18.81)
Gift of Trudy Leonard
 Railroad Telegraph Transmitter (XD182.80)
Gift of Cliff Granger
 Remington Rand, UNIVAC Card Punch (X34.81)
Gift of National Museum of Science and Technology, Ottawa

Telegraphen-Bau-Anstalt von Siemens and Halske, Needle Telegraph (X19.81)
On loan from Siemens Corporation
 Signal Electric Manufacturing Company, "Signal Telegraph Instrument" (B164.81)
Gift of Gordon and Gwen Bell
 Teletype Corporation, Model 19 Teletypewriter (XD159.80)
Gift of Dick Eckhouse
 Triadex Inc., "The Muse" (XD254.81)
Gift of Ed Fredkin
 Western Electric, Telephone (X32.81)
Gift of Daniel Rizzo
 Western Electric, Telephone (X56.80)
Gift of James Parker



"ZZZ German Order of Battle according Commander-in-Chief on 27th (A.) 14 Army, Coast, Right Wing of Bridgehead now only guarded . . ." A top-secret message from Field Marshal Kesselring, supreme commander of the German forces in Italy, to Berlin. Originally encoded on the "Enigma" (similar to the one shown), the message was deciphered by code-breakers at Bletchley Park within hours of transmission. The critical importance of code-breaking led the British to fund computational development during World War II.

- Abacus (B93.80)
Gift of Gordon and Gwen Bell
- ADDI-COSMOS, "B.U.G. Calculator" (B131.80)
On loan from Gordon and Gwen Bell
- Aeroproducts Research, Inc., Flight Plan Calculator (X55.82)
On loan from Steve Kallis
- R. C. Allen, "ARITHMA" (XD125.80)
Gift of Arthur Hall III
- American Can Company, "American Adding Machine" (B180.81)
Gift of Gordon and Gwen Bell
- Anita, Electronic Calculator (XD209.80)
Gift of Leonard Woodall
- Atanasoff-Berry Computer Breadboard (X12.80)
On loan from John Vincent Atanasoff
- Automatic Adding Machine Company, "Golden Gem Adding Machine" (X2.81)
Gift of Erwin Tomash
- Bell Telephone Laboratories Calculator, prototype adder reproduced by George Stibitz (XD127.80)
Gift of George Stibitz
- Bohn Contex, Desk Calculator (X43.81)
Gift of Bob Olthoff
- Brical Pocket Adding Machine (X13.80)
On loan from Dick Rubinstein
- "Circular Concise Slide Rule" (B114.80)
Gift of Gordon and Gwen Bell
- Clary Corporation, Clary DE600 (X35.81)
Gift of Lee McKusick
- Colossus Narrow Tape Pulley (X49.81)
Gift of Toby Harper
- Contina Ag Mauren, "Curta" (B87.79)
Gift of Brian Randell
- Drawing Instruments ca 1850 (B106.80)
On loan from Gordon and Gwen Bell
- Dring and Fage, Inland Revenue Slide Rule (B55.80)
On loan from Gordon and Gwen Bell
- Dring and Fage, "Leadbetter Slide Rule" (B108.80)
Gift of Gordon and Gwen Bell
- Hans W. Egli, "Millionaire" (B1.75); (B136.81)
On loan from Gordon and Gwen Bell
- Hans W. Egli, "Millionaire" (B91.76)
Gift of Gordon and Gwen Bell
- "EXACTUS" (B36.79)
Gift of Gordon and Gwen Bell
- Fowler and Company, "Fowler's Textile Calculator" (B112.80)
On loan from Gordon and Gwen Bell
- J. F. Fuller, "Palmer's Improved by Fuller Computing Scale" (B110.80)
Gift of Gordon and Gwen Bell
- J. F. Fuller, "Palmer's Improved by Fuller Computing Scale" (X1.81)
Gift of Erwin Tomash
- General Precision Systems, General Purpose Analog Computer (X42.79)
Gift of Lincoln-Sudbury Regional High School
- Gunter Rule (B41.79)
Gift of Gordon and Gwen Bell
- Gunter Rule (B4.76)
On loan from Gordon and Gwen Bell
- Hewlett Packard, "HP-35" (B34.79)
Gift of Gordon and Gwen Bell
- The Hollerith Electric Tabulating System, Reproduction by Roberto Guatelli (D231.81)
Gift of Digital Equipment Corporation
- Jacquard Loom Mechanism (B117.80)
On loan from Gordon and Gwen Bell
- Keuffel & Esser, Slide Rule (XD50.76)
Gift of Dick Clayton
- Keuffel & Esser, "Thacher's Calculating Instrument" (B56.80)
On loan from Gordon and Gwen Bell
- C & E Layton, "Tates Arithmometer" (B82.80)
On loan from Gordon and Gwen Bell
- Lewis & Tylor, Ltd., "Hydra-calculator" (B113.80)
Gift of Gordon and Gwen Bell
- L. I. D., Timber Calculating Slide Rule (B30.77)
On loan from Gordon and Gwen Bell
- Lightning Portable Adding Machine from the desk of George Forsythe (X15.81)
Gift of Gio C. M. Wiederhold
- Marchant Electric Calculator (XD235.81)
Gift of Robert Floyd
- Navigator's Gunter Rule (B54.80)
On loan from Gordon and Gwen Bell
- Navigator's Sector (B21.78)
On loan from Gordon and Gwen Bell
- Aaron Palmer, "Palmer's Pocket Scale" (B194.81)
On loan from Gordon and Gwen Bell
- Pascal Adder, Reproduction by Roberto Guatelli (B150.81)
On loan from Gordon and Gwen Bell
- Frederick Post Company, "Versalog Slide Rule" (X47.81)
Gift of Cliff Hafen Jr.
- Powers Samas Card Processing System (XD14.81)
Gift of the Biological Research Centre, Institute of Terrestrial Ecology
- Precision Adding Machine Company, Inc., "Quixsum Adding Machine Model C" (B38.79)
On loan from Gordon and Gwen Bell
- Raytheon, Hawk Missile Auto Pilot (XD144.80)
Gift of Joe Kuprevich
- Reliable Typewriter & Adding Machine Corporation, "Addometer" (B85.79)
Gift of Gordon and Gwen Bell
- J. Sang, "Platometer" (B6.76)
On loan from Gordon and Gwen Bell
- Selective Educational Equipment Corporation, "SEE CALCULATOR" (B31.79)
- Servo Calculator Company, "Direct Reading Frequency Response Slide Rule" (X3.81)
Gift of Jack Worlton
- Stanley Rule & Level Company, Timber Slide Rule (B99.80)
Gift of Gordon and Gwen Bell
- M. Thomas de Colmar, "Arithmometer" (B3.76)
Gift of Gordon and Gwen Bell
- M. Thomas de Colmar, "Instruction pour se servir de L'Arithmometre Machine a Calculer" (X4.81)
Gift of Erwin Tomash
- J. Thomlinson, Ltd., "Thomlinson's Equivalent Paper Slide Rule" (B107.80)
Gift of Gordon and Gwen Bell
- Texas Instruments, Slide Rule Calculator (XD237.81)
Gift of Mike Riggle
- Tinker Toy Computer (X39.81)
Gift of Danny Hillis, Brian Silverman and friends
- Wolverine Supply and Manufacturing Company, "Adding Machine" (B167.81)
Gift of Gordon and Gwen Bell



The Pascaline (1645) is the first mechanical, single register calculator built that is still in existence. Roberto Guatelli reproduced this copy from an original in the collection of Thomas Watson stored by IBM. The calculator was designed by Blaise Pascal, the famous French scientist and

philosopher, at the age of 19. Although a number were built during his lifetime, the tooling was such that they were unreliable, and became curiosities as much as calculators. The principles of Pascal machines were later applied to key punch calculators such as the Comptometer.

- Atanasoff-Berry Computer Memory Drum (X11.80)
On loan from Dr. Clair Maple
Autonetics, Minuteman Fixed Head Disk Memory (XD107.80)
Gift of Aron Insinga
Bryant Computer Products, RM-10 Drum (X51.82)
Gift of Nigel Webb
Bubble Memory System (D8.81)
Gift of Nick Warchol
Richard Stevens Burrington, "Handbook of Mathematical Tables and Formulas" (B44.79)
Gift of William B. Lehmann
CCD Memory Board (D7.81)
Gift of Nick Warchol
Chemical Rubber Publishing Company, "Handbook of Chemistry and Physics, 31st Edition" (B28.79)
Gift of Gordon and Gwen Bell
Computer Controls Corporation, Delay Line Memory/Logic Module (D108.80)
Control Data Corporation, CDC 38500 Cartridge (XD222.80)
Gift of Lawrence Livermore National Laboratory
Digital Equipment Corporation, Core Memory (D200.80); 18 mil Planar Memory (D198.80); Experimental Ferrite Memory Stack (D160.80); PDP-11 Planar Structured Core Memory (D241.80); 64K Byte Memory Module (D34.80); VAX SBI Memory Board (D164.80); VAX Star 64K MOS Memory Array (D165.80)
Gifts of Digital Equipment Corporation
Disk Drive Prototypes (X52.82)
Gift of Steve Lambert
The Emeloid Company, Inc., "Transmission Line Calculator" (X29.81)
Gift of Cliff Hafen Jr.
- English Electric Company, Deuce Mercury Delay-line (XD3.75); Deuce Memory Drum (X65.82)
Gifts of Murray Allen, University of Sydney
Ferranti Ltd., Atlas 1 Fixed Memory (XD129.80); Atlas 1 Memory "The Supervisor" (XD130.80)
Gift of Rutherford Laboratories
Ferranti Ltd., Magneto-strictive Delay-line (XD230.80)
Ferranti Ltd., Pegasus Short Acoustic Delay-line (X54.82); Williams Tube (X67.82)
Gifts of Computer Science Department, Manchester University
Ferroxcube Corporation of America, Ferroxcube Core Memory (D195.80)
FUJITSU Ltd., Hollerith Read Only Card Reader and Cards (XD74-5.79); Paper Tape for FACOM (XD76.79)
Gifts of FUJITSU Ltd.
Harvard University, Mark IV 64-bit Magnetic Shift Register (XD6.75)
Gift of Bob Trocchi
Hertrich Development Inc., RL01 Disk Drive Prototype (XD163.80)
Gift of Fred Hertrich
Honeywell Memory Sense Amplifier (X22.81)
Gift of Phil Goldman
Honeywell Plated Wire Memory (D114.80)
Charles Hutton, "Table of the Products and Numbers" (B2.76)
On loan from Gordon and Gwen Bell
International Business Machines Corporation, 2321 Data Cell Drive (X46.82); 2321 Data Strips (XD219.80); Data Cell (XD220.80); 1360 Photo-digital Storage System (XD221.80)
Gifts of Lawrence Livermore National Laboratory
- Los Alamos Scientific Laboratory, MANIAC Electrostatic Memory and Williams Tube (XD214.80)
Gift of Los Alamos Scientific Laboratory
Mermod Freres, Piano Disk (XD136.80)
Gift of Marv Horovitz
MITS, Altair 4K RAM Board (X7.80)
Gift of Ed Luwish
"Model Ready Reckoner" (X57.80)
Gift of McLaren Harris
Napier's Bones (B27.79)
On loan from Gordon and Gwen Bell
NASA Apollo Guidance Computer Read Only Rope Memory (XD115.76)
Gift of Albert Hopkins
Phillips, Ferroxcube FFI (D204.80)
RCA, Core Memory Board (XD197.80)
Gift of Gary Papazian
RCA, Experimental Ferrite Core Memory (D161.80); Thin Film Memory (D112.80); Non-destructive Read-out (D162.80)
RCA, Ferrite Core Memory Cube (D169.80)
Gift of Cliff Granger
RCA, JOHNNIAC Selectron Tube (XD215.80)
Gift of John Postley
"Sumador Chino" (X10.80)
Gift of Jim Rogers
3 M Corporation, Telex Disk (D80.80)
Gift of Don Sordillo
University of Illinois, ILLIAC II 48-bit Register, Mesa Transistor (XD120.80)
Gift of Los Alamos Scientific Laboratory

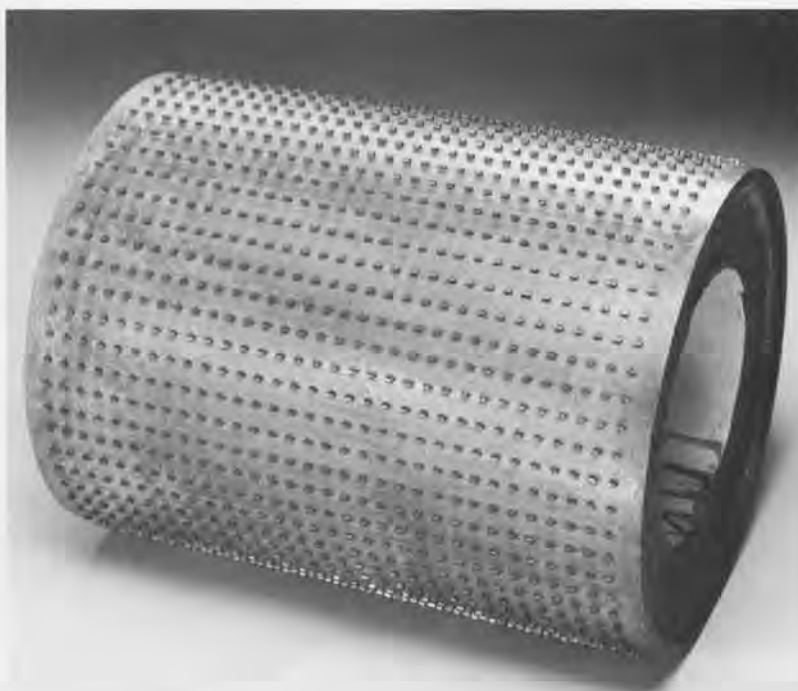

This drum is the only remaining portion of the Atanasoff-Berry Computer, the first electronic, digital calculator. Two drums were built, each with 32 50-bit tracks of small paper condensers, with the outer end connected to a contact stud and the inner ends connected together and brought out through the mounting plates. The space near the periphery, in which the condensers are mounted, contains a high grade of wax for moisture protection. A positive charge on the outer end of a condenser corresponds to zero, a negative charge to one. The drum rotates on an axis at a speed of one revolution per second. Brushes bear upon their contacts to read the charges and recharge them.

Michael Adams	IBM, Corporate Exhibit Program and Corporate Archives	A.H.J. Sale
John Vincent Atanasoff	INTEL	Grant Saviers
Gordon Bell	Jack Kilby	Hrand Saxenian
Charles and Constance Bachman	Lawrence Livermore National Laboratory	Science Museum, London
Bell Laboratories	Los Alamos Scientific Laboratory	Oliver Selfridge
Brigham Young University, Computer Services	Dick Loveland	Shelburne Museum
British Telecom Research Laboratories	Massachusetts Computer Associates, Inc.	Siemens Corporation
Arthur W. Burks	Massachusetts Institute of Technology Museum and Historical Collections	Richard Solomon
Wesley Clark	The MITRE Corporation, Corporate Archives	George Stibitz
Harold and Becky Cohen	Monroe Systems for Business	Ivan Sutherland
Steve Cooper	National Physical Laboratory	John A. Swets
David Edwards	Princeton University, Institute for Advanced Studies	Texas Instruments
Digital Equipment Corporation, Corporate Library	Brian Randell	University of Manchester, Department of Computer Science
Charles Stark Draper Laboratory	Charles Ray	Gordon Welschman
Wayne Galusha	Bob Reed	James Wilkinson
Jack Gilmore	Dick Rubinstein	Konrad Zuse
C. Lester Hogan	Rutherford Laboratory	

Maurice Wilkes spoke at the inauguration of the first exhibits, September 23rd, 1979. The eleven other lectures given to date include nine by people closely associated with the machines featured on the Pioneer Computer Timeline, one on the Computer Murals and one on the LINC. These lectures were recorded on video-tape for the Museum's archives. Six major lectures relating to the exhibitions at the Museum are planned each year.

Harold Cohen, September 23, 1980
The Program and Art behind the Museum's Murals

"Deep down inside I told myself my real pre-occupation has been not games having to do with how you generate patterns but with games of meaning. How do you come to terms with the curious issue of imagery in artmaking?"

"The people at Stanford couldn't understand at all why I was using up all this computer time making all these funny squiggles."

Harold Cohen painting "Primavera in the spring," September 1980.

Photo by Becky Cohen.



Wesley Clark, November 18, 1981
The Design, Building, and Use of the First Laboratory Computer: LINC

"The concept of putting this in one box that an experimenter could take away to his laboratory and work with in a personal way was the essence of it."

"One fellow looked at the LINC inside and out, and at this wire going over and to the other side. Then said, 'This thing can't possibly work, there is no way to get the data in.' He couldn't find any punched cards. We went back to Lincoln Laboratory exhausted but triumphant, wanting to do more."

Wesley Clark and Charles Molnar recreating a classic pose with the LINC at the Museum.

Maurice Wilkes, September 23, 1979
The Design and Use of the EDSAC

"We realized that building the machine was only the start of the project; that there was a great deal to be learnt about writing programs, about how to use the machine for numerical analysis, numerical calculation, and all the rest of it"

"As soon as we started programming, we found to our surprise that it wasn't as easy to get programs right as we had thought. Debugging had to be discovered. I can remember the exact instant when I realized that a large part of my life from then on was going to be spent in finding mistakes in my own programs."



Jay Forrester, June 2, 1980
The Design Environment and Innovations of Project Whirlwind

"The Whirlwind experience was a very good beginning because we learned the problems of pioneering, we learned the need for courage to stand up for what you believe."

"Magnetic core storage, marginal checking, high reliability, cathode-ray displays, light gun, and a kind of time-sharing were all part of Whirlwind."

Jay Forrester



John Vincent Atanasoff, November 11, 1980
The Forces that Led to the Design of the Atanasoff-Berry Electronic Calculator

"I soon found that no machine or system available could solve the growing lists of problems of theoretical physics, technologies, statistics, or business."

"There I was in 1936, turning my mind to invent a digital machine, not knowing how it would be built or how it would work. . . . In a larger sense no man invents anything; he builds and extends a little with his friends and on the shoulders of others."

John Vincent Atanasoff



George Stibitz, May 8, 1980
The Development, Design and Use of the Bell Laboratories Relay Calculators

"In 1939, it was funny to think of a machine that calculated in the ancient binary notation. I wasn't sure whether the idea was funny or not, and for several weeks I thought it over, drawing circuits at home for a real calculator with desk-top capabilities."

George Stibitz presenting his talk.

Konrad Zuse, March 4, 1981
Designing and Developing Z1 - Z4

"At that time, nobody knew the difference between hardware and software. We concentrated ourselves on purely technological matters, both logical design and programming."

Zuse illustrating the structure of the Z1 through Z4



James Wilkinson, April 14, 1981

The Design and Use of the Pilot ACE

Right from the very start, Turing was very obsessed with getting the maximum possible speed. That wasn't the popular view at the time."

James Wilkinson, with Charles Cullinane, Charles Bachman, Maurice Wilkes, and Gordon Bell



David Edwards, September 9, 1981

The Evolution of the Early Manchester Machines

"F. C. Williams's contribution was that he recognized that if you looked at the patterns on the face of a tube after a millisecond, you could recognize what they were, and in looking at them you wrote them back again."

"In June 1948, when the baby machine ran, our confidence started to develop."

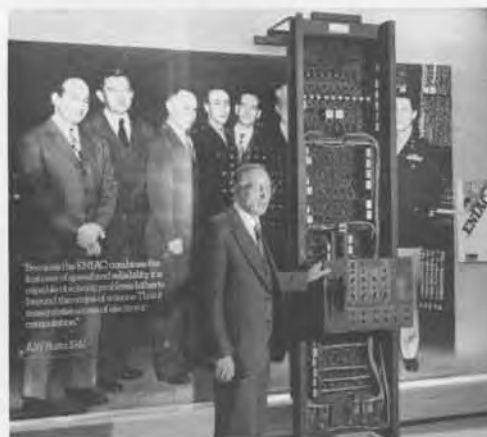

Arthur Burks, February 18, 1982

The Origin of the Stored Program

"This most important historical achievement [the stored program] did not come about in a straightforward way, but in a convoluted, indirect manner."

Arthur Burks and the function table of the ENIAC.



T. H. Flowers, October 15, 1981

Design and Use of Colossus

"During World War II, I became involved in code-breaking activities for which I conceived and built machines which became known as Colossus. Colossus had features now associated with digital computers—semi-permanent and temporary data storage, arithmetic and logic units including branching logic and variable programming."

T. H. Flowers

John Brainerd, June 25, 1981

Development of the ENIAC Project

"It was the world's first large-scale digital electronic general purpose computer. You have to put all those words in to tell something about it."

John Brainerd speaking of the impact of the Differential Analyzer.



Individuals are encouraged to participate in the activities of the Museum by becoming members. Kitty Selfridge is serving as the first chairman and Ed Galvin as the secretary. The membership group meets quarterly to coordinate activities. Committees have been formed to advise on the museum store (Dick Rubinstein and Carolyn Sweeney), excursions (Joan Lyle), and accessibility for the handicapped (Sandra VanHorn). Other committees will be developed as needs arise.

Members are encouraged to learn enough about the structure of the collection to guide tours. The Museum staff and certified docents provide scheduled training sessions. Present docents include Gordon Bell, Larry Cade, Steve Carter, Bruce Collier, Vernon Johnson, Ed Luwish, Jack Lucier, Ira Machefsky, Brian Randell, Dick Rubinstein, Peggy Sullivan, Rod Sutherland, Juanita Thiel, and Maurice Wilkes.

CORPORATE MEMBERS

Carnegie Mellon University
Computer Design Publishing
Intermetrics, Inc.
E. B. Luce Corporation
S. & H. Computer, Inc.
Valid Logic Systems, Inc.
Wang Laboratories
WCRB Sound Systems Inc.

MEMBERS

Mark C. Allen	Clifford H. Hafen Jr.	James L. Rogers
Donald R. Ames	William Hanson	Robert F. Rosing
Victor Andersen	Walter Hanstein	Richard Rubinstein
Bob Armstrong	Phil Harler	Charles Rupp
Mario R. Barbacci	Samuel D. Harper	Martin I. Sack
Lamar C. Bevil Jr.	Michael Hathaway	Jean E. Sammet
Rika Brademann	William Heffner	Hrand Saxenian
Brown University, Computer Science Department	Dan Hlozik	Edward H. Schein
Alice Burks	Lawrence L. Holmes	Andrew Schmidt
Arthur W. Burks	Grace M. Hopper	Stanley W. Schultz
Max Burnet	Dieter Huttenberger	Jack Schwartz
Richard C. Campbell	Aron Insinga	William W. Schweikert
George A. Champine	Howard W. Johnson	Ramon C. Scott
Bobby Choonavala	Anita K. Jones	Andrew Seidel
Peter R. Clemons	Ray Kaplan	Marc Shulman
Bruce Collier	Bill Keating	Daniel P. Siewiorek
F. J. Corbato	Marcia M. Kenah	Thomas M. Smith
David Corbishley	Alan Kotok	Steven Stepanek
Gerald Davis	Hal Lamster	William M. Steul
James S. Davis	Michael P. LaVigna	Jack H. Stevens
Jack Dennis	Arthur T. Leung	Randall L. Stickrod
Stephen H. Dodd Jr.	Ann W. Lewin	J. Michael Storie
R. C. Dungavell	Arthur Luehrmann	Julius Stratton
Dick Dunnington	Joan Lyle	Margaret A. Sullivan
Joseph H. Eachus	Ira S. Machefsky	Nathan Teichholtz
J. R. Ebright	Massachusetts College of Art	Alexander Vanderburgh Jr.
Dick Eckhouse	Ruth Maulucci	James A. Wade
Andrew Eskind	Pamela McCorduck	W. Gordon Welchman
Robert M. Fano	James L. McKenney	David P. Wheatland
Sidney Fernbach	John A. McKenzie	Maurice Wilkes
Aaron Finerman	John E. McNamara	James W. Woods
Adrian J. Flatgard	Bill Minasian	William A. Wulf
Mary Jane Forbes	David Murphy	
Bernard A. Galler	Allen Newell	
Willard H. Gardner	John F. Nolan	
David W. Gault	Eldon Norton	
William Gervais	Anthony G. Oettinger	
Ray Giordano	Anthony D. Pell	
Rose Ann Giordano	Edward G. Perkins	
Robert Glorioso	Carol Peters	
John P. Gray	Montgomery Phister Jr.	
Sheila Grinell	Robert W. Rector	
	Kent C. Redmond	
	J.E. Richardson	
	C. Mike Riggie	
	Alan J. Roberts	

Until June 1984, when the Museum will have completed all the requirements for full status as a Charitable Foundation under Public Law 501(c)3, the opportunity exists for individuals and institutions to become Founders.

During these two years, we are seeking to develop a broad base of support from Corporations and Individuals involved with information processing. Corporate Founders (\$2500) and individual Founders (\$250) receive certificates and all privileges of membership.

This is a unique opportunity to help establish the only international museum devoted exclusively to computers and computing history.

CORPORATE FOUNDERS

Bolt, Beranek and Newman Inc.
Robert Cipriani Associates
ComputerWorld
Control Data Corporation
Clint Clemens
Data General
Digital Equipment Corporation
General Systems Group, Inc.
MITRE Corporation
Schlumberger Foundation
Tobin Vending Service

FOUNDERS

Gene M. Amdahl
Charles Bachman
Chester and Hurshel Bell
Gordon Bell
Gwen Bell
A. M. Bertocchi
Gordon S. Brown
Lawrence C. Brown
Peter Christy
Henry J. Crouse
James G. Cudmore
Henri G. Doll
Tom Eggers
M. Gordon Ehrlich
Ulf and Helene Fagerquist
John T. Gilmore Jr.
Mr. and Mrs. Gruzinov-
Henderson
Roberto Guatelli
Theodore G. and Ruth T.
Johnson
Jerrier Haddad
Winston R. Hindle Jr.
C. Lester Hogan
A.L.C. Humphreys
J. S. Kilby
Edward A. Kramer
Thomas Marill

Daniel D. McCracken
Mr. and Mrs. William H.
McLean
J. Craig Mudge
Susannah Nathan
Joseph M. Newcomer
Jeremy M. Norman
Robert Noyce
Kenneth H. Olsen
Robert M. Price
Ronald Resch
Fontaine K. Richardson
Grant Saviers
Oliver and Kitty Selfridge
Alan F. Shugart
Richard Sites
Edward A. Schwartz
John J. Shields III
Ivan and Marcia Sutherland
Delfina and Stephen Thorndike-
Teicher
James E. Thornton
Erwin O. Tomash
Michael G. Tomasic
Arnaud de Vitry
Jerome B. Wiesner
Leonard Woodall



Digital
Computer
Museum

MUSEUM EVENTS

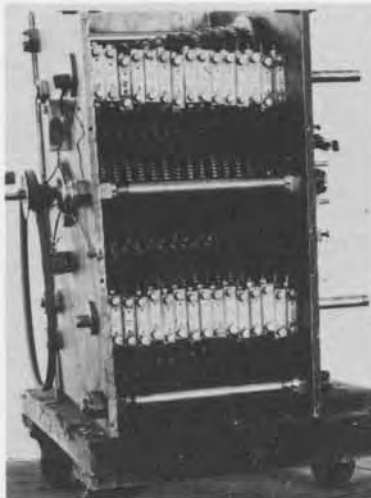

Wednesdays at 4 and
Sundays at 3

GALLERY TALKS AND WALKS

Special topics will be announced each week.

October 7 at 5 PM

LECTURE: HISTORY OF THE SIEVE MACHINES

D. H. Lehmer

Professor Emeritus University of California at Berkeley. With an exhibition of the electro-mechanical machine used for finding prime numbers exhibited at the Chicago World's Fair of 1932 and the 1950 electronic prime number sieve.



October 8-9

EXCURSION: ANFSQ7 and NATIONAL MUSEUM OF SCIENCE AND TECHNOLOGY

Friday noon leave Hanscom Field for North Bay, Canada. Visit and tour the ANFSQ-7, vacuum tube computer in operation on the SAGE early warning system. Hotel accommodations in Ottawa. Saturday morning tour of the Computing Exhibition, National Museum of Science and Technology. Saturday noon leave Ottawa for Hanscom Field, Bedford. Contact Chris Rudomin for more information.



October 22 at 5 PM

LECTURE: THE WATSON SCIENTIFIC LABORATORY, 1945-50

Herbert J. Grosch

As the first assistant to Wallace Eckert and director of the computing program, Herbert Grosch will provide a narrative of the development of the Columbia Laboratories up to the time of NORC.

CONTENTS

- 1 THE DIRECTOR'S LETTER
 - 4 COLLECTIONS OF THE DIGITAL COMPUTER MUSEUM
 - 11 LECTURE SERIES
 - 14 MUSEUM MEMBERSHIP
 - 15 FOUNDERS PROGRAM
- MUSEUM EVENTS



THE COMPUTER MUSEUM REPORT

FALL/1982



VACUUM TUBE POWER DRIVER FOR THE
FIRST CORE MEMORY, WHIRLWIND COMPUTER, 1951.
INTEGRATED CIRCUIT MODULE PROTOTYPE,
APOLLO GUIDANCE COMPUTER, 1965.

CONTENTS

- 1 **The Director's Letter**
- 2 **The Apollo Guidance Computer**
 - A Designer's View – Eldon Hall
 - A User's View – David Scott
 - Comments – Dr. Charles S. Draper
- 8 **Whirlwind Before Core**
Jack Gilmore
- 9 **Portrait of a Board Member**
C. Lester Hogan
- 10 **Museum News**
 - Opening Celebration
 - Archives and Library
 - Intern Program
 - Summer Gallery Talks
 - Members' Association
 - New Founders
- 13 **The Computer Historian's Bookshelf**
- 17 **Future Museum Lectures**



THE COMPUTER MUSEUM

The Computer Museum is a non-profit, public, charitable foundation dedicated to preserving and exhibiting an industry-wide, broad-based collection of the history of information processing. Computer history is interpreted through exhibits, publications, videotapes, lectures, educational programs, and other programs. The Museum archives both artifacts and documentation and makes the materials available for scholarly use.

The Computer Museum is open to the public Sunday through Friday from 1:00 to 6:00 pm. There is no charge for admission. The Museum's lecture hall and reception facilities are available for rent on a prearranged basis. For information call 617-467-4443.

Museum membership is available to individuals and non-profit organizations for \$25 annually and to businesses for \$125 annually. Members receive the quarterly Report, invitations to all lectures and special programs, new posters, and a ten percent discount in the Museum store.

A Founders program is in effect during the initial two-year period of the Museum, until June 10, 1984. During this period individuals and non-profit organizations may become Founders for \$250 and businesses and charitable Foundations may become Founders for \$2500. Founders receive all benefits of membership and recognition for their important role in establishing the Museum.

THE COMPUTER MUSEUM REPORT

The Computer Museum Report is published quarterly by The Computer Museum, One Iron Way, Marlboro, MA 01752. Annual subscription is part of the membership of the Museum (\$25 per year for individuals and nonprofit organizations and \$125 for corporations).

The purpose is to report on the programs and exhibitions of the Museum. The contents of The Computer Museum Report may not be reproduced without written consent.

The Museum Staff is responsible for the contents of the Report. The opinions expressed do not necessarily represent those of The Computer Museum or its Board of Directors.

The design and production of the Report is done by Benson and Clemons.

BOARD OF DIRECTORS

Kenneth H. Olsen, Chairman
Digital Equipment Corporation

Charles Bachman
Cullinane Associates

C. Gordon Bell
Digital Equipment Corporation

Gwen Bell
The Computer Museum

Harvey D. Cragon
Texas Instruments

Robert Everett
The Mitre Corporation

C. Lester Hogan
Fairchild Camera and Instrument Corporation

Theodore G. Johnson
Digital Equipment Corporation

Andrew C. Knowles, III
Digital Equipment Corporation

John Lacey
Control Data Corporation

Pat McGovern
ComputerWorld

George Michael
Lawrence Livermore Laboratories

Robert N. Noyce
Intel

Brian Randell
University of Newcastle-upon-Tyne

Edward A. Schwartz
Digital Equipment Corporation

Michael Spock
The Children's Museum of Boston

Erwin O. Tomash
Dataproducts (retired)

The Honorable Paul E. Tsongas
U.S. Senator from Massachusetts

STAFF

Gwen Bell
Director

Jamie Parker
Exhibit Coordinator

Christine Rudomin
Program Coordinator

Gregor Trinka-Randall
Archivist

Jay McLeman
Computer Technician

John McKenzie
TX-0 Technician

Beth Parkhurst
Research Assistant

Sue Hunt
Administrative Assistant

The Computer Museum
One Iron Way
Marlboro, Massachusetts 01752
617-467-4036

©1982/THE COMPUTER MUSEUM

Photo Credits: pp. 4, 13, 17 (top and bottom), David Bromfield; pp. 1, 2, 7, 9, 10, 11, 14, Charles Collins; pp. 4, 5, 6, C. S. Draper Laboratory; Back cover, Data General Corporation; p. 8, Mitre Corporation.

Cover photo of vacuum-tube power driver of the first core memory of Whirlwind, 1953, and integrated circuit module prototype, Apollo Guidance Computer, 1965 by Clint Clemens. The photo is available as a full color poster (20 x 30 inches) \$4.00.

Since computer history is only now being written, the policy of the Museum is to develop evolving exhibitions. Thus, our galleries represent working drafts, allowing visitors to see the collections while we continue to supplement and revise them.

The Pioneer Computer Timeline was opened in October 1981. After it opened, artifacts that no one knew existed were unearthed. For example, Toby Harper, who worked on code-breaking at Bletchley Park, saw the Colossus photographs and remembered that he had one of the pieces from its tape feeding mechanism. He was going to use it as a telescope base that was never made.



Our display of Super Computers is especially dynamic. The collection of early machines is continuing, while we keep in mind today's computers that will be retired in the future. George Michael of Lawrence Livermore Laboratory, responsible for the donation of the CDC 6600 #1, is shown with Jamie Parker, Exhibit Coordinator, discussing the Cray I and future plans for the Super Computer exhibit.

The newest gallery, the Four Computer Generations, is organized to show the new inventions, first machines, new corporations, representative languages and applica-

tions characteristic of each period. After he saw the exhibition, Lester Hogan, one of the members of the Museum's Board of Directors, wrote a long letter with the following suggestions:

"I was particularly pleased with the handling of the history of 'the chip' by starting at Bell Labs and then mentioning the contributions of Dummer, Kilby and Noyce. I do, however, think it is important to emphasize the fact that dozens of researchers recognized that semiconductors offered the possibility of many transistors on a single chip and there was much more activity going on in various labs trying to find a really good method of building such a device than most people realize. In 1953, when a patent was issued to Syd Darlington, the general attitude at Bell Labs was that Syd was right and that this would happen someday but that it had to wait until we had a better way to make transistors. The alloy junction was indeed a better way and when it became a reality, Harwick Johnson at RCA Princeton took the concept even further and built a phase shift oscillator. Again, the general response was, 'Well, this is a lot better but it still isn't right.' Then Kilby took the concept of the diffused base mesa transistor even further. I remember my reaction was, 'Well, it's closer, but it still won't fly.' Then came Bob Noyce's suggestion using the planar process and we all ran very fast to bring that one process to reality."

The exhibition will be changed to reflect this evolutionary development.

As each exhibition nears stability, catalogs, slide sets, and other materials useful for reference and teaching will be produced to better serve our far-flung audience.

Gwen Bell
Director

The Apollo Guidance Computer

A Designer's View

Eldon Hall *Designer, Apollo Guidance Computer*

In the early sixties the so called mini-computer had not emerged and there was no commercial computer suitable for use in the Apollo mission. Most of the technologies that were eventually used in the Apollo computer were just emerging from research and development efforts. The design was mainly a task of fitting the components together in order to meet the mission requirements for computational capacity and miniaturization.

From Polaris to Apollo

Previous aerospace computers greatly influenced the development of the Apollo Guidance Computer. The demands that were placed on these computers provided the motivation to miniaturize and develop semiconductors. The MIT Instrumentation Lab, now called Charles Stark Draper Laboratory, had the

responsibility for the design of the computers used in the Polaris, Poseidon, and Apollo programs.

The lab's first significant venture into the field of digital computing was for Polaris, a very small ballistic missile launched from a submarine. A special purpose digital computer was designed to solve the specific equations required for the guidance and control system based on analog techniques originally developed by the Navy. With the need for increased accuracy the Navy decided to use digital techniques for the Polaris program, resulting in the construction of a wired-program special purpose computer to solve the guidance and control equations. In 1959 the first version of this system, called the Mark 1, flew in a Polaris missile. It was the first guided flight of a ballistic missile flown with an on board digital computer providing

the guidance and control computations. The computer occupied about four-tenths of a cubic foot, weighed 26 pounds, and consumed 80 watts. Even before this first guided flight designs were being explored which would reduce the size and improve the maintainability of the system. The new design, eventually designated Mark 2, repeated the architecture and logic design with improvements in circuits and packaging.

In August 1961, when NASA contracted the laboratory to develop the Apollo guidance, navigation, and control system, the mission and its hardware was defined in only very broad terms. A general purpose digital computer would be required to handle the data and computational needs of the spacecraft. Therefore a special arrangement of display and controls would be necessary for in-flight operations.

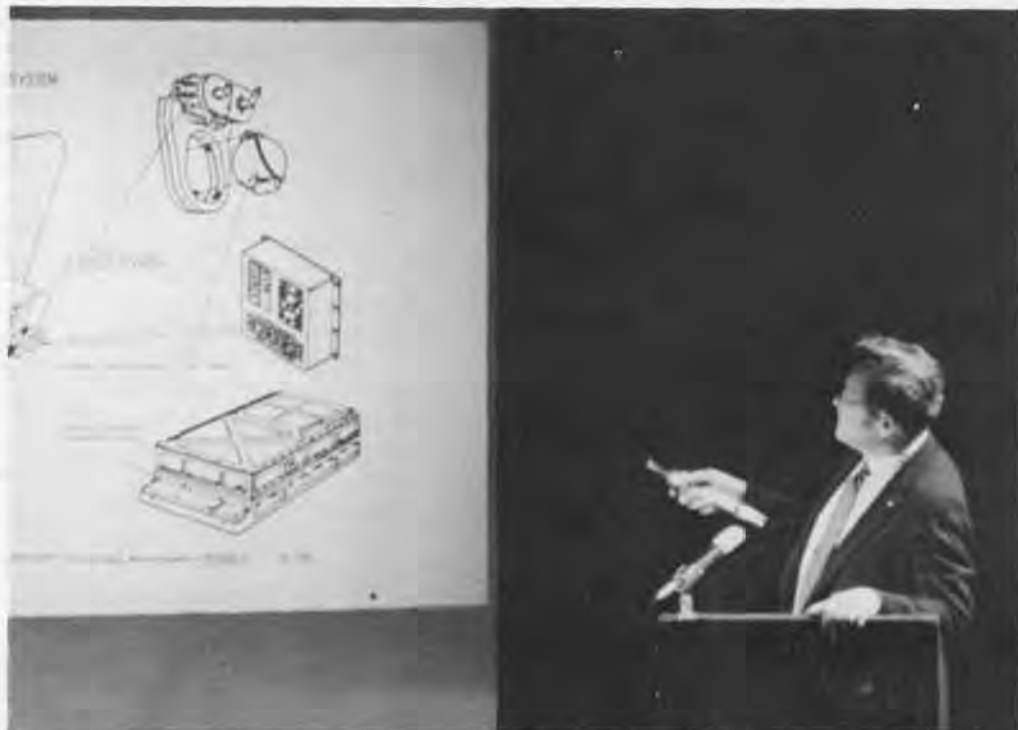

Eldon Hall pointing to one of the many diagrams shown during his illustrated lecture.

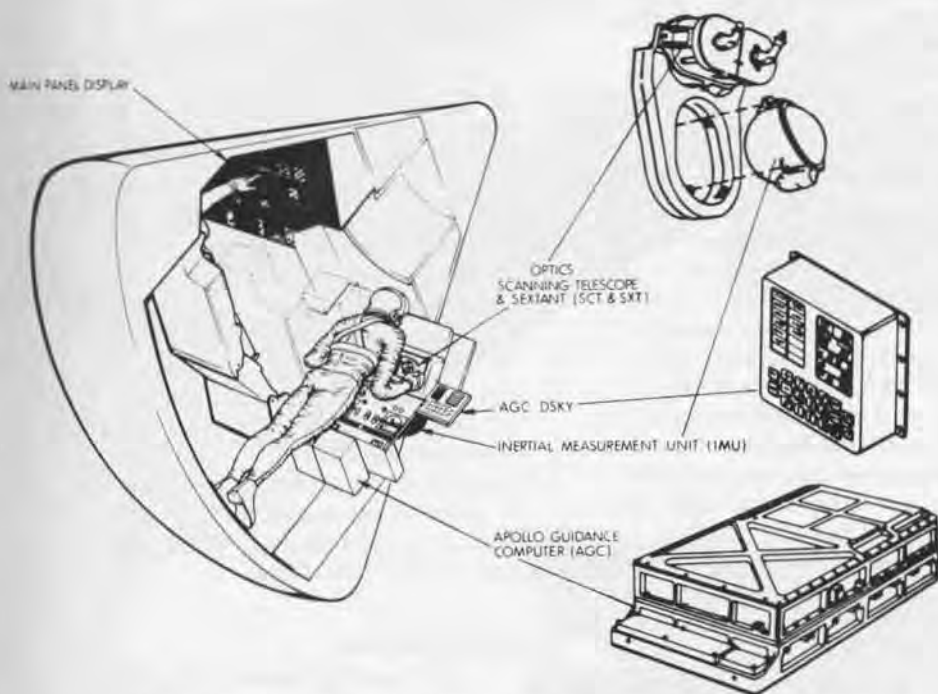

M.I.T. CHARLES STARK DRAPER LABORATORY • Cambridge, Massachusetts • 22930-1 • 9/70

The boost phase of the mission, which was the Saturn system, had its own internal guidance system to put the command and service module in translunar trajectory. Then the Apollo system took over to guide the mission to the moon.

In effect, navigating in space is the same as navigating on Earth. One might take a star sighting with a sextant. That information is put into the computer and from it the state vector, i.e. the position and velocity of the missile at any point of time, is computed. The computer orients the missile such that the change in velocity will cause the state vector to be updated so the missile will free-fall into the targeted point. While it is thrusting, the guidance system must control the attitude of the vehicle, the magnitude of the thrust in the case of the Lunar Excursion Module (LEM), and the direction of the thrust in the case of the Command and Service module.

Design Constraints

Initially, the need for a very reliable computer with significant computational capacity and speed

was clear. The design constraints included very limited size, weight, and power consumption. If the designers had known then what they learned later, or had a complete set of specifications been available as might be expected in today's environment, they would probably have concluded that there was no solution with the technology of the early sixties.

Establishing interface requirements was a monumental task. The astronaut interface was one of these. In 1962, computers were not considered user friendly. Heated debates arose over the nature of the computer displays. One faction, which usually included the astronauts, argued that meters and dials were necessary. Logically, the pressure for digital displays won most of the arguments because of their greater flexibility in the limited area allowed for a control panel. In late 1963, as the requirements for the LEM were being firmed up, NASA decided to use identical guidance computers in both the command module and the LEM.

In the early manned orbital missions before Apollo, NASA

Major units of the CM Guidance, Navigation and Control System.

learned that the human animal, confined in a spacecraft for a week or so, was not as clean as might be expected from observations on Earth. This additional constraint had a rather interesting and far-reaching impact on the mechanical design of the computers and other hardware. All electrical connections and metallic surfaces had to be corrosive resistant and even though the computer was designed to have pluggable modules, everything had to be hermetically sealed.

The Suppliers

By the end of 1962, NASA selected three contractors: General Motors' AC Sparkplug Division for the inertial systems and system integration; Raytheon, Sudbury Division, for the computer and computer testing equipment; Kollsman Instrument for the optical systems; North American Aviation for the command and service module; and Grumman Aircraft for the Lunar Excursion Module.

In late 1959 and 1960 the lab began evaluating semiconductors, purchased at \$1,000 each from Texas Instruments. Reliability, power consumption, noise generation, and noise susceptibility were the prime subjects of concern in the use of integrated circuits in the AGC. The performance of these units under evaluation was sufficient to justify their exclusive use in place of the core transistor logic proposed initially for the Apollo project design. The micrologic version of the Apollo computer was constructed and tested in mid 1962 to discover the problems that the circuits might exhibit when used in large numbers. Finally, in 1964 Philco-Ford was chosen to supply the integrated circuits used in the proto-

type computer that operated in February 1965. These cost approximately \$25 each.

Specifications

Approximately one cubic foot had been allocated in the command module for the computer. The first prototype was operating in the spring of 1964 and utilized the wire wrap and modular welded cordwood construction which had been produced for the Polaris program. It was designed to have pluggable trays with room for spare trays.

Since the clock in the computer was the prime source of time, it had to be accurate to within a few parts per million. The data and instruction words in the memory were 15 bits plus parity. Data was represented as 14-bit binary words plus the sign bit. Double precision operations were provided to supply 28-bit computations. The instruction word contained the address and operation codes for the computer operation. The memory address field was extended by organizing the memory in banks.

The AGC had 2,000 15-bit words of erasable core memory and started with 12,000 words of read-only memory, called rope memory. It was quickly upgraded to 24,000 words. Then by mid-1964, when

the first mission program requirements had been conceived and documented, there was increasing concern about the possible insufficiency of the memory. This prompted a further expansion to 36,000 words.

Design and Use of the Console

A display and keyboard was developed for the astronauts and had the designation DSKY (pronounced "Diskey"). Functionally, the DSKY was an integral part of the computer, and two were mounted remotely and operated through the discrete interface circuits. One was for a sitting position and another one near the entry to the LEM, convenient for a reclining position.

The principle part of the DSKY display was a set of three numeric light registers. Each register contained 5 decimal digits consisting of segmented electroluminescent lights. Five decimal digits were used so that a computer word of 15 bits could be displayed in either decimal or octal. In addition, three two-digit numeric displays indicated the major program in progress, the verb code and the noun code. The verb/noun format permitted communication in a language whose syntax was similar to that of spoken language. Examples of

verbs were display, monitor, load, and proceed. Examples of nouns were time, gimbal angles, error indications, and star identifications. Commands and requests were made in a form of sentences, each with a noun and a verb, such as display velocity or load desired angle. To command the computer the operator pressed the Verb key followed by a two digit code. This entered the desired verb into the computer. The operator then pressed the Noun key and a corresponding code. When the enter key was pressed, the computer carried out the operation that had been commanded. The computer requested action from the operator by displaying a verb and noun in flashing lights so as to attract the astronauts' attention.

In-flight Use

Shortly after liftoff of Apollo 12, two lightning bolts struck the spacecraft. The current passed through the command module and induced temporary power failure in the fuel cells supplying power to the AGC. During the incident the voltage fail circuits in the computer detected a series of power trenches and triggered several restarts. The computer withstood these without interruption of the mission programs or loss of data.

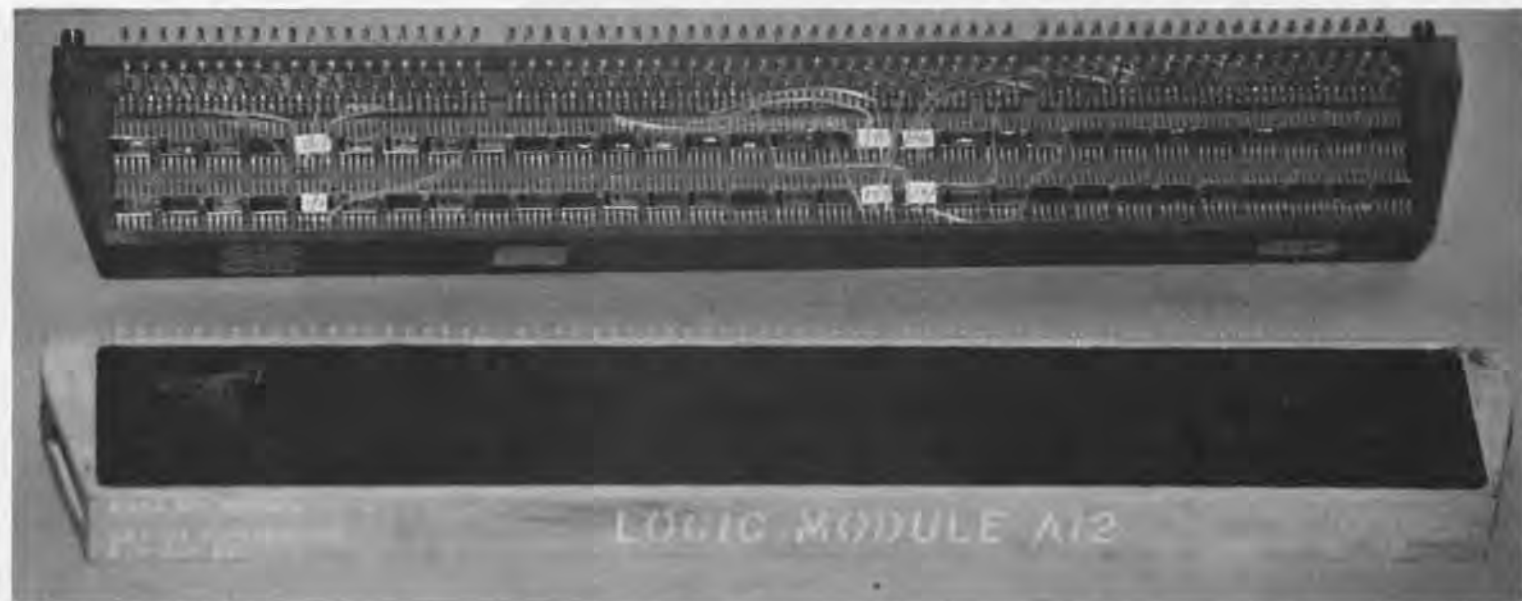

The module in the background is exactly the same as one in the foreground, but it has only been used on Earth. The Museum's prototype computer ran at Draper Labs and was used to test the routines for the in-flight machines. In space all of the components had to be totally "potted" to insure that all the parts would stay firmly in place and remain uncontaminated during space flight.



AGC

DSKY

The Apollo Guidance Computer, shown on the left, was responsible for the guidance, navigation, and control computations in the Apollo space program. The AGC was the first computer to use an integrated circuit logic and occupied less than 1 cubic foot of the spacecraft. It stored data in 15 bit words plus a parity bit and had a memory cycle time of 11.7 microseconds, utilizing 2,000 words of erasable core memory and 36,000 words of read-only memory. The frame is made of magnesium for lightness and designed to hermetically seal the components.

The interface with the astronauts was the DSKY, shown on the right. It used digital displays and communicated with the astronauts using the verb and noun buttons visible in the photograph and two digit operation and operand codes. A set of status and caution lights is shown in the top left corner of the DSKY.

The AGC and DSKY are on display in the Four Generation Gallery.

The AGC rope memory

The read-only memory of the computer consisted of six rope memory modules, each containing 6,000 words of memory. This special type of core memory depended on the patterns set at the time of manufacture. Its sensing wires were woven into a set pattern information. It had five times the density and was far more reliable than the coincident current core memory used for erasable storage in the computer. Being unalterable, it also provided a greater incentive for error-free software development.

The AGC rope memory is on display in the primary memory case.

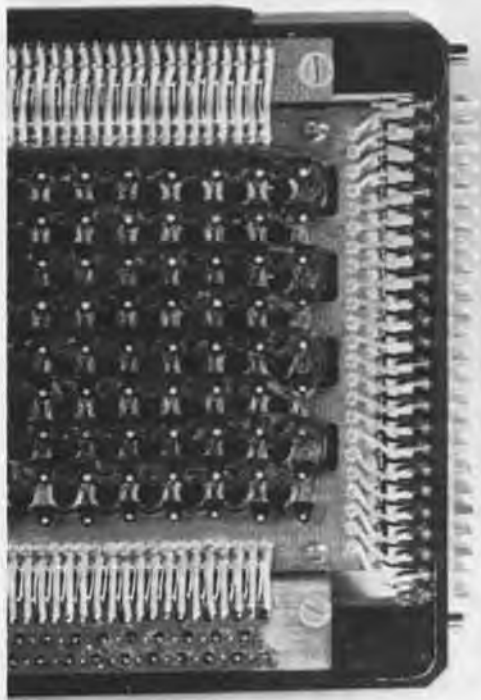

The Apollo 11 lunar landing had an anomaly which attracted public attention. The computer in the LEM signalled a restart alarm condition several times during a very critical period prior to touchdown. This fact was broadcast to the public and those who knew its significance were close to a state of panic. After analysis, it was determined that the alarms were an indication to the astronauts that the computer was overloaded and was eliminating low priority tasks from the waitlist.

The overload resulted from the rendezvous radar being set in the

wrong mode during the lunar landing phase, wasting computer memory cycles. The computer software was responding to overloads as designed.

This incident triggered a news brief in *Datamation* in October, 1969, faulting the computer design for being too slow. It rightfully claimed that there were a number of mini-computers, including the PDP-11, that were at least an order of magnitude faster. In the eight years since the initiation of the Apollo program commercial technology had far surpassed that of the Apollo design and

capacity. However, no commercial computer could claim to match the power consumption and space characteristics of the AGC.

Excerpted from an Illustrated Lecture, June 10, 1982, by Ben Goldberg. The video-tape is archived by The Computer Museum.

The Apollo Guidance Computer

A Users View

David Scott *Astronaut for the Gemini 8, Apollo 9, and Apollo 15 missions.*

In 1963 when NASA was conducting the selection of the third group of astronauts for the U.S. space program, I had just received a graduate degree at MIT and finished test pilots school. My interests and the program's need for a user to interact with the design of the guidance computer at the MIT Instrumentation Lab was a good fit. I was part of those discussions whether to use analog or digital controls that Eldon described.

The MIT Interface

When I was studying at MIT, the ability to rendezvous in space was an issue for debate. It wasn't clear whether it was possible to develop the mathematics and speed of computation necessary to bring two vehicles together at a precise point in space and time—a critical issue for the Apollo missions successful landing on the moon and

return to Earth. Between 1963 and 1969, with the flight of Apollo 9 this was accomplished. I stayed in the spacecraft while Rusty Schweickart and Jim McDivitt got in the lunar module and went out about 60 miles away. The computer behaved flawlessly during our first successful rendezvous in space.

Another assignment for Apollo 9 was to take the first infra-red photographs of the Earth from space. To do this, a large rack of four cameras was mounted on the spacecraft. Since they were fixed to the spacecraft, the vehicle itself had to track a perfect orbit such that the cameras were precisely vertical with respect to the surface that they were photographing. During simulations it was determined that manual orbit procedures would be inaccurate. We were at a loss. About two weeks before the flight

I called up MIT and asked if they could program the computer to give the vehicle a satisfactory orbit rate. They answered, "Of course, which way do you want to go and how fast?". In a matter of a couple of days we had a program and a simulator that automatically drove a spacecraft at perfect orbit rate. We got into flight with very little chance to practice or verify, but we put on the cameras and the results were perfect.

Potential Computer Failure

During the development process we ran many simulations of in-flight computer operations with particular concern for in-flight failure. But in the 10 years that I spent in the program there was never a real computer failure. Yet, people often wonder what a computer failure would have meant on a mis-



sion. It would have depended on the situation and the manner in which the computer failed. We probably would not have expired, but there were some parts of the mission in which a computer failure would have been especially compromising. Navigation was not necessarily time critical but the lunar landing was very time critical. You could have a situation during a lunar landing in which, if the computer failed, the engine would be driven into the ground. Unless the astronaut could react quickly enough to stop it, the Lunar Module could have been flung on its side. Chances are that the astronaut could prevent such an event by switching to manual control of the vehicle. It must be remembered that the computer had been designed to be as reliable as possible and the astronauts had a great amount of confidence in the machine.

And Problems of Success

We had a backup called the entry monitor system, which had a graphic display based on the accelerometers in the spacecraft. With this display the vehicle could be flown manually using pre-drawn curves to be followed for attitude, g-loading, and velocity. It was reassuring to know that we were still able to return to Earth even if the Apollo Guidance Computer failed. During reentry there was a scroll in the entry monitor system and we could see the computer tracking the predetermined curves all the way to the landing site. As our skills and the computer programs improved over the years of the Apollo program, we came down closer and closer to the carrier. Finally, by the last Apollo mission they didn't park the carrier on the landing point.

Excerpted by Ben Goldberg from remarks after Eldon Hall's Lecture, June 10, 1982.

The Apollo 9 Crew, (from left) Dave Scott, Command Module Pilot; Jim McDivitt, Commander; Rusty Schweickart, Lunar Module Pilot. Apollo 9 was launched on March 3, 1969. The first separation and rendezvous of the Lunar and Command Modules was carried out in Earth Orbit on this flight.

Dr. Charles S. Draper, Chief Scientist, C.S. Draper Laboratory with astronaut David Scott, at the opening celebration of the Museum, June 10, 1982.



"Before the missile and Apollo guidance programs, the problem of airplanes attacking ships at sea was a difficult one, so I began to do the ballistics analysis myself, plotting on a sheet with a pencil and a slide rule. This analysis worked well enough so that ships were able to defend themselves against air attacks. When the time came to develop the Polaris and Apollo programs, our attitude was much the same: we couldn't afford any failures, so we didn't have any."

Dr. Draper at the lecture on the design of the Apollo Guidance Computer.

Whirlwind Before Core

Reminiscences of Jack Gilmore

In October, 1950, I joined the Whirlwind team. At that time the first thirty-two registers of toggle switch memory were working. The four variable flip-flop registers could be assigned to any one of the thirty-two addresses. They were able to demonstrate small mathematical programs such as the bouncing ball problem or solve simple differential equations. The first memory consisted of electrostatic storage tubes totaling 256 locations. We felt really rich with a full 256 variable registers to write our programs. We calculated the operation in the octal address and then looked up what was then called the sexidecimal conversion number (later the term hexadecimal was used). We had a little load program in the 32 registers and that bootstrapped the programs up into the memory in order to run them.

The first thing that we were very anxious to do was to get an assembly program that would allow us to be able to write our programs using mnemonic symbols and expressing the numbers in dec-

imal and octal. My boss, Charlie Adams, was concerning himself with that and so it became my job to write the assembly program. I'm fairly certain that if it is not the first, it is one of the very first assembly programs ever written. The only one that I know of that predates it was Wilkes' 'Load and Go' on the EDSAC.

In September, 1951, John Carr, later Chairman of Duke's Computer Science Department, and I wrote a document that explained how people could actually use subroutines in conjunction with assembly programs, so that they didn't have to write all the various utilities. People could write their programs in a relative fashion and then we would give them the library of subroutines and they'd actually pick out the tapes that they needed. We'd then string the tapes together and literally make a copy not only of their program but also of the subroutines. All of those would be pulled in through the bootstrap program and it would run. This was the indirect birth of the symbolic address. The thing that we discovered, I think I actually discovered it, was that when we ran the tape through twice, you could

refer to an address above where you were, as opposed to everything going below. The two pass assembler came out of all that. I have a recollection of Charlie Adams and I briefing IBM's Nat Rochester on how to produce symbolic addresses.

The Ph.D. candidates who needed to use the Whirlwind really didn't know how to run the machine. There were full scale electronic technicians who knew how to bring it up, and most of the systems programmers like myself knew how to do it, as well as some of the engineers. It was a fairly routine procedure so I went to Charlie Adams and suggested that I could train two people right out of high school to be computer operators if I had enough funds to hire them for one year. Jay Forrester provided the funds and I went out to two local high schools and asked for students that were college material but didn't have the money for college. I hired Joe Thompson from Boston Technical High School (shown sitting down in the photograph) and Bill Kyle from Boston English. Within four or five months they were competent operators, and Joe stayed on to complete his

This 1951 photograph of Whirlwind shows Joe Thompson seated at the Flexowriter typewriting unit. Jack Gilmore is standing in front of the 256 x 256 point display used for alphanumeric and graphic representations of various computations. The display was utilized to plot solutions of partial differential equations for determining the optimal rate of pumping oil from underground caverns and also for displaying the optimal placement of television antennas for compliance with F.C.C. regulations.



degree at Lowell Tech in the evenings. One day Forrester came in and sat at the back of the room. He watched for about an hour while Bill and Joe completed eight or nine different jobs. Finally Jay said, "We've just created a new vocation." He also recognized this as the solution to the problem of computer operators for the SAGE project.

The flexowriter typewriting unit we used was a word processing system, originally designed for list processing and promotional mailings. It had a mechanical reader and would create a form letter in a loop with stop codes to key in the personal information. We used it as an integrated word processing system, circa 1951.

One Sunday afternoon in December 1951 the Whirlwind was featured on 'See It Now', Edward R. Murrow's program. Ron Meyer and I stayed up all weekend writing a program to display the trajectory of a Viking rocket on the display and another program that played Jingle Bells. They wired Jay Forrester with a mike and had the wire coming up his back with cables on the floor so he could walk from one part of the console to another. As he started to walk the wire snagged and the back of his coat started to come up. One of the CBS technicians decided that he was going to undo the snag and started to crawl across the floor like a commando. Forrester, not realizing that his coattails were at 90 degrees, couldn't understand why the technician was crawling towards him. We decided that Forrester was getting too distracted and so the technician was pulled back across the floor by his ankles. Meanwhile, Edward R. Murrow and Jay Forrester completed the interview which ended with Jingle Bells being played for the pre-Christmas viewers.

[The museum has archived a copy of the video tape of the Murrow interview in which Jack Gilmore may be seen loading the tape reader]

Extracted by Ben Goldberg from a Gallery Talk by Jack Gilmore, June 16, 1982.

Profile of a Board Member

Les Hogan's involvement in electronics began while he was in the Navy during World War II. His work with the acoustic torpedo led him to obtain a doctorate in physics at Lehigh following the war. In 1950, three months after he joined Bell Labs, he invented the microwave gyrator. In 1953, he was invited by John VanVleck to become a Professor at Harvard University.

Hogan's influence on the development of the semi-conductor began in December 1957, when he became executive vice-president of Motorola and general manager of the semi-conductor division. He later became President and Chief

Executive Officer of Fairchild Camera and Instrument. At present, Dr. Hogan spends about half his time as Technical Advisor to the President of Fairchild, is an active board member of six corporations, and is advisor to Stanford, Berkeley, and MIT's engineering schools.

Dr. Hogan is deeply interested in the development of The Computer Museum because, in his words, "I have spent my entire career in high technology electronics including the last twenty-five years working on the semi-conductor. Computer technology has been my life."

Reported by Allison Stelling.



"All of the memorabilia in junk piles across the country needs to be collected so that people can see what the early days of computing looked like. With such fast-changing technology, a computer museum is as much for the people who are part of the industry as it is for the next generation."

C. Lester Hogan

Opening Celebration: June 10th 1982

The Board of Directors and the Chairman of the Members' Association switched on the breadboard of the Atanasoff-Berry Computer, ceremonially "turning on" the Museum. George Michael and Gwen Bell wait to flip a switch on the Atanasoff-Berry breadboard. Kitty Selfridge is at the control panel, while Michael Spock, Lester Hogan, Gordon Bell and Brian Randell watch.



At the Opening and first board meeting, many of the Board members had their first tour of the Museum. The old hands, such as Gordon Bell, each had their assignment to explain and guide a new board member through the exhibitions. Gordon is giving Senator Paul Tsongas and his aide Andy Bagley an overview using the self-guiding brochure now available.



ARCHIVES AND LIBRARY

This fall, Gregor Trinkaus-Randall will join the staff as archivist and librarian. Gregor will work to establish an archives and library for scholarly use.

An Archives Advisory Committee met for the first time on June 9 and will meet again in May of 1983. Committee members will assist Gregor in the development of a comprehensive computing history archives. Those interested in participating should contact Gregor Trinkaus-Randall at the Museum.

The Library and Archives will be located on the lobby floor of the Museum and should be open in the spring of 1983. The collection will include documents relevant to exhibited artifacts. With only a small budget for acquisitions, the Library and Archives will be dependent upon donations of deaccessioned materials from company and private libraries.

Beth Parkhurst showing Uta Merzbach, Curator of Mathematics at the Smithsonian, the Four Generation Gallery.

INTERN PROGRAM

This summer, eight interns worked at the Museum on various special projects. Students are invited to apply for paid internships at the Museum for any period up to six months. The number of students will vary according to the number of activities going on at any time. Internships will complement the various operational sections of the Museum. The listing of this summer's interns and their activities indicates the wide range of possibilities.

Beth Parkhurst started as an intern in the summer of 1981. She is now a Research Assistant at the Museum, spending one day a week during the school year while she works to complete her Ph.D. in the American Civilization program at Brown University.

Andy Kristoffy, a junior in Computer Science at the University of

Apollo Guidance Computer in this issue and will work on a comprehensive exhibit of the Polaris and Apollo Guidance Computers.

David Bromfield, a Senior at MIT in Business Management, is the Acting Business Manager. As such, he has set up the initial accounting systems for the Museum.

Roberto Canepa, a junior in electrical engineering at Carnegie Mellon University, has been rebuilding the number sieves built by Professor Derek Lehmer of Berkeley. His two biggest challenges are the recreation of a bicycle chain machine from photographs taken in the 1920s and the restoration of the gear machine exhibited at the 1932 Chicago World's Fair.

Allison Stelling, a junior at Harvard majoring in History and Computer Science, has concentrated on doing research to gather photographs for our collection.



Massachusetts, will spend next year at the University of Manchester. Andy also started in 1981 and this summer has assisted Jamie Parker in the organization and installation of the Four Computer Generations exhibition. *

Ben Goldberg recently completed his B.A. at Williams and is entering the Ph.D. program in Computer Science at Yale University. Ben prepared the story of the

Farrell Woods, a sophomore at the University of Massachusetts, has organized the Museum's artifact storeroom. He is drafting a proposal for the development of a build-your-own tinker-toy computer.

Gayle Morrison, who will enter Becker Jr. College in the fall, plans to major in Word Processing Administration. She has assisted Sue Hunt, the Museum's main secretary, with all the extra activities.

SUMMER GALLERY TALKS

The summer gallery talks provided informal seminars on computer history for visitors, summer interns, and staff. As part of our archival efforts, each intern was given the responsibility for audio taping and transcribing one talk, and, if appropriate prepare it as an article for the *Report*.

These talks provided a focus for the week and will be repeated next summer—perhaps with even greater frequency. We have all found that many of the Museum's members and visitors have a great deal to add to our knowledge and so we invite self-nominations for giving a gallery talk.

June 16. Jack Gilmore's talk on his days as a programmer and operator of the Whirlwind is covered in this issue of the *Report*.

June 23. Gwen Bell outlined the museum's taxonomy for classifying calculating devices and computers.

June 30. Alan Kotok, one of the author's of Space War on the PDP-1 at MIT, demonstrated the program, and described the original environment of the machine.

July 7. Maurice Wilkes walked along the Pioneer Computer Timeline reminiscing about the people and events portrayed on it.

July 14. Paul Ceruzzi, one of the first Charles Babbage Institute fellows and professor of Computing History at Clemson University, spoke on the evolution of the "computer age".

July 21. TX-0's only technician, John McKenzie, pointed out the features of the machine and noted highlights from its era at MIT.

July 28. Bob Glorioso spoke about his experiences with vacuum tubes, transistors, and integrated circuits, many of which he collected and has donated to the museum.

August 4. "The Thinking Machine" a 1960 television special featuring early work at MIT in Artificial Intelligence and the TX-0 was shown.

August 11. As part of the development of the exhibit of the sieve machines built by Derek Lehmer, Dick Rubin-

stein spoke about their principles and evolution.

August 18. The early development of integrated circuits at Texas Instruments was described by Jeff Kalb.

August 25. "Atavistic Beginnings of Personal Computers" was the final session given by Geoff Feldman and Rick Jevon, who worked at The Computer Store, the first retail outlet for personal computers.

FOUNDERS

Until June 1984, the opportunity exists for corporations and individuals to become Founders of the Museum. This provides a unique, opportunity to initialize a new major institution. The original set of 11 Corporate Founders and 51 Individual Founders were listed in the first *Report*.

New Corporate Founders:

Benton and Bowles
Intel Corporation
Richard Reno

New Individual Founders:

Charles W. Adams
Michael and Merry Andelman
Isaac O. Auerbach
Leo L. Beranek
Eric Bloch
George A. Chamberlain III
Harvey Cragon
Edson de Castro
Harvey and Barbara Deitel
Georgedna Doriot
Jay W. Forrester
Alan Frisbie
Samuel H. Fuller
Margaret A. Herrick
Peter S. Hirshberg
L. R. Jasper
R. L. Lane
Harold W. Lawson, Jr.

John V. Levy
Julius L. Marcus
Thomas and Elizabeth McWilliams
Richard G. Mills
Martin O'Donnell
J. Porter
Brian Randell
Ronald G. Smart
John Stark
Max J. Steinmann
Robert E. and Diane M. Stewart
Norman H. and Robert W. Taylor
William R. Thompson
Fritz and Nomi Trapnell
An Wang
Thomas E. Welmers
William Wolfson



The Computer Historian's Bookshelf

The Museum's bibliophiles have agreed on a list of books that they would have in their own libraries. To make it easy for you to have this collection, all the books have been stocked in the Museum store and can be ordered using the form at the back of this Report.

We began by considering all the books in Bill Aspray's and Brian Randell's bibliographies and ordered the ones in print. Then, we started our own review process, both adding and eliminating books. After reading several reviews and the books, we agreed on a short extract to use in characterizing the book.

The final step was to classify the books. Four categories resulted: History; Pre-history; Recreational Reading; and Reference.

We'll keep track of the "best sellers" and incorporate your recommendations and evaluations into future book lists.

Gwen Bell
Ben Goldberg
Beth Parkhurst
Dick Rubinstein
Allison Stelling

HISTORY

Annals of the History of Computing, Vol. 3, No. 4, October 1981, illustrations and diagrams.

Order: ANN81 \$8.00

This classic issue of the *Annals* is devoted to an insider's view of the first general-purpose electronic computer. The ENIAC monograph by Arthur W. Burks and Alice R. Burks presents a well-reasoned view of ENIAC's place among computer developments of the day, and gives a long-needed description of the machine's design logic, circuitry, and problem set-up. Comments by J. G. Brainerd, J. P. Eckert, K. R. Mauchly, B. Randell, and K. Zuse follow.
Beth Parkhurst

A History of Manchester Computers, by Simon Lavington, 1975, National Computing Centre, Manchester, England, fully illustrated, 44 pages.

Order: LAV75 \$6.50

"This very useful booklet summarizes the history of five successive computer projects at Manchester University, during the period 1946-1975. The early pages give information, from primary sources, on the development of the first computer at Manchester, and on the roles of F. C. Williams, T. Kilburn, M. H. A. Newman, A. Turing, and others. Profusely illustrated." Brian Randell

An Age of Innovation: The World of Electronics, 1930-2000, by the editors of *Electronics*, 1981, McGraw-Hill, New York, fully illustrated.

Order: ELE81 \$18.50

"A coffee-table book for everyone interested in electronics . . . the history is accurate and interesting, perhaps more interesting for the nostalgia it stimulates. . . . Much less satisfactory are the last sections, which attempt a view of the future of electronics." Eric A. Weiss in the *Annals of the History of Computing*

History of Binary Numbers and Other Non-Decimal Numeration, by Anton Glaser, 1981, Tomash Publishers, 218 pages.

Order: GLA81 \$28.00

" . . . a carefully revised version of the author's Ph.D. thesis. . . . The coverage is extensive and very well written . . . makes a significant contribution to our understanding of the complex world in which we live." *Annals of the History of Computing*

25 anniversary issue, *IBM Journal of Research and Development*, Vol. 25, No. 5, September 1981, 846 pages.

Order: IBM81 \$6.00

A very rich volume chronicling the technical achievements of IBM in six areas: System Architecture and Development; Software Technology; Component Development and Manufacturing Technology; Magnetic Recording Technology; Printing Technology; and IBM Scientific Contributions.

Computers: From Pascal to Von Neumann, by Herman H. Goldstine, 1972, Princeton University Press, Princeton, New Jersey, 378 pages with 14 illustrations, paperback.

Order: GOL72 \$6.95

"An interesting work dealing briefly with the development of the computer from the 17th Century to the 1930's, and extensively with the work of the author, John von Neumann and others. . . . Their creation of the first electronic digital computer, ENIAC, during World War II, and postwar developments at the Institute as part of the burgeoning world-wide 'computer revolution' make up the major portion of this fascinating view of the computer world." C. R. LeSueur, *Library Journal*

Antique Scientific Instruments, by Gerard L'E. Turner, 1980, Blanford Press Ltd., Poole, Dorset, 69 color plates, 168 pages.

Order: TUR80 \$20.00

The author, Senior Assistant Curator of the Museum of the History of Science, Oxford University, has collected his illustrations and materials from a variety of European museums and collections. The first four chapters on astronomy and time-telling, navigational instruments, surveying instruments, and drawing and calculating instruments are particularly relevant to the pre-history of computers. The last chapter, "Practical Advice on Collecting," will be especially useful to collectors. Gwen Bell

Computer Engineering, A DEC View of Hardware Systems Design, by C. Gordon Bell, J. Craig Mudge, and John E. McNamara, 1978, Digital Press, 561 pages.

Order: BEL78 \$28.00

"This book attempts to cover the entire Digital Equipment Corporation product line starting with the early module series and the PDP-1, including such popular computers as the PDP-8, PDP-10, and PDP-11. . . . For everyone interested in how and why computers and digital systems are designed and implemented, whether student or experienced practitioner, this book is a must."

L. A. Hollaar, *ACM Computing Reviews*

A History of Computing in the Twentieth Century, edited by N. Metropolis, J. Howlett and Gian-Carlo Rota, 1976, Academic Press, Inc., New York, 659 pages with 121 illustrations and photos and 4 tables.

Order: MET76 \$29.50

"If you've been thinking that some day you should read something on computer history, buy this book! It consists of edited versions of papers presented in 1976 at an invitational conference supported by the Los Alamos Scientific Laboratory (and held there) and by the National Science Foundation. The authors of the 37 papers include a high percentage of the people who personally did the pioneering work in computing or were first-hand witnesses to it." D. D. McCracken, *Computing Reviews*

The Origins of Digital Computers: Selected Papers, edited by Brian Randell, 1975, Berlin, Springer, bibliography.

Order: RAN75 \$35.00

"An outstanding collection of excerpts from important nineteenth and twentieth century computer developments, together with background and commentary on each excerpt." William Aspray

Project Whirlwind: The History of a Pioneer Computer, by Kent C. Redmond and Thomas M. Smith, 1980, Digital Press, Bedford, Massachusetts, 67 illustrations and diagrams, 280 pages.

Order: RED80 \$25.00

"This book is not a technical engineering account. Instead, it is an attempt to reconstruct the complexity of technical, financial, and administrative problems and the eventual compromises and solutions to these problems." Henry S. Tropp in the *Annals of the History of Computing*

From ENIAC to UNIVAC: An Appraisal of the Eckert-Mauchly Computers, by Nancy Stern, 1981, Digital Press, Bedford, Massachusetts, 38 illustrations and diagrams, appendix, 286 pages.

Order: STE81 \$25.00

"This volume is derived from Nancy Stern's Ph.D. thesis. . . . The emphasis is on people and environment. . . . The volume is handsome and is enhanced by a large number of illustrations and diagrams." Henry S. Tropp in the *Annals of the History of Computing*

Early British Computers: The Story of Vintage Computers and the People Who Built Them, by Simon Lavington, 1980, Digital Press, Bedford, Massachusetts, fully illustrated, appendix, 139 pages.

Order: LAV80 \$9.00

"This volume, sprinkled with more than 60 photographs, discusses wartime work on Colossus, EDSAC, Pilot ACE, the Manchester Mark I, LEO, and other early British computers." Henry S. Tropp in the *Annals of the History of Computing*

The Computer and the Brain, by John Von Neumann, 1958, Yale University Press, New Haven, 82 pp.

Order: VON58 \$3.45

"This book, composed of material prepared for the Silliman Lectures by John Von Neumann before his death, represents the views of one of the greatest mathematicians of the twentieth century on the analogies between computing machines and the living human brain." *Library Journal*

History of Programming Languages, by Richard L. Wexelblat, ed., 1981, Academic Press, New York, 748 pp.

Order: WEX81 \$45.00

"... a very valuable and readable source of historical information on the development of the most important and influential programming languages. . . . this is a book that should appeal not just to people with a serious interest in the history of computing but to anybody who has experienced the delights and frustrations of computer programming. . . ." Brian Randell in *Science Magazine*



PRE-HISTORY

Origins of Modern Calculating Machines, by J. A. V. Turck, 1972, Arno Press Inc., New York, 196 pages with 38 illustrations.

Order: TUR72 \$17.00

This book is a chronicle of the evolution of mechanical calculating and recording machines including machines such as Pascal's machine, the Comptometer, the Burrough's machine and the Billing's machine. Written in 1921, the book is of historical interest for its unique perspective, its extreme detail and excellent illustrations." Allison Stelling

Collecting Mechanical Antiques, by Ronald Pearsall, Arco Publishing Company Inc., New York 1973, 92 illustrations, 197 pages.

Order: PEA73 \$7.95

This book provides an illustrated history of the sewing machine, typewriter, telegraph, telephone, camera, cinematograph, automata and mechanical toys, mechanical music, domestic appliances and gadgets. Gwen Bell

The Clockwork Universe, edited by Klaus Maurice and Otto Mayr, Smithsonian Institution, Washington, D.C., Meale Watson Academic Publications, New York, 1980, 200 illustrations and technical drawings, 322 pages.

Order: MAU80 \$35.00

The book is the catalog of the exhibition The Clockwork Universe produced jointly by the National Museum of History and Technology, Smithsonian Institution and the Bayerisches Nationalmuseum, Munich. In fourteen contributions from European and American scholars, the book depicts the golden age of German clockmaking, 1550-1650 with detailed physical descriptions of the finest clocks, automata and mechanical celestial globes surviving from the time. Gwen Bell

A History of the Machine, by Sigvard Strandh, 1979, A&W Publishers, Inc., New York, fully illustrated with diagrams, 234 pages.

Order: STR79 \$35.00

The author, Director of the National Museum of Science and Technology in Stockholm, has put together an explanatory illustrated text that is second best to going to a good science museum. Chapter 8, Computers, has excellent diagrams ranging from the workings of the Jacquard loom to the inside of the HP-35. Other chapters cover early machines, tools and robots, windmills, engines, electricity, control systems, and household tools. Gwen Bell

Early Scientific Instruments, by Nigel Hawkes, 1981, Abbeville Press, Inc., New York, 73 full page color illustrations, 164 pages.

Order: HAW81 \$30.00

"In this book are illustrated important examples from the diverse range of artifacts with which man has tried to discover and explain the complexities of the physical world, and, through this comprehension, use nature for his own ends. These early instruments, in addition to providing a tangible record of the development of scientific knowledge, vividly demonstrate the technical ingenuity of former times."

D. J. Bryden in the Introduction

RECREATIONAL READING

Micromillennium, by Christopher Evans, 1979, The Viking Press, New York, 255 pages.

Order: EVA79 \$10.95

"[This is an] enthusiastic and optimistic review of the past, present, and, especially, future [of computers]. . . Informative, fast-paced, and well-organized, the book is eminently readable. . . ." B. C. Hackler, *Library Journal*

The Computer Establishment, by Katharine Davis Fishman, 1981, Harper and Row, New York, 468 pages.

Order: FIS81 \$20.95

"Mrs. Fishman has written a splendid study of the computer revolution. This is not the book from which to learn the details of computer technology (although such technical material as it contains is presented with great economy and clarity), but it is definitely a book from which to learn about the computer industry." *The New Yorker*

Discovering Computers, by Mark Frank, 1981, Stonehenge Press Inc., London, 96 pages with 104 illustrations and photographs.

Order: FRA81 \$9.95

This book from an excellent series for young people does justice as a child's introduction to computers. Appropriate for junior high level. Frank's book was written expressly for readers with no previous knowledge about computers, math, or science. It describes how computers function and what computers can and cannot do. Chris Rudomin

The Enigma War, by Jozef Garlinski, 1980, Scribner, New York, 211 pp.

Order: GAR80 \$14.95

"Historians of WW II and specialists in intelligence cryptanalysis will find Garlinski's study indispensable; it is the most detailed, corroborated account of the development and perfection of the "Enigma" machine by which the Allies were able to decipher a great portion of the strategically important Nazi and Japanese radio messages from 1940 onward." *Choice Magazine*

The Soul of a New Machine, by Tracy Kidder, 1981, Little, Brown and Company, Boston, 293 pages.

Order: KID81 \$13.95

"Kidder . . . provides a feeling for what this new and ever-changing technology is all about. He tells a human story of enormous effort; yet, eerily, it is the Eagle itself that emerges as the book's hero." *Saturday Review*

Museum
store

Microelectronics Revolution, by Tom Forester (ed.), 1980, M.I.T. Press, Cambridge, Massachusetts, 589 pages with 104 photographs and illustrations, paperback.

Order: FOR80 \$12.50

"Editor Forester, a journalist, presents 41 pieces written from the mid- to the late-1970's on a technology that could revolutionize our lifestyles and work habits while displacing major segments of the labor force in a sort of second Industrial Revolution. Several chapters outline the technical side of microelectronics, but all are within the layperson's grasp, and the book concentrates on the social implications of the technology. . . . This is one of the more thorough treatments available on the subject." Barbara Gaye, *Library Journal*

Machines Who Think: A Personal Inquiry into the History and Prospects of Artificial Intelligence, by Pamela McCorduck, 1979, W. H. Freeman and Company, San Francisco, 364 pp.

Order: MCC79 \$8.95

"In this delicious book—witty, informed, open, rich in direct and candid testimony—a novelist reports her visits among the ambitious projectors and her estimates of what they do, say, and plan. She offers a good deal of wise reflection but never one flowchart or formula." P. Morrison, *Computing Reviews*

Hut Six, by Gordon Welchman, McGraw-Hill Book Company, New York, 1982, 326 pages.

Order: WEL82 \$12.95

"A fascinating account of the breaking of the German 'Enigma' code which took place at Bletchley Park in England. The author was deeply involved in the crypt-analysis project, and thus presents a very personal history of the events leading up to the codebreaking. The book offers an excellent insight into the personalities involved in the project. The last section of the book is devoted to an analysis of the current state of the communications systems in the U.S. defense program, a scathing critique." Ben Goldberg

REFERENCE

Electronic Inventions and Discoveries, by G. W. A. Dummer, Pergamon Press, Oxford, 2nd edition, 1978, 204 pages.

Order: DUM78 \$20.00

The meat of the book is a brief description of each electronic invention in date order. The work is fully indexed by subject, invention, and inventor. Interesting descriptions and illustrations make the book fun for browsing as well as useful for reference. Gwen Bell

Data Processing Technology and Economics, by Montgomery Phister, Jr., 1979, Digital Press, Bedford, Massachusetts, 717 pages with 535 illustrations and 261 tables, paperback.

Order: PHI79 \$33.00

"An updated version of this original marvelous tome of copious data-processing-related facts and figures. This would represent the data-processing equivalent of the annual information almanacs—if it were made current more frequently. Unqualifiedly superb as a reference work, it also makes for fascinating browsing." *Choice*

Computer Dictionary, by Charles J. Sippl and Roger J. Sippl, 1982, Howard W. Sams & Co., Inc., Indianapolis, 624 pages with 55 photos and illustrations, paperback.

Order: SIP82 \$15.95

"This is a 'browsing' dictionary. . . . Many definitions and explanations are long and are designed to be so. Users of this book can easily and leisurely browse through the main and supplemental 'areas,' such as 'data base,' to learn significant details about the products, procedures, problems and proliferating applications." *Preface, Computer Dictionary*



DIGITAL COMPUTER MUSEUM



JUNE 10, 1982

The Opening Poster

Order: 61082 \$4.00

Full color, 20 x 30 inch poster commemorating the opening of the Museum. The photograph shows the vacuum-tube power driver of the first core memory bank for Whirlwind, 1953, and a prototype integrated circuit for the Apollo Guidance Computer, 1965.

1983 Calendar: The Computer Era, 9 x 12 folded, spiral bound, heavy coated paper.

Order: YEA83 \$7.95

This calendar is illustrated with photos of contemporary computing systems or components from major manufacturers along with equivalents from the early age of computing. The major historic events that can be pinned down to an exact day, such as Babbage's birthday, the announcement of the IBM 360, or Stibitz's 1940 demonstration of calculating via teletype from Dartmouth to New York are recorded. The calendar is beautiful, informative and fun. Gwen Bell



October 7

D.H. LEHMER

HISTORY OF THE SIEVE MACHINES

The 1936 electro-mechanical sieve shown at left is one of Derek Lehmer's sieve process machines, devices which aided in solving certain equations using principles of number theory. He has donated three complete sieves and plans for his 1926 bicycle-chain machine to the Museum. His lecture will describe the evolution of these machines from 1926 to the mid fifties, and commemorate the opening of their exhibition at the Museum.

October 21

HERBERT J. GROSCH

**THE WATSON SCIENTIFIC LABORATORY
1945-50**

As the first assistant to Wallace Eckert and director of the computing program, Herbert Grosch will provide a narrative of the development of the Columbia Laboratories up to the time of NORC.



November 18

HARRY HUSKEY

FROM PILOT ACE TO G-15

As a Fulbright scholar, Harry Huskey spurred the building of the Pilot ACE at Britain's National Physical Laboratory. Returning to the USA, he was the chief designer of the SWAC and the Bendix G-15. His lecture will provide a chronicle of the evolution from single laboratory to commercial computers.



The Bendix G-15

A newsbrief of the collection

One of the first NOVA central processing units, a recent gift from Data General, is currently exhibited with its original advertising photographs and engineering drawings at the Museum. Introduced in 1968, the NOVA was priced at \$8,000 with mixed and matched RAM and ROM to 32,000 words.

The CPU, located by Kris Eberlin of Data General, is the 203rd unit manufactured by the company. The NOVA can be seen in the Four Computer Generations gallery. The Museum's newest exhibition, the gallery highlights major technological inventions, significant hardware and software, and computer applications.

The
Computer
Museum

One Iron Way
Marlboro
Massachusetts
01752

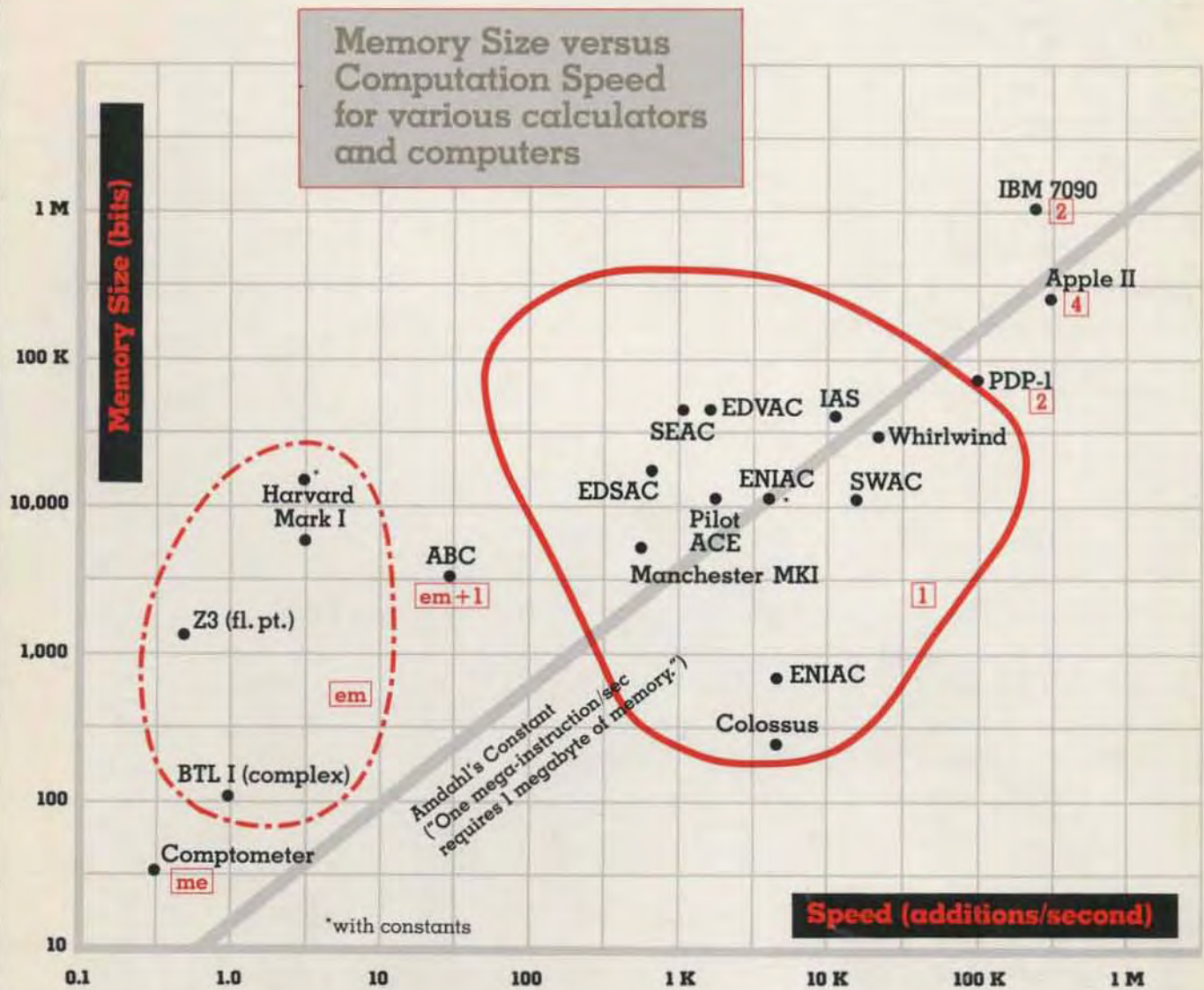

GENERATIONS:

m = manual
me = mechanical
em = electromechanical

1 = electronic—vacuum tube
2 = transistor
3 = integrated circuit
4 = large scale integrated circuit

A COMPANION TO THE PIONEER COMPUTER TIMELINE

CONTENTS

A Companion to the Pioneer Computer Timeline

- 1 Introduction
- 2 Bell Telephone Laboratories Model 1 Complex Calculator
- 3 Zuse Z1, Z3
- 4 ABC, Atanasoff Berry Computer IBM ASCC (Harvard Mark I)
- 5 Colossus
- 6 ENIAC
- 7 EDVAC
- 8 IAS Computer
- 9 EDSAC
- 10 Manchester University Mark I
- 11 Pilot ACE
- 12 National Bureau of Standards SEAC and SWAC
- 13 Whirlwind
- 14 The Pioneer Computer: Comparative Statistics
- 16 Additional Source Material



Photo Credits: p.3, from Konrad Zuse; p. 4, top from John Vincent Atanasoff; p. 5, column 1, Harvard University, Cruff Laboratory; p. 6, from Arthur Burks; p. 7, William M. Rittase; p. 8, Institute for Advanced Studies, Princeton University; p. 12, National Bureau of Standards; pps. 2, 4, 5, 9, 10, back cover, David Bromfield

THE COMPUTER MUSEUM

The Computer Museum is a non-profit, public, charitable foundation dedicated to preserving and exhibiting an industry-wide, broad-based collection of the history of information processing. Computer history is interpreted through exhibits, publications, videotapes, lectures, educational programs, and other programs. The Museum archives both artifacts and documentation and makes the materials available for scholarly use.

The Computer Museum is open to the public Sunday through Friday from 1:00 to 6:00 pm. There is no charge for admission. The Museum's lecture hall and reception facilities are available for rent on a prearranged basis. For information call 617-467-4443.

Museum membership is available to individuals and non-profit organizations for \$25 annually and to businesses for \$125 annually. Members receive the quarterly Report, invitations to all lectures and special programs, new posters, and a ten percent discount in the Museum store.

A Founders program is in effect during the initial two-year period of the Museum, until June 10, 1984. During this period individuals and non-profit organizations may become Founders for \$250 and businesses and charitable Foundations may become Founders for \$2500. Founders receive all benefits of membership and recognition for their important role in establishing the Museum.

THE COMPUTER MUSEUM REPORT

The Computer Museum Report is published quarterly by The Computer Museum, One Iron Way, Marlboro, MA 01752. Annual subscription is part of the membership of the Museum (\$25 per year for individuals and nonprofit organizations and \$125 for corporations).

The purpose is to report on the programs and exhibitions of the Museum. The contents of The Computer Museum Report may not be reproduced without written consent.

The Museum Staff is responsible for the contents of the Report. The opinions expressed do not necessarily represent those of The Computer Museum or its Board of Directors.

The design and production of the Report is done by Benson and Clemons.

BOARD OF DIRECTORS

Kenneth H. Olsen, Chairman
Digital Equipment Corporation

Charles W. Bachman
Cullinane Database Systems

C. Gordon Bell
Digital Equipment Corporation

Gwen Bell
The Computer Museum

Harvey D. Cragon
Texas Instruments

Robert Everett
The Mitre Corporation

C. Lester Hogan
Fairchild Camera and Instrument Corporation

Theodore G. Johnson
Digital Equipment Corporation

Andrew C. Knowles, III
Digital Equipment Corporation

John Lacey
Control Data Corporation

Pat McGovern
ComputerWorld

George Michael
Lawrence Livermore Laboratories

Robert N. Noyce
Intel

Brian Randell
University of Newcastle-upon-Tyne

Edward A. Schwartz
Digital Equipment Corporation

Michael Spock
The Children's Museum of Boston

Erwin O. Tomash
Dataproducts (retired)

The Honorable Paul E. Tsongas
U.S. Senator from Massachusetts

STAFF

Gwen Bell
Director

Jamie Parker
Exhibit Coordinator

Christine Rudomin
Program Coordinator

Gregor Trinkaus-Randall
Archivist

Geri Rogers
Office Manager

David Bromfield
Business Manager

John McKenzie
TX-0 Technician

Beth Parkhurst
Research Assistant

Store Personnel:

Linda Davidson

Merle Insigna

Carol Strecker

The Computer Museum
One Iron Way
Marlboro, Massachusetts 01752
617-467-4036

©1982/THE COMPUTER MUSEUM

INTRODUCTION

This booklet is meant to be an exemplary companion: informative, attractive and user-friendly. People who visit the Timeline, a permanent gallery devoted to the first, one-of-a-kind computers, can use this companion as a supplement to the exhibit, and those who read it as the Winter 82/83 issue of the Report can gain a sense of the Pioneer Computer Timeline.

The concept of developing a permanent gallery devoted to the first computers grew out of the Pioneer Computer lecture series initiated by the curator, Gordon Bell. The lecture series, archived on videotape, was led off on September 23rd, 1979, by Maurice Wilkes on the EDSAC. Then George Stibitz not only talked about the Bell Telephone Relay Computers but reproduced his "Model K" adder for the Museum. John Vincent Atanasoff, the fourth speaker, loaned the breadboard Atanasoff-Berry Computer for display. With these pieces, as well as the major Whirlwind artifacts and the information gathered at the lectures, the idea of assembling them into an integrated exhibit emerged.

The exhibit itself, 100 feet long on the balcony of the Museum's lecture hall, was designed and mounted by Jamie Parker and lighting consultant Christopher Ripman. Their concerns were attractiveness and legibility—both for the person in the lecture hall and the studious visitor—as well as flexibility for growth and change.

Beth Parkhurst carried out the research and compiled the text for both the exhibit and its companion. The Timeline has the specifications spelled out for each machine, an overall view of the machine, and basic descriptive materials. For the companion, Beth chose quotations that would begin to approximate the sentiments of F. C. Williams: "It is fairly easy by reference to such records as survive to describe what had been achieved twenty-five years ago. What is difficult is to recreate the environment of uncertainty and excitement in which those achievements occurred." (F. C. Williams, *The Radio and Electronic Engineer*, 45, 1975.)

Coordinating the companion, my main concern was to provide a picture indicative of the Museum's exhibit. In some cases, I chose photographs of the artifacts on display at the Museum, in others "period" drawings, and in still others the portraits of the machine itself. And I also insisted on the reference page that would indicate where primary materials existed on these pioneer computers. While many of the original sites of the machines maintain an exhibit and archives, the Computer Museum is the only place that has an integrated exhibit of the Pioneer Computers.

Gordon Bell insisted that this companion, as well as the timeline, put the pioneer computers in their historic perspective, and made the comparative table that appears on page 14 and the graph on the cover. In compiling the data, we've selected from sometimes conflicting information and will keep a running corrected table.

The Timeline is not yet complete. The next Pioneer Computer Lecture, by Captain Grace Hopper on the Harvard Mark I is scheduled for April 14. At some time, we will integrate video-taped material into the exhibit; but for now have settled on keeping it available in the archive. Your suggestions, corrections, and donations relevant to this exhibit, the lecture series and the archive are encouraged.

Gwen Bell
Director

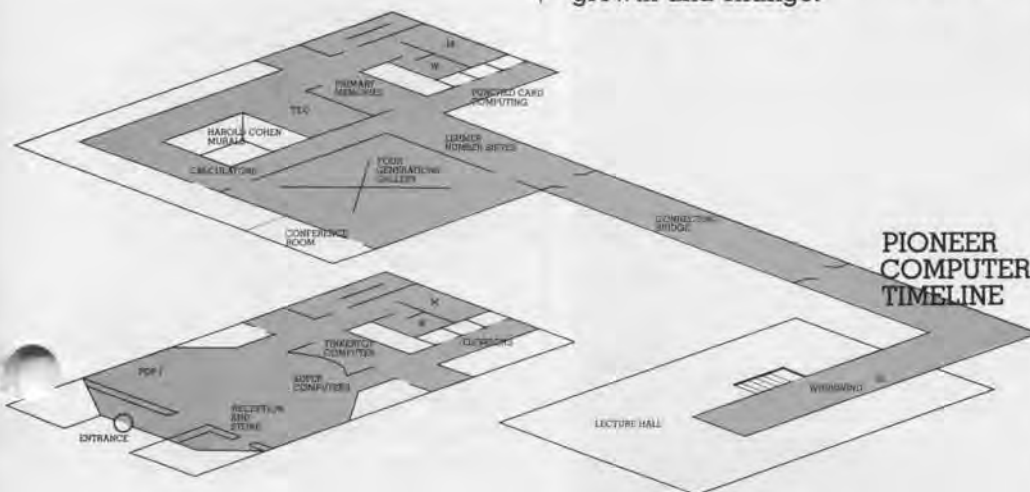

Bell Telephone Laboratories Model I Complex Calculator

George Stibitz worked at Bell Labs as a mathematician in the 1930s. In his spare time, he experimented with using telephone relays for electro-mechanical calculation.

"The original notions that led to the series of relay computers had nothing to do with usefulness. I just wondered whether it would be possible to make such simple things as relays do complicated calculations . . .

"I was then a 'mathematical engineer' at the Bell Telephone Labs, and as such I was asked to look into the magnetic circuits of the telephone relay. As you know, a relay is just an electrically-operated switch that opens and closes one or a dozen electrical circuits.

"While looking at the relay's magnetic circuit I naturally noted the piles of contacts that could be closed or opened when the relay operated. I knew that these contacts could be connected in large and complicated meshes, and when so connected they could do very complicated jobs. So, I liberated a pair of relays from the Labs' junk pile and tried out a few circuits.

"Years before in a freshman

math course I had learned a little about the binary notation for representing numbers. That notation has digits with only two values, such as zero and one, much as the relay has only two 'values': open and closed.

"It occurred to me that perhaps the two positions of a relay could be used to represent the two values of a binary digit. Then perhaps circuits through the contacts of several relays might represent the two values of a binary digit. I soon found out that this was true—two relays could be wired together to add two binary digits.

"I built an adder of the two relays I had borrowed, a couple of dry cells, two flashlight bulbs, and two strips of metal for keys. My wife named it the K-model, after our kitchen table.

"When I took the K-model to the Labs to show the boys, we speculated on the possibility of building a full-size calculator out of relays. Shortly thereafter the relay computer turned serious."

George R. Stibitz, "Early Computers and Their Uses," presented at Computing and Chili-eating Society, 1981

Around that time, the head of the mathematical engineering group came to Stibitz with a problem. Recent developments in filter and transmission line theory were overloading the desk calculator team with complex number work. Could a large-scale relay calculator handle the work?

Bell Labs made Stibitz's relay project official with a budget and circuit designer. The Model I, first in a series of Bell Labs relay calculators and computers, was finished in 1939. Technically, the Model I was not a true computer because it was not controlled by a program. Rather, it was operated directly through a teletype. Although it lacked the speed of the electronic computers that were to appear a few years later, its relays were far less liable to failure than vacuum tubes.

The Bell Labs Model I was the first demonstration of a large-scale digital machine for complex calculation.

"In September 1940, after several months of routine use at the Laboratories, the computer was demonstrated at a meeting of the American Mathematical Society held at Dartmouth College, in Hanover, New Hampshire . . . I gave a short paper on the use and design of the computer after which those attending were invited to transmit problems from a Teletype in McNutt Hall to the computer in New York. Answers returned over the same telegraph connection and were printed out on the Teletype."

George Stibitz, "Early Computers," in *A History of Computing in the Twentieth Century*, ed. N. Metropolis, J. Howlett, and Gian-Carlo Rota, New York, 1980

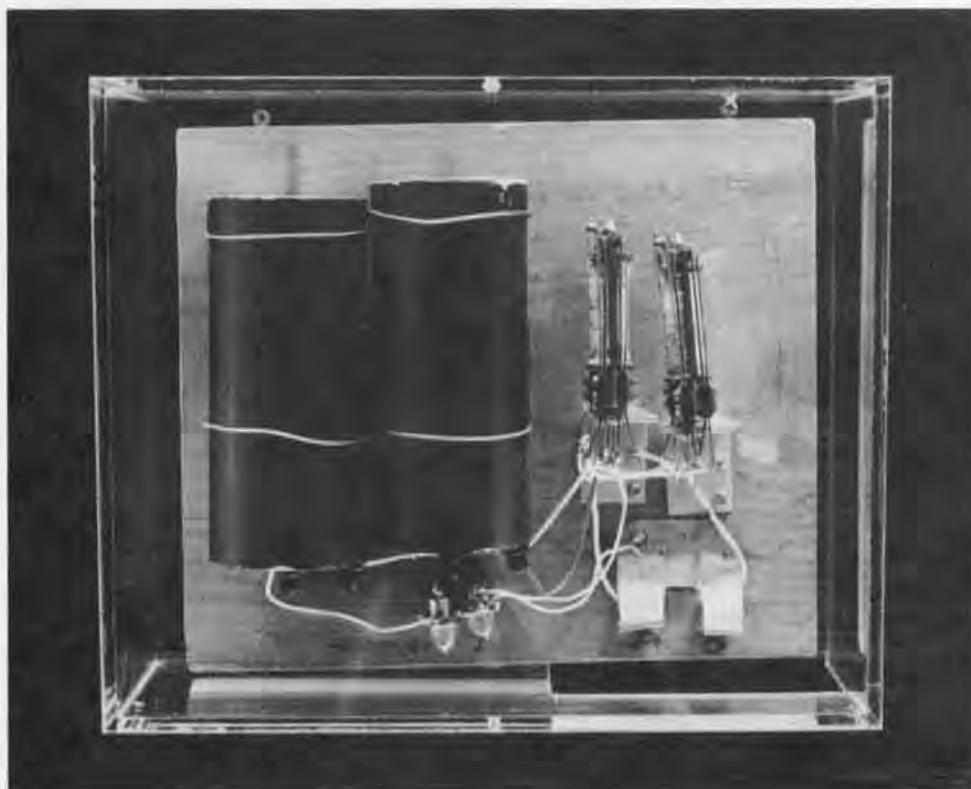

George Stibitz built this replica of his "K-model" for the Computer Museum. (Gift of George Stibitz, D127.80.)

Zuse Z1, Z3

As a civil engineering student in 1930s Berlin, and later as an aircraft engineer, Konrad Zuse had to spend his time performing "big and awful" calculations. Theoretical advances that would change civil engineering from "cut-and-try" to science were starting to appear, but were not being applied because of the volume of computation required in the new approach. Zuse decided to build calculating machines to solve these problems automatically.



Konrad Zuse examines a program tape.

"The work proceeded almost parallel to, but quite independently of, the developments in the United States."

Konrad Zuse, "Some Remarks on the History of Computing in Germany," in *A History of Computing in the Twentieth Century*, ed. N. Metropolis, J. Howlett, and Gian-Carlo Rota, New York, 1980.

"Zuse describes . . . how his work was carried out in ignorance of that of his predecessors, or even the contemporary work by Dirks in Germany on magnetic storage systems . . . During the war the various American computer projects were of course subject to strict security measures; it was only a photograph that German Military Intelligence had obtained of the Harvard Mark I which eventually alerted Zuse to the fact that the Americans had developed some sort of large scale tape-controlled computer. Nothing however prepared him for the post-war release of information about ENIAC, which with its 19,000 valves far surpassed anything that he or Schreyer had ever contemplated attempting to construct."

Brian Randell, *The Origins of Digital Computers*, 3rd ed., Berlin, 1982.

The designs Zuse began in 1934 led to a series of machines that included the first program-controlled computer. He built an experimental mechanical computer, the Z1, in the family living room. The Z1, completed in 1938, was followed in 1940 by the Z2, a prototype electro-mechanical computer built with second-hand telephone relays.

The Z3, a full-scale relay computer, was running in 1941. For the first time, the German government aided with funding. This machine had most of the basic features associated with a conventional computer, including memory and a form of program control. Like Stibitz's electro-mechanical calculator, the Z3 was several orders of magnitude slower than the first electronic computers. Its program was external, coded on punched film. Two special-purpose models, the S1 and S2, were used in aircraft design.

These first machines were destroyed in the war. At the war's end, Zuse learned about the American computer ENIAC, and an American observer published a description of a preliminary version of Zuse's next relay machine, the Z4. It was not until the 1960s that an English-language account of Zuse's first machines appeared.

Programs were punched on recycled motion picture film.



ABC Atanasoff Berry Computer

Beginning in 1935, John Vincent Atanasoff, a physics professor at Iowa State College, pioneered digital electronics for calculating. His students were working with linear partial differential equations, and he experimented with analog, then digital calculators to aid in their solution.

"I tried again and again to sort these concepts out. Nothing seemed to work. After months of work and study I went to the office again one evening but it looked as if nothing would happen. I was extremely distraught. Then I got in my automobile and started to drive. I drove hard so I would have to give my attention to driving and I wouldn't have to worry about my problems.

"When I finally came to earth I was crossing the Mississippi River, 189 miles from my desk. You couldn't get a drink in Iowa in those days, but I was crossing into Illinois. I looked ahead and there was a light and, of course, it was a tavern. I went in and got a drink, and then I noticed that my mind was very clear and sharp. I knew what I wanted to think about and I went right to work on it and worked for 3 hours, and then got in my car and drove slowly back to Ames.

"I had made four decisions in that evening at the Illinois road

Atanasoff built this simple model of the ABC to demonstrate his concepts of digital computation. The number stored in one of the capacitor drums is added to or subtracted from the number stored in the other drum. (On loan from J. V. Atanasoff, X12.80.)

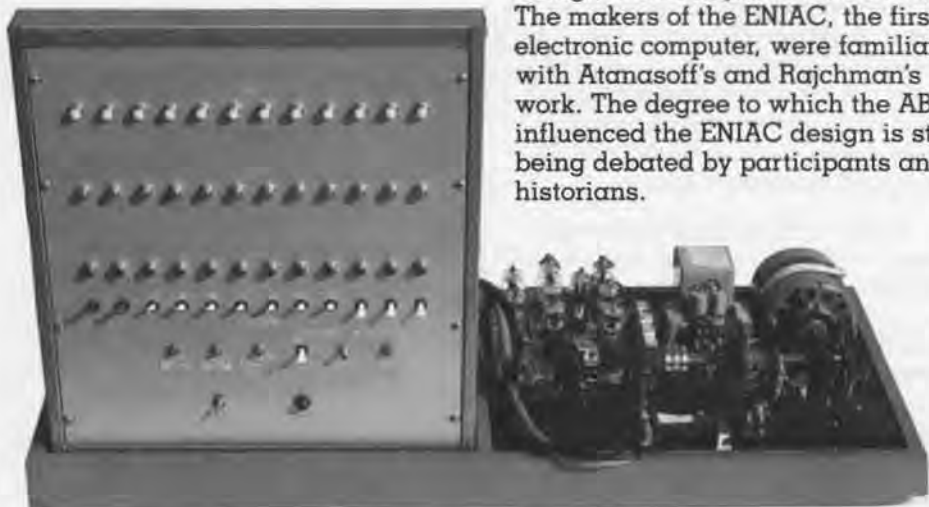

house: use electricity and electronics—that meant vacuum tubes in those days; use base 2, in spite of custom, for economy; use condensers, but regenerate to avoid lapses; compute by direct action, not by enumeration."

John Vincent Atanasoff, Pioneer Computer Lecture, at The Computer Museum, November 11, 1980



Professor Atanasoff lecturing to students at Iowa State University in the late 1930s.

Atanasoff and graduate student Clifford Berry built a prototype ABC (Atanasoff-Berry Computer) in 1939, and a full-scale model in 1942. Like the Bell Labs Model I, the ABC was not a computer in the modern sense, since it lacked program control and was not general purpose.

The ABC was the first of several proposals to use electronics for calculation or logic in the decade after Atanasoff began investigations in 1935. Other projects and proposals included those of Bush and Crawford both at M.I.T.; Zuse and Schreier in Berlin; the British foreign office; Rajchman at R.C.A. The makers of the ENIAC, the first electronic computer, were familiar with Atanasoff's and Rajchman's work. The degree to which the ABC influenced the ENIAC design is still being debated by participants and historians.

IBM ASCC (Harvard Mark I)

The IBM ASCC (Automatic Sequence Controlled Calculator), also known as the Harvard Mark I, began in the mind of Harvard instructor Howard Aiken, and was realized by a team representing Harvard, the U.S. Navy, and IBM.

"The desire to economize time and mental effort in arithmetical computation, and to eliminate human liability to error, is probably as old as the science of arithmetic itself . . .

"The intensive development of mathematical and physical sciences in recent years has included the definition of many new and useful functions, nearly all of which are defined by infinite series or other infinite processes. Most of these are tabulated inadequately and their application to scientific problems is retarded thereby.

"The increased accuracy of physical measurement has made necessary more accurate computation. Many of the most recent scientific developments are based on nonlinear effects. All too often the differential equations designed to represent these physical phenomena may be solved only by numerical integration. This method involves an enormous amount of computational labor. Many of the computational difficulties with which the physical and mathematical sciences are faced can be removed by the use of suitable automatic calculating machinery.

"The development of numerical analysis, including the techniques of numerical differentiation and integration, and methods for solving ordinary and partial differential equations have reduced, in effect, the processes of mathematical analysis to selected sequences of the five fundamental operations of arithmetic: addition, subtraction, multiplication, division, and reference to tables of previously computed results. The automatic sequence controlled calculator was designed to carry out any selected sequence of these operations under completely automatic control."

Howard Aiken and Grace Hopper
1946 *Electrical Engineering*

Inspired by Charles Babbage's nineteenth-century "Analytical Engine," the Harvard Mark I was mostly mechanical. Counter wheels were electro-mechanical, and connections between units were electrical. An external program punched on tape controlled operation; conditional branches were not possible when the machine was first in operation. The machine was largely built of standard IBM equipment. It was completed at IBM in 1943, and moved to Harvard in 1944.

The Harvard Mark I's contribution was not in its technology—the electronic ENIAC, which would surpass the Harvard Mark I's speed by several orders of magnitude, was under construction when the Mark I was being dedicated.



Re-assembling the machine at Harvard, March 10, 1944.

"It is important because it was the first large scale digital calculator ever built and also because it stimulated the imagination and interest of the world and thus gave impetus to the desire for more and better computing machines."

G. Truman Hunter, "Modern Computing Machines," *Journal of the Franklin Institute*, 1952.

"If you hated Hitler enough, you would fight on against fearful odds. You considered not just the small probability of success, but the large payoff if you were successful."

I. J. Good, "Pioneering Work on Computers at Bletchley," in *A History of Computing in the Twentieth Century*, ed. N. Metropolis, J. Howlett, and Gian-Carlo Rota, New York, 1980.



Pulley from a Colossus tape drive. (Gift of Toby Harper, X49.82.)

This spirit motivated the British Foreign Office's cryptanalytic effort at Bletchley Park. German forces relied on variants of the ENIGMA machine for enciphering in World War II. The simplest version of the ENIGMA had 9×10^{20} initial settings, so breaking the cipher was an awesomely complex process. The British built a series of machines to decipher intercepted German messages. The culmination of the series was the Colossus line, electronic machines with many of the features of the computer, including electronic circuits for Boolean logic, counting, and binary arithmetic; automatic operation, with logic functions set with plugs and switches, or conditionally selected by electro-mechanical relays; and electronic registers changeable by an automatically controlled sequence of operations.

The first official release of information on the Colossus was not until 1975. Because of this secrecy, the Colossus did not directly influence the computer projects which flourished in England and the

United States after the war. The Bletchley Park effort, however, did turn out a number of scientists experienced in electronics and logic. F. C. Williams, head of the postwar Manchester University computer project, remembered help he received from two Bletchley alumni who were also familiar with American computer projects: "Tom Kilburn and I knew nothing about computers, but a lot about circuits. Professor Newman and Mr. A. M. Turing in the Mathematics Department knew a lot about computers and substantially nothing about electronics. They took us by the hand and explained how numbers could live in houses with addresses and how if they did they could be kept track of during a calculation."

F. C. Williams, "Early Computers at Manchester University," *Radio and Electronic Engineer*, 1975

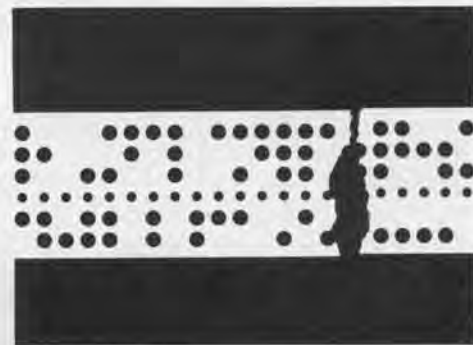

Intercepted German messages were punched on paper tape and read into the Colossus photoelectrically.

"The value of the work I am sure to engineers like myself and possibly to mathematicians like Alan Turing, was that we acquired a new understanding of and familiarity with logical switching and processing because of the enhanced possibilities brought about by electronic technologies which we ourselves developed. Thus when stored program computers became known to us we were able to go right ahead with their development."

T. H. Flowers, letter to Brian Randell, February 15, 1972; quoted in B. Randell, "The Colossus," in *A History of Computing in the Twentieth Century*, ed. N. Metropolis, J. Howlett, and Gian-Carlo Rota, New York, 1980.

Each of these earlier machines had some of the features of the electronic computer. In the ENIAC, these features—electronic, high-speed operation, general-purpose capability, and program control—were combined. It is usually regarded as the first true electronic computer. The major difference between the ENIAC and later computers was that it was programmed by plugs and switches, rather than running a stored program.

The ENIAC, funded by the Army Ballistics Research Laboratory at the University of Pennsylvania's Moore School, used electronics on an unprecedented scale. Its 18,000 vacuum tubes belied the criticism that, given the failure rate of vacuum tubes, one or more tubes would fail before a computation was completed. The success of electronics for large-scale computation inspired a number of postwar computer projects.

The ENIAC was moved to the Army's Aberdeen Proving Ground after a year of operation at the Moore School. R. F. Clippinger, a mathematician who devised some of the first applications at Aberdeen, recalled:

"I had a couple of girls with desk calculators working out the test case that I would use to find out if I was getting the right answers from the ENIAC. It took them two man-years to do one solution. We put it on the ENIAC, and the ENIAC ran off a case very hour . . .

"You have to realize that the Aberdeen Proving Ground was the

The ENIAC team, headed by J. Presper Eckert and John Mauchly, included a dozen engineers and programmers. Designer Arthur Burks looks on as a program is set up on the ENIAC with plugs and switches.

cradle of a whole lot of computers: the EDVAC, ORDVAC, and a bunch of others. But even after they were delivered, the ENIAC continued to work for about ten years. There was a period when the ENIAC was the only computer working. A lot of others were on the drawing boards or in the mill being engineered, but not working."

R. F. Clippinger, gallery talk at the Computer Museum, September 26, 1982



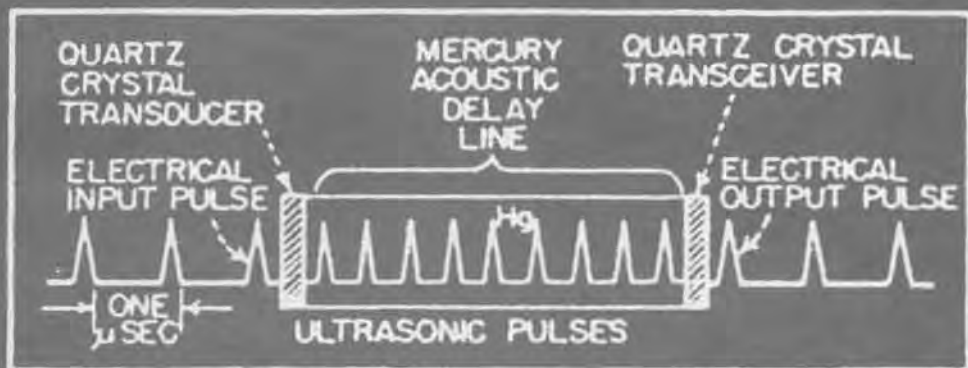

The EDVAC was the successor to the ENIAC. While the ENIAC was being built, its designers realized the potential of the stored program. They began designing a new computer, and were soon joined by distinguished mathematician John von Neumann.

The question "Who invented the program?" has been answered many ways. It cannot be attributed to any single person, but seems to have arisen in the course of conversations among ENIAC project members; other researchers may also have independently conceived the idea. Arthur Burks, who worked on the ENIAC, beginning of the EDSAC, and with John von Neumann on the IAS computer, made this assessment of the process of making the stored program practical.

"There were two main steps. Pres and John (Eckert and Mauchly, of ENIAC) invented the circulating mercury delay line store, with enough capacity to store program information as well as data. Von Neumann created the first modern order code and worked out the logical design of an electronic computer to execute it."

Arthur W. Burks, "From ENIAC to the Stored-Program Computer," in *A History of Computing in the Twentieth Century*, ed. N. Metropolis, J. Howlett, and Gian-Carlo Rota, New York, 1980.

The mercury delay line memory, borrowed from radar to utilize as computer memory, was the key device that made the stored program practical. The ENIAC had only twenty words high-speed memory capacity, using expensive vacuum tubes—far too few to store programs and data. In contrast, each delay line could hold hundreds of words, with bits circulating as ultrasonic pulses in a column of mercury. When each bit reached the end of the column, it was converted to an electrical signal, where it was cleaned up and could be read.

Von Neumann's write-up of the EDVAC group's discussions

was widely circulated in draft. The Moore School's 1946 summer lecture series on the EDVAC design also helped publicize the idea of the stored program computer. The EDVAC, while still in its design stage, directly or indirectly influenced all postwar computer projects.

The EDVAC's theoretical design and construction stage lasted from 1944 to 1951.

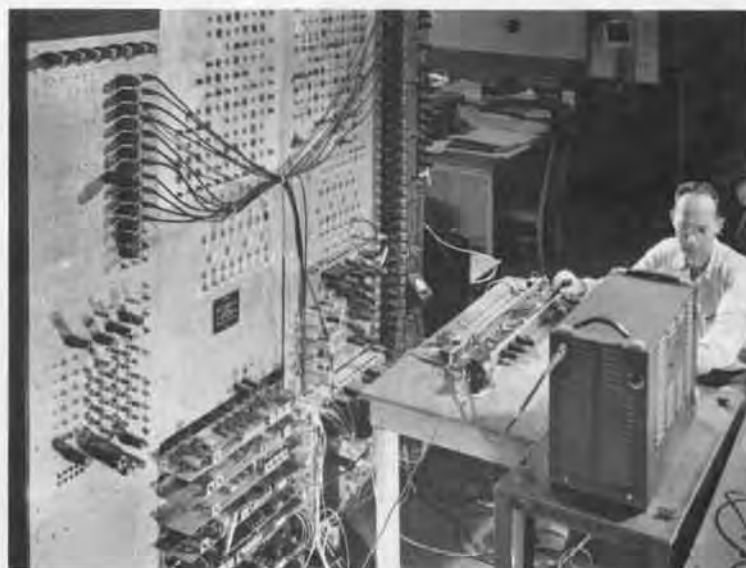



John von Neumann left the EDVAC project to return to the Institute for Advanced Study, bringing with him Arthur Burks and Herman Goldstine. The three elaborated stored program computer design with the draft of "Preliminary Discussions of the Logical Design of an Electronic Computing Instrument."

The IAS Computer introduced asynchronous operation. For fast memory, it used the Williams tube, a CRT memory developed at Manchester University. The Williams tube was used in serial mode at Manchester; the IAS Computer was first to use it in parallel.

One of the IAS Computer's most significant contributions was as a pattern for other computer projects. Julian Bigelow, who was the computer's chief designer, recounts: "Another feature of the arrangement for financial support [by military agencies and the Atomic Energy Commission] provided that, as sections of the computer were successfully developed, working drawings would be sent out by our engineering group to five other development centers supported by similar government contracts, notably to Los Alamos Laboratory, the University of Illinois, Oak Ridge National Laboratory, Argonne National Laboratory, and the Rand Corporation. For the first year or so this requirement that what we produced was in effect going to be duplicated at five distinguished laboratories elsewhere added to the anxieties of the IAS team, espe-

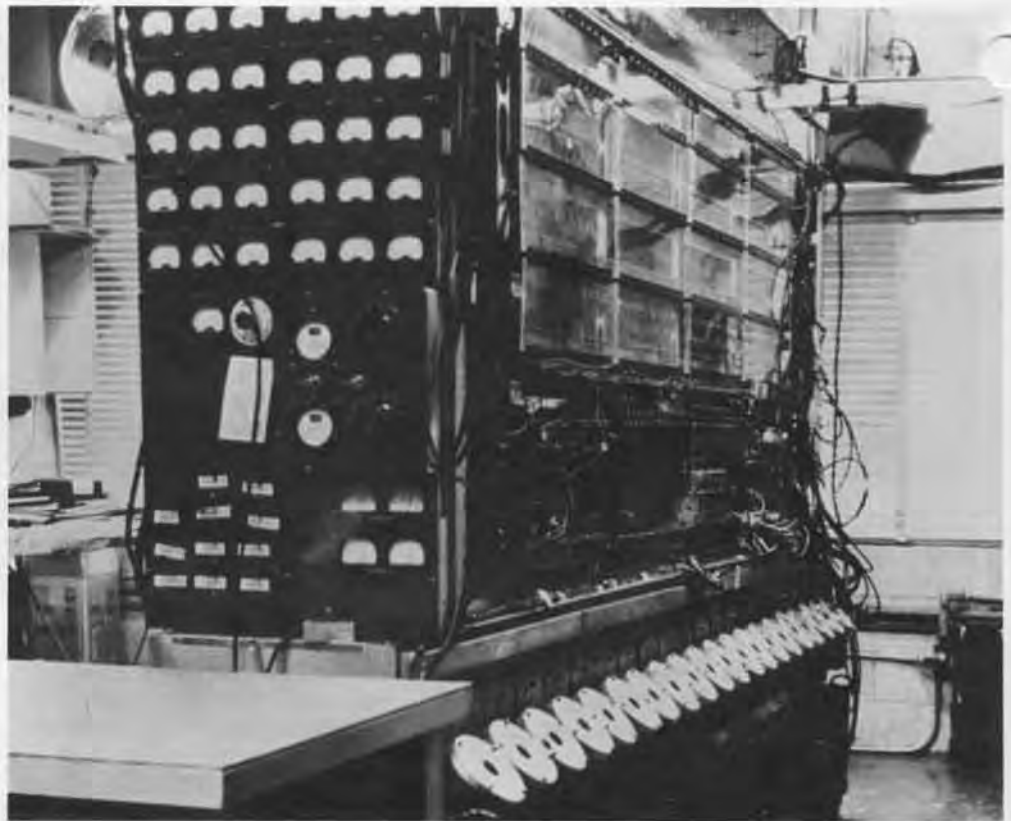

cially since these correspondents were mostly well established and supported by facilities and resources wholly lacking *chez nous*. We anticipated that any mistakes we might make in sending out piecewise the fruits of our efforts would thereby be exposed to possibly hostile or competitive criticism, leaving us no place to hide, but in fact problems of this sort never arose, and communication with all people at these laboratories was entirely friendly and stimulating."

Julian Bigelow, "Computer Development at I.A.S. Princeton," in *A History of Computing in the Twentieth Century*, ed. N. Metropolis, J. Howlett, and Gian-Carlo Rota, New York, 1980.

The IAS computer.

"The EDSAC is based on principles first enunciated in an unpublished report . . . in which ideas for a machine known as the EDVAC were set out."

Maurice Wilkes "Programme Design for a High Speed Automatic Calculating Machine," Journal of Scientific Instruments 1949.

By 1949, a number of computers were underway. Maurice Wilkes, Director of Computation at Cambridge University, was the first to complete a machine with the first program running on May 6th of that year. Maurice Wilkes started the project on his return from the 1946 Moore School lectures on the EDVAC design. Returning to Cambridge University, he set up the Computation Laboratory and started work on a stored program computer. Wilkes used existing technologies to get a machine up and running. His decision on memory technology was characteristic of this design philosophy: "We used the mercury delay-line because it was really the only thing you could count on at the time."

Maurice Wilkes, gallery talk, at The Computer Museum, July 7, 1982

EDSAC memory delay lines plugged into this tank cover. (On loan from the Science Museum, London.)

"We realized that building the machine was only the start of the project; that there was a great deal to be learnt about writing programs, about how to use the machine for numerical analysis, numerical calculation, and all the rest of it . . . As soon as we started programming, we found to our surprise that it wasn't as easy to get programs right as we had thought. Debugging had to be discovered. I can remember the exact instant when I realized that a large part of my life from then on was going to be spent in finding mistakes in my own programs."

Maurice Wilkes, Pioneer Computer Lecture, The Computer Museum, September 21, 1979

Valves (the English equivalent of vacuum tubes) on the EDSAC memory driver. Maurice Wilkes is on the back cover holding the memory driver's wiring. (On loan from the Science Museum, London.)

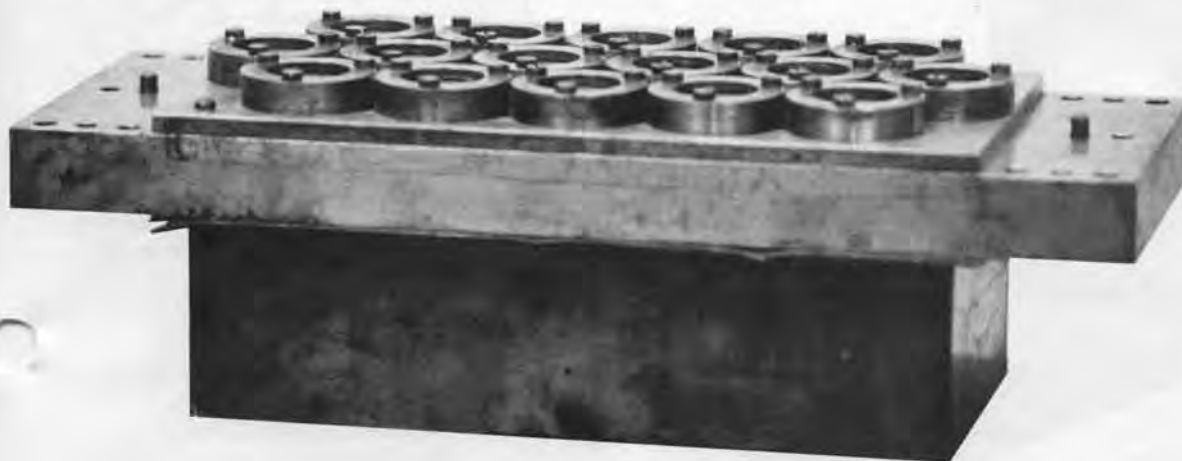

Computer work began at Manchester University in late 1946. F. C. Williams and Thomas Kilburn's first project was to build a new kind of memory, one that was large enough to store programs and data, but faster than the mercury delay line. Several investigators, most notably Jan Rajchman of RCA, had been working on cathode-ray tube memory. Williams and Kilburn solved a major drawback to the CRT, i.e., that the charged spots that represented bits only stayed on the screen for a few instants before dissipating. "Looking back, it is amazing how long it took to realize the fact that if one can read a record once, then that is entirely sufficient for storage, provided that what is read can be immediately rewritten in its original position."

F. C. Williams and T. Kilburn,
paper presented at Manchester
University Computer Inaugural
Conference, 1951

The Manchester group built an experimental prototype to test the Williams tube. The "baby machine" ran its first program in June 1948. The machine was expanded in several stages, and the full-scale computer was complete in late 1949. Williams described its not-quite-automatic operation:

"The two-level store [fast Williams tube and slow magnetic drum] I have referred to was indeed



on two levels. The electronic store was in the magnetism room and the magnetic store in the room above. Transfers between the stores were achieved by setting switches, then running to the bottom of the stairs and shouting, 'We are ready to receive track 17 on tube 1.' The process was repeated for tube 2 and the machine set working. When the machine wished to disgorge information, it stopped and the reverse process was initiated."

F. C. Williams, "Early Computers at Manchester University, *Radio and Electronic Engineer*, 1975

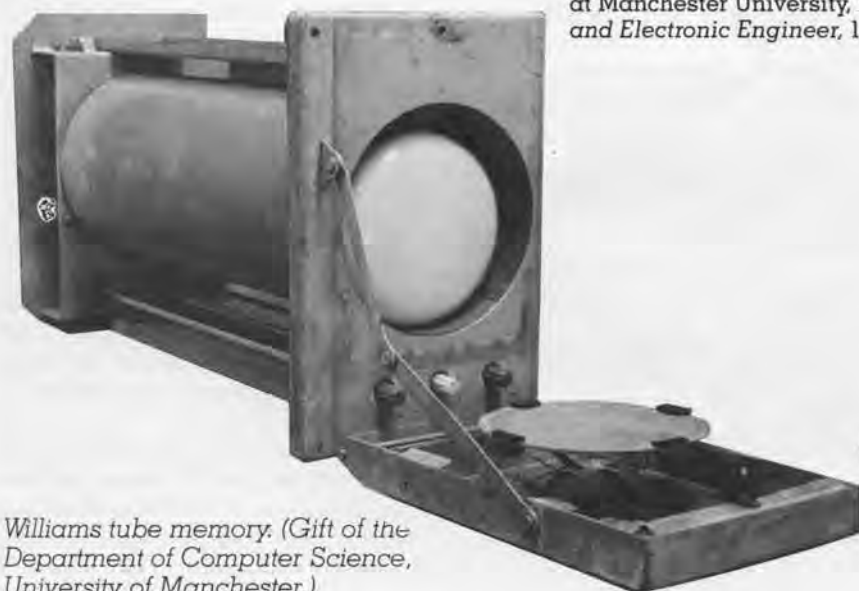

Williams tube memory. (Gift of the Department of Computer Science, University of Manchester.)

Graduate student Dai Edwards.
A Williams tube set in the machine
can be seen in the foreground.

Williams tube memory was borrowed by several computers of the day, including the IAS Computer. Julian Bigelow, head of engineering design for the IAS project, recalled his visit to see the Manchester Computer in its early state:

"My visit to Manchester was a delightful experience; F. C. Williams was a true example of the British 'string and sealing wax' inventive genius, who had built a primitive electronic computer from surplus World War II radar parts strictly on his own inspiration—in the middle of which were two cathode-ray tubes storing digits in serial access mode—the 'Williams memory.' I can remember him explaining it to me, when there was a flash and a puff of smoke and everything went dead, but Williams was unperturbed, turned off the power, and with a handy soldering iron, replaced a few dangling wires and resistors so that everything was working again in a few minutes."

Julian Bigelow, "Computer Development at I.A.S. Princeton," in *A History of Computing in the Twentieth Century*, ed. N. Metropolis, J. Howlett, and Gian-Carlo Rota, New York, 1980

Before any of the stored program computers had been completed, the National Bureau of Standards decided to procure two computers for its own use. After reviewing university projects and proposals from nascent computer companies, Standards decided to build their own machines.



SEAC console.

The SEAC (Standards Eastern Automatic Computer), built in Washington, had two aims. One was to be operational as soon as possible to run programs for the Bureau of Standards. The second

objective was to be a laboratory for testing components and systems, since the Bureau of Standards might be called on to set standards relating to computers.

SWAC (Standards Western Automatic Computer) was built at the Institute for Numerical Analysis in Los Angeles. Its main objective was to be finished as soon as possible, using as much already-developed technology as possible. Project leader Harry Huskey wrote, "The plan was to build a computer with the minimum of circuit development. Thus, the circuits in the arithmetic unit were derived from Whirlwind circuits, and the development of the memory circuits depended heavily on the published work of F. C. Williams of Manchester University."

Harry D. Huskey, "The National Bureau of Standards Western Automatic Computer (SWAC)," in *A History of Computing in the Twentieth Century*, ed. N. Metropolis, J. Howlett, and Gian-Carlo Rota, New York, 1980

SEAC was the first computer to use all-diode logic, pointing the way for the solid-state computers of later years. Diodes were much more reliable than vacuum tubes. The SEAC, however, required a good deal of maintenance, like all computers of the day: "We actually had much more trouble from bad solder joints than we ever had from vacuum tubes, diodes, or delay lines. I can well remember that we

established two standard debugging techniques. After about two hours a day of preventive maintenance, we would start a test program running. Then we applied the 'stir with a wooden spoon' technique, which consisted of taking something like a wooden spoon and going around the computer, tapping everything you could see. If the test program stopped, you had found something. When that test was finally passed, we applied the Bureau of Standards' 'standard jump.' We were in a building with wooden floors that were not difficult to shake, so the standard jump consisted of jumping up in the air about 15 cm and coming down on the floor as hard as possible. If that test was passed, the machine was ready to tackle a computational program—and even more interesting bugs would show up."

Ralph J. Slutz, "Memories of the Bureau of Standards' SEAC," in *A History of Computing in the Twentieth Century*, ed. N. Metropolis, J. Howlett, and Gian-Carlo Rota, New York, 1980

SEAC was the first of stored program computer to be completed in the United States, followed shortly by SWAC. With the first English computers, the Standards computers reassured workers on other contemporary computer projects of their feasibility.

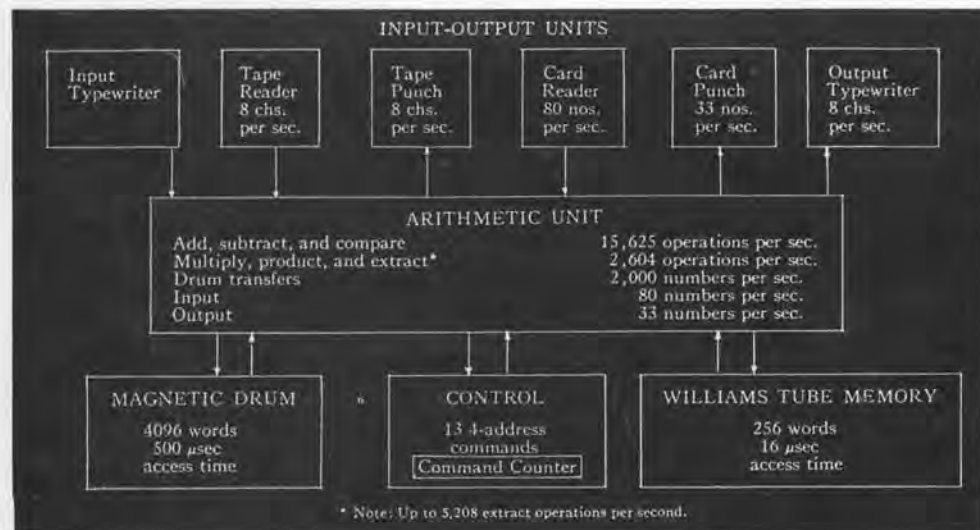

SWAC block diagram.

In 1944, the Massachusetts Institute of Technology contracted with the Navy to build a universal aircraft flight simulator/trainer. Jay Forrester of the M.I.T. Servomechanisms Lab became director of the project. By 1945, the original conception of an analog machine was dropped, and the Navy ap-

An elaborate system of marginal checking identified hardware problems before they affected computational accuracy.

At the same time, new military applications which demanded higher-than-ever reliability were emerging. The Cold War was at its

25 microseconds) thus increasing the speed of computer operation."

M.I.T. Project Whirlwind, Summary Report #35, 1953, p. 33. Institute Archives and Special Collections, M.I.T. Libraries, Cambridge, MA.

Whirlwind was thus the first

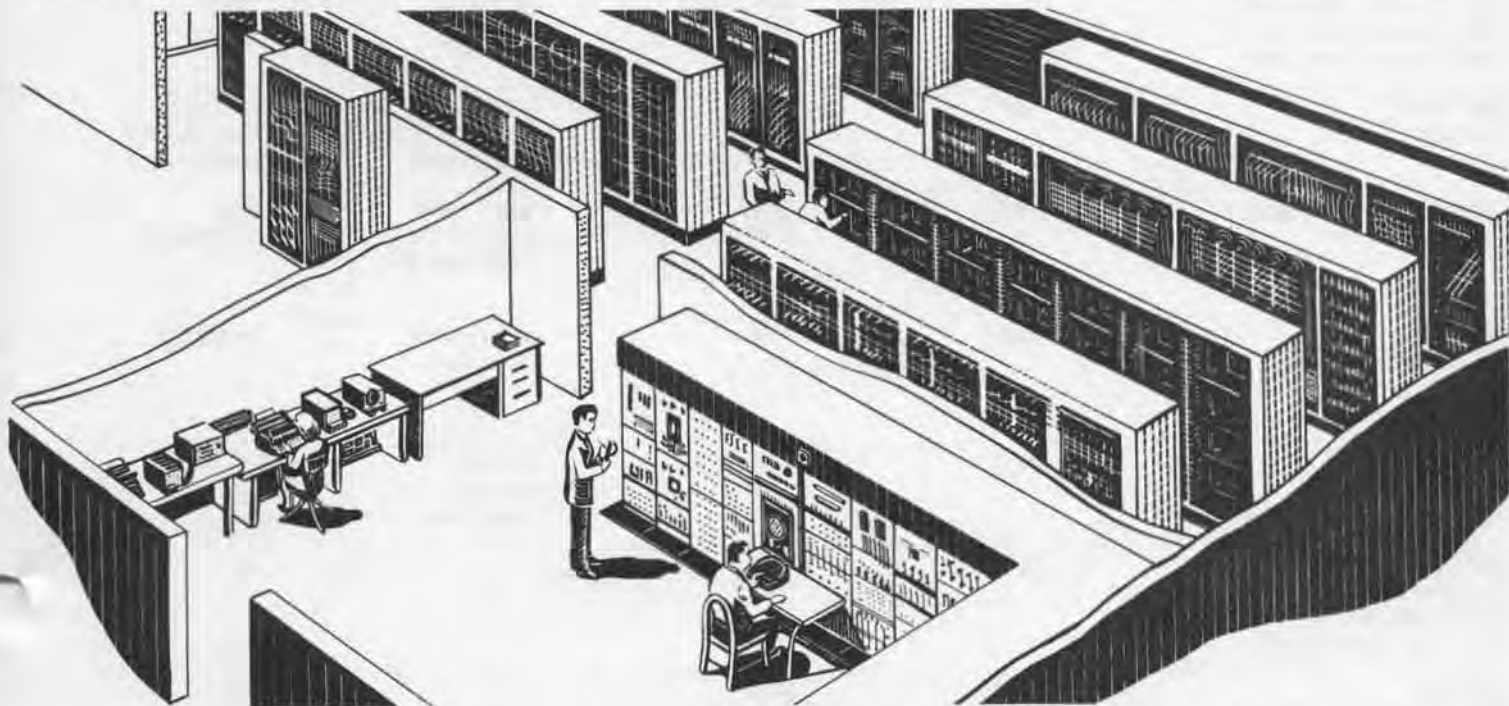

proved construction of a digital computer in 1946. A general-purpose computer could take care of not only flight simulation calculations, but a variety of other scientific and engineering applications. Whirlwind was completed in stages; the entire central machine was working in 1951.

The most important legacy of the flight-simulator concept was Whirlwind's real-time design. To allow the instantaneous response needed for flight simulation, Whirlwind originally used its own version of cathode-ray tube memory, at that time the fastest available type of memory. It was also, in the words of a 1952 project summary report, "the most important factor affecting reliability of the Whirlwind I system."

M.I.T. Project Whirlwind, Summary Report #31, 1952, p. 6. Institute Archives and Special Collections, M.I.T. Libraries, Cambridge, MA.

height, and the U.S. military was on guard against atomic attack. Whirlwind, funded by the Office of Naval Research and then by the Air Force, was part of the defense network; the production version of the Whirlwind II design, named AN/FSQ-7, was to become part of the SAGE System. Project members, dissatisfied with CRT memory performance, researched a substitute.

Several researchers in the late 1940s, including Jay Forrester, conceived the idea of using magnetic cores for computer memory. William Papian of Project Whirlwind cited one of these efforts, Harvard's "Static Magnetic Delay Line," in an internal memo. Core memory was installed on Whirlwind in the summer of 1953. "Magnetic-Core Storage has two big advantages: (1) greater reliability with a consequent reduction in maintenance time devoted to storage; (2) shorter access time (core access time is 9 microseconds; tube access time is approximately

full-scale computer to run on core memory, the mainstay of primary memories until the 1970s.

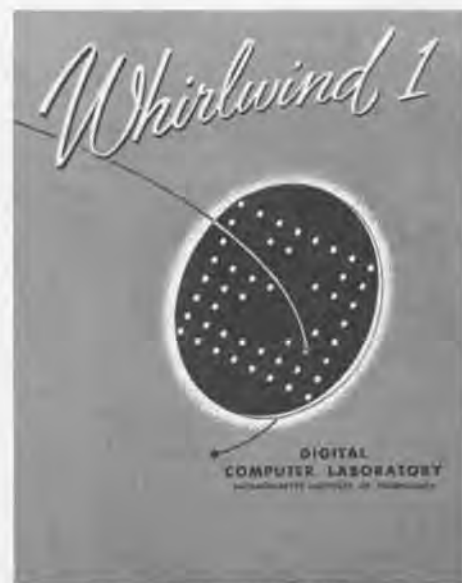

The Pioneer Computers

Comparative Statistics

	Start up	Completion	Program	Word length
Bell Labs Model I George Stibitz at Bell Telephone Laboratories	1939	10/39	4 function, complex arithmetic calculator	8 digits
Zuse Z3 Konrad Zuse	1939	1941	punched film	22 bits, flt. pt.
ABC John Vincent Atanasoff and Clifford Berry at Iowa State University	12/37	12/39 prototype 1942	fixed, equation solver	50 bits
IBM ASCC Harvard Mark I	1937	8/44	punched tape, function table, plugboard	23 digits also double precision
Colossus (Mark I & II) Bletchley Park	1943	12/43 (I) 5/44 (II)	telephone plugboard (I), switches (II)	5 bit characters
ENIAC Moore School, University of Pennsylvania	1943	2/46	plugboard, switches	10 digits
EDVAC Moore School, University of Pennsylvania	1/44	1951	stored program computer	44
IAS Computer Institute for Advanced Study, Princeton University	6/46	7/51		40
EDSAC Maurice Wilkes at Cambridge University	10/46	5/49		36
MANCHESTER U. MARK I Manchester University	1947	6/48 prototype 7/49		40
PILOT ACE National Physical Laboratory, Teddington, England	10/48	5/50		32
SEAC National Bureau of Standards	6/48	5/50		45
SWAC National Bureau of Standards Institute for Numerical Analysis	1/49	7/50		41
Whirlwind Servomechanisms Laboratory, MIT	1945	1951		16

In many cases, the material in this table was compiled from data sheets filled out by a person who worked on the machine. In the literature conflicting published data was found. The Museum requests corrections to this table and will keep the most accurate updated version on file.

Memory size (words)	Add time	Memory type [secondary]	I/O	Technology	Floor space est. sq. ft.
4 working registers	6s for complex x (4 products)	none	Teletype or paper tape	450 relays	50
64	2s	relays	punched film, keyboard, lights	2600 relays	100
2 x (30 + 2 spare)	32 in 1s	drum of capacitors	cards	vacuum tubes	12.5
72 counters 60 switches	.3s	relays, switches	paper tape, cards, typewriters	relays, motor-driven cam, clock	51 ft long, lg. room
500 characters	.2ms	5 hole paper tape, plugboard, keys & cords	photo-electric paper tape, switches, lights	1500 vacuum tubes, relays (I) 2400 vacuum tubes 800 relays (II)	200 (II)
20 accumulators, 312 function table	.2ms	counter tubes, relays, switches	cards, lights, switches, plugs	18,000 vacuum tubes, 1500 relays	1,000
1024 (8 x 128)	.85ms	delay lines, [magnetic drum (1953)]	paper tape	3,500 vacuum tubes, 7,000 diodes	400
1024	.09ms	crt	Teletype	2,600 vacuum tubes	100
512	1.4ms	delay lines	paper tape, teleprinter	3,000 vacuum tubes	med. room
128 + 1024	1.8ms	crt, [magnetic drum]	paper tape, teleprinter, switches	1,300 vacuum tubes	med. room
352	.54ms	delay lines	cards	800 vacuum tubes	12
512 + 512	.86ms	crt, delay lines, [magnetic tape & wire]	paper tape Teletype	1,290 vacuum tubes, 15,800 diodes	150
256	.064ms	crt, magnetic drum	cards, paper tape	2,000 vacuum tubes 2,500 diodes	60
2048	.05ms	crt, core (1953), [magnetic drum & tape]	crt, paper tape, magnetic tape	4,500 vacuum tubes, 14,800 diodes	3,100 lg. rooms

Warning: Use of any data on this table without prior checking with the Museum may lead to the proliferation of inaccuracies.

Primary source books with excellent bibliographies, guiding the reader to great numbers of primary and secondary sources:

C. Gordon Bell and Allen Newell, *Computer Structures: Readings and Examples*, New York, 1971.

B. V. Bowden, Editor, *Faster than Thought, A Symposium on Digital Computing Machines*, New York, 1966.

N. Metropolis, J. Howlett, and Gian-Carlo Rota, Editors, *A History of Computing in the Twentieth Century*, New York, 1980.

Brian Randell, Editor, *The Origins of Digital Computers. Selected Papers*, Third Edition, Berlin, 1982.

Bell Telephone Laboratories Model I

George R. Stibitz, videotape of lecture at The Computer Museum, 1980.

George Robert Stibitz papers, Dartmouth College Library.

Archives, Bell Telephone Laboratories.
G.R. Stibitz, "Calculating With Telephone Equipment." Paper presented at Mathematical Association of America meeting, Hanover, N.H., 1940.

Zuse Z1, Z3

A replica of the Z3 is on exhibit at the Deutsches Museum, Munich.

Konrad Zuse, videotape of lecture at The Computer Museum, 1981.

K. Zuse, *Calculator for Technical and Scientific Calculations Designed According to a Theoretical Plan*. Distributed by the Office of the Publication Board, Department of Commerce, Washington, D.C. (n.d.).

ABC

A simplified model of the Atanasoff-Berry Computer built by J. V. Atanasoff is on exhibit at The Computer Museum. J.V. Atanasoff, videotape of lecture at The Computer Museum, 1980.

Archives, Division of Mathematics, National Museum of American History, Smithsonian Institution, Washington, D.C.

IBM ASCC (Harvard Mark I)

Part of the IBM ASCC is on exhibit at the Harvard Computation Laboratory.

Records of the Computation Laboratory, University Archives, Harvard University, Cambridge, Mass.

Archives, Division of Mathematics, National Museum of American History, Smithsonian Institution, Washington, D.C.

Colossus

T. H. Flowers, videotape of lecture at The Computer Museum, 1981.

See also Randell.

ENIAC

Parts of the ENIAC are on exhibit at the University of Michigan, the National Museum of American History, Smithsonian Institution, and at The Computer Museum.

J. G. Brainerd, videotape of lecture at The Computer Museum, 1981.

Arthur C. Burks, videotape of lecture at The Computer Museum, 1982.

R.F. Clippinger, audiotape of lecture at The Computer Museum, 1982.

"The ENIAC Film." Footage of the ENIAC operating in 1946, with introduction and narration by Arthur Burks. Videotape produced by Arthur Burks and The Computer Museum, 1982.

ENIAC Archives, Moore School of Electrical Engineering, University of Pennsylvania, Philadelphia.

Archives, Division of Mathematics, National Museum of American History, Smithsonian Institution, Washington, D.C.

ENIAC Trial Records. United States District Court, District of Minnesota, Fourth Division: Honeywell, Inc. v. Sperry Rand Corp. et al., No. 4-67 Civ. 138, decided October 19, 1973.

F. Robert Michael, "Tube Failures in ENIAC." *Electronics* 20, 1947.

H.W. Spence, "Systematization of Tube Surveillance in Large Scale Computers." *Electrical Engineering* 70, 1951.

EDVAC

EDVAC Archives, Moore School of Engineering, University of Pennsylvania, Philadelphia.

Archives, Division of Mathematics,

National Museum of American History, Smithsonian Institution, Washington, D.C.

Donald Eadie, "EDVAC Drum Memory Phase System of Magnetic Recording." *Electrical Engineering* 72, 1953.

S. E. Gluck, "The Electronic Discrete Variable Computer." *Electrical Engineering* 72, 1953.

IAS Computer

The IAS Computer is on exhibit at the National Museum of American History, Smithsonian Institution, Washington, D.C.

Mathematics and Natural Sciences Library, Institute for Advanced Study, Princeton, N.J.

Archives, Division of Mathematics, National Museum of American History, Smithsonian Institution, Washington, D.C.

EDSAC

Parts of the EDSAC are on exhibit at The Computer Museum.

M. V. Wilkes, videotape of lecture at The Computer Museum, 1979.

"The EDSAC Film." Produced by Cambridge University Mathematics Laboratory, 1951; with introduction and narration by M. V. Wilkes, 1976.

M. V. Wilkes and W. Renwick, "An Ultrasonic Memory Unit for the EDSAC." *Electronic Engineering* 20, 1948.

Manchester University Mark I

Parts of the Manchester University Mark I are on exhibit at Manchester University.

D.B.G. Edwards, videotape of lecture at The Computer Museum, 1981.

F. C. Williams and T. Kilburn, "A Storage System for Use with Binary Digital Computing Machines." *Proceedings of the IEE* 96, part 2, 1949.

F. C. Williams, T. Kilburn, and G. C. "Tootill," "Universal High-Speed Digital Computers: A Small-Scale Experimental Machine." *Proceedings of the IEE* 98, part 2, 1951.

Pilot ACE

The Pilot ACE is on exhibit at the Science Museum, London.

J. H. Wilkinson, videotape of lecture at The Computer Museum, 1981.

Archives, National Physical Laboratory, Teddington, England.

E. A. Newman, D. O. Clayden, and M. A. Wright, "The Mercury-Delay-Line Storage System of the ACE Pilot Model Electronic Computer." *Proceedings of the IEE* 100, part 2, 1953.

NBS SEAC

Parts of the SEAC are on exhibit at the National Bureau of Standards Museum, Library Division, National Bureau of Standards, Washington, D.C.

Archives, Division of Mathematics, National Museum of American History, Smithsonian Institution, Washington, D.C.

National Bureau of Standards, MDL Staff, "The Incorporation of Subroutines into a Complete Problem on the NBS Eastern Automatic Computer." *Mathematical Tables and Other Aids to Computation* 4, 1950.

National Bureau of Standards, Electronic Laboratory Staff, "The Operating Characteristics of the SEAC." *Mathematical Tables and Other Aids to Computation* 4, 1950.

S. N. Alexander, "The National Bureau of Standards Eastern Automatic Computer." *Proceedings, Joint AIEE-IRE Computer Conference*, Philadelphia, Pa., 1951.

Alan L. Leiner, "Provisions for Expansion

in the SEAC." *Mathematical Tables and Other Aids to Computation* 5, 1951.

Ernest F. Ainsworth, "Operational Experience with SEAC." *Proceedings of the Joint AIEE-IRE-ACM Computer Conference*, New York, December 10-12, 1952.

S. Greenwald, "SEAC Input-Output System." *Proceedings of the Joint AIEE-IRE-ACM Computer Conference*, New York, December 10-12, 1952.

Ruth C. Haueter, "Auxiliary Equipment to SEAC Input-Output." *Proceedings of the Joint AIEE-IRE-ACM Computer Conference*, New York, December 10-12, 1952.

James L. Pike, "Input-Output Devices Used with SEAC." *Proceedings of the Joint AIEE-IRE-ACM Computer Conference*, New York, December 10-12, 1952.

Sidney Greenwald, R.C. Haueter, and S.N. Alexander, "SEAC." *Proceedings of the IRE* 41, 1953.

NBS SWAC

Parts of the SWAC are on exhibit at the National Bureau of Standards Museum and the Museum of Science and Industry, Los Angeles.

Library Division, National Bureau of Standards, Washington, D.C.

Archives, Division of Mathematics, National Museum of American History, Smithsonian Institution, Washington, D.C.

H. D. Huskey, "Characteristics of the Institute for Numerical Analysis Computer." *Mathematical Tables and Other Aids to Computation* 4, 1950.

H. D. Huskey, R. Thorensen, B. F. Ambrosio, and E. G. Yowell, "The SWAC—Design Features and Operating Experience." *Proceedings of the IRE* 41, 1953.

Whirlwind

Parts of Whirlwind are on exhibit at the National Museum of American History, Smithsonian Institution, Washington, D.C., and The Computer Museum.

Jay Forrester, videotape of lecture at The Computer Museum, 1980.

"See It Now: Interview with Whirlwind." Excerpt from Edward R. Murrow's CBS news program, 1951.

"Making Electrons Count." Film produced by MIT, 1953.

MIT Servomechanisms Laboratory Technical Publications File, 1944-1968, (AC-34); MIT Digital Computer Laboratory Records, 1944-1959 (80-36); and Magnetic Core Memory Records, 1932-1977 (MC-140), Institute Archives and Special Collections, M.I.T. Libraries, Cambridge, Mass.

Corporate Archives, MITRE Corporation, Bedford, Mass.

Archives, Division of Mathematics, National Museum of American History, Smithsonian Institution, Washington, D.C.

S. H. Dodd, H. Klemperer, and P. Youtz, "Electrostatic Storage Tube." *Electrical Engineering* 69, 1950.

Jay W. Forrester, "Digital Information Storage in Three Dimensions Using Magnetic Core." *Journal of Applied Physics* 22, 1951.

R. R. Everett, "The Whirlwind I Computer." *Electrical Engineering* 71, 1952.

William N. Papias, "A Coincident-Current Magnetic Memory Cell for the Storage of Digital Information." *Proceedings of the IRE* 40, 1952.

William N. Papias, "The MIT Magnetic-Core Memory." *Proceedings of the Joint IRE-AIEE-ACM Computer Conference*, Washington, D.C., 1953.

J. W. Forrester, "Multicordinate Digital Information Storage Device." U.S. Patent 2,736,880, issued February 28, 1956.

CORPORATE FOUNDERS

Donating \$2,500 or more:

Benton and Bowles
Bolt, Beranek and Newman
Robert Cipriani Associates
Clint Clemens
ComputerWorld
Control Data Corporation
Coopers and Lybrand, Boston
Data General
Digital Equipment Corporation
General Systems Group, Inc.
Intel Corporation
MITRE Corporation
Richard Reno
Schlumberger Foundation
Tobin Vending Service

NEW INDIVIDUAL FOUNDERS:

The Museum welcomes the following who join the first 86 individual founders by donating \$250 or more.

Marlan and Lois Anderson
J. Weldon Bellville
Ted Bonn
James R. Burley
Ed Fredkin
Neil Freeman
Herbert R. J. Grosch
Christoph Horstmann
Ernest M. Huber
Les Lazar
Theodore C.M. Lo, M.D.
William H. Long
Richard Davis Mallery
Gregory L. Nelson
Walter I. Nissen, Jr.
John Ousterhout
Ted C. Park
Jean-Claude Peterschmitt
Robert W. Puffer III
Dorothy E. Rowe
Donald G. Seydel
John F. Shoch
William D. & Carole K. Strecker
Thomas A. Susic
Dr. Stephen A. Szygenda
John Tartar
Professor DVR Vithal

SYMPOSIUM ON ARCHIVING THE HISTORY OF COMPUTING

On May 5 and 6, 1983, the Museum will host a symposium that addresses questions on archiving the history of information processing. The purpose is to share information about activities planned and underway at the museum, institutes, libraries, government agencies, corporations, universities, and individuals.

Attendance will be limited in order to gain a broad cross-section of information. Anyone interested should contact Chris Rudomin at The Computer Museum, (617) 467-7570.

Annual Anniversary
Dinner and Lecture
May 5, 1983

Grace Hopper
on the
Harvard Mark I
April 14, 1983

WATCH THIS SPACE FOR THE ANNOUNCE- MENT OF THE SPRING LECTURE SERIES

IN THE NEXT REPORT.

A newsbrief of the collection



Two important loans were revealed during Maurice Wilkes' recent gallery talk on his reminiscences of early computing: a mercury memory tank cover and memory driver from Cambridge University's EDSAC. The memory driver (pictured) was used on the mercury delay line memory. Wilkes was the Director of Computation at Cambridge, where the EDSAC ran its first program in May of 1949.

The memory driver and the mercury memory tank cover, on loan from the Science Museum, London, are exhibited on the Pioneer Computer Timeline.

The
Computer
Museum

One Iron Way
Marlboro
Massachusetts
01752

Non-Profit
Organization
U.S. Postage
PAID
Marlboro, MA
Permit No. 46

THE COMPUTER MUSEUM REPORT

SPRING/1983

"In competition with the IBM 7094 [it] makes a good showing, especially on economic grounds. It is roughly 10 times faster than the 7094, and costs about 2 cents an hour to operate."

D.H. Lehmer

- 1 The Director's Letter**
Gwen Bell
- 2 D. H. Lehmer's Number Sieves**
Richard Rubinstein
- 5 Inside "The Soul of a New Machine"**
Tracy Kidder and Tom West
- 8 Recollections of the Watson Scientific Laboratory, 1945-1950**
Herbert Grosch
- 13 Museum News**
Field Trip to North Bay
Pray, Mr. Babbage . . .
Founders Program
- 16 Computer Museum Slide Collection**
- 17 Spring "Bits and Bites"**



THE COMPUTER MUSEUM

The Computer Museum is a non-profit, public, charitable foundation dedicated to preserving and exhibiting an industry-wide, broad-based collection of the history of information processing. Computer history is interpreted through exhibits, publications, videotapes, lectures, educational programs, and other programs. The Museum archives both artifacts and documentation and makes the materials available for scholarly use.

The Computer Museum is open to the public Sunday through Friday from 1:00 to 6:00 pm. There is no charge for admission. The Museum's lecture hall and reception facilities are available for rent on a prearranged basis. For information call 617-467-4443.

Museum membership is available to individuals and non-profit organizations for \$25 annually and to businesses for \$125 annually. Members receive the quarterly Report, invitations to all lectures and special programs, new posters, and a ten percent discount in the Museum store.

A Founders program is in effect during the initial two-year period of the Museum, until June 10, 1984. During this period individuals and non-profit organizations may become Founders for \$250 and businesses and charitable Foundations may become Founders for \$2500. Founders receive all benefits of membership and recognition for their important role in establishing the Museum.

THE COMPUTER MUSEUM REPORT (ISSN 0736-5438)

The Computer Museum Report is published quarterly by The Computer Museum, One Iron Way, Marlboro, MA 01752. Annual subscription is part of the membership of the Museum (\$25 per year for individuals and nonprofit organizations and \$125 for corporations).

The purpose is to report on the programs and exhibitions of the Museum. The contents of The Computer Museum Report may not be reproduced without written consent.

The Museum Staff is responsible for the contents of the Report. The opinions expressed do not necessarily represent those of The Computer Museum or its Board of Directors.

The design and production of the Report is done by Benson and Clemons.

BOARD OF DIRECTORS

Kenneth H. Olsen, Chairman
Digital Equipment Corporation

Charles W. Bachman
Cullinet Software Systems

C. Gordon Bell
Digital Equipment Corporation

Gwen Bell
The Computer Museum

Harvey D. Cragon
Texas Instruments

Robert Everett
The Mitre Corporation

C. Lester Hogan
Fairchild Camera and Instrument Corporation

Theodore G. Johnson
Digital Equipment Corporation

Andrew C. Knowles, III
Digital Equipment Corporation

John Lacey
Control Data Corporation

Pat McGovern
ComputerWorld

George Michael
Lawrence Livermore Laboratories

Robert N. Noyce
Intel

Brian Randell
University of Newcastle-upon-Tyne

Edward A. Schwartz
Digital Equipment Corporation

Michael Spock
The Children's Museum of Boston

Erwin Tomash
Dataproducts

The Honorable Paul E. Tsongas
U.S. Senator from Massachusetts

STAFF

Director
Gwen Bell

Exhibits and Archives
Jamie Parker, Coordinator
Susan Kaelin
John McKenzie
Bill Meany
Beth Parkhurst
Meredith Stelling

Programs
Christine Rudomin, Coordinator

Administration
Geri Rogers, Coordinator
David Bromfield
Debbie Sterling

Store
Carole Strecker, Coordinator
Sally Askins
Linda Davidson
Merle Insigna

The Computer Museum
One Iron Way
Marlboro, Massachusetts 01752
617-467-4036

© 1983/THE COMPUTER MUSEUM

PHOTO CREDITS:

Robert Bonifield, Cover, pp. 2, 3, 4;
David Bromfield pp. 3, 12, 14, 15;
Data General Corporation p. 5;
IBM archives pp 8, 9, 10, 11, 12;
MITRE Corporation p. 13.

The *Computer Museum Report* now has an ISSN (an International Standard Serial Number), another benchmark in our development. The purpose of the publication is to report on the Museum's activities with the material in each issue derived directly from our own projects, thus providing a record and a means of communication to our worldwide membership. This issue only covers a part of our fall program of three lectures, seven Sunday afternoon talks, the production of "Pray, Mr. Babbage . . .", the members' field trip to Canada, a variety of additions to the collection, and a number of new products available in the Museum store.

Both the Museum and the Report have seasonal rhythms. Writing this letter during our January-February hibernation, I'm recalling all the wonderful activities of the fall season and anticipating Gene Amdahl's talk that starts our spring season on March 10th. Derrick Lehmer opened the fall lecture series October 7th, 1982 and dedicated the exhibit of his sieve machines to the Museum. No sooner was the exhibit mounted than *The Scientific American* sent a photographer to shoot these unique machines for their November issue. As a result the Museum was given the excellent photos that appear on the cover and in the first article of this Report.

On October 8, 1982, the Museum's first excursion took off for North Bay, Canada to see the AN/FSQ-7. By the time you are reading Gordon Bell's trip report (page 13), the decommission of the Q-7 will have commenced and we will be puzzling over how to fit a representative exhibit of it in the Museum.

The Fall also inaugurated Bits and Bites, a series of informal Sunday afternoon talks, ranging from technical presentations to reminiscences about the everyday use and development of computers. These complement the formal lecture series focusing on significant events in the evolution of information processing. The session "Inside the Soul of a New Machine" with Tom West and Tracy Kidder (reported on page 5) provided an almost anthropological view of the species "computer engineer." Tracy was on the spot to record how Tom behaved at breakfast, as well as at work. In the Spring, the reminiscences of the group that designed the first computer space game will tell the Computer Museum audience why they ever tackled such a project and also provide insights into the everyday environment of a university computer center in 1962.

Often the lectures and talks lead to changing or further developing an exhibit. Herbert Grosch's lecture on IBM's SSEC at Columbia's Watson Laboratory (extracted on pages 8 to 12), the two articles on the SSEC in the October 1982 *Annals of the History of Computing*, and a flurry of letters to the Museum convinced us to add the SSEC to The Pioneer Computer Timeline. With a start up date in January 1948, the SSEC did comparable work to the ENIAC and preceded the EDSAC and Manchester machines.

Feedback from members and visitors also helps the Museum preserve the accuracy of its exhibits. Our exhibit coordinator Jamie Parker keeps an ongoing list of text corrections to make. The original text on the Pioneer Computer Timeline was put up crediting "George" Aiken for the Harvard Mark I, the corrected version with an error from the typesetter read "Harvard" Aiken and finally we got Howard's name correct. Several letters pointed out the inaccurate placement of Amdahl's constant on the cover chart of the Fall Report. The corrected version is reprinted on this page and is also available in color in the slide sets listed on the back page. For longer than I am pleased to report the specifications on the Whirlwind read that it used 150,000 kw of power. A number of visitors took great pleasure in drawing this error to our attention, and in some fanciful moments, I've thought of the deliberate introduction of errors providing ongoing "treasure hunts" for mistakes. But this added confusion is hardly needed. Our goal is the presentation of the clearest picture possible of the history of information processing to provide a perspective of the present and future as if viewed through a rear view mirror.

Gwen Bell
Director

Corrected version, cover Winter 1983 Report.

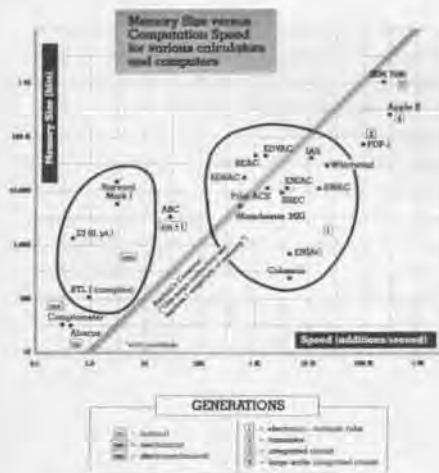

THE PIONEER COMPUTER TIMELINE

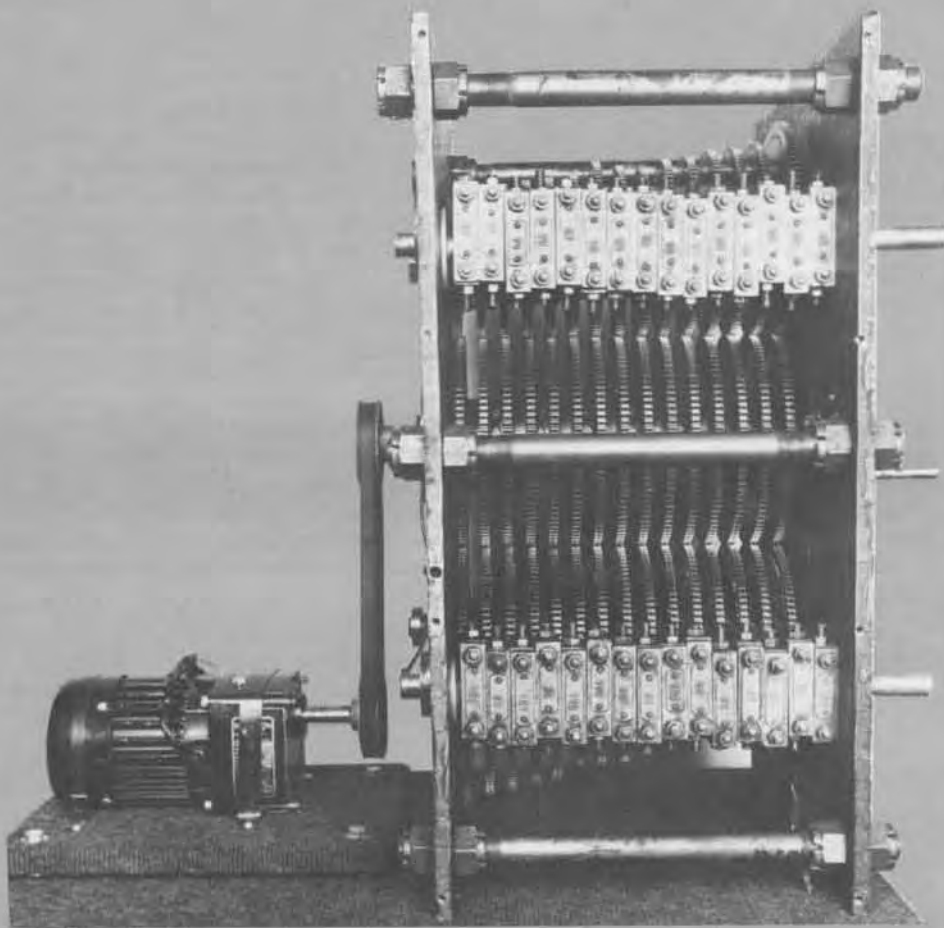

This Photoelectric Number Sieve, built by Dr. Lehmer in 1932, performs 300,000 tests per minute using 30 gears arranged tangentially. Each gear has a number of holes equal to a multiple of a prime. For any problem, all holes that do not represent solutions are plugged with toothpicks. A solution is found when light, originally supplied by an automobile headlight lamp, passes through all 30 wheels. A photoelectric cell detects this brief flash of light, and a vacuum-tube amplifier multiplies the resulting signal 700,000,000 times to stop the motor.

Number sieves perform tests on numbers to eliminate those numbers that cannot be solutions to a problem, and thus find those that are solutions. Dr. Lehmer's machines search numbers sequentially, from any starting point that may be chosen, looking for a number that has an acceptable remainder modulo, each of a number of primes.

Consider the following problem: Find a value of x for which $91894770302976x^2 + 287722528867021824x + 256527596541064768$ is a perfect square.

These large coefficients are not arbitrary numbers. In fact they arise quite naturally in an investigation into the possible factors of the Mersenne number $2^{79} - 1$. The numbers $2^n - 1$ where n is a prime have been the subject of investigation since the time of Euclid. Twelve of these numbers have been proved prime and twelve composite ones have been completely factored. Since 1924 it has been known that if a value of x exists for which the formula above is a square then $0 < x < 39110012$.

D.H. Lehmer explored the problem with his photoelectric number sieve. The problem was considered in each of the finite arithmetics corresponding to a prime or a power of a prime where $p < 127$, and the appropriate holes in the corresponding gears were stopped up. This presents the problem to the machine, which, canvassing numbers at the rate of 300,000 a minute, can cover the above range for x in about two hours without attention. As a matter of fact, during the first test the power was automatically shut off in 12 seconds and the machine coasted to a stop.

Reversing the machine slowly and substituting the human eye for the photo-electric cell, the light was seen to shine through at $x = 56523$ according to the reading on the revolution counter. Substituting this value of x in the formula we obtain at once the number 309853160646773276521024, which is the square of 556644555032. Hence our problem is solved. Incidentally this leads to the factorization:

$$2^{79} - 1 = 2687 \cdot 20202973 \cdot 1113491139767.$$

D.H. Lehmer's Number Sieves

Richard Rubinstein

Richard Rubinstein, a human factors engineer at Digital Equipment Corporation and an active volunteer at The Computer Museum, compiled this article, based on his experience planning and supervising the Lehmer Number Sieves exhibit.

Dick Rubinstein (left) and Derrick Henry Lehmer (right) pause in front of Lehmer's Photoelectric Number Sieve after Lehmer's dedication of the exhibit, October 7, 1982.

Derrick Henry Lehmer is the son of a leading American number theorist, Derrick Norman Lehmer (1867-1938). D.H. Lehmer designed and built the number sieves shown in the accompanying photographs of the Museum's Number Sieve exhibit to further his own research in number theory. He presented the number sieves to the Computer Museum, and on October 7, 1982, he dedicated the exhibit with a lecture on the sieves. Videotapes of his lecture are in the Museum archives.

As a user of ENIAC, Dr. Lehmer was in charge of operations, maintenance, and much of the trouble shooting. Dr. Lehmer continues to use computers, such as the Cray 1 and ILLIAC IV, to support his work with number theory. He is professor of mathematics Emeritus at the University of California, Berkeley.

The number sieve idea dates back to the Greek Eratosthenes who lived in Alexandria about 230 B.C. His sieve provided a way to find prime numbers by removing composite numbers from a list of the positive integers.

The first mechanical realization of a sieve process was over 200 years ago, by Karl Hindenberg, a German, and Anton Felkel, an Austrian. They invented what is now called the stencil method. Using this technique, Felkel produced a compilation of the factors of the integers up to 408,000, published by the Austrian government in 1776. Few copies were sold, and those remaining were scrapped and used for making cartridges for the war against Turkey.

These sieves were specialized, useful only for finding primes and for finding the factors of composite integers. A more general approach, the strip method, used by A.M. Legendre in



1794, allowed searching for numbers with far broader properties, but was still a slow and error-prone manual technique. The strip method was the best available technique when D.H. Lehmer developed his first machine.

Dr. Lehmer built the first electro-mechanical number sieve in 1926. It used 19 bicycle chains, and performed a process similar to the strip method. The rotating chains simulate the effect of the shifting strips of paper, and have the major advantage that no upper limit of the search need be established at the outset. The machine can be left running indefinitely in search of numbers with the desired properties. In 1932, Lehmer built a far faster machine using 30 tangential gears, capable of perform-

ing 300,000 tests per minute. Later, he also built a sieve that used 16mm film, and another with vacuum tubes and delay lines. These machines did efficiently and inexpensively what no commercial calculating equipment then available could do at all.

This small sieve, employing 16mm film as the computing elements, was built as a complement to the large photoelectric machine. It was used for relatively short problems, and performed about 3000 tests per minute. Easier to set up than the photoelectric model, it could be supplied with as many as 18 film loops.



These stencils were used by D.N. Lehmer (D.H. Lehmer's father) to produce a table of factors up to 10 million. A great deal of kitchen-table work was performed by the whole Lehmer family in order to create these card-board pieces. Number theory seems to be a family activity with the Lehmers. Dr. Lehmer is now working with his grandson on a new machine using integrated circuit technology.

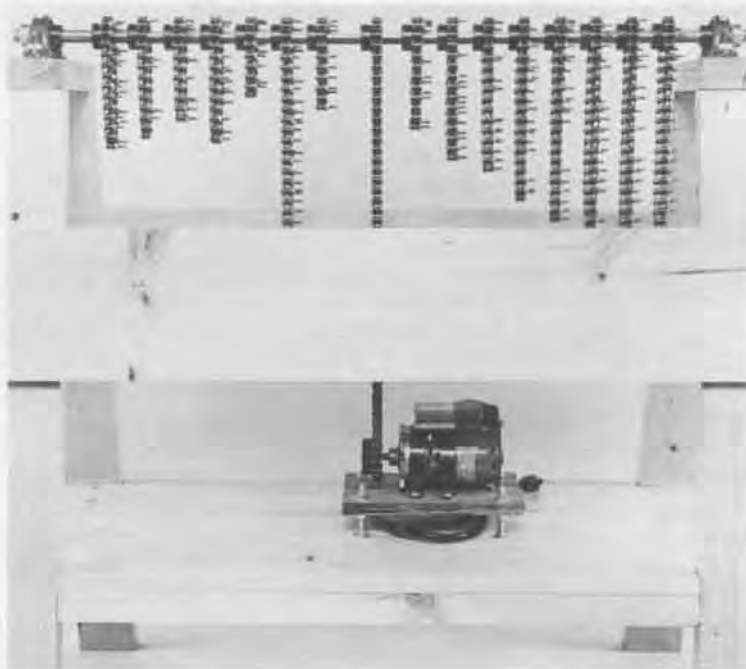

The Bicycle Chain Sieve, built in 1926 but later destroyed, is being replicated at the Computer Museum by Roberto Canepa, Andrew Kristoffy and Richard Rubinstein. This photograph shows the Museum's working model before the installation of micro-switches and a counter. The original 19-chain machine could perform 3000 tests per minute. It was used to factor the number:

9999000099990001

which is a factor of $10^{20} + 1$. The machine ran for about two hours, finding the solution:

1676321 • 5964848081

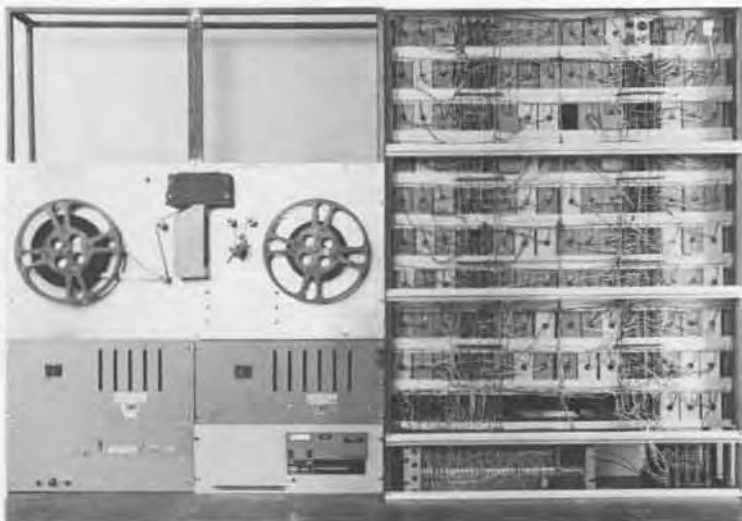

Constructed in 1966 as an unsponsored educational project of the Departments of Mathematics and Electrical Engineering at the University of California, Berkeley, the Delay Line Number Sieve performed 1 million tests per second. Navy surplus delay lines store the acceptable remainders for each modulus and circulate them synchronously. The machine has an idle mode in which all of the delay lines are connected in series and the data recirculated, so that the machine may be "stopped" and loaded.

"In competition with the IBM 7094 [it] makes a good showing, especially on economic grounds. It is roughly 10 times faster than the 7094, and costs about 2 cents an hour to operate."

D.H. Lehmer

Inside "The Soul of a New Machine"

Tracy Kidder and Tom West

Tracy Kidder (left) and Tom West (right) discuss The Soul of the New Machine during the Museum's Bits and Bites series.

Tom West: I think it's probably important to point out that Tracy and I have never done this before . . . and will probably never do it again! I am still doing computers and Tracy is still writing books. Neither of us has yet become P.R. junkies, but that may change after looking at such a large group of people who seem to think we have something to say.

Tracy Kidder: We would like to find out what you are interested in and try to answer your questions.

Q: How did you two first get together? Did you start writing at the time the project was started?

Kidder: About six years before I started, I had been a journalist writing for the *Atlantic Monthly*. I went in to my editor one day because I had nothing to do and asked him what I should do next. He said "Look into computers." I asked where I should start and he told me to go see West, whom he knew. So I did and then one thing led to another.

West: It was a little more complex than that. Tracy decided that he was going to write "The Book" about all computers. He went to the library and found that there had already been many stories written about the whole world of computers. Then it was going to be the whole world of mini-computers, which I suspect even today is too big a story to tell. It kept narrowing and narrowing, until, rather accidentally it became focused on a single machine.

Q: What was it like for you, as someone who is used to working with machines in a crisis situation, to be shadowed by a person with a notebook?

West: There are some real advantages to having a writer on a project. Tracy was about the best early warning system you could imagine. I would suggest that every program manager hire some guy from the street, teach him how to write on steno pads and have him walk around listening to people. The young



engineers walk around thinking that this must be an incredibly important program because somebody is writing about it. One disadvantage is that you could wind up with the most well-recorded failure in history.

Just Tracy looking at the thing actually changes the way it works. There is all this uncertainty involved. It's not the way it would work under normal circumstances, it has been perturbed. It is a little disarming to wake up in the morning, go down to breakfast and find Tracy Kidder interviewing your wife and two daughters with a steno pad.

Kidder: Most good journalists, and I certainly aspire to be one, think of themselves as good anthropologists who come in to observe the customs of the natives and don't want to change those customs in the process. Just the fact that you are there changes things. But, if you are never there at breakfast then you would never know what happens at breakfast.

Q: What sort of reaction did you get from Data General and from people in the book, after the book came out?

West: For me, it was like three years of psychoanalysis embedded in about twenty-four hours. I hadn't read the book before Tracy went to the printers with it and I don't think many of the other people had either. It was a shock then, to all of a sudden see a whole piece of your life in print, a piece that maybe you would have chosen to rewrite very carefully.

I don't think Data General was certain, even after reading the book, what the public reaction was going to be. It was a fairly accurate representation of what they do every day for a living. And I don't think that the story is unique. Otherwise, why do so many people read the book? Why do so many people buy the book and send it home to Mom to explain what they do? And why do they give it to their girl friends to explain that this is the reason they are not home until eleven o'clock at night? The general answer is that the everyday life of designing computers had been pretty opaque.

But from my point of view the reviewers tell you what you are supposed to think about the character.

Kidder: That's right, you have been called Captain Ahab, The Prince of Darkness, Machiavelli, Tom Swift . . .

West: Gatsby and Horatio Alger. It's been kind of eerie.

Q: The paperback book says it is soon to be made into a major motion picture. What is exciting to the lay person about high technology?

Kidder: I think this is kind of fun, frankly. Columbia wanted to turn this into a movie, one way or another. As to why they find it interesting, I don't know. I found the story interesting and I rate as a lay person. At one time during my research, Data General had some understandable fears about trade secrets. West pointed out in a rather sardonic way that I would never learn enough to be able to convey a trade secret.

West: When people ask why D.G. allowed a Pulitzer Prize winning book to be written about their machine, that is not what they agreed to. A guy was going to write a little piece about a couple of guys sitting down in a lab sort of dreaming up their own thing. Even at printing time there was really no way of knowing that there was quite so much interest in Tracy's book.

Q: What are some of the advantages of a closed management style versus a more open one?

West: In support of this sort of closed management style, I knew more about what was going on in every single one of those organizations than any manager at that level in most companies does. It's not a question of not having the information, it's a question of not having the style.

If somebody walks into your office after five minutes of staring at a sheet of paper and asks: "Should we make this register sixteen bits wide or thirty-two bits wide?" you know the answer to this question if you have been through it over and over and over again. So you can tell him the answer, and he goes back and puts it in. Then he sits around for another five minutes before coming back with the next question. In some sense that is sort of what happens.

If you can send him back to his office and he thinks a little while longer, ten minutes, fifteen minutes, or a half an hour, and then he gets a little scared because he's got to have the right answer by the time he goes back in again, you extend his span of attention before he is finally ready to go and scream for help.

It seems to me that that is one of the most valuable lessons that you can

teach a kid who is coming into this business right out of school. A span of attention of five minutes or even a half an hour is not really going to do it. There are some problems that only yield after three hours of just staring at them. I'm sure all of those who have been doing design work have seen exactly that same thing happen. It is the ability not to give up even after two hours of trying to stare something down. Part of that is what is embedded in that whole style of trying to make the easy answers difficult to get.

Q: It is very clear at the end of the book that you couldn't keep a good team together, but it is also sort of sad that so many of them end up leaving Data General.

West: At the end of this program, an awful lot of people, not only left the program, but also left Data General. This is not a totally anomalous phenomenon to D.G. People don't leave projects in the middle, they leave them at the end, with an incredible postpartum depression at the end of something that they poured so much adrenalin into. They go home and with more time on their hands. They begin to ask themselves why the heck they ever did it in the first place and would they ever be willing to do it again. If the answer is yes, then what are the odds of their doing it successfully again? Is it a coin toss, fifty-fifty each time, or do the odds keep piling up against you?

I read in Time Magazine that statistically I'm burned out and washed up at forty-three. I think there is going to be not only a shortage of engineers in the next ten years but a shortage of engineering managers with enough street sense to be able to manage all the college graduates who are graduating with all kinds of notions about things that can be done but quite possibly shouldn't be done. Just like all these people who are putting 68000s on a board and calling it a computer. There is going to be a great need for people to be able to see the way technology is going and be able to manage these people coming out of school.

In this machine we had a straightforward design. We were highly leveraged on PALs because it provided quite a bit of logic compression. Almost everyone drew out these PALs, except the guy who was designing the system cache. He was doing it all on four by five file cards. Every week or so I'd ask him how he was coming on his design. He'd show me this big deck of file cards with Boolean equations written on them and a whole room full of Karnaugh maps and

things to try to reduce these down to something that made sense. There was no way of telling where the guy was. Design review time was coming and all the managers were getting anxious. The big deck of cards was still there, and he was still worrying about the various mapping things that he'd learned in college. We really came perilously close to firing that guy. But finally when the design review day came, it was a deck of cards with a well-defined set of Boolean expressions for each one of those PALs. We used one hundred and sixty of them in the machine and about forty of them on the system cache. He built the thing, and it worked the first time. At that stage of the game I said to myself; thank God I didn't fire him.

Q: Would you attribute the intimidation some of your subordinates felt toward you to their inexperience?

West: In the first place, I would sure hate to defend what I did four years ago. At some level in the organization you expect to have people who are going to fight back, regardless of what the issue is, if they feel strongly about it. If they don't feel strongly about it, then they had better go away and do it your way.

Q: The book mentions the fun part, the engineers doing the design, but I don't remember hearing about the paper work and bureaucracy, meetings etc. Did you find some way around that?

Kidder: You know the old joke about the bum who is looking for his quarter under the street light, even though he dropped it half a mile away because the light is better. This book doesn't take on, in any detail, the software part of the project which is at least half. There were some things that I saw more of than others. I was also able to drag a certain amount of that information out of Tom. Then one day I said to Tom: "I don't know much about what you've been up to lately," and Tom said, "Oh you noticed."

I always thought that the salient characteristic of this team, which I thought was charming, was that no one ever seemed to take pert charts at all seriously. A nucleus had built computers before and they knew what was required. They knew, I think, that what was required could simply not be embodied in a pert chart.

Q: If you could do this over again, would you fight harder for a mode bit?

West: No, quite the contrary. In hindsight I thought that was a really spectacular decision. Tracy said half the work may have been software where I would guess eighty percent of the work

was software. Without the mode bit we could drop sixteen bit programs on that machine and run them. For a long period of time that was exactly what we were doing. We also had three or four hundred thousand lines of diagnostic code, all of which would have had to be rewritten. So for the time being, having that absolute compatability was the only thing that could get it there on time.

The point is that the machine doesn't have a golden moment of when you all of a sudden stop implementing the mode bit and then move on to a different identity. Mode bits tend to increase in a geometric fashion, and I've seen a lot of machine families that are now going into their two-to-the-sixth mode bit. Intel is going to solve all their incompatibility problems at the chip level with mode bits and it is going to go to huge numbers, I think.

Q: I wonder if you could say something about Ed DeCastro's involvement. The novel makes it seem like he was very rarely checking on the project.

West: That is one of the most difficult questions to answer because once again I think most of the people who were working on the project itself would assume that I had no visibility, barricading myself in my office. Mr. DeCastro is more than likely to let something go with benign neglect, assuming that local management would find a way to solve its problems. He was certainly not involved on a daily or weekly or even monthly basis.

Q: What about Carl Carmen, who was the vice-president of engineering at that time?

West: He was involved during the program, in making sure that the environmental issues were taken care of, that the PC shop worked at the right speed and that things didn't get lost in the mill. He also barricaded the team against the rest of the organization.

Q: Since you weren't able to tell us much about software, those of us who are in software felt a little cheated. Could you tell us what the organization of the software development's side was?

West: When Tracy talked about looking under the street light for the quarter it is because hardware tends to be a lot easier to see, it has a lot more of a visual effect than writing code does.

The reason for having the sixteen bit identity in the machine initially was because we didn't believe that we were going to have any software at all. There was a guy who decided that he could take our existing sixteen bit operating

system and by taking it module by module convert it and run it initially in just a couple of the rings with only a couple of the features, and then incrementally get there over a period of a year and a half. He put together a team of twenty volunteers all signing up for a kamikaze mission because nobody really believed that it could be done. Then he decided that we were going to have the software to announce at the same time that we had the hardware to announce. All we had planned to announce was thirty-two bit hardware, which would get some pressure off our back and point to futures. He managed to do it. The reason that he managed to do it was that he didn't decide okay, I've got a clean sheet of paper and I'm going to develop an O.S. all the way from the ground up, based on the first principles of computer science. The relationship was quite close. In the final analysis, the only thing we really had to de-bug in the thirty-two bit part of the machine was the operating system which had already been run through thirty-two bit simulators. At that stage of the game we were using system software to de-bug the hardware.

Q: What happened to the competing design?

West: The competing design is still alive. It's always difficult to know the answer to "What if?". It would be naive to suppose that D.G. was only working on extensions to the Eagle family of machines. It would also be naive to assume that we are just pragmatically going to follow technology and wander along incrementing the existing product line. The question is when, not whether.

Q: The book mentions a saying in Mr. West's office that anything worth doing is not necessarily worth doing well or something along those lines.

Kidder: One of the things that I began to learn about engineers is that they are aesthetes as much as they pretend to be something else. I've seen this most vividly in the intersection of engineers and non-computer scientists. The engineer talks about technical symmetry and the scientist says I just want something that works. I think that that was what that piece of cryptic puzzling advice was. How did it go? Not everything worth doing is worth doing well.

West: I am very comfortable with that notion. I suspect that there are more people who fail in our industry because they try to do it perfectly, as opposed to doing it on time and on cost.

Q: What are you doing now, respec-

tively, and secondly, are you (Tracy) sick and tired of computers?

West: We are still basically doing the same thing—designing machines—at Data General. The book portrays people leaving, which was true at the time Tracy had to go to press, but since that time a large number of people did stay. All those people have formed a nucleus to build multiple different machines, going in different directions, they build bigger ones, smaller ones, faster and cheaper ones.

Kidder: I'm digging out from under. I'm writing some articles about atmospheric research. To be honest, I'm a little tired of my book. I put it on my shelf and won't read it again for years. I think I know what's wrong with it. In some sense, writing a book is like building a computer. There are rewards but one of the main ones is that Sisyphean one that if you do one you get to do another. So, I have an opportunity now to write a better one.

Extracted from a talk by Tracy Kidder, author of The Soul of a New Machine and Tom West, the chief designer of the machine, Data General's Eagle, in the Museum's "Bits and Bites" series, given October 17th, 1982.

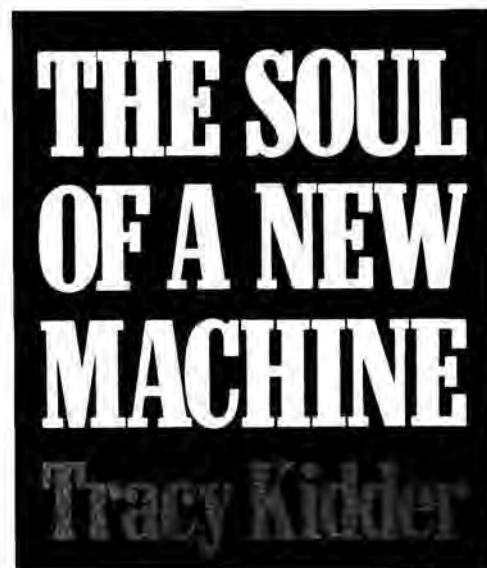

Tracy Kidder autographed copies of The Soul of the New Machine for the Museum. Remaining copies of the autographed copy are available for \$18.00 (including shipping) from the Museum store.

Recollections of the Watson Scientific Laboratory, 1945–1950

Herbert Grosch

The heroes of this story are Thomas Watson Sr. and Wallace Eckert. Tom Watson Sr., when I first met him, was in his seventies. In the 20's, 30's and 40's, he supported what he thought of as scientific research, but what we call applied research. At that time, this kind of support was uncommon for even the most advanced American industries.

Wallace Eckert's prime life interest was the theory of the motion of the moon. Astronomy provided one of the earliest groups of people who had substantial problems which had to be solved with computation regardless of the form, whether it be pencil and paper, logarithm tables, or with the most advanced modern solid-state computing devices. In the thirties, a major problem was that crossing the Pacific required the measurement of both longitude and latitude. The chronometers were inaccurate and a very accurate clock

was needed. Many many years ago the motion of the moon among the stars was suggested as a clock. As a consequence, a great effort was put on the determination of the proper position of the moon. One of Babbage's interests was in building astronomical tables helpful for navigation. Even today, people who are doing algebra on computers, often use the enormously complex and lengthy formulas of the literal lunar theory as an example.

Eckert discovered a series of articles by L.J. Comrie, a New Zealander who by that time had penetrated the scientific establishment in England sufficiently to become the Director of the Nautical Almanac office at the Royal Greenwich Observatory. These articles explained how Comrie had rented Hollerith machines from the British Tabulating Machine Company and had done the calculation of the positions of the moon for every hour or every six hours or something for hundreds and hundreds of years on a mass production all-parallel basis.

Inspired by this, Eckert, with the help of the American Astronomical Society of which he was a junior member and Columbia University where Thomas Watson Sr. was a Trustee, approached the IBM Corporation, a less than one-hundred million dollar business. They donated some special equipment which he installed and called it The Thomas J. Watson Astronomical Computing Bureau which flourished in the late years of the thirties.

Then the War threatened. The U.S. Naval Observatory had to manufacture a new publication called the Air Almanac for the use of navigators crossing the Atlantic by air, especially for bomber navigation, when the skies were clear and bubble sextant observations and so on were possible. They had run out of old-fashioned people who could do this with paper and pencil and logarithm tables. Wallace Eckert's war work was the real McCoy—carrying out very complicated calculations, the sort that



This famous photograph of Thomas Watson Sr. hung over the fireplace in the Watson Laboratory at Columbia University for which he furnished the money and a large part of the inspiration.



Wallace Eckert



In 1945, IBM remodeled this fraternity house and donated it to Columbia University for the Watson Laboratory. The first concept of the SSEC was formulated in this building and the group that eventually built the NORC (Naval Ordnance Research Calculator) worked on the upper floors and in the basement.

strained the professional astronomer. Done, however, in parallel so you didn't have the problem of a complex sequence, but doing a single simple operation to hundreds or thousands of pieces of data at one time and then moving on. With methods he developed for automatic proof-reading, he was able to produce the Air Almanac. Since that time literally millions and millions of characters have been printed by the calculations of such equipment, printed by his automatic printing machine, and proof-read by automatic devices without one single error ever having been detected.

In 1941, I became an optical designer which involved lots and lots of calculations on Monroes and Fridens. Then, in the early spring of 1945, an announcement in *Science* stated that Thomas Watson Sr. had called Wallace Eckert back from Washington and had asked him to establish a new scientific computing laboratory at Columbia University. Before he left Washington, I wrote Wallace asking if I could come around in the evenings and try out some of my ideas on optical design on his nice new shiny IBM machines. One of the incentives for beginning the laboratory was that the computational facilities at Los Alamos had run out of capacity. Wallace accepted the charge of setting up a shop of IBM machines at Columbia with the first task to supplement the Los Alamos calculations on the Alamogordo burst. While I only hoped for an invitation to maybe around one night a week, instead a little man from the Manhattan Project showed up at my optical company and took me away. I said, "You know you can't do that, there is no such thing as a civilian draft." He essentially said, "Tell that to General Grove." The next thing I knew I was an IBM employee. In the rush they forgot to pass me through IBM headquarters. As a result, although I received an identification card and all that, nobody had paused to tell me that you could not have hair on your face and work for IBM. So I was not only a very early scientific punch card operator and supervisor but I also was the first bearded sport-coated IBM employee.

1946. Boom. ENIAC. For the first time IBM felt threatened by a development that they had not really foreseen or understood. One of the responses to the ENIAC announcement was the mass production (mass being about twenty units) of the 603 calculating punch operating at around six thousand cards an

hour while its electro-mechanical competitors did six hundred. IBM had produced it out of their own patents, their own Eccles-Jordan flip-flops and so forth, originating primarily with a gentleman by the name of Halsey Dickinson. But, this card calculator was not enough for either Eckert or Thomas Watson Sr. who was incensed that someone would produce something that he didn't know about and hadn't sponsored.

A group of people were brought together to write the specifications for a gigantic new machine, the SSEC. With almost no electronic gear available on the market, the arithmetic units were designed around the standard 25L6 radio vacuum tubes. The design of the SSEC went ahead day and night, seven days a week at the IBM engineering laboratory in Endicott. Along with the electronics, a complete panoply of peripheral equipment was designed: high speed card readers, auxiliary tape punches, card punches, fancy console, storage devices, and a major table look up unit in contrast to the setting switches on ENIAC's function table panel.

The whole thing was to be installed in beautiful quarters in the IBM world headquarters at the corner of Madison Avenue and 57th Street, since torn down. Since no sizable ground floor space was available, they bought out a store called the French Bootery around the corner on 57th Street. They tore out the shoe store shelving and put power supplies with a gigantic air-conditioning unit in the basement. The equivalent of false floors was created by a raised floor with the enormous amount of electronic cabling under it. The machine was put together at Endicott, ran, taken apart, and moved to New York City.

On Mr. Watson's final inspection about two or three days before the opening ceremony, he was disturbed by the fact that there were large columns marching down the center of the room. He said, "Everything is lovely, you gentlemen have done a beautiful job but I think we should remove those columns." Unfortunately, they held the building up. Nevertheless, the four-color brochure which had been printed for opening day was recalled and a two color sepia print center-fold inserted showing the machine room minus its columns.

After the dedication, Thomas Watson Sr. said, "It's wonderful how these people out at Endicott and these people in New York have slaved over this ma-

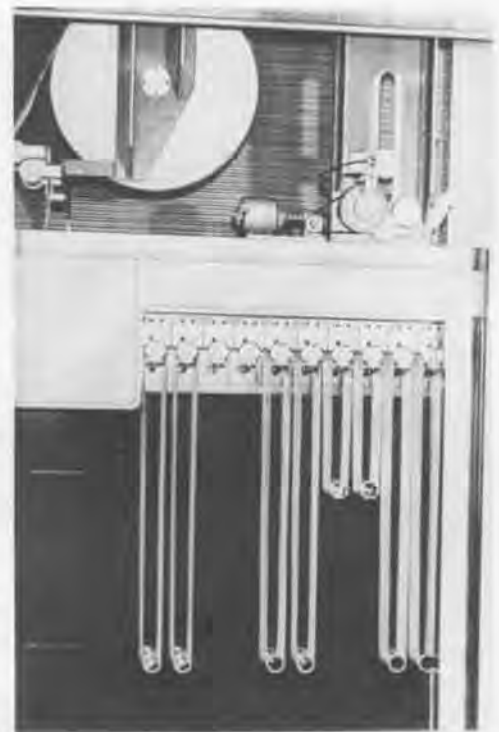

The SSEC tape drive consisted of a four hundred pound reel of card stock which had to be lifted with a chain hoist. It is sliced, unlike the average roll of card stock, to the length of the punch card rather than to the width. In other words, it is eighty columns wide. It passes through a punch unit in the square box at the upper left and is punched with two round sprocket holes and up to seventy-eight conventional IBM rectangular holes. One line of this punching constitutes a line of instructions or data. It could then go to as many as desired of the succeeding ten stations or loops used as sub-routines. Sixteen feet high racks of wire contact relays (equivalent of what we would call core or central memory) were behind the scenes. The electronic memory in the arithmetic unit was only a few words, since the tapes were used as input and long-term memory devices.



The SSEC used conventional IBM 405 tabulators rehoused with the tape slugs turned upside down, and the wires crossed so as to make it work out of the back instead of the front for the sake of appearance. The 12,000 inch and a quarter diameter 25L6 boggles out of which the arithmetic circuits were made can be seen in the back of the photo.

This Lake wire contact relay was made in 4's, 6's and 10's. The whole unit was about two inches high. Because of the nature of the armature, a little thin plated wire, they were nearly as fast as the telephone relays.

chine for the last year. Their wives have let them work all hours. They have been diligent and successful. We will celebrate by having a weekend at the Waldorf." On two days notice telegrams went out to all of the senior people that had shared this activity, inviting them and their wives to come to an old-fashioned family get-together at the Waldorf. That is a somewhat large family. Rumor had it that the Waldorf was chosen not only because Mr. Watson liked it very much, but because all bar bills were charged as restaurant. At the luncheon, the old man got up and told us how he loved us, how wonderfully we had behaved, and how we were all part of the IBM family. It was a fantastic exhibition of the kind of excitement that Watson, then in his mid-seventies, could generate.

The Lab's decoration was in my hands and I worked with Mary Noble Smith, the curator of fine arts, who helped me furnish the place with the IBM ceramics and paintings. The ceramics came from a program "the old boy" had sponsored at Syracuse University

before the war. He liked it so much that he bought it all and put it in a warehouse where we retrieved some pieces. The old man objected to my choice of French Impressionist paintings in the lobby and remarked that there should be pictures of telescopes and so forth. The next day Mary Noble said, "What are we going to do about those photographs that Mr. Watson wanted?" I said that we weren't going to do anything about it. When they closed the building to move to 115th Street, those paintings were still on the wall. Wallace Eckert was asked for his opinion on paintings of great American scientists commissioned by IBM. Wallace who was a Yale man liked Willard Gibbs, so we hung Willard in the library. Mary Noble came down to me wringing her hands saying, "I don't understand it, we wanted you to have 5 or 6 at least."

I asked to see the list and said, "We will take Ben Franklin."

"But Dr. Grosch," she objected.

I said, "Ben was sort of an amateur natural philosopher, lightning and all that business. But the rest of these guys

like the Wright brothers and Edison are inventors, we don't want them here in the Watson Lab."

She said, "I don't understand the difference. What do you mean by a scientist?"

About six weeks later the art van drove up and they delivered a portrait of Newton which I hung in the library with great pride. When I saw her again I asked her where she had found the portrait. She said; "I had it painted for you."

The Lab's electronics group was very special. Rex Seeber was recruited from Aiken's Harvard Mark I with the experience of running a big machine which practically no one else in the world had at that time. He was invaluable as the man who lived downtown with the SSEC in its plate glass and stainless steel palace and turned out very useful work. Eckert was well aware of the fact that IBM did not have modern pulse technology at its disposal. What was needed was to go to the more modern mega-hertz kind of technology which was available in large quantity

The Pioneer Computers

	Start up	Completion	Program	Word length
IBM SSEC 57th Street at Madison, New York City	10/46	1/48	78 hole punched tape (IBM card stock), punched cards, plugboards.	20 decimal digits (19 + sign) double precision table lookup 14 x 14 arithmetic



at Bell Labs and M.I.T. With the help of I.I. Robie who was Eckert's close friend from his days as an astronomy professor, Eckert hired two young and one mature electronics engineers. They arrived simultaneously and put my nose out of joint because they knew an awful lot of things I hadn't even dreamed of yet. Byhavens built the NORC and was interested from the beginning in doing that kind of activity. John Lenz was more concerned with a tool for individuals and less with building a gigantic machine for number crunching. He built a smaller machine or the pieces of a smaller machine which led toward the IBM 610. Robert Walker, who was the more mature man, first continued to play with analog circuitry and then ended up interested in a simultaneous equation solver.

I mention this because one of his visitors was Clifford Berry, the co-worker of Atanasoff. Berry was interested in infra-red spectroscopy and had published an article in *The Journal of Applied Physics* on a knob-twiddling analog simultaneous equation solver.

Walker wrote to him, had him brought in and they talked with Francis Murphy of the Columbia Math Department and others about how to build a machine of this sort at the Watson Laboratory. By the time it was a useful tool, the technology had moved on towards digital computers. With a 604 you could solve ten equations and ten unknowns to six or eight figures in a reasonable amount of time. In contrast, Walker's analog device took quite a long time to twiddle all the knobs and was less accurate.

The practical computer shop was used by people in chemistry and geophysics at Columbia, by Wallace Eckert, L.H. Thomas, and myself for our research, and for work for General Electric on unclassified nuclear energy and steam turbine design. We helped install the 604's, and watched the CPC develop. We saw people like George Finn, Bill Woodbury and Rex Rice from the aerospace industry demand that IBM build a more sophisticated machine for mass production. Ed Teller especially came to us for calculations in partial differential equations of partial integral differential

equations which were tougher than what we had done on the punch card machines. With those we used special relay calculators built for us by Hans Peter Loon who later became head of The Information Society of America. He was a great guy at whomping up special machines using those Lake wire contact relays and his own design methods for survey calculations, cryptography or whatever was needed.

As word spread that a machine was becoming available at the consulting service at Columbia, people began to drift in and say, "Hey, what should I do to start doing this?" In 1948 when I ran the conference at Endicott we were hard put to come up with fifty or sixty people who really wanted to do advanced technical calculation on punch card machines. When the CPC's began to come out and word of the Defense Calculator began to spread there began to be hundreds of installations that became interested in doing it with thousands of people. A.C.M. had started in 1947, the IEEE and its predecessor societies began to talk about applications and not just about the details of construction. There was a time around 1950 when computing went from a small coterie of enthusiasts to being commercially practical. No mass production had occurred; the UNIVAC 1's had not yet been produced; the 701's were still two or three years from major delivery; but the scent was in the air. It was obvious that there were going to be large numbers of sophisticated number crunchers which were going to need trained people, professional operators and software artists. And they were going to be used not only in science and engineering where they were already popular but in business as well.

Yet Wallace always wanted to do astronomy. One of the things we built at the Watson Laboratory was an automatic measuring engine to measure gigantic photographs of the stars. A punch card went in, the machine made a rough setting, a photo-cell made a more accu-

Memory size (words)	Add time	Memory type	I/O	Technology	Floor space est. sq. ft.
8 words electronic, 150 words relay, 20000 words tape (including 5000 lines of table lookup)	0.3 ms	relays, wide tape	wide tape, punched cards, line printers	12500 vacuum tubes 21400 relays 40000 pluggable connections	3050 (special room)

rate setting and the punch recorded it on the initial card. It sped up the process of astronomical measurement by a factor of five or six. If he had wanted to abandon astronomy and become a computer man, I'm sure he would have been a much better known figure. His contributions were enormous but they were disguised by the fact that he really did them in order to do better astronomy. That helped us all, helped astronomy, but it was a direction that did not please IBM so much.

The Watson Lab was very valuable as a consulting service and as a point of contact between IBM and academia. As a part of astronomical research it was unequalled. As a signal that Thomas Watson Sr. who furnished the money and much of the incentive for this was committing his rather small company to a scientific and engineering enterprise that was unfamiliar to it, it was very significant. One of the things that we did was to teach courses in machine operation and numerical analysis. I think that the main thing that it did was to bring a whole bunch of youngsters into the trade. Because of its location at a University, because we offered courses, because we tried to get young people from customer installations to come and take special work on numerical analysis and punch card machine operation, we passed several hundred bright new people through that shop before it moved to physical research. In the long run, the fact that we had Backus, McClelland, and people like that did more good out in the world than just telling GE that yes, they ought to get a defense calculator.

Extracted from a Museum Lecture given by Dr. Grosch on October 22, 1982. It provides a complementary, personal view of the Watson Laboratory at the time of the SSEC to the two articles appearing in the October 1982 Annals of the History of Computing: "The SSEC in Historical Perspective" by Charles J. Bashe and "A Large-Scale, General-Purpose Electronic Digital Calculator—The SSEC" by John C. McPherson, Frank E. Hamilton, and Robert R. Seeber, Jr.

As a result of this lecture and the two articles, the Museum's Pioneer Computer Timeline is being revised to include the SSEC: the first machine to combine electronic computation with a stored program and capable of operating on its own instructions as data.



NORC was the pinnacle of achievement of the old Watson Laboratory. Although it wasn't delivered until 1953 or so, the work had gone on from 1948. It was also, in a sense, the culmination of the decimal machine.

Four of the staff from the Watson Lab travelled to the Computer Museum to hear Dr. Grosch's lecture and visit with Dr. Grosch (second from right). Dr. L.H. Thomas (left) and his wife Naomi drove from South Carolina, William McClelland (second from left) and Donald Pendrey (right) arrived from Connecticut, and John and Alice Lentz (not pictured) travelled from Chappaqua, New York.



Field Trip to North Bay

Gordon Bell

The high point of the first Computer Museum members' field trip was the visit to the SAGE AN/FSQ-7 computer prior to its decommissioning after operating "around-the-clock" since 1962. The "Q-7", once known as Whirlwind II, grew out of the Whirlwind project at MIT and became the prototype for the nation's air defense systems. In turn, this technology formed the basis of modern air traffic control!

Seventeen museum members made the trip to North Bay, Canada and the National Museum of Science and Technology in Ottawa. The group included Bob Crago from IBM, one of the key designers; Kent Redmond and Tom Smith, historians writing the SAGE story; Henry Tropp, who is writing an article for the Annals of the History of Computing; and Richard Solomon who photographed and videotaped the Q-7 as part of an MIT Project on the History of Computing. We left Friday noon, 8 October, from Bedford, Mass. for North Bay, arrived and visited the "hole" where we were completely briefed by members of the staff and original installation team, had dinner with the Canadian Air Force leaders, including the Commanding NORAD General (U.S.), flew on to Ottawa where we spent the night prior to visiting the National Museum of Science and Technology and returned Saturday afternoon.

The Q-7

Bob Everett's paper on the SAGE computer was published in '57, and the machine was operational in Canada in '62. The machine created many patents as by-products, including perhaps the first associative store (using a drum). The machine is duplexed with a warm standby (I mean warm since the duplexed machine uses about 1 Megawatt of power to heat 55,000 tubes, 175,000 diodes and 13,000 transistors in 7,000 plug-ins!). The 6 microsecond, 32-bit word machine has $4 \times 64K \times 32$ -bit core memories and about the same memory in twelve 10.7" diameter, 2900 rpm drums, 6 of which are for secondary memory. There is no use of interrupts and I/O is done in an elegant fashion by loading/unloading parallel tracks of the drums with the external world completely in parallel with computing. That is, the I/O state becomes part of the computer's memory state. A single I/O



channel is then used to move a drum track to and from the primary core memory.

The main I/O is a scan and height radar that tracks targets and finds their altitude. The operator's radar consoles plot the terrain and targets according to operator switch requests. The computer sends information to be plotted on 20" round Hughes Charactron (vector and alpha gun) tubes or displayed on small alphanumeric storage tubes for supplementary information. Communication lines connect neighboring air defense sectors and the overall command. The operating system of 1 Mword is stored on 728 tape drives and the drums.

The computer logic is stored in many open bays 15' to 30' long, each of which has a bay of voltage marginal check switches on the left side, followed by up to a maximum of 15 panels. The vertical panels are about 7' high by 2' wide and hold about 20 plug-in logic units. The separate right and left half of the arithmetic units are about 30' each or about 2' per bit. Two sets of the AMD 2901 Four-bit Microprocessor Slice would be an overkill for this 32 bit function today. The machine does vector (of length 2) arithmetic to handle the co-ordinate operations. The room with one cpu, drum and memory is about 50' x 150', and the room with two cpu consoles, tapes and card I/O printer is about 25' x 50'. The several dozen radar consoles are in a very large room.

Underground Site

The enormity of the machine was dwarfed by the underground building which encloses it. The building hollowed out of stone by hardrock miners is 600' beneath the surface, and connected

The AN/FSQ-7 control room has been an integral part of the SAGE air defense system from 1962 until powering down in the spring of 1983.

These are only a few of the 55,000 vacuum tubes in replacable plug-in modules that support the SAGE AN/FSQ-7 at North Bay, Canada.

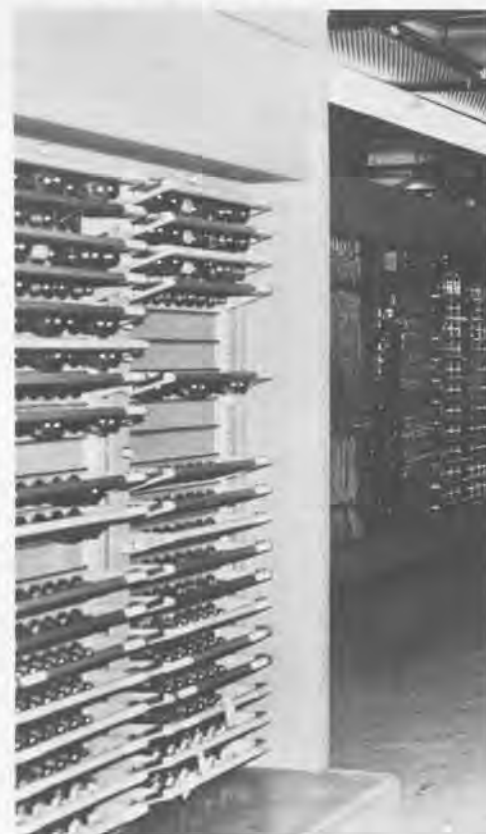

by a 6000' tunnel which can be sealed off in seconds if there are very large, atmospheric disturbances. The building is about 150,000 square feet and has 10 standby 100 Kw generators and an air conditioner that can operate closed loop into an underground pond.

Cost and Reliability

The machine and software cost about \$25M in 1962 and the site about \$25M. The facility costs several million to operate per year, including about \$1M to IBM. Three people are needed to maintain the software. Initially, one hundred people were used to install the machine and set up its maintenance. When you count the radar, planes, etc. and operational costs, the computer cost is almost an incidental.

The reliability is fantastic! With ONE COMPUTER, AVAILABILITY IS 99.83% and with DUPLEX OPERATION, AVAILABILITY IS 99.97%! Having wondered why such an obsolete computer would be still used, it was clear: the reliability and the overwhelming fixed costs for radar, airplanes, etc. Marginal checking and incredibly conservative design were the key. Each week they regularly replace 300 tubes and an additional 5 tubes that are showing signs of deterioration.

Even though the program is about 1 Mword, written in assembly language and Jovial, the key here is the aging and the fact that the program is NOT interrupt driven. The program simply cycles through the job queue every few seconds in a round robin fashion. This is an excellent example of superb software engineering with an incredibly simple overall structure since it is non-parallel, all the bugs that an interrupt driven system would have had are avoided. Users identify overload by the lengthened cycle time. The high reliability demonstrates learning curves as applied to reliability. This obvious notion just occurred to me: since all the software I see is always changing, it doesn't reach ultra-high reliability.

Bottom Line

I doubt if any of the existing personal computers that operate today will either operate or be found in 25 years, simply because technology will have changed so much in performance and reliability as to make them uneconomical at the personal level. How many of us still repair and use our 10 year old HP35's? Furthermore, all the floppies will have worn out and we'll be glad to be rid of them.

Gordon Bell,



October 7th, Charles Bachman, Chairman of the Museum's executive committee, Kitty Selfridge, Chairman of the Museum's membership association, talking with Mike Woodger of the National Physical Laboratory after the lecture by Derrick Lehmer.



October 7th, Derrick Lehmer and Richard Clippinger reminisce about their days using the ENIAC.

The Founders Program

During the initial two-year period of the Museum, until June 10, 1984, the Founders Program is in effect. The purpose is to build a strong foundation for The Computer Museum. This provides participants with a unique opportunity to help The Computer Museum become established as an industry-wide Museum that will have enough support to continue its efforts to preserve the history of information processing.

New Individual Founders

We are pleased to announce that our list of individual founders has now grown to one hundred and seventy-six individuals who have contributed \$250 or more to The Computer Museum.

John Atanasoff
 Harut Barsamian
 G.C. Belden
 James and Roberta Bell
 David H. Brandin
 Richard A. Brockelman
 Roger C. Cady
 Philip and Betsey Caldwell
 Harold Cohen
 Charles W. Conn
 Amos R. L. Deacon, Jr.
 William R. Demmer
 Lloyd I. Dickman
 Patrick M. Donini
 J. Alvin Dru'yor
 Sanford H. Duryee
 David B. Edwards
 Dan L. Eisner

John H. Esbin
 Edward Alvin Feustel
 Bruce Gilchrist
 Philip Goebel
 Bernard M. Gordon
 Richard H. Gumpertz
 W. M. Hall
 Lewis H. Halprin
 J. Scott Hamilton
 Robert B. Hoffman
 Harry Huskey
 Richard I. Hustvedt
 Robert A. Iannucci
 John Allen Jones
 David C. Knoll
 Andy Knowles
 Alan Kotok
 Kaneyuki Kurokawa
 Robert C. Lieberman
 William F. Luebbert
 Tsugio Makimoto
 Franklin N. Mann
 Patrick J. McGovern
 Matthew Miao
 Harold T. Miller
 Gordon E. Moore
 John Morrissey
 Albert E. Mullin, Jr.
 David Murphy
 Lee J. Neal
 J. Eric Pollack
 William G. Pomeroy
 Jonathan Postel
 Henry W. Ramsey
 Brian and Loretta Reid
 Jack Roseman
 Richard Rubinstein
 Michael J. Samek
 Jonathan Singer



October 22nd, Dr. L.H. Thomas and Herbert Grosch after Grosch's lecture on the SSEC.



November 18th, Dr. and Mrs. Weizenbaum with Dr. and Mrs. Harry Huskey. During Huskey's lecture on the architecture of "Turing" computers, from the Pilot ACE to the Bendix G-15, he pointed out that before becoming famous Joe Weizenbaum worked with him on the G-15.

John F. Smith
Steve Spellman
David K. Stevenson
George Stibitz
David Tarabar
George E. Valley, Jr.
W. Joe Watson
Harvey W. Wiggins, Jr.
Richard H. Yen

Corporate Founders

Contributing \$2500 or more.

Association for Computing Machinery
Benton and Bowles
Bolt, Beranek and Newman
Boris Color Labs
British Computer Society
Robert Cipriani Associates
Clint Clemens
ComputerWorld
Control Data Corporation
Convergent Technologies
Coopers and Lybrand, Boston
Data General
Dataproducts Corporation
Digital Equipment Corporation
General Systems Group, Inc.
Ford Motor Company
Fujitsu Limited
IEEE Computer Society
Intel Corporation
MDB Systems, Incorporated
MITRE Corporation
OMNI Publications International, Ltd.
Richard Reno
Schlumberger Foundation
Software Results Corporation
Tobin Vending Service

Pray, Mr. Babbage . . .

Friday night, December 10, 1982, The Computer Museum in association with the New Ehrlich Theatre presented the premier performance of *Pray, Mr. Babbage . . .*, a character study in dramatic form written by Maurice Wilkes. This one act play is set on November 19th, 1856, when Babbage was 75 years old. The main characters are Babbage; Charles Few, his solicitor; Sir Edward Ryan, his brother-in-law; Babbage's son Henry and his wife Min.

In Wilkes' introduction to the play, he states, "As long as anyone can remember, Babbage has been working on a vast mechanical digital computer—which he calls his Analytical Engine—but has never succeeded in producing anything that would work. In consequence, the world has written him off as a crank, a verdict that history will one day triumphantly reverse. Nor is he free from the Victorian failing of indulging in personal vendettas, conducted in print, with those who have crossed his path. However, you would be very wrong if you were to think of him as an embittered and isolated man. . . ." At this time, the author is working on the kind of rewrite that is only possible after seeing a work produced.

The play was performed by actors associated with the New Ehrlich Theatre, a non-profit organization, located in the Boston Center for the Arts. Chris Rudomin, the Museum's program coordinator, worked with them to transform the cafeteria we use as a lecture hall, into a theatre. The Mayor's Office of Cultural Affairs in Marlboro, donated a stage and Lee Swanson of Warehouse

Antiques provided wonderful Victorian furniture to properly fit out Babbage's study.

The evening started at 8 PM with tree trimming, street musicians in the galleries, and seasonal potions. The play was put on at 9 PM, and the merriment continued until 11 when a crew of hardy folks struck the set—and the magic of theatre disappeared before our very eyes. All in all, more than 50 volunteers worked to make the evening a success.

The Computer Museum Slide Collection

The Computer Museum staff are currently involved in the production of a slide collection that will be available for public use and acquisition. The slide collection is intended to highlight important developments in the history of information processing as presented to the public through the Museum's broad-based collection of artifacts, photographs and documents. The series of slides consider a vast array of topics from the theory of computers to the significant technological advances of each generation and their practical use in pioneer and commercial computers. Each slide will be accompanied by a brief description of the slide and its relationship to the history of information processing.

The Computer Museum staff would appreciate your suggestions for improving the slide collection in both its scope and presentation.

Please indicate below which sets you wish to purchase and return this page with a check or money order to:

The Computer Museum
1 Iron Way
Marlboro, MA 01752

<input type="checkbox"/> Page	\$25.00 (32 slide set)
<input type="checkbox"/> Set 1	\$3.50
<input type="checkbox"/> Set 2	\$3.50
<input type="checkbox"/> Set 3	\$3.50
<input type="checkbox"/> Set 4	\$3.50
<input type="checkbox"/> Set 5	\$35.00
<input type="checkbox"/> Set 6	\$3.50
<input type="checkbox"/> Set 7	\$3.50
<input type="checkbox"/> Set 8	\$3.50
<input type="checkbox"/> Singles	\$2.00 each

Subtotal

Add 5% Sales
Tax if Mass.
resident

Add Shipping
cost of \$1.50

TOTAL

Name: _____

Address: _____

Tel: _____

Date: _____

Set 1: Information Processing History Graphs and Charts

- 1.1 Theory of Computer Generations.
- 1.2 Tree of Computer Evolution from 1950 to the 1980's.
- 1.3 The Pioneer Computers: Memory Size versus Computation Speed.
- 1.4 Speed of Calculations versus Generation for Manual through ULSI Technology.

Set 2: Early Calculating Devices

- 2.1 Napier's Bones: 17th Century Mechanical Aid to Multiplication.
- 2.2 Pascaline: Mechanical Adding Machine Invented by Blaise Pascal (1645).
- 2.3 Thomas Arithmometer: First Four-Function Practical Mechanical Calculator (1820).
- 2.4 Thacher's Cylindrical Slide Rule: Achieved the Equivalence of a Sixty Foot Slide Rule (1881).

Set 3: Hollerith's Tabulator and Sorter for the 1890 U.S. Census

- 3.1 The Computer Museum's Exhibit of Herman Hollerith's Tabulating and Sorting Machine.
- 3.2 Pantograph: Manual Device used to Punch Blank Census Cards.
- 3.3 Punched Card Reader.
- 3.4 Punched Card Sorter.

Set 4: MIT's Whirlwind Computer (1945-1953)

- 4.1 16K Core Memory Stack, Fixed Head Drum and Roomsized Console.
- 4.2 Fixed Head Drum for Secondary Memory.
- 4.3 A few of Whirlwind's 5000 Vacuum Tubes.
- 4.4 Arithmetic Elements of the 32-foot Long, 16-Bit Word.

Set 5: Early Computers

- 5.1 SAGE: AN/FSQ-7 Vacuum Tube Computer for Air Defense (1957).
- 5.2 TX-0: MIT's Full-scale, Transistorized Computer (1956).
- 5.3 PDP-1: Second Generation Computer, First Video Game "Space War" (1960).
- 5.4 PDP-8: First Mini-Computer (1965).

Set 6: Super Computers

- 6.1 IBM 7030: "Stretch" Console (1961).
- 6.2 CDC 6600: Console and Processing Cabinet, designed by Seymour Cray (1964).
- 6.3 Texas Instrument's ASC (Advanced Scientific Computer): Chassis Harness Interconnect of a Processing Unit (1971).
- 6.4 Burrough's ILLIAC IV: Burroughs Disk, Processing Cabinet and Processing Element with Fairchild Semiconductor Memory (1975).

Set 7: Logic Technology

- 7.1 Vacuum Tubes and British Valves from the Mark I circa 1950.
- 7.2 Transistor Circuitry Modules from a PDP-8 circa 1965.
- 7.3 Integrated Circuit Board from a PDP-11 circa 1972.
- 7.4 Micro-processor: Computer on a Silicon Chip circa 1976.

Set 8: Memory Technology

- 8.1 William's Tube: Cathode Ray Tube for Primary Memory circa 1948.
- 8.2 Core Memory Plane circa 1958.
- 8.3 Fixed Head Drum from English Electric's DEUCE circa 1957.
- 8.4 Hard Magnetic Disk from the "Stretch" circa 1961.

The Computer Museum Bits and Bites

Bits of history and bites for sustenance Eight Sunday Afternoons

At 2 pm, a guided tour will cover the highpoints of the Museum.

AT 3 PM, TALKS ON...

March 20
3 pm

Oliver Selfridge

**Ruminations on the
Beginnings of AI and
What Ought to Lie Ahead**

As a young assistant to Norbert Weiner, and as one of only ten participants in the first conference on Artificial Intelligence at Dartmouth, Oliver Selfridge has been involved in the development of AI from the beginning. It is from this perspective that Selfridge asks the questions, what were the early developers dreaming of in the 50's and are we dreaming the same things today?

March 27
3 pm

**Steve Russell,
Shag Graetz,
and Alan Kotok**

**Spacewar! The First
Video Game**



Russell, Graetz, and Kotok were graduate students at MIT when the new PDP-1, the first small-scale, interactive computer arrived. What started out as a demonstration of its resources turned into the development of a computer-based video game—Spacewar! Russell, Graetz, and Kotok, tell how their shared passion for sci-fi movies, games and computers drove them to invent the first video-game that is the grandfather of contemporary games. And of course, the game will be demonstrated and you will have an opportunity for a match with the past masters!

April 3
Museum closed for Easter

April 10
3 pm

**Ramon Alonso
and Albert Hopkins**

**Designing AGC: The Apollo
Guidance Computer**



When NASA wanted MIT's Draper Lab to design, construct, and deploy a computer for the Apollo mission, mini-computers were a thing of the future. What was developed was the AGC, a user-friendly computer measuring one cubic foot, that flawlessly guided the Apollo mission to the moon. Alonso and Hopkins, two of its key architects discuss how size, weight, and layout of the space capsule affected the AGC's design.

April 17
3 pm

Ted Bonn

**Early Technical Innovations
at UNIVAC**



As a member of the UNIVAC I team Ted Bonn will describe its pioneering role in the development of thin film for magnetic recordings and early computer peripherals.

April 24
3 pm

Donald Davies

**Early History of
Cipher Machines**

Dr. Donald Davies, of England's National Physical Laboratory, will talk about cipher machines, in particular the little-known Siemens T52 (used in France and Norway after World War II). He will relate it to both earlier code machines and lessons relevant to contemporary data security.

May 1
3 pm

**Charles Adams
and Jack Gilmore**

**Whirlwind for the
Small-scale User**

Charles Adams and Jack Gilmore, who were responsible for developing software for MIT's Whirlwind, the first real-time computer, tell how it was not only used for large-scale problem solving for the Office of Naval Research, but also put to practical everyday use. They will reveal how it became the first, largest, and most expensive word processor ever.

May 8
3 pm

Grace Morton

The Computer as Poet

Grace Morton is a Cambridge-based computer programmer experimenting with a new application of computer technology—generating poetry. Mother's Day provides the inspiration for her work in self-generating poetry and poetry based upon user interaction.

May 15
3 pm

Ron Resch

**The EGG: Evolution of a
Cultural Monument**



A former user of the super computers at Livermore and currently Director of the Computer Graphics Center at Boston University, Ron Resch put together his unique background in computers, the sciences, and the fine arts to design, develop, and construct the world's largest decorated Easter egg (thirty-one feet tall). This project included a number of mathematical and engineering firsts, including the development of the first geometry for an egg, and resulted in a splendid sculpture for a Ukrainian community of the plains of Alberta. Ron will show a film explaining the process, showing the construction and will talk about what's next.

A newsbrief of the collection.



What are these people doing to that machine? Under the guidance of Jay Patton of Burroughs Corporation, museum volunteers are piecing together the Iliac IV, the most recent addition to the Super Computers gallery. Mr. Patton coordinated the machine's installation at NASA Ames in 1971, deinstalled it last fall, and reinstalled it at the Computer Museum. The Iliac IV is on long term loan to the Museum from NASA. For a feature article on the Iliac IV, look for the Summer issue of the *Report*.

The
Computer
Museum

One Iron Way
Marlboro
Massachusetts
01752

Non-Profit
Organization
U.S. Postage

PAID

Marlboro, MA
Permit No. 46

THE COMPUTER MUSEUM REPORT

SUMMER 1983

1974



COLLECTIONS

WAREHOUSE

EXHIBITS



SEPTEMBER 22, 1979

PROGRAMS



VISITORS



MARCH 16, 1982



ARCHIVES
LIBRARY

MEMBERSHIP



STORE

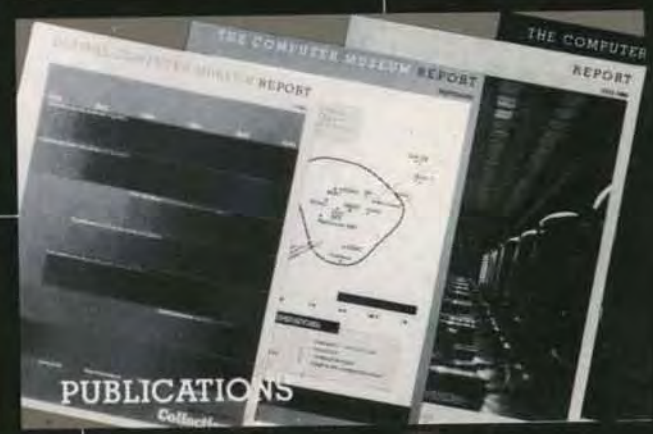

PUBLICATIONS

HISTORICAL
RESEARCH

- 1 The Director's Letter**
- 2 Illiac IV**
R. Michael Hord
- 6 Installing the Illiac IV**
Jay Patton
- 7 Collecting, Exhibiting
and Archiving**
Jamie Parker
- 8 Collections of
The Computer Museum** 
Computers and Computer
Components
Transducer Systems,
Computer Options
and Components
Calculator Systems and
Components
Memory Systems, Computer
Options and Components
Archives Acquisitions
- 18 The Year's Programs in Review**
Christine Rudomin
- 20 The Computer Historian's
Bookshelf**
Founders

Photo Credits:

David Bromfield pp. 5, 6, 9, 10, 12, 13, 14, 15, 16, 19;
Burroughs Corporation pp. 3, 4;
Digital Equipment Corporation p. 7;
Fairchild Camera and Instrument Corporation p. 2;
MITRE Corporation p. 8;
Norden Systems p. 9;
Bill Smith p. 11;
Carolyn Sweeney pp. 18, 19.

THE COMPUTER MUSEUM

The Computer Museum is a non-profit, public, charitable foundation dedicated to preserving and exhibiting an industry-wide, broad-based collection of the history of information processing. Computer history is interpreted through exhibits, publications, videotapes, lectures, educational programs, and other programs. The Museum archives both artifacts and documentation and makes the materials available for scholarly use.

The Computer Museum is open to the public Sunday through Friday from 1:00 to 6:00 pm. There is no charge for admission. The Museum's lecture hall and reception facilities are available for rent on a prearranged basis. For information call 617-467-4443.

Museum membership is available to individuals and non-profit organizations for \$25 annually and to businesses for \$125 annually. Members receive the quarterly Report, invitations to all lectures and special programs, new posters, and a ten percent discount in the Museum store.

A Founders program is in effect during the initial two-year period of the Museum, until June 10, 1984. During this period individuals and non-profit organizations may become Founders for \$250 and businesses and charitable Foundations may become Founders for \$2500. Founders receive all benefits of membership and recognition for their important role in establishing the Museum.

**THE COMPUTER MUSEUM REPORT
(ISSN 0736-5438)**

The Computer Museum Report is published quarterly by The Computer Museum, One Iron Way, Marlboro, MA 01752. Annual subscription is part of the membership of the Museum (\$25 per year for individuals and nonprofit organizations and \$125 for corporations).

The purpose is to report on the programs and exhibitions of the Museum. The contents of The Computer Museum Report may not be reproduced without written consent.

The Museum Staff is responsible for the contents of the Report. The opinions expressed do not necessarily represent those of The Computer Museum or its Board of Directors.

The design and production of the Report is done by Benson and Clemons.

BOARD OF DIRECTORS

- Kenneth H. Olsen, Chairman**
Digital Equipment Corporation
- Charles W. Bachman**
Bachman Information Systems
- C. Gordon Bell**
Digital Equipment Corporation
- Gwen Bell**
The Computer Museum
- Harvey D. Cragon**
Texas Instruments
- Robert Everett**
The Mitre Corporation
- C. Lester Hogan**
Fairchild Camera and Instrument Corporation
- Theodore G. Johnson**
Digital Equipment Corporation
- Andrew C. Knowles, III**
Digital Equipment Corporation
- John Lacey**
Control Data Corporation
- Pat McGovern**
ComputerWorld
- George Michael**
Lawrence Livermore Laboratories
- Robert N. Noyce**
Intel
- Brian Randell**
University of Newcastle-upon-Tyne
- Edward A. Schwartz**
Digital Equipment Corporation
- Michael Spock**
The Children's Museum of Boston
- Erwin Tomash**
Dataproducts
- The Honorable Paul E. Tsongas**
U.S. Senator from Massachusetts

STAFF

- Director*
Gwen Bell
- Exhibits and Archives*
Jamie Parker, Coordinator
John McKenzie
Bill Meany
Beth Parkhurst
Meredith Stelling
- Programs*
Christine Rudomin, Coordinator
- Administration*
Geri Rogers, Coordinator
David Bromfield
Debbie Sterling
- Store*
Carole Strecker, Coordinator
Sally Askins
Linda Davidson
Merle Insigna

The Computer Museum
One Iron Way
Marlboro, Massachusetts 01752
617-467-4036

The Director's Letter

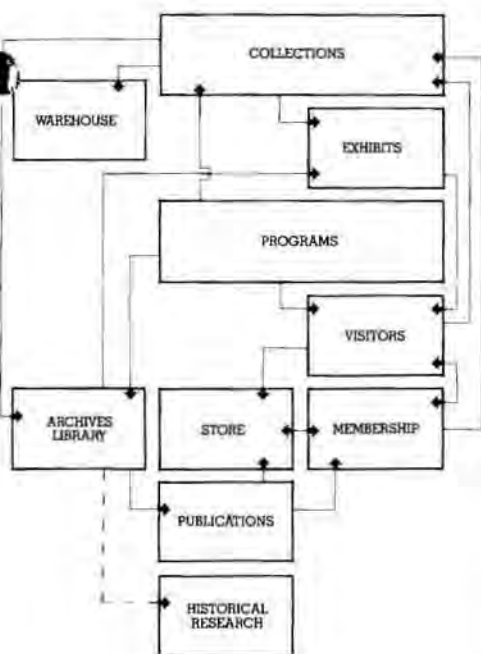

The Computer Museum operates as a system. It started out with collections, and this is still the backbone of the operation. Jamie Parker, who has been the exhibit coordinator since the museum's inception, explains this part of the operation in detail in her article. The system diagram on the left shows the interconnections and the way the Museum has evolved over time.

Our first program, a lecture by Maurice Wilkes on the EDSAC, September 22, 1979, opened the exhibits. This lecture, and each successive program, have introduced new people to the museum who in turn brought their friends to visit, providing a reinforcing positive feedback loop. The programs of lectures, seminars, field trips, and symposia are designed to improve the knowledge base of the museum and its interpretation through exhibits. The first series of lectures featured the pioneer computers and helped us to put together the timeline of these machines. The speakers aided us in this project both in their lectures and by consulting on the exhibit itself, identifying sources of artifacts and important materials for inclusion. During Harry Huskey's visit for his lecture in the fall, he identified appropriate pieces of the SWAC in storage at the Smithsonian that will be added to the Pioneer Computer Timeline and also sent us enough additional modules to complete our Bendix G-15. The Sunday Bits and Bites programs have allowed us to expand our content area to include applications, software, the arts, and the evolution of the industry.

The March 16th, 1982, notification from the Internal Revenue Service that we had received provisional status as a non-profit charitable foundation, led us to develop archives, a members program, store, and publications. The growth of the archives and library has been spurred both by the collection of artifacts and by the programs. Each artifact is often backed up with archival documentation and reference materials. All lectures and talks are recorded either by video or audio tape, edited, transcribed and made available for scholars.

The growing number of exhibits and programs drew increasing numbers of visitors allowing the establishment of a museum store to provide related educational materials. Books, posters and slides on the history of computing are the backbone of the store, but the fleamarket of old core planes, modules, manuals and calculators provides a unique opportunity: one person's excess baggage is another's heart's desire. One engineer found and reacquired an early manual that he had written, but never kept.

The Museum's members have participated in identifying appropriate programs, selecting materials for the store, and giving their time to make these things happen. The local members, with Kitty Selfridge as chairman, meet on a quarterly basis while we keep in touch with our international members through the mails.

Publication of this quarterly, slide sets and development of other materials will allow the Museum to serve its international audience. *The Computer Museum Report* will grow as the programs and exhibits develop, providing the membership with a record of the activities of the Museum. Not all of the programs are appropriate for the *Report*; some become reviewed articles published in *The Annals of the History of Computing* and others remain in the Museum archives.

As new components, such as a historical research program, are added, they too add new feedback loops that will affect the growth of the other components. What started as a simple collection is now an operating engine driving the growth and development of The Computer Museum.

Gwen Bell
Director

This 256-bit Fairchild memory chip used in the Illiac IV was the first solid-state random access memory in production. Fairchild Camera and Instrument Corporation donated twenty of their most significant chips to the Computer Museum beginning with their first planar transistor (1959).

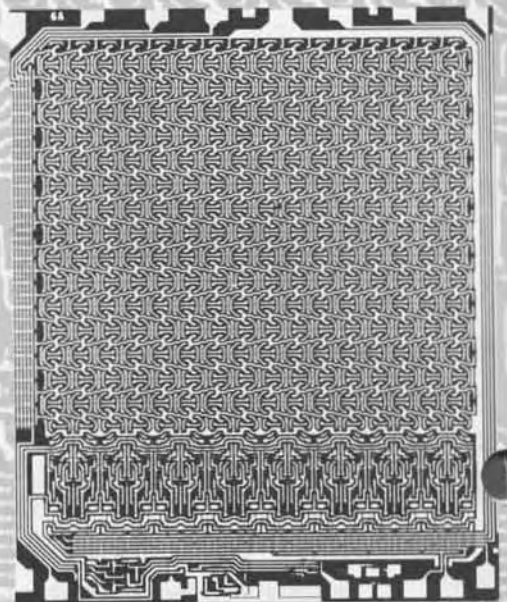

ILLIAC IV

R. Michael Hord

The most recent addition to the Museum's Hall of Super Computers is the Illiac IV, an advanced computer designed and developed at the University of Illinois in the mid-1960's by Professor Daniel Slotnick and sponsored by the Defense Advanced Research Projects Agency. On loan from NASA Ames where it was delivered in 1971 and used in computational fluid dynamics research, the Illiac IV exhibit at the Museum includes the central unit, the processing unit cabinet with eight processing units and two Burroughs disks. The following article is excerpted from R. Michael Hord's *Illiac IV, The First Supercomputer*, published in 1982 by the Computer Science Press. The book is available at the Museum store. (Reprinted with permission from the author.)

Project History

It was during the spring of 1970 that the Illiac IV computer project reached its climax. Illiac IV was the culmination of a brilliant parallel computation idea, doggedly pursued by Daniel Slotnick for nearly two decades, from its conception when he was graduate student to its realization in the form of a massive supercomputer. Conceived as a machine to perform a billion operations per second, a speed it was never to achieve, Illiac IV ultimately included more than a million logic gates—by far the largest assemblage of hardware ever in a single machine.

Until 1970, Illiac IV had been a research and development project, whose controversy was limited to the precise debates of computer scientists, the agonizing of system and hardware designers, and the questioning of budget managers. Afterward, the giant machine was to become a more or less practical computational tool, whose disposition would be a matter of achieving the best return on a government investment of more than \$31 million.

Illiac IV was funded by the U.S. Department of Defense's Advanced Research Project Agency (ARPA) through the U.S. Air Force Rome Air Defense Center. However, the entire project was not only conceived, but to a large extent managed, by academicians at the University of Illinois. Finally, the system hardware was actually designed and built by manufacturing firms—Burroughs acted as the overall system contractor; key subcontractors included



Texas Instruments and Fairchild Semiconductor.

Perhaps the greatest strength of Illiac IV, as an R&D project, was in the pressures it mounted to move the computer state of the art forward. There was a conscious decision on the part of all the technical people involved to press the then-existing limits of technology. Dr. Slotnick [...] made it clear to his co-workers that the glamour and publicity attendant to building the fastest and biggest machine in the world were necessary to successfully complete what they had started.

Design History

The story of Illiac IV begins in the mid-1960's. Then, as now, the computational community had requirements for machines much faster and with more capacity than were available. Large classes of important calculational problems were outside the realm of practicality because the most powerful machines of the day were too slow by orders of magnitude to execute the programs in plausible time. These applications included ballistic missile defense analyses, reactor design calculations, climate modelling, large linear programming, hydrodynamic simulations,

Illiac IV's amazing number crunching capabilities! Reproduced from the original Burroughs Corporation Illiac IV bulletin.

seismic data processing and a host of others.

Designers realized that new kinds of logical organization were needed to break through the speed of light barrier [186,000 miles per second] to sequential computers. The response to this need was parallel architecture. It was not the only response. Another architectural approach that met with some success was overlapping or pipelining wherein an assembly line process is set up for performing sequential operations at different stations within the computer in the way an automobile is fabricated. The Illiac IV incorporates both of these architectural features.

The Illiac IV is the fourth in a series of advanced computers from the University of Illinois; its predecessors include a vacuum tube machine completed in 1952 (11,000 operations per second), a transistor machine completed in 1963 (500,000 operations per second) and a 1966 machine designed for automatic scanning of large quantities of visual data. The Illiac IV is a parallel processor in which 64 separate computers work in tandem on the same problem. This parallel approach to computation allows the Illiac IV to achieve up to 300 million operations per second.

The logical design of the Illiac IV is patterned after the Solomon computers. Prototypes of these were built in the early 1960's by the Westinghouse Electric Company. This type of computer architecture is referred to as SIMD, Single Instruction Multiple Datastream. In this design there is a single control processor which sends instructions broadcast style to a multitude of replicated processing units termed elements. Each of these processing elements has an individual memory unit; the control unit transmits addresses to these processing element memories. The processing elements execute the same instruction simultaneously on data that differs in each processing element memory.

In the particular case of the Illiac IV, each of the processing element memories has a capacity of 2,048 words of 64-bit length. In aggregate, the processing element memories provide a megabyte of storage. The time required to fetch a number from this memory is 188 nanoseconds, but because additional logic circuitry is needed to resolve contention when two sections of the Illiac IV access memory simultaneously, the minimum time between successive operations is somewhat longer.

In the execution of a program it is often necessary to move data or intermediate results from one processor to another. One way of regarding this interconnection pattern is to consider the processing elements as a linear string numbered from 0 to 63. Each processor is provided a direct data path to four other processors, its immediate right and left neighbors and the neighbors spaced eight elements away. So, for example, processor 10 is directly connected to processors 9, 11, 2, and 18. This interconnection structure is wrapped around, so processor 63 is directly connected to processor 0.

The other major control feature that characterizes the Illiac IV is the enable/disable function. While it's true that the 64 processing elements are under centralized control, each of the processing elements has some degree of individual control [provided] by a mode value. For a given processor [it] is either 1 or 0, corresponding to the processor being enabled "on" or disabled "off". The 64 mode values can be set independently under program control, depending on the different data values unique to each processing element. Enabled processors respond to commands from the control

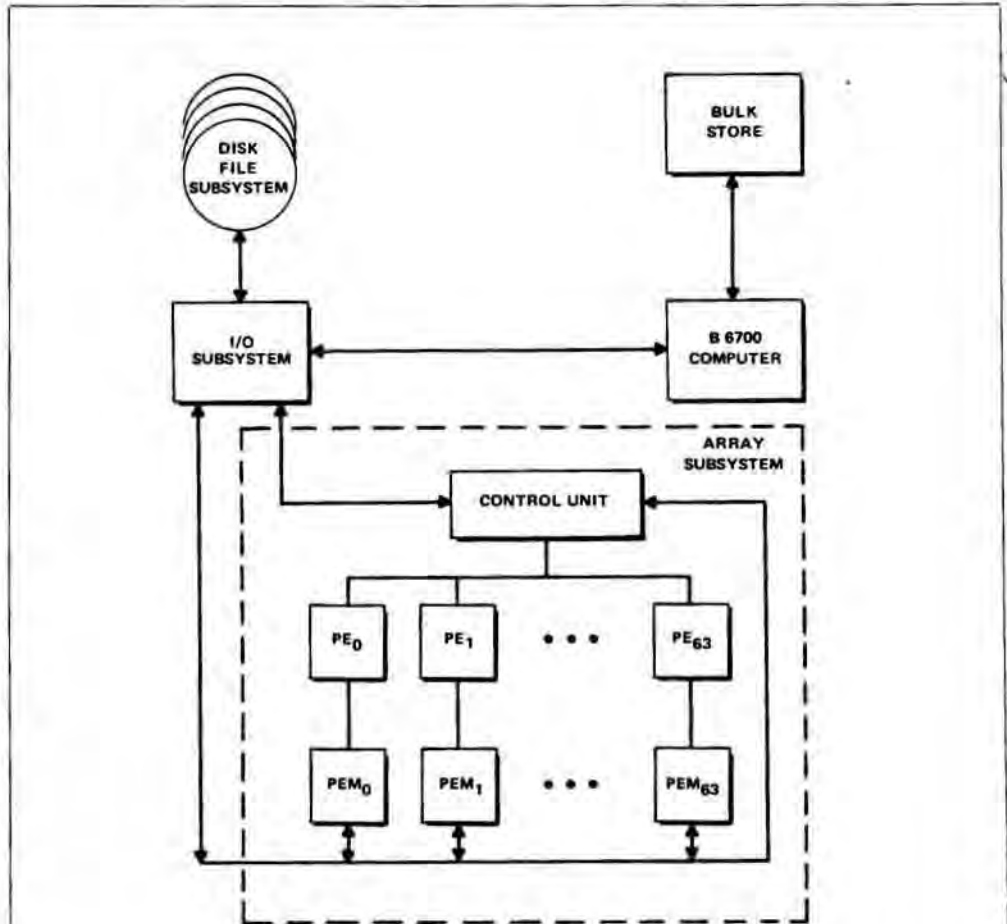

Illiac IV functional diagram.

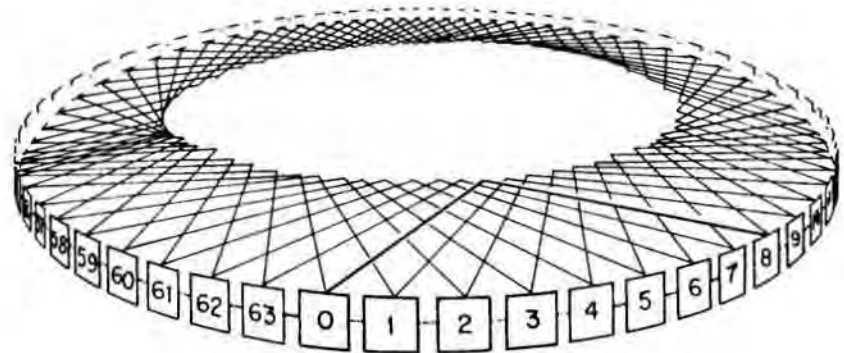

This routing diagram shows schematically the neighbor-to-neighbor linkages which form the 64 processing elements (PE) into a ring, as well as the connections of the PE's eight apart such that data can bypass intermediate PE's when the distance to be covered is large.

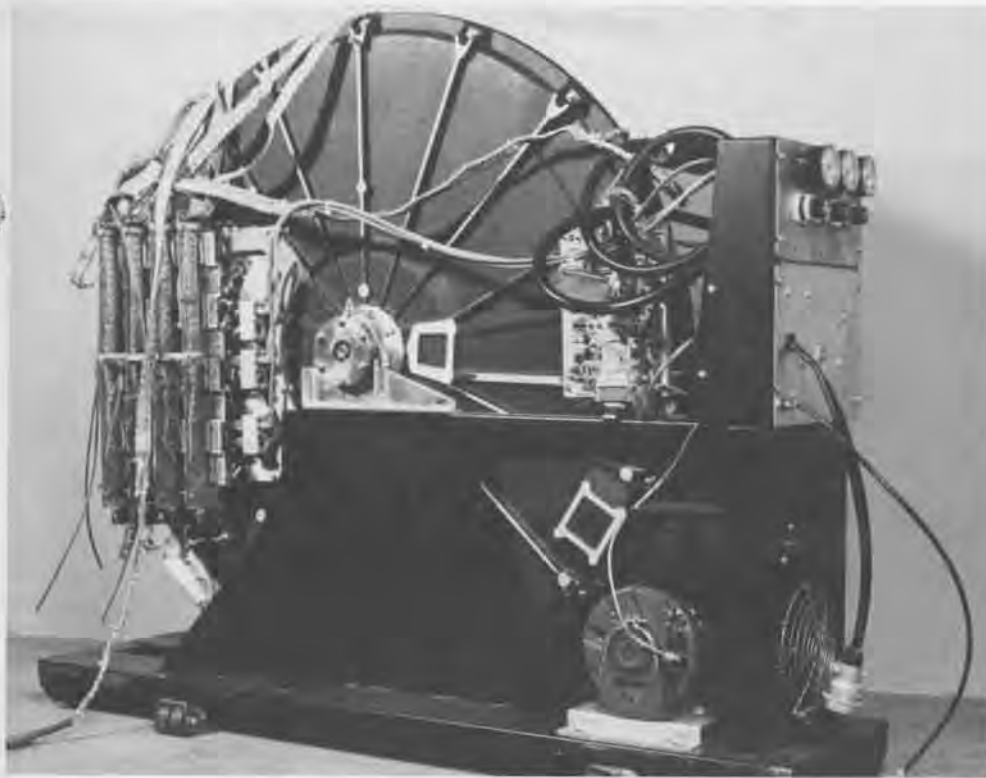

This Burroughs Disk exhibited at The Computer Museum is only one of the thirteen synchronously rotating fixed head disks that comprised the 16M word main memory of Iliac IV.

unit; disabled elements respond only to a command to change mode. Mode values can be set on specific conditions encountered during program execution. For example, the contents of two registers can be compared and the mode value can be set on the outcome of the comparison. Hence iterative calculations can be terminated in some processors while the iteration continues in others, when, say, a quantity exceeded a specific numerical limit.

In addition to the megabyte of processor element memory, the Iliac IV has a main memory with a sixteen million word capacity. This main memory is implemented in magnetic rotating disks. Thirteen fixed head disks in synchronized rotation are organized into 52 bands of 300 pages each (an Iliac page is 1,024 words). This billion-bit storage subsystem is termed the Iliac IV Disk Memory or 14DM. The access time is determined by the rotation rate of the disks. Each disk rotates once in 40 milliseconds so the average access time is 20 milliseconds. This latency makes the access time about 100,000 times longer than the access time for processor element memory. The transfer rate, however, is 500 million bits per second.

This memory subsystem, the input/output peripherals and the management of the other parts of the system [were] under the direction of a Digital Equipment Corporation PDP-10 conventional computer. A Burroughs B-6700 computer compiles the programs submitted to the Iliac into machine language.

Circuitry

Initial plans for Iliac IV circuitry envisioned bipolar emitter-coupled logic (ECL) gates capable of speeds of the order of 2-3 ns. The ECL circuits were to be packaged with 20 gates per chip—a level of complexity that later would be called medium scale integration. [Texas Instruments was chosen as the subcontractor for these circuits.] Iliac IV initial specifications called for a 2,048-word, 64-bits-per-word, 240-ns cycle time memory for each of its processing elements. In 1966, the only technology that seemed to meet the requirements was the thin-film memory. At that time, a few developmental semiconductor memory chips were being studied, but no computer manufacturer would yet consider them seriously for main memory use.

[However, a change] to smaller ECL circuit chips proved a death blow to thin-film memory. When the smaller chips' requirements for added space on circuit boards and interconnections were taken into account, it turned out that there was not enough room for the smallest feasible thin-film memory configuration. Strangely, the failures of the ECL circuits and thin-film memories also set the stage for a brilliant hardware success: Iliac IV was to be one of the first computers to use all semiconductor main memories. Slotnick chose Fairchild as the semiconductor memory subcontractor.

Called for were 2,048 words (64 bits/word) of memory for each of the 64 Iliac processing elements, a total of 131,072 bits per processing element. The mem-

ory was to operate with a cycle time of 240 ns and access time of 120 ns. Slotnick recalls the development proudly: "I was the first user of semiconductor memories, [and] Iliac IV was the first machine to have all-semiconductor memories. Fairchild did a magnificent job of pulling our chestnuts out of the fire [...] the memories were superb and their reliability to this day is just incredibly good."

Results

The end results this pioneering [project] had on computer hardware were impressive: Iliac IV was one of the first computers to use all semiconductor main memories; the project also helped to make faster and more highly integrated bipolar logic circuits available; in a negative but decisive sense, Iliac IV gave a death blow to thin-film memories; the physical design, using large, 15-layer printed circuit boards, challenged the capabilities of automated design techniques.

Installing the Illiac IV

Jay Patton



Jay Patton, Manager of Installation Planning at Burroughs Corporation, coordinated the initial set up of the Illiac IV at NASA Ames in 1970 and came to the Computer Museum in December to reinstall it. Comments made during his gallery talk follow, conveying an idea of the massive size of the computer and its capabilities.

"In 1970, ARPA (Advanced Research Project Agency) determined that the Illiac IV parallel architecture could best be tested in an environment that had research programs requiring the potential power of the machine. A new wing was built to house Illiac IV. It took one month to disassemble the unit from our testbed in Paoli, which had 100 tons of air conditioning built into it. The computer totalled 53' in length, and took 11 40' vans to house it, weighing 99 tons. One truck alone had only power supplies in it.

Illiac IV had a total of 11,739 pc boards. You can imagine what the spares problem was, and projecting what the failure rate would be. There was a group of people who did nothing but work on equations such as the mean time between failure rate. Inside each pc board were 12 layers of pc material. Each of the boards is coded with a letter code at the top, and a number code at the bottom. You cannot physically put a wrong board in the wrong spot.

From the control unit to each one of the processing extenders (which is a separate computer all in itself) there were belted cables in the back running the length—in one unit alone, there's over 85 miles of cable. The cooling air was 45,000 cubic feet of air per minute. It used over a half a megawatt of power. When we turned it on, we had to do it by sections, not all at once.

The disk system had a transfer rate of 500×10^6 bits per second, when you had two disks running in parallel. The parallel concept for Illiac was used to bypass the speed of light limitation, because you could do 64 additions, subtractions, or multiplications simultaneously. The maximum speed intended by the design was 200×10^6 operations per second; it actually achieved an effective speed of over 60 million instructions per second on some applications.

You can imagine the traumatic experience I had when I compared the 1970 National Geographic photograph of the Illiac IV and the recent National Geographic (October 1982) photograph of Illiac being torn apart and having an autopsy done on it. Then you can imagine how I felt when a call came from Marcie Smith [NASA Ames] to tell me that the Computer Museum was going to ask me to help put Illiac back together—she asked me to control my laughter. The computer really was the dinosaur of the sixties. What you see in the museum are the skeletal remains of a once-proud unit."

Collecting, Exhibiting and Archiving

The Exhibits and Archives department rarely refuses donations offered to expand the collection. With computing technology changing so rapidly, determining the future significance of a piece is difficult. To turn away a potential acquisition because it seems less important hinders the future growth of the collection. The collection now numbers about 450 pieces, representing the largest holding of computer artifacts anywhere.

As the Museum has evolved, it has established a close relationship with its members and friends—engineers, computer scientists and history buffs—who are responsible for many donations. Often they refer the department to an available artifact, or make a donation from their own collections. When an object is offered to the collection, they act as curators, illuminating the importance of the acquisition, and sometimes preparing text for an exhibit. While not actually employed by the Museum, they act in its behalf as the experts in computing technology.

The collections policy outlines the process of acquiring artifacts. A deaccessioning clause clarifies to donors that the piece they donate today may not always be part of the permanent collection for reasons of space, a lessening of historical value, or duplication. The deaccessioning policy contributes to our habitual "squirreling" of artifacts; the donor has agreed that the piece may be taken off the catalog listing and traded with another Museum for another piece, or its

parts, if it is a duplicate, could be sold to other collectors through the Museum store. Very little is ever scrapped.

After determining the significance of an acquisition, the artifact is pursued. Most acquisitions require a little detective work and some phone calls to ensure shipment, while a few others are more elusive. In June of 1981, Greg Mellen from Univac in St. Paul called to say he had located a part of the 1956 NTDS (Naval Tactical Data System) in an office in St. Paul. Seymour Cray was the director of development for the NTDS project, the first automated command and control system within the Navy. Initial letters were mailed and calls made to guarantee the CP-642's release to the Museum. It was not until June of 1982 that the paperwork arrived in a large package from the Navy. In order to clear the CP-642, the Navy needed several letters of intent and background from the Museum, all of which had to be notarized, establishing ourselves as a reputable agency for the preservation of computing history. Another six months later, after several follow-up calls, the Navy wrote that they needed a statement from the state of Massachusetts that the Museum was, indeed, tax exempt. In January, 1983, the Navy informed us that the CP-642 was in an office in St. Paul, presumably not due to be shipped until April, 1983, almost two full years after the process started.

When an acquisition arrives at the Museum, it is checked for damage and suitability for immediate display (this usually involves climbing through 40 foot trucks, removing quilted covers and making some on-the-spot decisions). When the nine tons of Illiac IV arrived completely disassembled on the shipping dock—with no Illiac IV experts available in Marlboro—most of the machine, with the exception of the skeleton and several processing units, was sent to storage. Through a contact at NASA Ames, we located Jay Patton at Burroughs, who had originally installed the computer at NASA. Jay spent two days at the Museum, retrieving what had been mistakenly shipped away, and piecing Illiac back together.

A sequential identification number is assigned, with the last two digits representing the year of the donation. Each artifact is catalogued by manufacturer, serial number, phys-

ical description, date and place in computing history, donor name and address, special characteristics, and a brief explanation of the artifact. It is cross referenced to its archival documentation if any exists. An acknowledgement letter, collections policy and receipt for tax purposes are sent to the donor for his records.

The Museum's archives and library began with active solicitation of documentation of collected machines. The understanding was that original manuals would be worthwhile research materials in years to come. This has evolved to the point where relevant photographs, theses, books, films and videotapes are also collected. In collecting archival material, the leads of the Museum's friends and donors are investigated. Contacts for archival material include libraries who wish to donate surplus material from their shelves, and individuals going through personal document collections. On the night of Maurice Wilkes' "Pray, Mr. Babbage" premiere, Mary Hardell donated volume one, number one of the *ACM Journal* and Bill Luebbert donated a full set of the videotapes from the Los Alamos computer conference. A new acquisition, such as Illiac IV, precipitates outside interest and donations. People who worked on the machine or at the University of Illinois are going through file drawers and attics to collect supplementary materials for us.

This summer's *Report* lists the whole collection by appropriate categories. Only one-third of the permanent collection is exhibited, with all material that is in storage documented and available for research purposes. As the collection and exhibitions grow, the ratio will probably remain the same. Some parts of the collection are better developed than others, but by looking at what has been collected, it is easier to determine what should be pursued. The collection's growth reflects a new understanding of the importance of preserving computer history, and the many milestones within the computer industry. Active involvement from members, friends and experts in certain areas of computing technology is an invaluable resource in this development.

Jamie Parker
Exhibits and Archives Coordinator

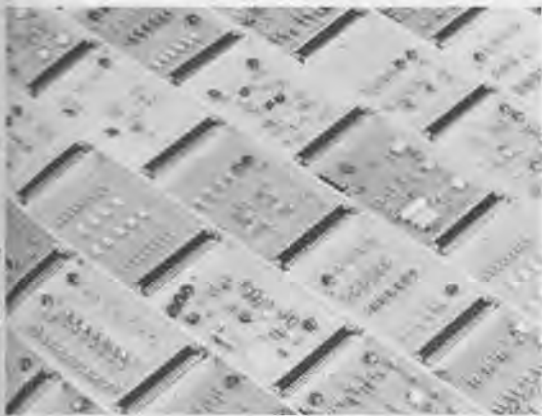

These Digital Equipment Corporation modules circa 1962 are examples of some of the components the Museum accepts for exhibition, reference or sale in the Museum store. The photograph is part of the archival collection.

Digital Equipment Corporation
PDP-8

Word Length: 12 bits

Memory Size: 4,096 words (expandable to 32,768 words)

Speed: 333,333 single address instructions per second
1.5 microsecond memory cycle time

Clock rate: 1 Mhz

Arithmetic element: Accumulator and 8 auto-index registers in memory

Instruction format: Single address 3 bit op code, indirect bit, 1 page bit and 7 page address; 32,768 word addressable memory

Technology: Digital R series logic

Power consumption: 780 watts

Size: 8 cubic feet

Number produced: Approximately 5000

Price: \$18,000 with 4,096 memory and ty

Project start: 1964

First delivery: April 1965

Predecessor: PDP-5

Successors: PDP-8/S, LINC-8, 8/I, 8/L,

Software: PAL-8 assembler, Macro 8 asse
Editor, RT-8, and OS-8 operating stand-alone operation systems
using DECTape and diskpaks

Use: Real time control and data collection. First OEM (Original Equipment Manufacturer) computer. Data communication. Small business data processing. Timeshared computation for very low cost per terminal.

Achievements: Provided the lowest cost computation and performance per unit cost. Produced in high volume; manufactured using wire-wrap technology. Improved ease of interfacing - first DEC computer to use I/O bus structure. Lowest cost per terminal with TSS/8 (smallest scale timesharing system).

Source: The MITRE Corporation
Burlington Road
Bedford, Massachusetts

Reference: Documentation in location TZ-AR16; boxes 20-22.
Handbooks and manuals in location TZ.



Exhibit Coordinator Jamie Parker signs the donation contract for a PDP-8 from MITRE Corporation with Ed Townsend of MITRE. The Museum's collection includes several classic PDP-8's. One is exhibited in the Four Generations Gallery. The others, now in storage, will be loaned to museums.

Digital computers emerged in the late nineteen-forties from a combination of calculator, control, transducer, links and switches, and memory technologies. They are more than a sum of these parts, as the parts have converged and been modified and molded into a new phenomenon. The listing includes computers and components representing the four generations of computing technology.



The Alto was designed in 1973 by Xerox Palo Alto Research Center as an experiment in personal computing with the goal of providing sufficient computing power, local storage, and input-output capability to satisfy the computational needs of a single user. The Alto significantly changed the office computing environment through its interactive nature and communication applications, such as electronic mail. On loan from Xerox PARC.

The Norden PDP-11/34M (1976) was a fully militarized version of the DEC PDP-11/34 minicomputer. Built to perform in the severest of military environments, the PDP-11/34M was used for applications ranging from tactical avionics to complex command and control.

DIGITAL COMPUTERS

Bendix G-15 (X48.82)
Gift of the Science Museum of Minnesota

Burroughs Corporation and University of Illinois, Illiac IV (X137.82)

Loan from NASA Ames Research Center

Clary Corporation, Clary DE60 (X119.82)
Gift of Colburn Engineering

Clary Corporation, Clary DE600 (X123.82)
Gift of Ed Downing, Doland Corporation

Control Data Corporation, CDC 160A
Loan from Control Data Corporation

Control Data Corporation, CDC 6600 (X38.81)
Gift of Lawrence Livermore National Laboratory

Data General Corporation, NOVA (X84.82)
Gift of Data General Corporation

Digital Equipment Corporation, MINC (D155.80)
Gift of Digital Equipment Corporation

Digital Equipment Corporation, PDP-1 (XD116.79)
Gift of Inforonics Corporation

Digital Equipment Corporation, PDP-1 (X99.82)
Gift of Center for Computer Science, Harvard University

Digital Equipment Corporation, PDP-5 (X178.83)
Gift of School of Engineering and Applied Science, Washington University in St. Louis

Digital Equipment Corporation, PDP-7 (XD143.80)
Gift of Worcester Polytechnic Institute

Digital Equipment Corporation, PDP-8 (D117.80)
Gift of Digital Equipment Corporation

Digital Equipment Corporation, PDP-8 (X161.82)
Gift of Dr. Simon, University of Rochester Medical Center

Digital Equipment Corporation, PDP-8 (X167.83)
Gift of the MITRE Corporation

Digital Equipment Corporation, PDP-8/L (X165.83)
Gift of Robert Miller

Digital Equipment Corporation, PDP-11/23 Microcomputer (D33.80)
Gift of Digital Equipment Corporation

Digital Equipment Corporation, PDP 11/34 M (X177.83)
Gift of Norden Systems

Digital Equipment Corporation, PDP-11/45 (D9.81)
Gift of Digital Equipment Corporation

Digital Equipment Corporation, PDP-12 (D156.81)
Gift of Digital Equipment Corporation

Fairchild Camera and Instrument Corporation, Symbol Machine (X117.82)
Gift of Iowa State University

Honeywell, Interface Message Processor (X105.82)
Gift of Bolt, Beranek and Newman Inc.

International Business Machines Corporation, IBM 7030, "Stretch" (XD250.81)
Gift of Computer Services, Brigham Young University

International Business Machines Corporation, IBM 1130 (X166.83)
Gift of John Richards

International Business Machines Corporation, IBM 1620 (X169.83)
Gift of David Goodwin

Librascope General Precision, LGP-30 (X14.81)
Gift of MIT Museum and Historical Collections

Lincoln Laboratories, LINC (D118.79)

Lincoln Laboratories, TX-O (D154.75)
Gift of Digital Equipment Corporation

MIT, Altair 8800 (X58.82)

Massachusetts Institute of Technology, Whirlwind (D29-32.73)
Gift of Digital Equipment Corporation

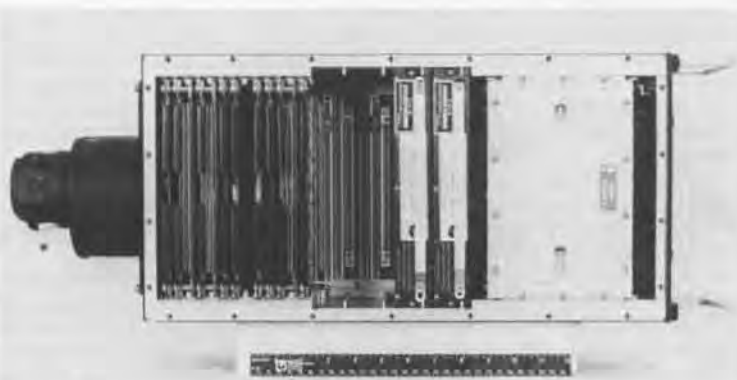

NASA Apollo Guidance Computer Prototype (X37.81)
Gift of Charles Stark Draper Laboratory

Philco-Ford 212
Gift of Ford Motor Company

Raytheon, Polaris Guidance Computer (X89.82)
Gift of Charles Stark Draper Laboratory

Remington Rand, Univac Solid State 80 (X33.81)
Gift of Jodie S. Hobson

Siemens 2002 (X20.81)
On loan from Siemens Corporation

Sperry Univac CP-642/USQ-20 (X184.83)
Gift of Naval Sea Systems Command

Texas Instruments, Advanced Scientific Computer (XD224.80)
Gift of Texas Instruments

Viatron Computer Products, System 21 Intelligent Terminal Microprocessor (X109-11.82)
Gift of Nick Wise

Xerox Corporation, Alto 1 (X124.82)
Loan from Xerox Corporation

COMPUTER COMPONENTS

Amphenol, Vacuum Tubes (X77.80)
Gift of Gary Papazian

Bell Telephone Laboratories, Transistor GA-51984 (X31.81)
Gift of Carver Mead

Bendix G-15 Bit Slice (D202.80)

Bendix G-15, Logic Modules (X181.83)
Gift of Harry D. Huskey

Berkeley Scientific Corporation, Decimal Counting Unit (D205.80)

Burroughs Corporation, E-101 Computer Program Pin Board (X102.82)
Gift of Bill Smith

Clar Stat Amerpette, Ballast Resistor Tubes (Regulators) (X79.80)
Gifts of Gary Papazian

Computer Controls Corporation, Logic Module (D111.80)

Control Data Corporation, STAR Logic Module (XD218.80); 6600 Transfer Board (XD223.80)
Gifts of Lawrence Livermore National Laboratory

Cray Research Inc., Cray I Interface Module (XD226.80)
Gift of Lawrence Livermore National Laboratory

DCS Power Amplifier (X60.82)
Gift of Bob Glorioso

Digital Equipment Corporation, Bit slice triple flip-flop (D201.80); Classroom Module (D206.80); Flip-chip Modules (D213.80); LSI 11 Module (D35.80); PDP-6 System Logic Module; PDP-8/1 Logic Module (D220.80); PDP 11/20 Module Artwork (D22.79); System Building Block (D203.80); UART Four Channel Asynchronous Serial Interface (D36.80); VAX Prototype UBA (D166.80)
Gifts of Digital Equipment Corporation

Digital Equipment Corporation, PDP-5 Accumulator Boards (X21.81)
Gift of David Razler

Digital Equipment Corporation, PDP-1 Parts and Manuals (X347.82)
Gift of Ramin Khorram, President MIT Electronic Research Society

Digital Equipment Corporation, PDP-8/1 (X182.83)
Gift of Computer Transceiver Systems

Electronic Associates Inc., 31R Computer Patch Panel (X88.82)
Gift of John Runyon

English Electric Company, Deuce Arithmetic Logic Element (XD4.75)
Gift of Murray Allen

ENIAC Function Table
Loan from the Smithsonian Institution, National Museum of History and Technology

Fairchild Camera and Instrument Corporation, Collection of integrated circuits chronicling Fairchild logic and memory history from 1959 to 1977 (X106.82)
Gift of Fairchild Camera and Instrument Corporation

Fairchild Semiconductor, Semiconductor (X71.82)
Gift of Bob Glorioso

Ferranti Corporation, Atlas 1 Printed Circuit Board (XD1.75); Atlas 1 Digits (XD2.75)
Gift of F.H. Sumner

Ferranti Corporation, Atlas 1 Four Flip-flop Board (X53.81); Mark I Logic Door (X56.82)
Gifts of Department of Computer Science, University of Manchester

Ferranti Corporation, Atlas 1 Printed Circuit Board (XD128.80)
Gift of Rutherford Laboratory

FUJITSU Ltd., Relay No. 56 (XD71.79), Parametron (XD73.79), Logic Circuit Diagrams (XD77.79), FACOM 100 Relay (XD106.80)
Gifts of FUJITSU, Ltd.

General Dynamics Form Flash Plates from Stromberg Carlson SC4020 (XD131.80)
Gift of Rutherford Laboratory

General Electric, Semiconductor (X70.82)
Gift of Bob Glorioso

Hamilton Standard, Microcircuit Module (X96.82)
Gift of Bob Glorioso

Harvard University, PDP-1 Space Pen (X164.83)
Gift of Harvard University, Division of Applied Sciences

Honeywell Sense Amplifier H4200/8200 (XD253.81)
Gift of Phil Goldman

Intel, 4004 and 8008 Chips (X127-128.82)
Gifts of Eugene Flath, Intel.

International Business Machines Corporation, 22XX Printer Buffer Array, Logic card from an IBM Printer (XD132.80)
Gift of Rutherford Laboratory

International Business Machines Corporation, IBM 360/91 Console (X73.82)
Gift of Howard Eskin, Columbia University

International Business Machines Corporation, IBM 360/195 Console (X180.83)
Gift of Rutherford Appleton Laboratory

International Business Machines Corporation, IBM 650 Logic Module (XD12.75)
Gift of Murray Allen

International Business Machines Corporation, SMS Logic Module (D113.80)

Manchester University, Mark I Valve (XD5.75)
Gift of Department of Computer Science, Manchester University

MITTS, Altair 8800 CPU Board (X6.80)
Gift of Ed Luwish

Motorola, Semiconductor (X68.82)
Gift of Bob Glorioso

Motorola, Zener Diode (X97.82)
Gift of Bob Glorioso

National Union, Vacuum Tubes (X76.80)
Gifts of Gary Papazian



On behalf of Iowa State University, Professor Roy Zingg presented Fairchild's Symbol IIR to the Museum and explained the machine's history and development during a gallery talk. SYMBOL was designed and built at the Digital System Research Department of Fairchild's Research and Development Division between 1963 and 1970, and purchased by Iowa State with the support of an NSF grant. SYMBOL operated at Iowa State until 1978 as a working system that demonstrated a radical computer architecture; an early example of top-down design where the end product was envisioned as an in-house, time-sharing, interactive system that would be user friendly. "SYMBOL proved that a sophisticated system could be implemented directly in hardware," Zingg stated. "It motivated the invention of dual-in-line integrated circuit packaging. The designers of the machine tried to push the limits, which I think is quite proper in a research environment, but probably a sure way to the poorhouse in a commercial environment."



Bill Smith donated a pin board from the 1956 Burroughs E101 computer and gave a gallery talk on the use of the E101 in predicting the Eisenhower-Stevenson election results in 1956. An excerpt from his gallery talk follows.

"The E101 was a single address, pin board programmed machine, with a 100 word drum memory, a speed of 3600 rpm and a stepping switch segment that picked up instructions. Instruction fetching was done by stepping switches through sequences across the top of eight pin boards of sixteen steps each. The operator could stop the computer to remove some pin boards and resume or do supplemental steps with a paper tape at ten characters per second, or three instructions per second. Instructions were fetched in about 25 milliseconds, and accounting for drum latency, the speed averaged 10-15 instructions per second. Subroutines, usually constrained by

programmers to fit within a pinboard, took anywhere from 1 to 10 seconds.

"Dr. Saul Rosen pioneered election predictions in 1954 in Detroit using Wayne University's UDEC #2, produced by Burroughs and the University of Pennsylvania's Moore School of Electrical Engineering. They predicted the Michigan gubernatorial and U.S. Senate seats and broadcast the results through a radio affiliate. For the Eisenhower-Stevenson election in 1956, we had the pre-accumulated results from the last election from which to make our differential forecast. We brought the Burroughs E101 desk sized computer to the city room of the Detroit Times and had live camera coverage during the evening.

"On election night, an operator would enter data at a keyboard, and since all of the precincts could not be retained in memory, we entered the previous years' results and then computed to get the pre-

dictions and judge convergence. Every time we got twelve to twenty new precincts in, we would do another run to test for a new convergence point. The operator entered the previous years' results, the differential, and the new results from this sampling, and then did a comparison, an extraction and finally forecast the prediction on live black and white television.

"For Stevenson and Eisenhower, we were within a percent and a half in the final prediction, both in percentage and in coarse total count. If you'd been listening to the networks, you would have heard that the 701 was down or the 650 was down. They were always breaking down due to the high temperatures created by the 1500 watt spot lights and no air conditioning. It wasn't until the sixties with transistors that machines became reliable enough to run through the whole election evening."

PCK Technology
Multi Wiring Machine (X185.83)
Gift of PCK Technology Division,
Kollmorgen Corporation

Philco, Transistors (X64.82)
Gifts of Bob Glorioso

Raytheon, Electron Tubes (X74.82)
Gifts of Gary Papazian

Raytheon, Power Transistor 2N1662
(X59.82)
Gift of Bob Glorioso

RCA, Radio and Electron Tubes
(X75.80)
Gifts of Gary Papazian

RCA, Transistors (X72.82)
Gifts of Bob Glorioso

SDS-SD Sales, S-100 CPU Board
(XD236.81)
Gift of David Ramsperger

Sperry Rand, Solid State
Components (X95.82)
Gift of Ted Bonn

Sylvania, MOBIDIC Logic Board
(XD192.80)
Gift of Frank Feigin

Texas Instruments, Semiconductors
(X61.82)
Gifts of Bob Glorioso

Transitron, Diodes (X63.82);
Semiconductor (X69.82)
Gifts of Bob Glorioso

University of Illinois, ILLIAC II
BLOCK Multiplexor called
"Interplay" (XD216.75); ILLIAC III
Printed Circuit Module
Gifts of Clifford Carter

Westinghouse, RTL Integrated
Circuits (X62.82)
Gifts of Bob Glorioso

Transducers take information in one form and put it into another. The earliest example is moveable type and now includes the teleprinter, tape transport, telephone, and television. These machines are becoming more and more sophisticated and less distinguishable from computers.



The Texas Instruments Speak & Spell was designed as a child's learning aid for spelling using electronically synthesized speech to give the words and an alphanumeric keyboard and display for entry of the answer. The Museum's Speak & Spell, gift of W.R. Hawkins and Gene Frantz, members of the project team, is an early model that was demonstrated on the Today show in 1978.

- Adler, Adler-Klein Typewriter (X146.82)
Gift of Clark Prestia
- Adler, Typewriter Model No. 7 (X148.82)
Gift of Clark Prestia
- American Typewriter Company, Model No. 8 Typewriter (X152.82)
Gift of Clark Prestia
- ASR, Teletype Writer (X130.82)
Gift of Richard Ten Haken

A.E.G. Deutsche Werke Schreibmaschinen Gesellschaft, Mignon AEG Modell 4 Typewriter (X150.82)
Gift of Clark Prestia

Digital Equipment Corporation, Type 30A CRT (X25.81)
Gift of Harvey Wiggins

Digital Equipment Corporation, 338 Display Unit (X23.81)
Gift of Ford Motor Company

Digital Equipment Corporation, GIGI (D276.82); GT-40 (D10.81); VT 105 (X36.81)
Gifts of Digital Equipment Corporation

Digital Equipment Corporation, VT 105 (X36.81)
Gift of American Computer Group Inc.

Allen B. Du Mont Laboratories, Inc., Cathode-Ray Oscillographs (X26-8.81)
Gifts of Ken Olsen

Edison Company, Ediphone, Utility Shaver and Voice Recorder (D121.80)

"Enigma" (B197-8.81)
Loan from Gordon and Gwen Bell

Friden Corporation, Friden Paper Tape Reader (X9.80)
Gift of Ed Luwisch

Friden, Flexewriter (X107.82)
Gift of Rick Merrill

General Automation Corporation, Stored Program Controller,
Gift of Taan Lee

Hammond Typewriter Company, Hammond Folding Multiplex Typewriter (X145.82)
Gift of Clark Prestia

Harris Typewriter Company, Harris Visible Typewriter (X155.82)
Gift of Clark Prestia

International Business Machines Corporation, IBM Card Punch (X40.80)

International Business Machines Corporation, IBM Auto-typist Perforator and Printer (X16-7.81)
Gifts of Solomon Schecter Day School

International Business Machines Corporation, IBM 650 Control Panel (X129.82)
Gift of Tony Crugnola

International Telephone and Telegraph, Teletype (D117.80)
Gift of Jack Brown

C. Lorenz A-G, Telegraph Transmitter (X30.81)
Gift of Alexander Vanderburgh Jr.

Martin Marietta Corporation, Clary Printer adapted for computer output (XD208.80)
Gift of Clyde Still

Bennett Typewriter Company, Bennett (X154.82)
Gift of Clark Prestia

Bingwerke, Bing No. 2 Typewriter (X142.82)
Gift of Clark Prestia

Blickensderfer Manufacturing Company, Blickensderfer Model No. 7 (X144.82)
Gift of Clark Prestia

Bunnell, Telegraph Sender and Receiver (XD229.80)
Gift of Rodney Bamford

R.C. Burt, 2 Amplifiers (X112-13.82)
Gift of D.H. Lehmer

California Computer Products, Calcomp Model 565 Digital Incremental Plotter (X103.82)
Gift of J.C. Deck, Inland Steel

Harold Cohen, "Turtle" (X50.82)
Loan from Harold Cohen

Columbia Graphophone Company, Dictaphone, Shaver, Transcriber (D123.79)

Corona Typewriter Company, Inc., Folding Portable No. 3 (X149.82)
Gift of Clark Prestia



The "Blick" was the first typewriter intended to be readily portable. Designed and patented by George Blickensderfer in 1890, it was first sold in 1893. Each key had three positions, upper and lower case and a figure that positioned three levels of the printing wheel. Gift of Clark Prestia.



The Mignon typewriter is an indicator-type of machine, employing a stylus and a printed character table to manipulate the machine. Manufactured in Germany in 1908, the Mignon's advantage was its interchangeable letter table and type wheel, allowing typing in different languages. The Mignon is one of a gift of twenty-two typewriters from Clark Prestia. The donation represents an important part of the history of transducer equipment.



Produced in 1910 by the Hammond Typewriter Company, the Multiplex had a folding feature designed by Charles Nook for portability. It had interchangeable type shuttles, allowing 17 different styles of type and characters for more than 50 languages. The Hammond Multiplex is a gift of Clark Prestia.

Nixdorf Computer, Printer Head (X100.82)
Gift of Frank Digilio

The Noiseless Typewriter Company, "Noiseless Typewriter" (X5.80)
Gift of Ed Luwish

The Noiseless Typewriter Company, "Noiseless Typewriter" (X18.81)
Gift of Trudy Leonard

Norden Systems, World War II Bombsight (X176.83)
Gift of Norden Systems

Oliver Typewriter Company, Oliver No. 5 Standard Visible Writer (X156.82)
Gift of Clark Prestia

Railroad Telegraph Transmitter (XD182.80)
Gift of Cliff Granger

Reliance Typewriter Company, Reliance Visible (X158.82)
Gift of Clark Prestia

Remington Rand, Remington Portable Typewriter (X147.82)
Gift of Clark Prestia

Remington Rand, Remington Standard Typewriter, No. 6 (X159.82)
Gift of Clark Prestia

Remington Rand, UNIVAC Card Punch (X34.81)
Gift of National Museum of Science and Technology, Ottawa

Rheinische Metallwaren & Maschinenfabrik, Rheinmetall Typewriter (X151.82)
Gift of Clark Prestia

Royal Typewriter Company, Royal Typewriter (X140.82)
Gift of Clark Prestia

Royal Typewriter Company, Royal No. 5 (X143.82)
Gift of Clark Prestia

Telegraphen-Bau-Anstalt von Siemens and Halske, Needle Telegraph (X19.81)
Loan from Siemens Corporation

Signal Electric Manufacturing Company, "Signal Telegraph instrument" (B164.81)
Gift of Gordon and Gwen Bell

L.C. Smith and Bros., Typewriter Model No. 5 (X141.82)
Gift of Clark Prestia

Smith Premier, The Smith Premier Typewriter Model 10 (X139.82)
Gift of Clark Prestia

Teletype Corporation, Model 19 Teletypewriter (XD159.80)
Gift of Dick Eckhouse

Texas Instruments, Speak and Spell (X122.82)
Gift of Gene Frantz and W.R. Hawkins

Triadex Inc., "The Muse" (XD254.81)
Gift of Ed Fredkin

Underwood Typewriter Company, Standard Portable Typewriter (X153.82)
Gift of Clark Prestia

Underwood Typewriter Company, Underwood No. 12 (X157.82)
Gift of Clark Prestia

Versatec, Model 800 Printer/Plotter (X163.83)
Gift of Xerox Corporation

Western Electric, Telephone (X32.81)
Gift of Daniel Rizzo

Western Electric, Telephone (X56.80)
Gift of James Parker

Weston Electrical Instrument Corporation, DC Voltmeter (X125.82)
Gift of Carl Klempner

Weston Electrical Instrument Corporation, Portable Wattmeter (X126.82)
Gift of Carl Klempner

Yost Typewriter Company Ltd., Typewriter (X138.82)
Gift of Clark Prestia

Calculators, other than the manual bead devices, did not develop until the nineteenth century and have been virtually displaced by computers. Fundamentally calculators are defined as data operators carrying out arithmetic operations. Either calculators have become embedded in computers or miniaturized computers have been embedded in what have traditionally been considered calculators.

The Gilson circular slide rule was used for logarithmic calculations. It is one of several devices donated to the calculator collection by Thomas McIntyre.



- Abacus (B93.80)
Gift of Gordon and Gwen Bell
- ADDI-COSMOS, "B. U. G. Calculator" (B131.80)
Loan from Gordon and Gwen Bell
- Aeroproducts Research, Inc., Flight Plan Calculator (X55.82)
Loan from Steve Kallis
- R. C. Allen, "ARITHMA" (XD125.80)
Gift of Arthur Hall III
- American Can Company, "American Adding Machine" (B180.81)
Gift of Gordon and Gwen Bell
- Anita, Electronic Calculator (XD209.80)
Gift of Leonard Woodall
- Atanasoff-Berry Computer Breadboard (X12.80)
Loan from John Vincent Atanasoff
- Automatic Adding Machine Company, "Golden Gem Adding Machine" (X2.81)
Gift of Erwin Tomash
- Bell Telephone Laboratories Calculator, prototype adder reproduced by George Stibitz (XD127.80)
Gift of George Stibitz
- Bohn Contex, Desk Calculator (X43.81)
Gift of Bob Olthoff
- Brical Pocket Adding Machine (X13.80)
Loan from Dick Rubinstein
- Burroughs Corporation, Mechanical Biller Series M (X120.82)
Gift of Cosmopolitan Manufacturing Corporation
- "Circular Concise Slide Rule" (B114.80)
Gift of Gordon and Gwen Bell
- Clary Corporation, Clary DE600 (X35.81)
Gift of Lee McKusick
- Colossus Narrow Tape Pulley (X49.81)
Gift of Tobby Harper
- Contina Ag Mauren, "Curta" (B87.79)
Gift of Brian Randell
- Contina AG Mauren, Curta Calculator (X104.82)
Gift of Robert Bickford
- Drawing Instruments ca 1850 (B106.80)
Loan from Gordon and Gwen Bell
- Dring and Fage, Inland Revenue Slide Rule (B55.80)
Loan from Gordon and Gwen Bell
- Dring and Fage, "Leadbetter Slide Rule" (B108.80)
Gift of Gordon and Gwen Bell
- Hans W. Egli, "Millionaire" (B1.75); (B136.81)
Loan from Gordon and Gwen Bell
- Hans W. Egli, "Millipnaire" (B91.76)
Gift of Gordon and Gwen Bell
- "EXACTUS" (B36.79)
Gift of Gordon and Gwen Bell
- Fowler and Company, "Fowler's Textile Calculator" (B112.80)
Loan from Gordon and Gwen Bell
- Fowler and Company, Fowler's Universal Calculator (X172.83)
Gift of Thomas McIntyre
- J.F. Fuller, "Palmer's Improved by Fuller Computing Scale" (B110.80)
Gift of Gordon and Gwen Bell
- J.F. Fuller, "Palmer's Improved by Fuller Computing Scale" (X1.81)
Gift of Erwin Tomash
- General Precision Systems, General Purpose Analog Computer (X42.79)
Gift of Lincoln-Sudbury Regional High School
- Gilson Slide Rule Company, Trigonometric Slide Rule (X131.82)
Gift of Stanton Vanderbilt
- Gilson Slide Rule Company, Circular Slide Rule (X174.83)
Gift of Thomas McIntyre
- Gunter Rule (B41.79)
Gift of Gordon and Gwen Bell
- Gunter Rule (B4.76)
Loan from Gordon and Gwen Bell
- H. C., Calculigraphe (X173.83)
Gift of Thomas McIntyre
- Halden, "Calculex" Patent Circular Slide Rule (X171.83)
Gift of Thomas McIntyre
- Hewlett-Packard, "HP-35" (B34.79)
Gift of Gordon and Gwen Bell
- Hewlett-Packard, 9100A Calculator (X83.82)
Gift of Clyde Still
- The Hollerith Electric Tabulating System, Reproduction by Roberto Guatelli (D231.81)
Gift of Digital Equipment Corporation
- Jacquard Loom Mechanism (B117.80)
Loan from Gordon and Gwen Bell
- Keuffel & Esser, Slide Rule (XD50.76)
Gift of Dick Clayton
- Keuffel & Esser, Slide Rule (X170.83)
Gift of Thomas McIntyre.
- Keuffel & Esser, "Thacher's Calculating Instrument" (B56.80)
Loan from Gordon and Gwen Bell
- C & E Layton, "Tates Arithmometer" (B82.80)
Loan from Gordon and Gwen Bell
- Lewis & Tylor, Ltd., "Hydracalculator" (B113.80)
Gift of Gordon and Gwen Bell



Manufactured by J. Halden and Company, London, during the 1920's, the pocket watch style calculator and slide rule has two logarithmic scales, A and B, on one side for multiplication, division and proportion which correspond to the A and B scales of an ordinary slide rule. Around the outer edge is a scale of logarithms read by a cursor. The inner circles contain a scale of square roots. The other side of the Calculex contains A and B scales for inverse proportions. Gift of Thomas McIntyre.

D.H. Lehmer, Photoelectric Number Sieve (X85.82)
Gift of D.H. Lehmer

D.H. Lehmer, Berkeley Number Sieve (X86.82)
Gift of D.H. Lehmer

D.H. Lehmer, Film Number Sieve (X87.82)
Gift of D.H. Lehmer

L.I.D., Timber Calculating Slide Rule (B30.77)
Loan from Gordon and Gwen Bell

The Lightning Calculator Company, Lightning Calculator (X175.83)
Gift of Thomas McIntyre

Lightning Portable Adding Machine from the desk of George Forsythe (X15.81)
Gift of Gio C.M. Wiederhold

Marchant Electric Calculator (XD235.81)
Gift of Robert Floyd

Monroe, Desk Calculator (X90.82)
Gift of Gordon Osborne

National Radio Communication Slide Rule (X133.82)
Gift of Stanton Vanderbilt

Navigator's Gunter Rule (B54.80)
Loan from Gordon and Gwen Bell

Navigator's Sector (B21.78)
Loan from Gordon and Gwen Bell

Ohmite Manufacturing Company, Ohm's Law Calculator (X134.82)
Gift of Stanton Vanderbilt

Aaron Palmer, "Palmer's Pocket Scale" (B194.81)
Loan from Gordon and Gwen Bell

Pascal Adder, Reproduction by Roberto Guatelli (B150.81)
Loan from Gordon and Gwen Bell

Pickett and Eckel, Inc., Slide Rule (X121.82)
Gift of Lynn Yarbrough

Frederick Post Company, "Versalog Slide Rule" (X47.81)
Gift of Cliff Haten Jr.

Powers Samas Card Processing System (XD14.81)
Gift of the Biological Research Centre, Institute of Terrestrial Ecology

Precision Adding Machine Company, Inc., "Quixsum Adding Machine Model C" (B38.79)
Loan from Gordon and Gwen Bell

RCA Manufacturing Company, Decibel Slide Rule (X132.82)
Gift of Stanton Vanderbilt

Raytheon, Hawk Missile Auto Pilot (XD144.80)
Gift of Joe Kuprevich

Reliable Typewriter & Adding Machine Corporation, "Addometer" (B85.79)
Gift of Gordon and Gwen Bell

J. Sang, "Platometer" (B6.76)
Loan from Gordon and Gwen Bell

Selective Educational Equipment Corporation, "SEE CALCULATOR" (B31.79)

Servo Calculator Company, "Direct Reading Frequency Response Slide Rule" (X3.81)
Gift of Jack Worlton

Sharp Corporation, Electronic Printing Desk Calculator (X101.82)
Gift of Nicolas Johnson and Martin Harrison

Stanley Rule & Level Company, Timber Slide Rule (B99.80)
Gift of Gordon and Gwen Bell

M. Thomas de Colmar, "Arithmometer" (B3.76)
Gift of Gordon and Gwen Bell

M. Thomas de Colmar, "Instruction pour se servir de l'Arithmometre Machine à Calculer" (X4.81)
Gift of Erwin Tomash

J. Thomlinson, Ltd., "Thomlinson's Equivalent Paper Slide Rule" (B107.80)
Gift of Gordon and Gwen Bell

Texas Instruments, Slide Rule Calculator (XD237.81)
Gift of Mike Riggle

Tinker Toy Computer (X39.81)
Gift of Danny Hillis, Brian Silverman and friends

Wolverine Supply and Manufacturing Company, "Adding Machine" (B167.81)
Gift of Gordon and Gwen Bell

Memory is probably the oldest class in the computing classification system, starting with early markings on caves and continuing as a significant part of computers and automata. The ability of machines to either write or read on memory is the primary distinction separating these devices.



The first mass storage devices used commercially in the Univac were oxide-coated metallic tapes with two recording density modes. As a buffered system the tape could read forward and backward at speeds comparable to more recent tape systems. Two hundred bits per inch was the linear density on each of seven tracks used simultaneously. Data are organized into 60-word blocks. Each word has twelve decimal digits, each of these having seven bits. The tape, displayed in the Four Generations gallery, is a gift of Lawrence Livermore Laboratories.

The RCA Selective Electrostatic Storage Tube, used in the JOHNNIAC as a primary memory device, was developed for high speed registry and read-out of digital information. Its storage capacity was 256 signals. J. Rajchman's article in the RCA Review of 1951 states that "The storage is obtained by two stable potentials which tiny floating metallic elements, located in the register with the windows, assume under continuous electron bombardment. The signal to be stored is applied by capacitive coupling to all elements and brings the selected one to the desired stable potential. The reading signals are sizeable electron currents passing through a hole in the storing elements under the control of the element's potential. A visual display of the stored information is obtained also." The tube, a gift of Keith Uncapher and Tom Ellis, will be added to the memory exhibit.



Ampex Corporation, 64K Core Memory Module (X135.82)
Gift of Rick Jevon

Ampex Corporation, Core Memory Planes (X118.82)
Gift of David Sager

Atanasoff-Berry Computer Memory Drum (X11.80)
Loan from Dr. Clair Maple

Autonetics, Minuteman Fixed Head Desk Memory (XD107.80)
Gift of Aron Insinga

Bryant Computer Products, RM-10 Drum (X51.82)
Gift of Nigel Webb

Bubble Memory System (D8.81)
Gift of Nick Warchol

Richard Stevens Burrington, "Handbook of Mathematical Tables and Formulas" (B44.79)
Gift of William B. Lehmann

CCD Memory Board (D7.81)
Gift of Nick Warchol

Chemical Rubber Publishing Company, "Handbook of Chemistry and Physics, 31st Edition" (B28.79)
Gift of Gordon and Gwen Bell

Computer Controls Corporation, Delay Line Memory/Logic Module (D108.80)

Control Data Corporation, CDC 38500 Cartridge (XD222.80)
Gift of Lawrence Livermore National Laboratory

Digital Equipment Corporation, Core Memory (D200.80); 18 mil Planar Memory (D198.80); Experimental Ferrite Memory Stack (D160.80); PDP-11 Planar Structured Core Memory (D241.80); 64K Byte Memory Module (D34.80); VAX SBI Memory Board (D164.80); VAX Star 64K MOS Memory Array (D165.80)
Gifts of Digital Equipment Corporation

Disk Drive Prototypes (X52.82)
Gift of Steve Lambert

The Emeloid Company, Inc., "Transmission Line Calculator" (X29.81)
Gift of Cliff Hafen Jr.

English Electric Company, Deuce Mercury Delay-line (XD3.75); Deuce Memory Drum (X65.82)
Gifts of Murray Allen, University of Sydney

Ferranti Ltd., Atlas I Fixed Memory (XD129.80); Atlas I Memory The Supervisor" (XD130.80)
Gift of Rutherford Laboratories

Ferranti Ltd., Magneto-strictive Delay-line (XD230.80)

Ferranti Ltd., Pegasus Short Acoustic Delay-line (X54.82); Williams Tube (X67.82)
Gifts of Computer Science Department, Manchester University

Ferroxcube Corporation of America, Ferroxcube Core Memory (D195.80)

FUJITSU Ltd., Hollerith Read Only Card Reader and Cards (XD74-5.79); Paper Tape for FACOM (XD76.79)
Gifts of FUJITSU Ltd.

Harvard University, Mark IV 64-bit Magnetic Shift Register (XD6.75)
Gift of Bob Trocchi

Hertrich Development Inc., RL01 Disk Drive Prototype (XD163.80)
Gift of Fred Hertrich

Honeywell Memory Sense Amplifier (X22.81)
Gift of Phil Goldman

Honeywell Plated Wire Memory (D114.80)

Charles Hutton, "Table of the Products and Numbers" (B2.76)
Loan from Gordon and Gwen Bell

International Business Machines Corporation, IBM 650 Drum (X179.83)
Gift of Timothy E. Leonard

International Business Machines Corporation, 2321 Data Cell Drive (X46.82); 2321 Data Strips (XD219.80); Data Cell (XD220.80); 1360 Photo-digital Storage System (XD221.80)
Gifts of Lawrence Livermore National Laboratory

Los Alamos Scientific Laboratory, MANIAC Electrostatic Memory and Williams Tube (XD214.80)
Gift of Los Alamos Scientific Laboratory

Mermod Freres, Piano Disk (XD136.80)
Gift of Marv Horovitz

MITTS, Altair 4K RAM Board (X7.80)
Gift of Ed Luwish

"Model Ready Reckoner" (X57.80)
Gift of McLaren Harris

Napier's Bones (B27.79)
Loan from Gordon and Gwen Bell

NASA Apollo Guidance Computer Read Only Rope Memory (XD115.76)
Gift of Albert Hopkins

National Physical Laboratory, Pilot ACE Long Delay Line Memory (X160.82)
Gift of Donald Davies, NPL

G.A. Philbrick Researchers, GAP/R Computer Tube (X91.82)
Gift of Thomas Turano. (9/82)

Phillips, Ferroxcube FFI (D204.80)

RCA, Core Memory Board (XD197.80)
Gift of Gary Papazian

RCA, Experimental Ferrite Core Memory (D161.80); Thin Film Memory (DI12.80); Non-destructive Read-out (D162.80)

RCA, Ferrite Core Memory Cube (D169.80)
Gift of Cliff Granger

RCA, JOHNNIAC Selection Tube (XD215.80)
Gift of John Postley

RCA, Selective Electrostatic Storage Tube (X168.83)
Gift of Keith Uncapher

Sperry Rand, Mated Film Memory Array (X93.82)
Gift of Ted Bonn

Sperry Univac, LARC Memory Plane (X94.82)
Gift of Ted Bonn

"Sumador China" (X10.80)
Gift of Jim Rogers

Ironix
Core Memory Test Equipment
(X183.83)
MIT Instrumentation Laboratory,
Apollo Memory Stack Module
(X183.83)
Gift of Boguslaw Frackiewicz

3M Corporation, Telex Disk (D80.80)
Gift of Don Sordillo

Univac, Metal Tape (X82.82)
Gift of Lawrence Livermore
Laboratories

University of Illinois, ILLIAC II 48-bit
Register, Mesa Transistor (XD120.80)
Gift of Los Alamos
Scientific Laboratory

Freiherm von Vega, Logarithmisch-
Trigonometrisches Handbuch
Gift of George Valley. (82.2)

The Computer Museum solicits material to add to our archives and library from various sources: donors of artifacts, who often have boxes of related documentation, libraries and associations cleaning out duplicated materials, and individual collectors. Study collection material is treated in the same manner Exhibit Collections acquisitions are—numbered and acknowledged, and made available for research. The collection is arranged by computer company, representing about 65, with manuals and documentation on the machines and components the Museum has managed to acquire over the years. Audio-visual material is collected with an eye to integrating it into our exhibits. Recent acquisitions to the Archives and Library are listed below.

Manuals and Documentation

Air Force Magazine reprint, "The Bombardier and His Bombsight," September, 1961.
Gift of Norden Systems. (83.9)

Ampex Corporation, 3DM—2000
Magnetic Core Memory System.
Gift of Rick Jevon. (82.3)

Association of Computing Machinery, *Journal of the ACM*, vol. 1, no. 1; ACM National Conference, 1962, Advance Program; ACM Roster of Members, 1957; Report to the ACM, First Glossary of Programming Terminology, 1954.
Gifts of Mary Hardell. (82.15);
Journals and Computing Reviews.
Gifts of Massachusetts Computer Associates, Inc. (83.1)

Aberdeen Proving Ground,
Reports from Ballistic Research
Laboratories.
Gift of Richard Clippinger. (82.13)

Bell Laboratories, "A History of
Engineering and Science in the
Bell System—Switching Technology
1925-1975." Prepared by A.E. Joel Jr.
and Technical Staff, Bell Telephone
Laboratories.
Gift of Bell Laboratories. (83.12)

Bendix Computer, G-15 Reports.
Gift of Ramon C. Scott.

Burroughs Corporation, Burroughs
E101 materials.
Gift of James Rogers. (82.4)

Computer Design Magazine 20th
Anniversary Issue, December 1982.
Gift of Bob Evans. (83.7)

Davies, Donald. Papers on digital
communications.
Gift of Donald Davies. (82.12)

Digital Equipment Corporation,
PDP-1 Operating Manuals, 1969-70,
Gift of Paul Karger. (83.16);
PDP-8 Manuals and
Documentation.
Gift of The MITRE Corporation.
(83.3);
PDP-8/L Manuals and
Documentation.
Gift of Robert G. Miller. (83.5)

Gilmore, John T. Jr. "The Digi-
graphic Display Program for the
DX-1 Computer System," Charles
W. Adams Associates, Inc.; "Oper-
ational Procedure on the Whirl-
wind Computer," Digital Computer
Laboratory, MIT; "The Photoelectric
Conversion Program," Project
Whirlwind Servomechanisms Lab-
oratory, MIT; "The Lincoln Writer"
(with R.E. Savell), MIT Lincoln
Laboratory. (83.13)

Honeywell Inc. Datamatic 1000
manuals.
Gift of Robert F. Trocchi. (82.10)

Institute of Electronic and Electrical
Engineers, Transactions.
Gifts of Massachusetts Computer
Associates, Inc. (83.1)

IBM, 610 and 1620 Manuals,
Programmer's Reference Manual
"FORTRAN, Automatic Coding
System for the IBM 704."
Gift of Ramon C. Scott.

International Business Machines
Corporation, Journal of Research
and Development.
Gifts of Massachusetts Computer
Associates, Inc. (83.1);
IBM 1130 Manuals and
Documentation.
Gift of John R. Richards. (83.2);
IBM 7030 Manuals and
Documentation.
Gift of Brigham Young University.
(83.6);
Operating and Maintenance
Manuals for IBM 402, 403, 409, 419,
1231, 1232.
Gifts of Michael Weisbard. (83.8)

350 Jahr Rechenmaschinen Vor-
trage eines Festkolloquiums.
Gift of Hermann Kassubek. (82.1)

Kartran 800 Manuals.
Gifts of Frank Feigin.

LGP-30 Floating Point Interpretive
System.
Gift of Ron Ginger. (82.9)

Massachusetts Institute of Technol-
ogy, Department of Civil Engineer-
ing, "Engineer's Guide to ICES
COGO I", 1967.
Gift of Mary Hardell. (82.15);
"How the SAGE Development
Began".
Gift of George Valley. (83.15);
SAGE Press Kit, June 1958.
Gift of Ed Townsend. (82.6);
Whirlwind I Computer Report
R-127, September 1947.
Gift of Tim Leonard. (83.14)

Norden Systems, "PDP-11/34M,
A Fully Militarized Computer."
Gift of Norden Systems. (83.9)

RCA Review, March 1951, Vol. XII,
No. 1, reprint: "The Selective
Electrostatic Storage Tube" by
J. Rajchman.
Gift of Tom Ellis and Keith
Uncapher. (83.11)

Rand Corporation, JOSS Manuals
and Documentation.
Gift of Willis H. Ware. (83.17)

Remington Rand Inc. "Program-
ming Univac Systems: Instruction
Manual I", 1953.
Gift of David V. Cossey. (83.10)

Sperry Rand Corporation,
UNIVAC DAS Documentation.
Gift of Ramon C. Scott.

Texas Instruments, Inc. Advanced
Scientific Computer Manuals and
Documentation.
Gift of Texas Instruments. (83.4)

Theory of Operation of Display
System for AN/ESQ-7 Combat
Direction Control.
Gift of the MITRE Corporation
Archives. (82.8)

Audio-Visual Material

Robert Bonifield, photographs of
D.H. Lehmer's number sieves.
Gift of Robert Bonifield. (82.7)

Burroughs E101, original photo-
graphs.
Gifts of Bill Smith.

The Computer Era Calendar,
original photographs.
Gifts of Dick Eckhouse and Ruth
Mauhucci. (82.5)

IBM, Photos of System 360.
Gift of Ramon C. Scott.

International Research Conference
on the History of Computing, Audio
and video tapes, volumes.
Gift of William F. Luebbert. (82.14)

Johnniac Computer, original
photographs.
Gifts of Keith Uncapher and
Tom Ellis. (83.11)

RCA, Photos of BIZMAC, 301, 501.
Gift of Ramon C. Scott.

Sperry, Photos of Univac 9400.
Gift of Ramon C. Scott.





Charles Bashe (second from left), who occupied an office across from Gene Amdahl (left) during the design of the IBM 701 and 704, came for Gene Amdahl's lecture and is joined by Maurice Wilkes (second from right) and Charles Bachman (right).

Oliver Selfridge's talk on the past and future of Artificial intelligence attracted over 150 people to the first "Bits and Bites" program of the Spring season.

Exhibits, by virtue of the themes they represent, the artifacts they exhibit, and the scholarship necessary to both, are The Computer Museum's most eloquent form of communication. But in order for an exhibit to communicate its message, it must have an audience that not only receives and benefits from the message, but who ultimately become advocates for the Museum. Special programming, developed to complement exhibits and archives, plays a special role. The Museum's Lecture Series, "Bits and Bites", symposia, excursions, and special events like the Babbage play, reflect or amplify exhibits and actively promote the Museum in its role as the world's only Museum dedicated to the preservation of computer history. They function as a conduit between the substantive areas of the collection, and the public's understanding of and access to those areas.

The past year at The Computer Museum has seen a number of parallel efforts designed to expand audiences and increase visibility. The six major lectures are the most prominent of these. These lectures focus upon significant machines, applications, languages or contributors. In the past year, The Computer Museum has sponsored lectures by Derreck Lehmer on The History of the Sieve Machines, Herbert Grosch about work done at the Watson Scientific Laboratory from 1945-50, Harry Huskey on the Pilot ACE to the G-15, Gene Amdahl, and Captain Grace Hopper.

Not every presentation can have the import of a major lecture, but the sixteen "Bits and Bites" talks help present a balanced program on the history of computing by covering a wide variety of issues. Topics include everyday descriptions of computing, contemporary uses of computers in the arts, and the effect of cryptography on computing. From the first talks with thirty to forty people in attendance, they now average over 100 people per week—drawing a wide variety of interested participants.

Guided tours at The Computer Museum are another public educational program that made great strides in the past year. In an eight-month period, over 135 tours were scheduled, with one-third being organized by volunteers. With advanced booking and a fee of \$25.00, it is still possible to tailor the tour to the audience. The nature of a tour depends on the background of the group requesting the service—offering either deeper insights into specific exhibits or providing a brief overview of the collection. Guided tours, in effect, can be adapted to changing audiences or changing exhibits—something that the more high-tech forms of interpretation, such as personal cassette recorders, have difficulty doing.

As part of the effort to introduce the Museum to as many people as possible, we have also made the gallery and lecture space available to outside groups sponsoring meetings and functions. For instance, at a recent

meeting of the Worcester Chapter of the IEEE, a "film night" was arranged, featuring historic films in the Museum's collection. In addition, staff members were on hand to guide IEEE members through the collection and answer questions about exhibits and programs.

The Museum has supplemented these in-house programs with an outreach service. A mini-travelling exhibit was developed to take the Museum "on the road" to national conferences and trade shows and now reaches an even broader cross-section of audiences and markets. Digital's Educational Computer Systems Group made the first request for display and paid for the exhibit's design and construction.

In February, the ACM (Association for Computing Machinery) donated booth space to the Museum at a conference of 2,100 computer science educators from throughout the United States. Our involvement in the conference provided an opportunity for the Museum to make our slide and publication services known to educators. The "Computer Culture" Conference, organized by the New York Academy of Sciences, provided resources for the Museum to produce the film "Pioneer Computers in Operation: Historic Films of ENIAC, EDSAC, Whirlwind and the First Computer-written Western," and the opportunity for Gwen Bell to narrate and provide commentary. Participation in each of these conferences has benefitted the Muse-

Gene Amdahl speaking about his work on the WISC, Stretch, the Amdahl series, and the soon-to-be-released Trilogy computer.



um in terms of visibility within the computer community, increased membership, and in some cases, new acquisitions. At the same time the image and appeal of the conference is enhanced by the exhibits and or program participation of the Museum.

With over 70 books available (including computer history reference texts, children's books or lighter recreational reading), the Museum Store provides a convenient clearinghouse for information relating to books available on the history of computing. Out-of-press titles and rare books are frequently in stock for the benefit of



The Museum Store, with its ever-expanding inventory of books and computer memorabilia, attracts visitors every day.

researchers and bibliophiles alike. Antique calculating devices are available to collectors through the Store's fleamarket section and slide sets of the Museum's collection are excellent resources for the classroom.

The Museum's expanded repertoire of programs is a function of their popularity and effectiveness, as well as a function of the support of our volunteers. It would simply be impossible to organize these efforts without additional assistance in these areas. To that end, local members meet quarterly to help the staff with ideas and react to proposals. Kitty Selfridge, Chairperson, and Ed Galvin, Secretary, organize and record suggestions for programs, store products, and development of volunteer activities.

Increased press coverage has been created or inspired by program activities. Since June, major features on the Museum have appeared in over twenty publications including the November *OMNI*, and February *Discover* magazines, plus various computer publications. These, in turn, have generated further visibility through television and radio coverage. This media attention has been both national and international: live radio interviews have been carried on by telephone to Spokane, Louisville, Chicago, and even the BBC in Manchester. The Museum was featured on Boston's *Evening Magazine* and the Museum provided materials for the Grace Hopper interview on the 60 Minutes program.

More is planned for the future; we are already planning for a full schedule of programs this fall. Lecture speakers are being finalized, a preliminary "Bits and Bites" roster has been established and an itinerary of convention shows is being organized for the travelling exhibit. And, as in the past, all programs will be designed to complement our ever-growing slate of exhibit activities.

Christine Rudomin
Programs Coordinator

The Computer Museum Store supports the Museum exhibits by offering books that further explain the history of our exhibited machines. Our collection of books, and videotaped lectures, provide a great opportunity for Museum visitors who desire to know more than can be recorded in a single text panel. The books range in presentation from highly technical to purely recreational. The Museum store is open to suggestions for new books that will interest the Computer Museum audience.

Illiac IV, by R. Michael Hord, 1982, Computer Science Press, Rockville, 350 pp. Order: HOR82 \$29.95 (members \$26.95)

"The Illiac IV—conceived as a massive breakthrough in computer technology—succeeded so well that it defined a new category of processors and gave rise to the term 'supercomputer.' Both the computer professional and the educated layman will share the sense of majesty in the recounting of this exciting project." *Computer Science Press*

Hut Six, by Gordon Welchman, 1982, McGraw-Hill Book Company, New York, 326 pp. Order: WEL82 \$12.95 (members \$11.65)

"A fascinating account of the breaking of the German 'Enigma' code which took place at Bletchley Park in England. The author was deeply involved in the cryptanalysis project, and thus presents a very personal history of the events leading up to the codebreaking. The book offers an excellent insight into the personalities involved in the project. The last section of the book is devoted to an analysis of the current state of the communications systems in the U.S. defense program, a scathing critique." *Ben Goldberg*

The Enigma War, by Jozef Garlinski, 1980, Scribner, New York, 211 pp. Order: GAR80 \$6.95 (members \$6.25)

"Historians of WW II and specialists in intelligence cryptanalysis will find Garlinski's study indispensable; it is the most detailed, corroborated account of the development and perfection of the 'Enigma' machine by which the Allies were able to decipher a great portion of the strategically important Nazi and Japanese radio messages from 1940 onward." *Choice Magazine*

Early Scientific Instruments, by Nigel Hawkes, 1981, Abbeville Press, Inc., New York, 73 full page color illustrations, 164 pp.

Order: HAW81 \$35.00 (members \$31.50)

"In this book are illustrated important examples from the diverse range of artifacts with which man has tried to discover and explain the complexities of the physical world, and, through this comprehension, use nature for his own ends. These early instruments, in addition to providing a tangible record of the development of scientific knowledge, vividly demonstrate the technical ingenuity of former times." *D.J. Bryden in the Introduction*

Antique Scientific Instruments, by Gerard L'E Turner, 1980, Blanford Press Ltd., Dorset, 69 color plates, 168 pp.

Order: TUR80s \$7.50 (members \$6.75)

"The author, Senior Assistant Curator of the Museum of the History of Science, Oxford University, has collected his illustrations and materials from a variety of European museums and collections. The first four chapters on astronomy and time-telling, navigational instruments, surveying instruments, and drawing and calculation instruments are particularly relevant to the pre-history of computers. The last chapter, 'Practical Advice on Collecting,' will be especially useful to collectors." *Gwen Bell*

Early British Computers: The Story of Vintage Computers and the People Who Built Them, by Simon Lavington, 1980, Digital Press, Bedford, fully illustrated, appendix, 139 pp.

Order: LAV80 \$9.00 (members \$8.10)

"This volume, sprinkled with more than 60 photographs, discusses wartime work on Colossus, EDSAC, Pilot ACE, the Manchester Mark I, LEO, and other early British computers." *Henry S. Tropp, Annals of the History of Computing*

Project Whirlwind: The History of a Pioneer Computer, by Kent C. Redmond and Thomas M. Smith, 1980, Digital Press, Bedford, 67 illustrations and diagrams, 280 pp.

Order: RED80 \$25.00 (members \$22.50)

"This book is not a technical engineering account. Instead, it is an attempt to reconstruct the complexity of technical, financial, and administrative problems and the eventual compromises and solutions to these problems." *Henry S. Tropp, Annals of the History of Computing*

A History of Manchester Computers, by Simon Lavington, 1975, National Computing Centre, Manchester, England, fully illustrated, 44 pp.

Order: LAV75 \$6.50 (members \$5.85)

"This very useful booklet summarizes the history of five successive computer projects at Manchester University, during the period 1946-1975. The early pages give information, from primary sources, on the development of the first computer at Manchester, and on the roles of F.C. Williams, T. Kilburn, M.H.A. Newman, A. Turing, and others. Profusely illustrated." *Brian Randell*

The Origins of Digital Computers: Selected Papers, edited by Brian Randell, 1975, Berlin, Springer, 580 pp.

Order: RAN75 \$35.00 (members \$31.50)

"An outstanding collection of excerpts from important nineteenth and twentieth century computer developments, together with background and commentary on each excerpt." *William Aspray*

A History of Computing in the Twentieth Century, edited by N. Metropolis, J. Howlett and Gian-Carlo Rota, 1976, Academic Press, Inc., New York, 121 illustrations and photos, 659 pp.

Order: MET76 \$29.50 (members \$26.55)

"If you've been thinking that some day you should read something on computer history, buy this book! It consists of edited versions of papers presented in 1976 at an invitational conference supported by the Los Alamos Scientific Laboratory and by the National Science Foundation. The authors of the 37 papers include a high percentage of the people who personally did the pioneering work in computing or were firsthand witnesses to it." *D.D. McCracken, Computing Reviews*

Origins of Modern Calculating Machines, by J.A.V. Turck, 1972, Arno Press Inc., New York, 38 illustrations, 196 pp. Order: TUR72 \$19.00 (members \$17.10)

"This book is a chronicle of the evolution of mechanical calculating and recording machines including machines such as Pascal's adding machine, the Comptometer, the Burrough's machine and the Billing's machine. Written in 1921, the book is of historical interest for its unique perspective, its extreme detail and excellent illustrations." *Allison Stelling*

Order from The Computer Museum Store, One Iron Way, Marlboro, Massachusetts

The Founders Program

Corporate Founders

Association for Computing Machinery
Benton and Bowles
Leo L. Beranek and Newman
Color Labs
British Computer Society
Robert Cipriani Associates
Clint Clemens
ComputerWorld
Control Data Corporation
Convergent Technologies
Coopers and Lybrand, Boston
Data General
Dataproducts Corporation
Digital Equipment Corporation
General Systems Group, Inc.
Ford Motor Company
Fujitsu Limited
IEEE Computer Society
Intel Corporation
International Telephone and
Telegraph Corporation
MDB Systems, Incorporated
MITRE Corporation
OMNI Publications International, Ltd.
Richard Reno
Schlumberger Foundation
Seldin Publishing
Software Results Corporation
Tobin Vending Service
Wang Laboratories

Individual Founders

Charles W. Adams
Gene M. Amdahl
Michael and Merry Andelman
Harlan E. and Lois Anderson
John Atanasoff
Isaac L. Auerbach
Charles and Constance Bachman
John Banning
Harut Barsamian
G.C. Belden, Jr.
Gordon and Gwen Bell
James and Roberta Bell
Chester Bell
J. Weldon Bellville
Leo L. Beranek
Alfred M. Bertocchi
Erich Bloch
Ted Bonn
David H. Brandin
Richard A. Brockelman
Gordon S. Brown
Lawrence C. Brown
Arthur and Alice Burks
James R. Burley
Roger C. Cady
Philip and Betsey Caldwell
George A. Chamberlain III
George Champine
Reginald and Linore Cleveland
Harold Cohen
Charles W. Conn
Harvey Cragon
Henry J. Crouse
James G. Cudmore
Amos R.L. Deacon, Jr.
Harvey and Barbara Deitel
William R. Demmer
Ed de Castro
Arnaud de Vitry
Richard Dickerman
Lloyd I. Dickman
Henri G. Doll
Patrick M. Donini
Georgedna Doriot
J. Alvin Dru'yor
Sanford H. Duryee
Richard Eckhouse
David B. Edwards
Tom Eggers
M. Gordon Ehrlich
Dan L. Eisner
John H. Esbin
Ulf and Helene Fagerquist
Edward Alvin Feustel
Jay W. Forrester
Ed Fredkin
Neil Freeman
Alan E. Frisbie
Samuel H. Fuller
Bernard A. Galler
Bruce Gilchrist
John T. Gilmore Jr.
Robert Glorioso
Philip Goembel
Bernard M. Gordon
Herbert R.J. Grosch
Sheila Grinnell
Brian and Marie
Gruzinov-Henderson
Roberto A. Guatelli
Richard H. Gumpertz
Jerrier A. Haddad
W.M. Hall
Lewis H. Halprin
J. Scott Hamilton
William Heffner
Margaret A. Herrick
Winston R. Hindle, Jr.
Peter S. Hirshberg
Robert B. Hoffman
C. Lester Hogan
Grace M. Hopper
Christoph Horstmann
M. Ernest Huber
A.L.C. Humphreys
Harry Huskey
Richard I. Hustvedt
Robert A. Iannucci
L.R. Jasper
Theodore G. and Ruth T. Johnson
John Allen Jones
Allen Kent
Jack S. Kilby
John Kirk
Martin Kirkpatrick
David C. Knoll
Andy Knowles
David J.A. Koogler
Alan Kotok
Edward A. Kramer
Kaneyuki Kurokawa
R.L. Lane
Bud Lawson
Les Lazar
John V. Levy
Robert C. Lieberman
William H. Long
Theodore C.M. Lo.
William F. Luebbert
Tsugio Makimoto
Richard D. Mallery
Ruth Maulucci
Franklin N. Mann
Julius L. Marcus
Tom Marill
Pamela McCorduck
Daniel D. McCracken
Patrick J. McGovern
Thomas W. McIntyre
James L. McKenney
William and Vesta McLean
John E. McNamara
Thomas and Elizabeth McWilliams
Carver A. Mead
Robert M. Metcalfe
Matthew Miau
Harold T. Miller
Richard G. Mills
Gordon E. Moore
John Morrissey
J. Craig Mudge
Albert E. Mullin, Jr.
David Murphy
Susannah and Nigel Nathan
Lee J. Neal
Gregory L. Nelson
Joseph M. Newcomer
Walter I. Nissen, Jr.

Jeremy M. Norman
Bob Noyce
H. Edward Nyce
Kenneth H. Olsen
Robert K. Otnes
John Ousterhout
Martin J. O'Donnell
Louis Padulo
Ted C. Park
Jean-Claude Peterschmitt
J. Eric Pollack
William G. Pomeroy
James N. Porter
Jonathan Postel
Robert M. Price
Robert W. Puffer III
Henry W. Ramsey
Brian Randell
Robert W. Rector
Brian and Loretta Reid
Ronald Resch
Fontaine K. Richardson
C. Mike Riggie
Michael Rooney
Jack Roseman
Dorothy E. Rowe
Martin I. Sack
Michael J. Samek
Jean E. Sammet
F. Grant Saviers
Edward A. Schwartz
Oliver G. and Kitty Selfridge
Donald G. Seydel
John J. Shields III
John F. Shoch
Alan F. Shugart
Jonathan Singer
Richard L. Sites
Ronald G. Smart
John F. Smith
Steven Spellman
John Stark
Gerald Steinback
Max J. Steinmann
David K. Stevenson
Robert E. and Diane M. Stewart
George Stibitz
William D. and Carole K. Strecker
Thomas A. Susic
Ivan and Marcia Sutherland
Stephen A. Szygenda
David Tarabar
John Tartar
Robert W. Taylor
Norman H. Taylor
William R. Thompson
James E. Thornton
Erwin Tomash
Michael G. Tomicic
Fritz and Nomi Trapnell
Jacqueline Tyrwhitt
George E. Valley, Jr.
D.V.R. Vital
An Wang
W. Joe Watson
Thomas E. Welmers
J.B. Wiesner
Harvey W. Wiggins, Jr.
William Wolfson
Leonard W. Woodall
James W. Woods
Richard H. Yen

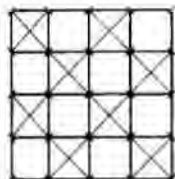

During the initial two-year period of the Museum, until June 10, 1984, the Founders Program is in effect. The purpose is to build a strong foundation for The Computer Museum. This provides participants with a unique opportunity to help The Computer Museum become established as an industry-wide Museum that will have enough support to continue its efforts to preserve the history of information processing.

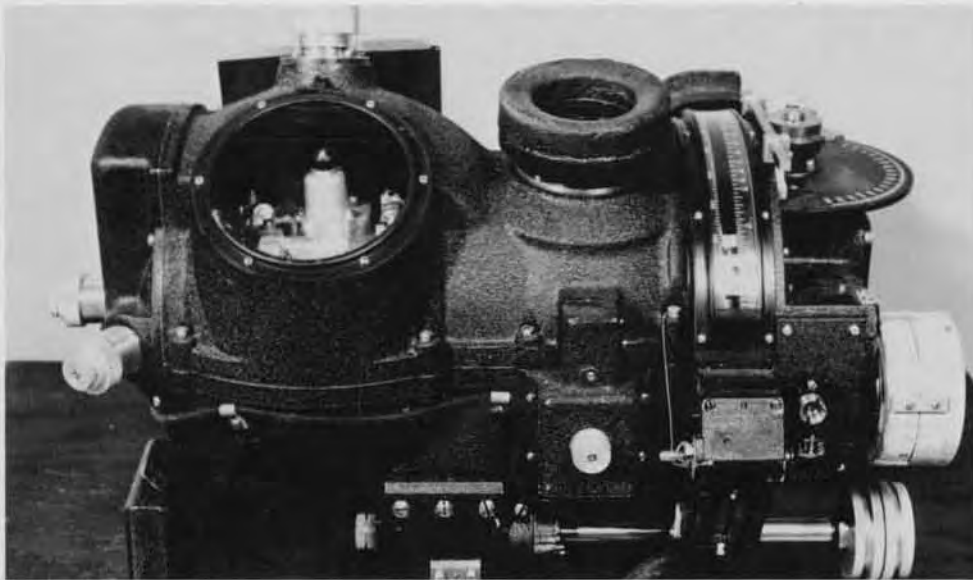

The Norden Bombsight became famous during World War II for making bombing uncannily precise—it could place a bomb inside a 100-foot circle from four miles up. Bombardiers said that it could put a bomb in a pickle barrel from 20,000 feet. When asked to verify this information,

inventor Carl L. Norden replied: "Which pickle would you like to hit?" By the end of the war, more than 25,000 bombsights had been built by Norden and more by Sperry, each costing \$25,000. The Computer Museum's bombsight is a gift of Norden Systems.

The Computer Museum

One Iron Way
Marlboro
Massachusetts
01752

Non-Profit
Organization
U.S. Postage
PAID
Marlboro, MA
Permit No. 46

THE COMPUTER MUSEUM REPORT

FALL 1983

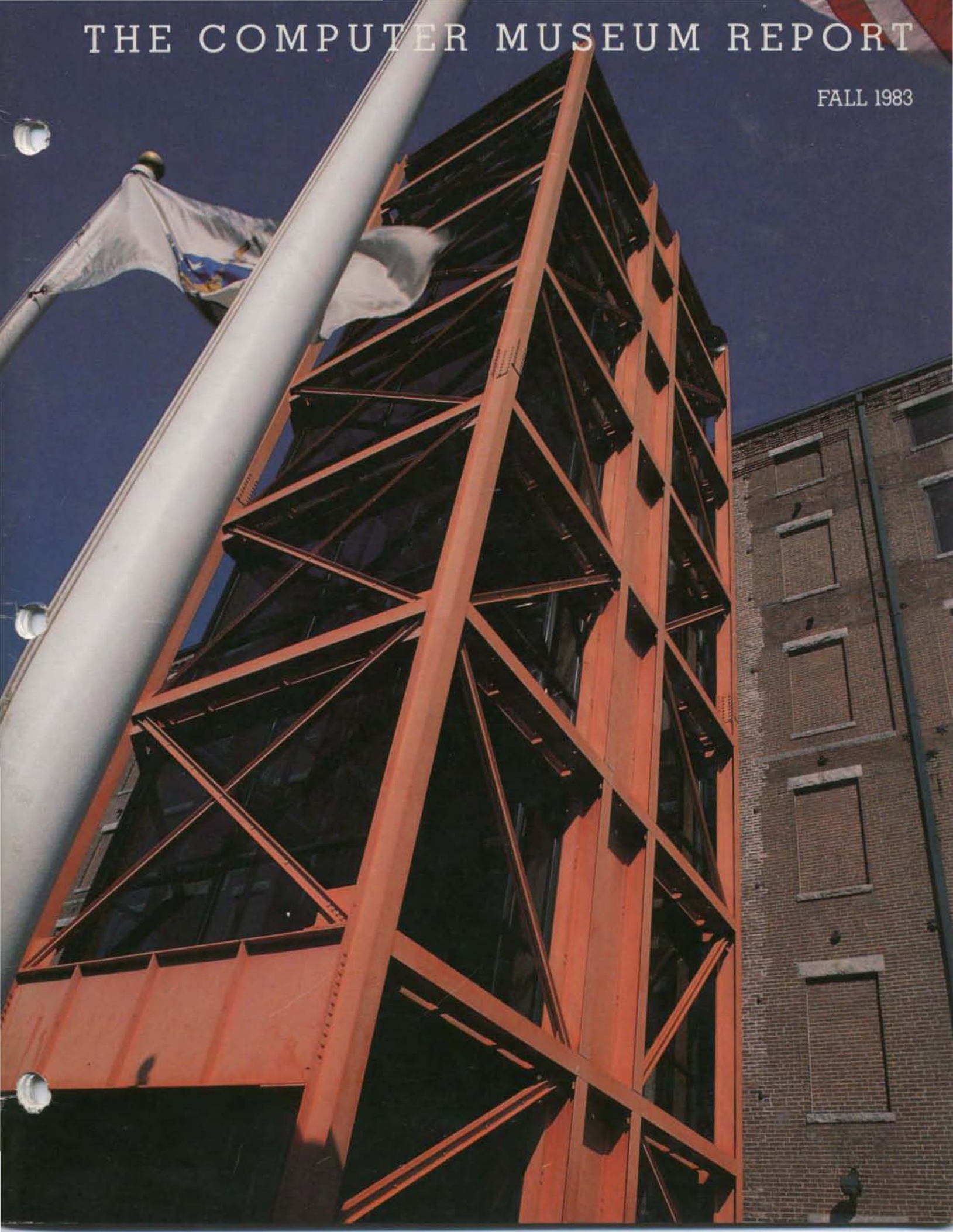

Contents

- 1 The Director's Letter
- 3 The Archiving Symposium
- 5 The Museum's Video and Film Collection
- 6 Spacewar!
- 13 Univac Tape
- 14 Spring Events
 - Grace Hopper Lecture
 - First Anniversary Dinner
 - Apollo Guidance Computer Talk
- 17 Pray, Mr. Babbage. . . .
Maurice Wilkes
- 24 Founders
 - Fall 'Bits and Bites' Schedule
 - The End Bit



THE COMPUTER MUSEUM

The Computer Museum is a non-profit, public, charitable foundation dedicated to preserving and exhibiting an industry-wide, broad-based collection of the history of information processing. Computer history is interpreted through exhibits, publications, videotapes, lectures, educational programs, and other programs. The Museum archives both artifacts and documentation and makes the materials available for scholarly use.

The Computer Museum is open to the public Sunday through Friday from 1:00 to 6:00 pm. There is no charge for admission. The Museum's lecture hall and reception facilities are available for rent on a prearranged basis. For information call 617-467-4443.

Museum membership is available to individuals and non-profit organizations for \$25 annually and to businesses for \$125 annually. Members receive the quarterly Report, invitations to all lectures and special programs, new posters, and a ten percent discount in the Museum store.

A Founders program is in effect during the initial two-year period of the Museum, until June 10, 1984. During this period individuals and non-profit organizations may become Founders for \$250 and businesses and charitable Foundations may become Founders for \$2500. Founders receive all benefits of membership and recognition for their important role in establishing the Museum.

THE COMPUTER MUSEUM REPORT (ISSN 0736-5438)

The Computer Museum Report is published quarterly by The Computer Museum, One Iron Way, Marlboro, MA 01752. Annual subscription is part of the membership of the Museum (\$25 per year for individuals and nonprofit organizations and \$125 for corporations).

The purpose is to report on the programs and exhibitions of the Museum. The contents of The Computer Museum Report may not be reproduced without written consent.

The Museum Staff is responsible for the contents of the Report. The opinions expressed do not necessarily represent those of The Computer Museum or its Board of Directors.

The design and production of the Report is done by Benson and Clemons.

STAFF

Director
Gwen Bell

Administration
Geri Rogers, Coordinator
Eileen Gardner
Lester Schwartz

Communications
Stephanie Haack, Coordinator

Exhibits and Archives
Jamie Parker, Coordinator
John McKenzie
Bill Meany
Beth Parkhurst
Meredith Stelling
Gregory Welch

Programs
Christine Rudomin, Coordinator

Store
Carol Strecker, Coordinator
Sally Askins
Alison Christie
Linda Davidson
Merle Insigna

BOARD OF DIRECTORS

Kenneth H. Olsen, Chairman
Digital Equipment Corporation

Charles W. Bachman,
Chairman, Executive Committee
Bachman Information Systems

C. Gordon Bell
Encore Computer Corporation

Gwen Bell
The Computer Museum

Erich Bloch
International Business Machines

Harvey D. Cragon
Texas Instruments

David Donaldson
Ropes and Grey

Robert Everett
The MITRE Corporation

Sydney Fernbach
Computer Consultant

C. Lester Hogan
Fairchild Camera and Instrument Corporation

Theodore G. Johnson
Digital Equipment Corporation

Andrew C. Knowles III
Digital Equipment Corporation

John Lacey
Control Data Corporation

Pat McGovern
ComputerWorld

James McKenney
Harvard Business School

George Michael
Lawrence Livermore Laboratories

Robert N. Noyce
Intel

Brian Randell
University of Newcastle-upon-Tyne

Jean E. Sammet
International Business Machines

Edward A. Schwartz
Digital Equipment Corporation

Kitty Selfridge,
Chairman, Members Committee
Henco Software, Inc.

Michael Spock
The Children's Museum of Boston

Erwin Tomash
Dataproducts

Honorable Paul E. Tsongas
U.S. Senator, Massachusetts

The Computer Museum
One Iron Way
Marlboro, Massachusetts 01752
617-467-4036

© 1983/THE COMPUTER MUSEUM

Photo Credits:

David Bromfield pp. 9, 13, 15, and cover

Pictured against a crystal-clear sky is the glass-enclosed elevator that will be the entry-way to The Computer Museum in its new location on Museum Wharf, Boston (see director's letter for more information on the move).

CBS, *The Thinking Machine* pp. 5

Shag Graetz pp. 6, 8, 10, 11, 12,

Steve Rosenthal pp. 1, 2

Carolyn Sweeney pp. 14, 15

Next fall, The Computer Museum should be operational in downtown Boston at Museum Wharf, a six story condominium for two museums. The Museum will occupy floors five and six. Visitors will enter The Computer Museum via the majestic elevator pictured on the cover. The decision to move was made quickly, but with care.

Last summer, just after we had opened our doors as a public museum, Michael Spock, Director of Boston's Children's Museum and member of The Computer Museum Board, called me and asked, "Would you consider moving to Museum Wharf?"

I retorted, "You've got to be kidding, we just opened in Marlboro." But the seed had been planted.

During the last year, the most common questions from visitors and members were: "In the long run, where do you think the Museum should be?" "How long do you think the Museum will stay in Marlboro?" To be able to respond to these, we evaluated alternative locations that would be convenient to our public: people from around the world interested in computers. Proximity to the airport, convention hotels and local universities were critical factors. The stumbling block was money. Unless a special opportunity arose, relocating would cost tens of millions of dollars and take years of planning.



In January, Mike called again and asked if the Museum would consider moving to the top two floors of Museum Wharf. I knew we should take him seriously, but I questioned the suitability of the Wharf space. Having just installed a 9,000 pound section of ILLIAC IV, I asked, "What's the loading capacity of the floor?"

He replied, "One hundred pounds per square foot."

"That's double our present loading capacity," I said. "But, how can we get a 12 x 8 x 4 foot machine to the top floors?"

"No problem," said Spock, "You can drive a fire engine into one end of the elevator and out the other onto the floor."

The location fit the criteria. The site has a canal-front park with a view of downtown Boston. It is minutes from the airport, a short walk from South Station and the "redline" subway that stops near MIT and Harvard, and is convenient to convention hotels. Also, BOSCOM, a permanent international computer marketcenter opening in late 1984 on Commonwealth Pier, is within walking distance.

Exhibit coordinator Jamie Parker and I made an appointment to see the space. The Museum of Transportation had recently moved out leaving a bare shell equipped to hold another museum. The sprinkler system, heating system and public facilities were all up to code. And the structure itself, built as a wool warehouse, had large generic spaces into which exhibits could be set. The Computer Museum could occupy 60,000 square feet, six times more space than it has in Marlboro. While The Computer Museum's goals indicate an eventual need for several hundred thousand square feet, Museum Wharf provides the appropriate next step.

But we did not let ourselves get excited. The Museum didn't have any funds to purchase the property and Mike Spock and the Board of The Children's Museum needed to have a rapid decision. I talked about the issue with Ken Olsen, Chairman of our Board. He in turn took the issue to

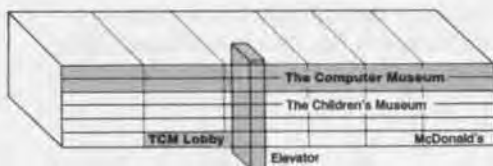

the officers of Digital Equipment Corporation. The consensus was that if the building provided good value for the Museum, and if enough support would be forthcoming, then it was appropriate to make the move. Digital had been happy to provide an incubator for the Museum, and would be proud to have it move to proper museum quarters at the right time.

Two studies were undertaken to test whether we should purchase one half interest in Museum Wharf. Digital's real estate department determined the value to be received was very high. For a down payment of \$1,200,000 and half interest in a \$1,600,000 Industrial Revenue Bond (at 8.5% interest to 1999), The Computer Museum will own half of a 155,000 square-foot building equipped as a museum. This is a third of the cost that most museums have to pay for similar space in similar locations. Simultaneously, Robert J. Corcoran Associates undertook a feasibility study to determine whether \$5 million could be raised for this project. After more than sixty interviews with industry leaders, they gave the project an unequivocal green light. The Board of Directors of The Computer Museum then agreed to undertake the necessary fundraising to enable this move.

Since then, the staffs of the two museums have met together and started to work on appropriate ways to share and cooperate as the owners of Museum Wharf.

The ground floor of the Wharf will be developed for public spaces. Both museums will have separate lobbies and separate museum shops, accessible to the public without entering the museums. MacDonaldis has a long term lease on the bay on one end of the building, and in the summertime "The Milk Bottle" is open as a refreshment stand.



The Children's Museum occupies floors two through four and is accessible by several interior stairways. Unlike many children's museums, it is both collection based and hands-on. The Americana, Native American, and Japanese collections provide the basis for exhibits, study and teacher resource material. The centerpiece of the Japanese collection is a recreated 16th century silk merchant's house from Kyoto. Visitors take off their shoes, sit on tamamis and listen to an interpreter tell about life in the house. The collections and study areas are housed in special climate-controlled areas beyond the house. The curatorial staff of The Children's Museum will help us understand how best to use the Wharf building for exhibits and the interrelation of study, collections and exhibitions—an important concept for The Computer Museum to develop.

This move will bring the Museum to a new threshold in developing exhibits. The members, many who act as "curators," have helped us acquire and interpret the exhibits, resulting in a technical presentation. After an exhibit is up, they comment and criticize, and we make changes. Many visitors at Museum Wharf will be laymen, so our exhibits must be more accurate from the start and must be layered from a general to a technical level. Because member input has been so valuable, the exhibits will open for members only as a field test. If all goes well, next May you will be invited to Museum Wharf to review the first exhibition. And with all that has happened in this past year, I'm betting on it.

Gwen Bell
Director

Symposium

The Computer Museum sponsored a two-day symposium in May on archiving issues in information processing history.

In only 35 years, the Information Revolution has produced more historical records on itself in more forms than those available about any previous scientific era.

Symposium attendees included archivists and others from The MITRE Corporation, Lawrence Livermore Laboratories, Travellers Insurance Company, the MIT Library and Museum, Elecitherian Mills Museum, Clark University, the Charles Babbage Institute, the Annals of the History of Computing, and the National Museum of Science and Technology, Canada.

"Criteria and taxonomies must be established for collections," said Helen Slotkin, archivist at MIT. "The first step is the general taxonomy of the field, such as that provided in Bell and Newell's *Computer Structures* and adopted by The Computer Museum. The second step is the decision of whether or not to save any particular document."

Slotkin emphasized that a "record" is a "record" independent of the field, and contemporary standard archival criteria for preservation may be used. But contemporary standards are different from those passed down from librarians in the days when everything could be saved, shelved and cataloged.

Gordon Bell and Jean Sammet, both authors of historical "trees," argued about the placement of limbs and branches and agreed that getting the tree planted was the significant point. A forest with a limited number of species for various major collecting areas would then give the overall picture.

The importance of different collections was also discussed. Arthur Norberg, director of the Charles Babbage Institute, described its focus on the early papers of the individuals who formed the industry, and hence the evolution of the information processing industry. Computer Museum archivists explained its collecting policy—The Museum starts with hardware and then collects the accompanying documentation. It was recognized that each institution would provide archives in keeping with its primary role. For ex-

ample, universities and company archives would be expected to be primary sources for the papers on people and activities primarily associated with them.

Computer historian Paul Ceruzzi made the case that although we need to see documents of all kinds, the artifacts themselves are also valuable. A movie or a set of prints just does not provide the same understanding as the object itself, or even a few pieces of the object; and whenever those have survived they ought to be saved.

The symposium opened with a showing of videotapes and films of information processing, followed by a discussion. The films were grouped into three kinds: (1) "Vintage films" (at least 15 years old) that have been found and considered to be worth saving; (2) Contemporary documentaries made with a historic purpose in mind, which include the commissioned videotapes of The Computer Museum and the video-history program at MIT under the direction of Ithiel de Sola Pool and his assistant, Richard Solomon; (3) Videotaped presentations of lectures and conferences devoted to historic topics.

"What would we give for a film of Babbage and Ada Lovelace just chatting, not even saying anything of historical interest?"

Video archives create separate archival issues. Videotapes are easy to make and getting less expensive every day, yet they are time consuming to edit, expensive to preserve, and require special equipment to watch.

Martin Campbell-Kelly, a collector of vintage films who uses films in his classes at the University of Warwick, led off the discussion. He suggested that all films and video should be rated. This set the group into discussion.

Jean Sammet: "Outside from the caveat of cost (and I realize that is a big one), I think everything created on film ought to be kept. I want to see expression on people's faces. I suspect that everyone has watched a rocket launch and gotten a thrill from it. It's only a piece of machinery going up in the air.

And so what? Fifty or a hundred years from now school children will watch them and think they are hysterical."

Helen Slotkin: "There were 1,024 rocket launches that were filmed. The national archivist has asked, do we have to keep all of them? There were 150 failures and everyone agrees to keep them."

Richard Solomon: "What would we give for a film of Babbage and Ada Lovelace just chatting, not even saying anything of historical interest?"

Gwen Bell: "We not only have to be concerned with what we save but also what we create."

Helen Slotkin: "An archivist is passive. Only gathers things. In creating records, you are saying there are holes and we will fill them. It is conscious and after-the-fact."

Gordon Bell: "Guidelines are needed for making films, because the Museum commissioned two films of decommissioning of machines; one is great and the other is awful."

Ithiel de Sola Pool: "The important thing is the groups of people and their relationships and how this comes across on videotape. Factual information can be better transferred in other ways."

Helen Slotkin: "Unless you know who the user will be, you can't make the decision about what to save. If you decide to film a conference, it could be used five different ways, and in each case it would be done differently."

Gordon Bell: "Let's only deal with the producer/storer problem, not the consumer problem. Nice to have the Los Alamos tapes and the Museum lecture tapes—in the first case the people were in a group and defending their turf and in the second they were on their own—the star. We need a set of rules of how to cut at the source."

Barbara Costello (Lawrence Livermore Laboratories): "Accuracy in videotapes is relatively difficult; not the same control as books; especially on the made tapes."

Gwen Bell: "At present, for the produced tapes, there is no reviewing system as there is for an article or book. They don't have the same kind of close scrutiny."

The Computer Museum's Video Archives:

Jean Sammet: "The script for the ENIAC tape could have been reviewed."

Ithiel de Sola Pool: "Yes, but my point is that Arthur Burks says that better on paper, and the interesting part is the film."

Gwen Bell: "But we commissioned the voice-over to help people understand the film."

Martin Campbell-Kelly: "I have the non-voice film and now I know that I want the voice-over version. Burks says exactly what people need to know. I bought the Fortran tape from the HOPL set because I thought it would be useful for teaching, but it was a disaster."

Jean Sammet: "What are you telling me? We shouldn't have made it? Shouldn't be selling it?"

Mike Williams (University of Calgary): "Looking at a cannibalized piece of the ENIAC, like the one at the Museum, doesn't do much for me. Why not just videotape everything and throw the junk out?"

Jean Sammet: "Wait a minute. There's a big difference between three dimensions and two. You want to see a picture of The Spirit of St. Louis and the airplane and get a feel for just what Lindberg had to contend with."

Martin Campbell-Kelly: "I travelled from England to see these pieces of junk and they do something for me. You'll eat those words when you see the Mark I at Harvard."

"A picture is worth a thousand words."

A gigantic computer flashes on the screen. The camera zooms in and we see a video display screen blinking "Hello, Mr. Murrow."

We're watching the Whirlwind starring on a 1952 segment of "See It Now." This film clip is not only worth a thousand words but 150,000 watts: the power necessary to turn on Whirlwind, which had less computing power than an Apple II. Old films can let visitors and scholars see historic machines in action—see what they were like and what it might have been like to program or work on one of them.

The video archives parallel the artifact collection—one often leads to the other. Usually the acquisition of a machine leads to finding film footage, but occasionally it happens in reverse.

The films and videotapes fall into three major categories: vintage films; historical documentaries; and lecture or conference videotapes.

Vintage Films

The Museum's Collection of vintage films, films made about contemporary computing to reach audiences of their time, is expanding slowly with the help of Museum members and other interested collectors. Through a lead from a Stanford Computer Science alumnus about a very good early film on timesharing, the Museum acquired *Ellis D. Kroptechev and ZEUS, his Marvelous Timesharing System*.

Two other films, *Machines That Think* (1922) and *Introduction to Punched Card Accounting* (1928) were added to the film and video archives on the suggestion of Martin Campbell-Kelly, an avid film collector and Professor of Computer Science, University of Warwick.

To date, the collection has only contemporary documentaries. The Museum would like to branch out and start a collection of vintage entertainment films featuring the computer as a central character. *2001*, *Deskset*, and *Metropolis* are some examples. We would like to know your favorites as we start to build this collection.

Historical Documentaries

Historical documentaries are films made to preserve history. When one-of-a-kind machines are being retired, the Museum urges that a film be made of the installation. A 15-minute documentary was made by Brigham

Young University of the last Stretch (IBM 7030) in operation, at our request. Stretch, in its later years, was not the same as Stretch in the early sixties when it was the centerpiece of Los Alamos. The film, although important, doesn't have the snap of a film made for a contemporary purpose. Yet historical documentaries are essential to make when nothing else exists.

The Museum has also shot over two hours of raw footage of Harold Cohen making his art, and made one documentary that explains the 1981 version of his program. We will supplement that with the footage showing the more recent evolution of his computer art.

Lecture and Conference Videotapes

The Museum's lecture videotapes and assorted History of Computing Conference videotapes represent over two-thirds of the Museum's film and video collection. These videotapes of significant contributors to the development of information processing technology serve as a primary data source for scholars and students. The Museum receives requests from across the country for copies of specific lecture tapes. Included are first-hand opinions from Konrad Zuse, who believed that with the development of the stored program "the devil entered the machine," and vivid reminiscences of Grace Hopper, who described the pressures of working during WWII on the Mark I. These tapes provide direct accounts of crucial developments in computing technology and indirectly convey the environment and atmosphere of the projects. Each lecture at the Museum is videotaped for the archives. The History of Programming Languages, 1978 (HOPL), and International Research Center, 1976 (IRC) Conference tapes were gifts from private donors.

Film and Video Archives

Once received by the Museum staff, the film or videotape is carefully indexed and then sent to a professional lab to be copied onto videotape. The masters of the films and videotapes are then stored in a climate controlled room monitored by a professional staff. Videotapes are run once a year to maintain their quality.

The copies of the original films and videotapes are held in the film and video archives for viewing by staff and Museum members.

Vintage Films

Apollo Guidance Computer. (silent film) Apollo Instrumentation Laboratory at TI, circa 1968, 20 minutes. Gift of Charles Stark Draper Laboratory.

EDSAC. Cambridge University Mathematics Laboratory, 1951, 10 minutes. Gift of Maurice Wilkes.

ENIAC: Newsreel footage with narration by Professor Arthur Burks, The Moore School and The Computer Museum, 1946, 30 minutes. Gift of Arthur Burks.

In Your Defense: SAGE. Western Electric and the U.S. Air Force, 1961, 25 minutes. Gift of MITRE Corporation.

Introduction to Punched Card Accounting. circa 1928.

LINC With Tomorrow. National Public Television, circa 1965. Gift of Digital Equipment Corporation.

Machines That Think. Stoll Theatres, 1922.

Making Electrons Count. MIT and the Office of Naval Research, 1953, 25 minutes. Gift of MIT.

MANIAC. Los Alamos Scientific Laboratory, circa 1961, 20 minutes. Gift of Los Alamos Scientific Laboratory.

MIT Lincoln Laboratory TX-0. MIT, 1959, 10 minutes. Gift of MIT.

See It Now: The WHIRLWIND. CBS TV, 1952, 6 minutes.

Sketchpad: MIT Lincoln Laboratory TX-2. MIT, 1960, 12 minutes. Gift of MIT.

The Powers-Samas Film. (silent) British Geological Records Center, circa 1960, 10 minutes.

Tomorrow: The Thinking Machine. CBS TV, 1961, 60 minutes. Gift of MIT.

Ellis D. Kropotchev and Zeus, his Marvelous Time Sharing System. Stanford University, circa 1965, 15 minutes. Gift of Stanford University Computer Science Department.

Historical Documentaries

A CAM (Computer-Aided-Manufacturing) Update. Automatix, 1980, 40 minutes. Gift of Automatix.

Art by Computer: Museum Murals by Harold Cohen. The Computer Museum, 1980, 8 minutes.

Adaptive Control Devices. Case Western Reserve University. Instructional Television Network, 1978, 14 minutes. Gift of Jim Rogers.

History of Computing in Business. GTE's Communication and Training Center, 11 minutes. Gift of IDG.

Invention of the First Electrical Digital Computer. Bell Labs, 15 minutes. Gift of Bell Labs.

Powers of Ten. Pyramid, 10 minutes, 1978.

STRETCH: The Technological Link between Yesterday and Tomorrow. Brigham Young University and The Computer Museum, 1981, 15 minutes.

Museum Lectures

Amdahl, Gene, **From WISC to TRILOGY.** 1983.

Atanasoff, John Vincent, **The Forces That Led to the Design of the Atanasoff-Berry Computer.** 1980.

Brainerd, John, **ENIAC.** 1981.

Burks, Arthur, **The Origin of the Stored Program.** 1982.

Wes Clark, **LINC.** 1981.

Cohen, Harold, **How I Produce Computer Generated Art.** 1980.

Edwards, Dai, **Early Manchester Computers.** 1981.

Flowers, Tom H., **Design and Use of Colossus: WWII Code-Breaking Machine.** 1981.

Forrester, Jay, **Whirlwind.** 1980.

Grosch, Herbert, **The Watson Scientific Laboratory, 1945-1950.** 1982.

Hopper, Grace, **Howard Aiken and the Harvard Mark I.** 1983.

Huskey, Harry, **From Pilot ACE to the G-15.** 1982.

Lehmer, D.H., **History of the Sieve Machines.** 1982.

Hogan, Les, **The Origin, Evolution and Future of the Semiconductor Industry.** 1983.

Stibitz, George, **Design of the Bell Labs Relay Computers.** 1980.

Wilkes, Maurice, **EDSAC.** 1979.

Wilkinson, James, **The Pilot ACE.** 1981.

Zuse, Konrad, **Z1, Z2 and Z3, 1936-1947.** 1981.

History of Programming Languages (HOPL) Conference. Los Angeles, California, June 10, 1978. 23 videotapes. Gift of Association for Computing Machinery.

International Research Conference (IRC) on the History of Computing in the Twentieth Century. Los Alamos, New Mexico, June 10-15, 1976. 33 videotapes. Gift of Bill Luebbert.



The last segment of Tomorrow: The Thinking Machine, a 1961 TV program produced by CBS for MIT's one hundredth birthday, features a computer-written Western. Harrison (Dit) Morse wrote the program on the TX-0 (with its 32K bits of core memory). Doug Ross (upper right) explains the logical choices the machine could make about the placement of the robber and the sheriff, the gun, the table, the window, the door, the whiskey bottle, etc. Actor Jack Gilford plays the role of the robber, cleaning his gun while the sheriff looks on. Three versions are produced on the film, including one in which the computer program got stuck in a loop.

A question to the readers: Does this program and film qualify as the first artificial intelligence program written to produce a play?



The Origin of Spacewar

J. M. Graetz

1. BEFORE SPACEWAR!

The Lensman, The Skylark, and the Hingham Institute

It's Kimball Kinnison's fault. And Dick Seaton's. Without the *Gray Lensman* and the *Skylark of Space* there would be nothing to write about. So most of the blame falls on E. E. Smith, but the Toho Film Studios and the American Research and Development Corp. have something to answer for as well. If Doc Smith had been content designing doughnuts, if American-International Pictures had stuck to beach blanket flicks, if (most of all) General Doriot hadn't waved money in front of Ken Olsen in 1957, the world might yet be free of *Spacewar!*

It all came together in 1961 at the Hingham Institute, a barely habitable tenement on Hingham Street in Cambridge, MA. Three Institute Fellows were involved: Wayne Wiitanen, mathematician, early music buff, and mountain climber; J. Martin Graetz (which is me), man of no fixed talent who tended to act superior because he was already a Published Author; and Stephen R. (Slug) Russell, specialist in steam trains, trivia, and artificial intelligence. We were all about 25 (the more or less to be the same).

At the time, we were crashing and banging our way through the "Skylark" and "Lensman" novels of Edward E. Smith, PhD, a cereal chemist who wrote with the grace and refinement of a pneumatic drill.

In a pinch, which is where they usually were, our heroes could be counted on to come up with a complete scientific theory, invent the technology to implement it, build the tools to implement the technology, and produce the (usually) weapons to blow away the baddies, all while being chased in their spaceship hither and thither throughout the trackless wastes of the galaxy (he wrote like that) by assorted Fenachrone, Boskonians, and the World Steel Corporation.

In breaks between books, we would be off to one of Boston's seedier cinemas to view the latest trash from Hollywood. These movies depended for their effects on high quality modelwork, oceans of rays, beams, explosions and general brouhaha, and the determined avoidance of plot, character, or

significance. They were the movie equivalent of *The Skylark of Space*.

If that's the case, we asked ourselves, why doesn't anyone make *Skylark* movies? Hearing no reply (our innocence of current film technology, economics, and copyright laws was enormous), we often passed the time in the Hingham Street common room in deep wishful thought, inventing special effects and sequences for a grand series of space epics that would never see a sound stage. Nonetheless, these books, movies, and bull-sessions established the mind-set that eventually led to *Spacewar!*

When Computers Were Gods

In early 1961 Wayne, Slug, and I, by no coincidence, were all working at Harvard University's Littauer Statistical Laboratory. A large part of our jobs was to run statistics computations on an IBM 704.

To a generation whose concept of a computer is founded on the Z80 chip, it may be hard to visualize a 704 or to comprehend the place it held in the public imagination. It was a collection of mysterious hulking gray cabinets approachable only through the intercession of The Operator.

Everything about the 704, from the inscrutable main frame to the glowing tubes in the glass-walled core memory case, proclaimed that this was a Very Complicated System operated only by Specially Trained Personnel, among whom programmers and other ordinary mortals were not numbered. In short, a computer was something that you simply did not sit down and fool around with.

A Stone's Throw From Olympus

In the summer of 1961 I went to work for Professor Jack B. Dennis, who was then the proprietor of the TX-O, a machine that to me was only slightly less legendary than its ancestor, Whirlwind. The TX-O was transistorized, and while solid-state computers were beginning to appear on the market, the "Tixo" was the original. Even in 1961 it was acknowledged to be a historically important research facility; many of the programs developed on the TX-O, such as Jack Dennis's MACRO Assembler and Thomas Stockham's FLIT debugging program, were the first of their kind. So the chance to work on this computer was in many ways a rite of passage; it meant

that I had joined the ranks of the Real Programmers.

While hardly your average populist Apple, the TX-O was definitely a step away from the Computer-As-Apollo. Instead of being sealed into its own special chapel, it sat at one end of a typical large, messy MIT research space: With its racks of exposed circuitry, power supplies and meters, and its long, low L-shaped console, the TX-O looked for all the world like the control room of a suburban pumping station. And the thing of it was, you were expected to **run it yourself**.

The TX-O's input and output medium was a Flexowriter: an all-in-one keyboard, printer, paper-tape reader and punch, that worked like a mule and had a personality to match. There was also a "high-speed" paper tape reader, a Grand Prix whiz that could read programs into memory almost as fast as the cassette-tape reader on a TRS-80.

And the TX-O had a scope. Console-mounted, programmable CRTs were not unheard of at that time but they were generally slow, inflexible, and awkward to program. The TX-O scope, on the other hand, was easy to use; you could generate a useful display with fewer than a dozen instructions. And if that weren't enough, there was a magic wand: the light pen.

That was the TX-O: the world's first on-line computer, and the training ground for the designers and programmers of later generations of hands-on machines. The first computer bums—hackers—were the products of this training; without it, and them, there would have been no *Spacewar!*

Tixo's People

The users of the TX-O were a melange of students, staff researchers and professors with not much in common other than their need for large amounts of largely unstructured computer time. The feel of the place, however, was established by the hackers—mostly students, but including a professor or two—whose lives seemed to be organized in 18-bit strings.

Out of this cloud of computer bums emerged the group that brought *Spacewar!* to the silver (well, light gray) screen: Dan Edwards (AI Group), LISP specialist; Alan Kotok (TX-O staff), who wrote the MIDAS Debugger; Robert A. Saunders (TX-O staff), who wrote

MIDAS, the successor to MACRO; Peter Samson (AI Group), who made the Tixo and PDP-1 play Bach, and Steve Russell and I.

"You Mean That's All It Does?"

When computers were still marvels, people would flock to watch them at work whenever the opportunity arose. They were usually disappointed. Whirring tapes and clattering card readers can hold one's interest only so long. They just did the same dull thing over and over.

On the other hand, something is always happening on a TV screen, which is why people stare at them for hours. On MIT's annual Open House day, for example, people came to stare for hours at Whirlwind's CRT screen. What did they stare at? Bouncing Ball.

Bouncing Ball may be the very first computer-CRT demonstration program. It didn't do much: a dot appeared at the top of the screen, fell to the bottom and bounced (with a "thok" from the console speaker). It bounced off the sides and floor of the displayed box, gradually losing momentum until it hit the floor and rolled off the screen through a hole in the bottom line. And that's all. Pong was not even an idea in 1960. (Note: Well, maybe not Pong, but something very much like it. Watch these pages. —DHA)

The TX-O's counterpart to Bouncing Ball was the Mouse in the Maze, written by Douglas T. Ross and John E. Ward. Essentially, it was a short cartoon; a stylized mouse searched through a rectangular maze until it found a piece of cheese which it then ate, leaving a few crumbs. You constructed the maze and placed the cheese (or cheeses—you could have more than one) with the light pen. A variation replaced the cheese with a martini; after drinking the first one the mouse would stagger to the next.

Besides the Mouse, the TX-O also had HAX, which displayed changing patterns according to the settings of two console switch registers. Well-chosen settings could produce interesting shapes or arrangements of dots, sometimes accompanied by amusing sounds from the console speaker. The console speaker is a phenomenon whose day seems to have passed. (More than just a plaything, for the experienced operator the speaker was a valuable guide to the condition of a running program.)

Finally, there was the inevitable Tic-Tac-Toe, with the user playing the computer. The TX-O version used the Flexowriter rather than the scope. (The game is so simple to analyze that there

was even a version for the off-line Flexo.)

These four programs pointed the way. Bouncing Ball was a pure demonstration: you pushed the button, and it did all the rest. The mouse was more fun, because you could make it different every time. HAX was a real toy; you could play with it while it was running and make it change on the fly. And Tic-Tac-Toe was an actual game, however simpleminded. The ingredients were there; we just needed an idea.

The World's First Toy Computer

For all its homeliness, the TX-O was still very much a god. It took up lots of space, it had to be carefully tended, it took special procedures to start it up and shut it down, and it cost a lot of money to build.

All this changed in the fall of 1961, when the first production-model PDP-1 was installed in the "Kluge Room" next door to the TX-O. It had been anticipated for months; an early brochure announcing the machine (as well as a couple of noshows called the PDP-2 and PDP-3, in case you were wondering about that) had been circulating in the area for a while. It was clear that the PDP-1 had TX-O genes; the hackers would be right at home.

The -1 would be faster than the Tixo, more compact and available. It was the first computer that did not require one to have an E.E. degree and the patience of Buddha to start it up in the morning; you could turn it on anytime by flipping one switch, and when you were finished, you could turn it off. We had never seen anything like that before.

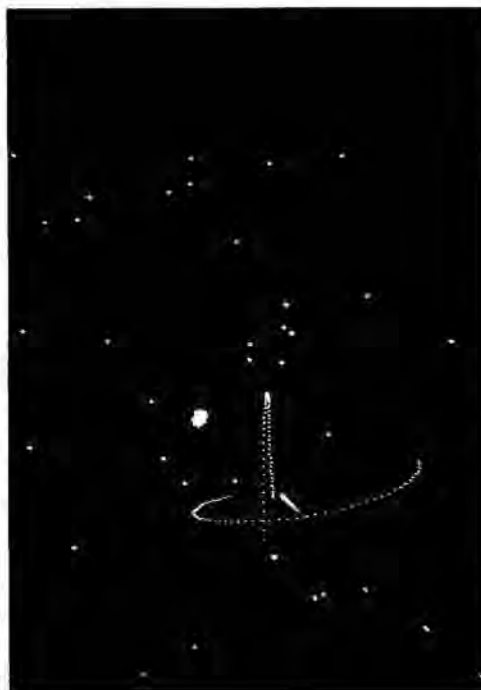

II. SPACEWAR! BEGUN

The Hingham Institute Study Group On Space Warfare

Long before the PDP-1 was up and running, Wayne, Slug and I had formed an ad-hoc committee on what to do with the Type 30 Precision CRT Display which was scheduled to be installed a couple of months after the computer itself. It was clear from the start that while the Ball and Mouse and HAX were clever and amusing, they really weren't very good as demonstration programs. Zooming across the galaxy with our Bergenholm Intertialless Drive, the Hingham Institute Study Group on Space Warfare devised its Theory of Computer Toys. A good demonstration program ought to satisfy three criteria:

- 1) It should demonstrate, that is, it should show off as many of the computer's resources as possible, and tax those resources to the limit.
- 2) Within a consistent framework, it should be interesting, which means that every run should be different.
- 3) It should involve the onlooker in a pleasurable and active way—in short, it should be a game.

With the Fenachrone hot on our ion track, Wayne said, "Look, you need some kind of sk action and you need some kind of sk level. It should be a game where you have to control things moving around on the scope, like, oh, spaceships. Something like an explorer game, or a race or contest . . . a flight, maybe?"

"SPACEWAR!" shouted Slug and I, as the last force screen flared into the violet and went down.

The basic rules developed quickly. There would be at least two spaceships, each controlled by a set of console switches ("Gee, it would be neat to have a joystick or something like that . . ."). The ships would have a supply of rocket fuel and some sort of weapon; a ray or a beam, possibly a missile. For really hopeless situations, a panic button would be nice . . . hmmm . . . aha! Hyperspace! (What else, after all, is there?) And that, pretty much, was that.

The Hackers Meet SPACEWAR!

By the end of summer, 1961, Steve Russell had returned to the Artificial Intelligence Group (he'd worked there before Littauer); consequently, whatever ideas the Study Group came up with were soon circulating among the hackers. Spacewar! was an appealing, simple concept, and the hackers



Gleefully playing Spacewar! at a spring Bits and Bites talk are (left to right) Alan Kotok, Steve Russell and Shag Graetz. Spacewar!, the first video game and one of the Museum's software artifacts, was designed for a PDP-1 by Graetz, Russell and Wayne Wittenan in 1961.

were the appealingly simple people to bring it to life. First, however, there was the small matter of software.

The PDP-1 was a no-frills machine at the beginning; except for a few diagnostic and utility routines, there was no program library. In a way this suited the hackers just fine; here was a chance both to improve on TX-O software and to write new stuff that couldn't have been done before. First, and fairly quickly, MACRO and FLIT were translated from TXish to PDPese, FLIT becoming the first in a continuing line of DDT on-line debugging programs. Steve Piner PDP-1 wrote a text display and editing program called Expensive Typewriter.

With the software taken care of we could write real programs, which is to say toys. Bouncing Ball was successfully converted to PDP-1 use, but HAX for some reason, was not. But no one really missed it, because we had a brand-new toy invented by Professor Marvin Minsky. The program displayed three dots which proceeded to "interact," weaving various patterns on the scope face. As with HAX, the initializing constants were set in the console switches. Among the patterns were geometric displays, Lissajous-like figures, and "fireworks." Minsky's program title was something like "Tri-Pos: Three-Position Display" but from the beginning we never called it anything but The Minskytron. ("tron" was the In suffix of the early 1960s.)

at Steps

By the end of 1961, all the elements were in place, a brand new, available computer, a cloud of hackers, tolerant when not actively implicated employ-

ers, and an exciting idea. Slug Russell was getting the heat from everyone to "do something" about Spacewar! (I was in a different department at MIT by this time and Wayne, alas, was one of those unlucky Army Reservists called to active duty during the Berlin Wall panic in October. He never got to participate in developing his own idea.)

Russell, never one to "do something" when there was an alternative, begged off for one reason or another. One of the excuses for not doing it, Slug remembers, was "Oh, we don't know how to write a sine-cosine routine . . ." Then Alan Kotok came back from a trip all the way to Maynard (DEC headquarters) with paper tapes saying "All right, Russell, here's a sine-cosine routine; now what's your excuse?" "Well," says Slug, "I looked around and I didn't find an excuse, so I had to settle down and do some figuring."

With the heavy mathematics in hand, Slug produced the first object-in-motion program in January 1962. This was nothing more than a dot which could accelerate and change direction under switch control. Even without a hardware multiply-divide capability (on the early PDP-1s, anything stiffer than integer addition and subtraction had to be done by sub-routine) the computer was clearly not being pushed.

From dot to rocket ship was a surprisingly easy step. "I realized" Slug says, "that I didn't have to worry about the speed of the sine-cosine routine, because there were only two angles involved in each frame—one for each ship. Then the idea of rotating the grid

came out." The ship outlines were represented as a series of direction codes starting from the nose of the ship; when the ship was vertical and tail-down, each code digit pointed to one of the five possible adjacent dots that could be displayed next. To display the ship at an angle, Russell calculated the appropriate sine and cosine and added them to the original direction code constants, in effect rotating the entire grid. With this method, the ship's angle had to be calculated only once in each display frame. The outline codes were kept in a table so that different shapes could be tried out at will, but this meant that the table had to be searched every frame to generate the outline. As the game developed, this arrangement proved to be a sticking point which, as we shall see, was neatly solved by Dan Edwards.

By February, the first game was operating. It was a barebones model; just the two ships, a supply of fuel, and a store of "torpedoes"—points of light fired from the nose of the ship. Once launched, a torpedo was a ballistic missile, zooming along until it either hit something (more precisely, until it got within a minimum distance of a ship or another torpedo) or its "time fuse" caused it to self-destruct.

The classic needle and wedge ship outlines and the opposite-quadrant starting positions were established at this stage, as shown in Figure 1. Acceleration was realistic; it took time to get off the mark, and to slow down you had to reverse the ship and blast in the other direction; the rocket exhaust was a flickering "fiery tail."

Rotation, on the other hand, was

by something we called "gyros"—a sort of flywheel effect invented to avoid consideration of messy things like moments of inertia. I guess they were really rotational Bergenholms.

It was apparent almost immediately that the featureless background was a liability. It was hard to gauge relative motion; you couldn't tell if the ships were drifting apart or together when they were moving slowly. What we needed, obviously, were some stars. Russell wrote in a random display of dots and the quality of play improved. The only thing left, we thought, was hyperspace, and that was on the way. In fact, we'd just begun.



III. SPACEWAR! COMPLETE

Please keep in mind that what follows did not happen in a neat first-one-thing-and-then-the-next progression, but rather all at once in a period of about six weeks. When hackers are aroused, anything that can happen will.

The Control Boxes

Spacewar! worked perfectly well from the test word switches on the console, except that the CRT was off to one side, so one player had a visual advantage. More to the point, with two excitable space warriors, jammed into a space meant for one reasonably calm operator, damage to the equipment was a constant threat. At the very least, a jittery player could miss the torpedo switch and hit the start lever, obliterating the universe in one big anti-bang. A

separate control device was obviously necessary, but joysticks (our original idea) were not readily available in 1962. So Alan Kotok and Robert A. Saunders, who just happened to be members of the Tech Model Railroad Club, trundled off to the TMRC room, scabbled around the layout for a while to find odd bits of wood, wire, bakelite, and switchboard hardware, and when the hammering and sawing and soldering had ceased, there on the CRT table were the first Spacewar! control boxes (Figure 2. These boxes have long since disappeared, but the sketch is a reasonably accurate reconstruction).

The box is wood with a Bakelite top. The two switches are double-throw; the button is a silent momentary switch. Their functions are as follows:

- a. Rotation control. It is pushed to the left to rotate the ship counter-clockwise, to the right to rotate clockwise.
- b. A two-function control. Pulled back, it is the rocket accelerator; the rocket continues to blast as long as the switch is thrown. Pushed forward, the switch is the hyperspace control, as described below.
- c. The torpedo button. It had to be silent so that your opponent could not tell when you were trying to fire. (There was a fixed delay between shots "to allow the torp tubes to cool" and fire was not automatic; you had to keep pushing the button to get off a missile.)

With the control boxes players could sit comfortably apart, each with a clear view of the screen. That, plus the carefully designed layout of the controls, improved one's playing skills considerably, making the game even more fun.

The Stars of the Heavens

One of the forces driving the dedicated hacker is the quest for elegance. It is not sufficient to write programs that work. They must also be "elegant," either in code or in function—both, if possible. An elegant program does its job as fast as possible, or is as compact as possible, or is as clever as possible in taking advantage of the particular features of the machine in which it runs, and (finally) produces its results in an esthetically pleasing form without compromising either the results or operation of the other programs associated with it. "Peter Samson," recalls Russell, "was offended by my random stars." In other words, while a background of miscellaneous points of light might be all very well

for some run-down jerkwater space fleet, it just wouldn't do for the Galactic Patrol. So Peter Samson sat down and wrote "Expensive Planetarium."

Using data from *The American Ephemeris and Nautical Almanac*, Samson encoded the entire night sky (down to just above fifth magnitude between 22½ degrees N and 22½ degrees S, thus including most of the familiar constellations). The display can remain fixed or move gradually from right to left, ultimately displaying the entire cylinder of stars. The elegance does not stop there. By firing each displayed point the appropriate number of times, Samson was able to produce a display that showed the stars at something close to their actual relative brightness. An attractive demonstration program in its own right, E.P. was "duly admired and inhaled into Spacewar!"

The Heavy Star

Up to this point, Spacewar! was heavily biased towards motor skills and fast reflexes, with strategy counting for very little. Games tended to become nothing more than wild shoot-outs, which was exciting but ultimately unrewarding. Some sort of equalizer was called for.

Russell: "Dan Edwards was offended by the plain spaceships, and felt that gravity should be introduced" pleaded innocence of numerical analysis and other things—in other words, here's the whitewash brush and there's a section of fence—"so Dan put in the gravity calculations."

The star blazed forth from the center of the screen, its flashing rays a clear warning that it was not to be trifled with. Its gravity well encompassed all space; no matter where you were, if you did not move you would be drawn into the sun and destroyed. (As a gesture of good will towards less skillful or beginning players, a switch option turned annihilation into a sort of hyperspatial translation to the "anti-point," i.e., the four corners of the screen.)

The star did two things. It introduced a player-independent element that the game needed; when speeds were high and space was filled with missiles, it was often sheer luck that kept one from crashing into the star. It also brought the other elements of the game into focus by demanding strategy. In the presence of gravity both ships were affected by something beyond their control, but which a skillful player could use to advantage.

The first result of this new attention to strategy was the opening move

in Figure 3, which was quickly dubbed the "CBS opening" because of its eye-like shape. It took a while to learn this maneuver but it soon became the standard opening among experienced players, as it generally produced the most exciting games.

The addition of gravity pushed *Spacewar!* over the edge of flicker-free display. To get back under the limit, Dan Edwards devised an elegant fiddle to speed up the outline display routine.

In Russell's original program, the outline tables were examined and interpreted in every display frame, an essentially redundant operation. Edwards replaced this procedure with an outline "compiler," which examined the tables at the start of a game and compiled a short program to generate the outline for each ship. This dramatically reduced calculation time, restoring the steady display and making room for the last of the original bells and whistles.

Hyperspace

While all this was going on, I was in my secret hideaway (then known as the Electronic Systems Lab) working on the ultimate panic button: hyperspace. The idea was that when everything else failed you could jump into the fourth dimension and disappear. This would introduce an element of something very like magic into an otherwise rational universe, the use of hyperspace had to be hedged in some way. Our ultimate goal was a feature that, while useful, was not entirely reliable. The machinery, we said, would be "the Mark One Hyperfield Generators . . . hadn't done a thorough job of testing . . . rushed them to the fleet" and so on. They'd be good for one or two shots, but would deteriorate rapidly after that. They might not work at all ("It's not my fault, Chewiel!") or if they did, your chances of coming back out intact were rather less than even. Slug: "It was something you could use, but not something you wanted to use."

The original hyperspace was not that elegant. "MKI unreliability" boiled down to this: you had exactly three jumps. In each jump your ship's co-ordinates were scrambled so that you never knew where you would reappear—it could be in the middle of the sun. You were gone for a discernible period of time, which gave your opponent a bit of a breather, but you came back with your original velocity and

direction intact. To jump, you pushed the blast lever forward.

Hyperspace had one cute feature (well, I thought it was cute). Do you remember the Minskytron? One of its displays looked very much like a classical Bohr atom, which in those days was an overworked metaphor for anything to do with space and science-fiction. Reasoning that a ship entering hyperspace would cause a local distortion of space-time resulting in a warp-induced photonic stress emission (see how easy this is?), I made the disappearing ship leave behind a short Minskytron signature (Figure 4).

Crocks and Loose Ends

In retrospect, it is remarkable that the original *Spacewar!* managed to include so many features, given the limitations of our PDP-1: 4K words (about 9K bytes) of memory, an instruction cycle time of five microseconds, and a subroutine multiply-divide. It's hardly surprising, then, that we had to let a few unsatisfactory (all right, inelegant) bits go by.

The most irritating of these (and the first to be improved in later versions) was the appropriately-named Crock Explosion. Something dramatic obviously had to happen when a ship was destroyed, but we were dealing with a plain dot-matrix screen. The original control program produced a random-dot burst confined within a small square whose outlines were all too discernible (Figure 5).

This explosion was intended merely as a place-holder until something more plausible could be worked out, but after all the other features had been "inhaled," there wasn't room or time for a fancier calculation.

Similarly, the torpedoes were not quite consistent with the *Spacewar!* universe after the heavy star was in place. The gravity calculations for two ships was as much as the program could handle; there was no time to include half a dozen missiles as well. So the torpedoes were unaffected by the star, with the odd result that you could shoot right through it and hit something on the other side (If you weren't careful getting round the Star, it could be you.). We made the usual excuses . . . mumble mumble photon bombs mumble mumble . . . but no one really cared.

The heavy star itself was not entirely Newtonian. The common tactic of plunging down the gravity well to gain momentum by whipping around the sun (Figure 6) gave you somewhat more energy than you were really entitled to. As this just made the game

more interesting, nothing was immediately done to correct it.



IV. AFTER SPACEWAR

The game was essentially complete by the end of April, 1962. The only further immediate work was to make *Spacewar!* presentable for MIT's annual Science Open House in May. A scoring facility was added so that finite matches could be played, making it easier to limit the time any one person spent at the controls. To provide for the crowds that we (accurately) anticipated, a large screen laboratory CRT was attached to the computer to function as a slave display. Perched on top of a high cabinet, it allowed a roomful of people to watch in relative comfort. Also in May, the first meeting of DECUS (Digital Equipment Computer Users' Society) was held in Bedford, MA. At that meeting I delivered the first paper on the subject, pretentiously titled "Spacewar! Real-Time Capability of the PDP-1."

Over the summer of 1962, the original *Spacewar!* hackers began to drift away. Alan Kotok and I went to work for Digital. Steve Russell followed John McCarthy to Stanford University. Peter Samson and Bob Saunders stayed in Cambridge for a while, but eventually they, too, went west. Dan Edwards remained with the AI group for a few years, then moved to Project MAC, Jack Dennis and the PDP-1 also wound up at Project MAC, which evolved into MIT's Laboratory for Computer Science. Others took up the maintenance and development of *Spacewar!* Program tapes were already showing up

* Quoted in *Two Cybernetic Frontiers* by Stewart Brand (Random House, 1974)

all over the country, not only on PDP-1s but on just about any research computer that had a programmable CRT.

A Mystery, Just For Good Measure

Slug tells me that there is a Lost Version of *Spacewar!* There would be, of course. He says the game is pretty much like the original, but the scoring is much more impressive. After each game of a match, cumulative scores are displayed as rows of ships, like a World War II fighter pilot's tally. Slug says he saw this version for a short time on the PDP-1, but never found out who produced it or what became of it.

Twenty Years Later

The original *Spacewar!* PDP-1 was retired in 1975 and put in storage at DEC's Northboro warehouse, where it serves as a parts source for the similar machine now on working display at Digital's Computer Museum in Marlboro, MA. At this writing, DEC engineer Stan Schultz and I are trying to put the original *Spacewar!* back into operating condition. So far, all attempts at finding the original control boxes have been futile; we will probably build replicas (the plastic Atari joysticks we have now got no class).

Dan Edwards still works for the U.S. Government, developing computer security systems. Alan Kotok is still a consulting engineer with DEC. Peter Samson is now director of marketing for Systems Concepts, Inc., in San Francisco. Bob Saunders had gone to Silicon Valley, where he is an engineer-programmer for Hewlett-Packard.

Jack Dennis is a Professor of Computer Science at MIT, in the Laboratory thereof.

Marvin Minsky is Donner Professor of Science in the Electrical Engineering Department at MIT.

John McKenzie, the chief engineer, is retired, but over the past year or so has been helping to restore the TX-O and PDP-1 to life at the Computer Museum.

And what of the Hingham Institute? Wayne Wiitanen has recently become a Senior Research Scientist at the General Motors Research Laboratory, where he is happily designing eyes for robots. Slug, after various adventures, is now a programmer-analyst for Interactive Data Corporation in Waltham, MA. I am reduced to writing for a living, but tend to act somewhat less superior therefor.

Spacewar! itself has bred a race of noisy, garishly-colored monsters that lurk in dark caverns and infest pizza parlors, eating quarters and offering degenerate pleasures. I think I know a few former hackers who aren't the slightest bit surprised.

Acknowledgements

I was able to reach all of the original *Spacewar!* perpetrators, hackers and Hingham Institute Fellows alike. Not to mention Professors Dennis and Minsky, and John McKenzie. In addition, I am grateful to Marcia Baker, Professor F.J. Corbato, and Professor R.M. Fano, all of MIT, for help with dates and places, and other facts. The help was theirs; any mistakes are mine.

Reprinted with permission from Creative Computing, 39 E. Hanover Avenue, Morris Plains, NJ 07950

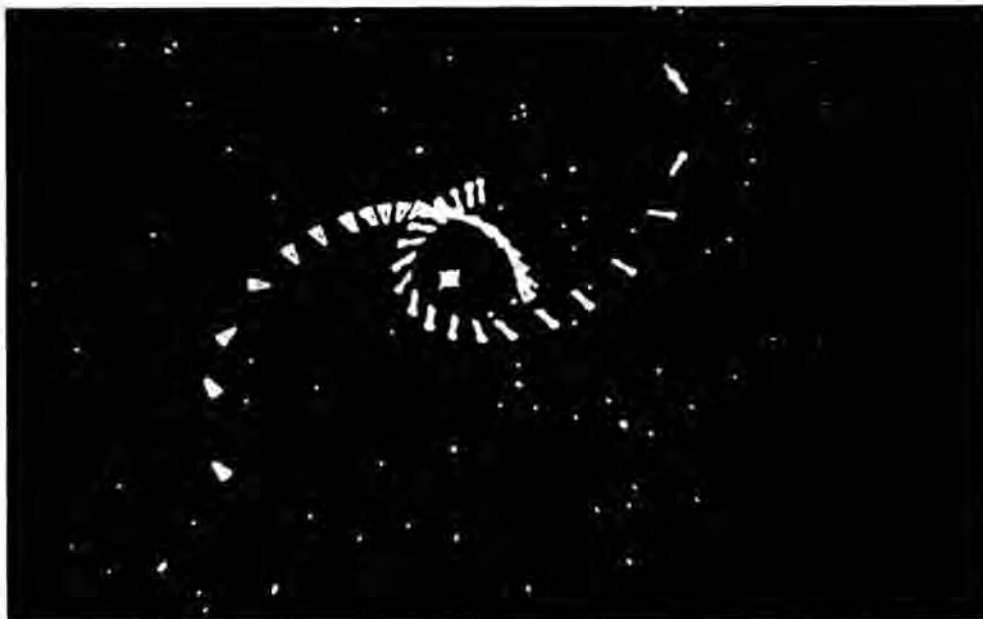

Developing Univac's Plated Thin Film Metal Recording Tape

Ted Bonn, April 17, 1983

While I was at the Moore School of Engineering at The University of Pennsylvania, I took a course with John Mauchly. Then, after I received my Masters degree, Eckert made me an offer. In early September 1947, I climbed to the second floor over a haberdashery in downtown Philadelphia and started to work in the offices and labs of the Eckert-Mauchly Computer Corporation.

Since available acetate base tape materials and magnetic laquer coatings were not good enough, I was assigned to develop plated thin film metal magnetic recording tape for the Universo I. We chose 1/2" wide phosphor bronze tape as the substrate. I knew nothing about plating or magnetic alloys. My starting point was the fact that someone in the Brush Development Company had learned how to electroplate nickel iron permalloy and someone at the Bureau of Standards had learned how to deposit permalloy chemically without current. Since plating was a chemical process I obviously needed a lab with a fume hood, water drains and so forth. One powder room became my lab and the other was left for its intended purpose. The window would be opened to clear out fumes. I would get water out of the sink and the toilet was an ideal drain. Of course, I had to be sure to flush a couple of times when I dumped in acids so that they would not eat the pipes. Being an electrical engineer I would frequently miscalculate the amount of ammonium salts needed and the room would fill with fumes. Then I would throw up the window and stick my head out. But occasionally the door would be opened and the wind would be blowing in the wrong direction, then all Eckert-Mauchly would fill with ammonia fumes.

The chemistry went faster than the electronics. We could deposit a film before we could measure its magnetic properties. We made a piece about three feet long, soldered the ends together to make a loop and mounted it on a loop tester. We tried to record on it. John Mauchly was excited and right at my shoulder. No output. I checked the electronics, and the head, and the write current. Still nothing. Then John remarked that there appeared to be a signal at the joint where the two ends of the tape were soldered. I had seen it



too, but it didn't look like a recording signal and I ignored it. John correctly interpreted it as a signal caused by improved magnetic properties due to the heat of soldering. His astute observations started me on a series of experiments on heat treating tape. It was not the final answer, but it was a key answer along the way.

I built a pilot production line and Reed Stovall built and debugged the actual production equipment. The same thin electroplated magnetic film was used by Univac on the LARC drum and on the Fastrand, and many other recording drums and discs throughout the industry. Plated tape was used exclusively with the Univac systems until about 1956 or 1957 when mylar base and epoxy resins became available.

You could see the holes in cards, but we had difficulty convincing some people that there was actually information recorded on the tape, since there is no visible difference between recorded and unrecorded tape. So we made the recording visible. Fine magnetic particles were suspended in a solvent and applied to the tape. The particles were attracted to the magnetic poles and when the solvent evaporated you could clearly see the recorded information. The tracks and the interblock gap stood out. You could pick the pattern up with scotch tape and apply the tape to paper and carry it around to demonstrate.

The design of the tape handler, called "Universo," set the standard for the industry. It featured 100 inch per second tape speed; 120 bits per inch recording density; eight tracks on half-inch wide tape for a data rate of 12,000 characters per second; a start/stop time of 10 milliseconds, this meant the 720 digit block could be recorded in 5.6 inches and the interblock gap was only 2.4 inches long. Thus the Eckert-Mauchly team established magnetic tape as the high speed input/output medium for computers and designed and successfully produced a complete line of magnetic tape based peripherals.

This narrative explanation given by Ted Bonn at a Sunday Bits and Bites talk corrects misinformation printed in the Summer Report (Page 16) describing the UNIVAC tape.

Captain Grace Hopper on the Harvard Mark I



April 14th, Captain Grace Hopper spoke on her experiences with Commander Howard Aiken and the Harvard Mark I. The text of this lecture will be incorporated into her contribution to a book on the same subject that is being edited by Professor I. Bernard Cohen.

Speaking to a rapt audience of more than 500 people, Captain Hopper told of her introduction to the machine: "Aiken waved his hand at Mark I, all 51 feet of her, and he said, 'That's a computing engine.' Not a computer. Not a calculator. And there's a difference in the concept that was in his mind as well. Computers are what we have nowadays, black boxes, one unit, one thing. Calculators were those wonderful things you sat on your desk and then you ground out the answer, you moved the register, ground some more. I think when he said computing engine, he was referring to its different parts that took on different functions. That's a concept we've lost that we'll need to bring back again, because we'll be building systems of computers with different functions. He was right when he called Mark I a computing engine; it had many parts that worked simultaneously together with each other and performed functions."

"Howard Aiken was a tough taskmaster. I was sitting at my desk one day and he came up beside me, and I got on my feet real fast. He said, 'You're going to write a book.' I said, 'I can't write a book.' He said, 'You're in the Navy now.' And so I wrote a book. I have it here with me so that I can answer any questions. This is the Mark I manual, the entire bible for Mark I. You could take this and build Mark I again, if anyone felt like it."



After dinner, Museum Director Gwen Bell and Board Chairman Ken Olsen chat with Board member George Michael.



First Anniversary Dinner and Talk by C. Lester Hogan

May 5th, more than 150 people gathered at the Museum to celebrate its first anniversary with a reception, gala dinner and a talk by C. Lester Hogan. Clark Prestia, the donor of our typewriter collection came from California, G.C. Belden from Rochester, New York, and members of the Board of Directors converged from all directions. Conversations overheard at the reception were, "Oh, my gosh, I haven't seen you since . . ."

C. Lester Hogan, who has been involved with development of semiconductors since his days at Bell Labs in the fifties and early sixties, described the origin and evolution of the semiconductor industry, and gave some insights of a view to the future.



Dr. Hogan congratulates Jamie Parker on the new semiconductor exhibit researched by Hugh Plant and John Breen (background). C. Lester Hogan, past president of Fairchild Camera and Instrument, was responsible for a donation of Fairchild's significant chips and their photographs to the Museum. Under the direction of Jamie Parker, John Breen and Hugh Plant

developed these into an exhibit emphasizing critical steps in the evolution of semiconductors. Breen and Plant, students at Worcester Polytechnical Institute, produced the exhibit and supporting text as their "Interactive Qualifying Project." It received the highest grade from Worcester Polytech and from Dr. Hogan.

April 10: Apollo Guidance Computer Talk

Describing the Apollo Guidance computer at a spring "Bits and Bites" talk are (left to right) Albert Hopkins, Ramon Alonso and Eldon Hall, designers of the on-board guidance computer.



"The Apollo Guidance Computer project was a perfect example of top-down design in which the requirements are set and the job carefully described. The first thing that was decided was how big it was going to be, so Eldon Hall went to North American Aviation and returned with the answer: 'It is this big.' We felt like rookies. We were going to fill a cubic foot with computer and hope it would do the job," Alonso told the "Bits and Bites" audience.

"During the design process we had the opportunity to meet astronauts, most of them Mercury astronauts at the time. They listened to what we had to say, and then they told us, some politely and some not so politely, that the first thing they were going to do was indeed turn it off. In the first place, nobody was going to fly their airplane, in the second place they didn't trust it. But people get used to everything, including computers and spacecraft," Alonso said.

PRAY, MR. BABBAGE . . .

A character study in dramatic form

by Maurice Wilkes

Mr. Babbage's library in his house at 1 Dorset Street, London, is a comfortable apartment, as it needs to be, for he spends much of his time in it. It has the usual trappings of a library, including book-cases, a writing table, and leather armchairs. By the side of the fireplace—which has no fire—is a bell handle of the usual rotary type. The door is at the rear, and on one side of it is a small oval looking-glass in a gilt surround. On the other side there is a just discernible mark on the wallpaper, suggesting that at some time a similar looking-glass has hung there.

The date is 19 November 1856, and Mr. Babbage is 65 years old. His wife died young and for the last thirty years he has lived by himself. His loneliness has been accentuated by the circumstance that his two elder sons have migrated to Western Australia and his youngest son—of whom we shall hear more—is in the service of the East India Company.

As long as anyone can remember, Mr. Babbage has been working on a vast mechanical digital computer—which he calls his Analytical Engine—but has never succeeded in producing anything that would work. In consequence, the world has written him off as a crank, a verdict that history will one day triumphantly reverse. He is given to complain to anyone who will listen that, in spite of having expended much effort and a considerable fortune on the Analytical Engine and on the Difference Engine that came before it, he has received nothing but rebuffs in his own country—particularly from the Government—and that he is better appreciated abroad. Nor is he free from the Victorian failing of indulging in personal vendettas, conducted in print, with those who have crossed his path. However, you would be very wrong if you were to think of him as an embittered and isolated man. Far from it. He is socially a great success. He knows everybody, goes everywhere, and is at no loss for friends. He may dislike being contradicted and may be more than a little pompous in manner, but keep him off his hobby horses and you will find him an entertaining enough companion. However, when we first meet him, it is his number one hobby horse that he is riding.

At this moment, Mr. Babbage is standing in his library facing his solicitor, Mr. Charles Few, who is comfortably seated in one of the armchairs. Mr. Babbage listens, with growing indignation, as Mr. Few reads from a bundle of legal-looking papers.

Editors note:

The Computer Museum presented the premier performance of Pray, Mr. Babbage . . . by Maurice Wilkes on December 10, 1982. It is a character study in dramatic form of Charles Babbage. An English mathematician, 1791–1871, Babbage invented the first programmable computer—the Analytical Engine. Although it was never built, the Analytical Engine was the first computer ever designed. It was a machine without a fixed purpose, designed to do any calculating task the owner wanted it to. Babbage also designed the Difference Engine, an advanced mechanical device for calculating tables of mathematical functions.

Copyright © Maurice V. Wilkes 1983

The play may not be performed without permission. Applications should be addressed to the author care of the Computer Museum.

Characters in order of Appearance

Charles Babbage	
Charles Few	Solicitor
Payne	Manservant
Sir Edward Ryan	Brother-in-law and life-long friend of Charles Babbage
Henry Babbage	Son of Charles
Min	Henry's wife

SCENE ONE

Few: Middlesex. Dominico Beltoni by Thomas Johnson, his attorney, sues Charles Babbage for that the defendant assaulted the plaintiff and gave him into custody to a policeman and caused him to be imprisoned in a certain police station and to be conveyed there in custody through and along divers public streets to a Police Court and to be there a long time, to wit, from Saturday to Monday, further imprisoned. Thereby the plaintiff incurred great expense in procuring his liberation from such imprisonment and has lost divers gains and profits. And the plaintiff claims 50 pounds.

Babbage: Fifty pounds!

Few: That is what he demands.

Babbage: It is preposterous. During the last ten years the amount of street music has so greatly increased that it has become a positive nuisance to a considerable portion of the inhabitants of London. It robs the industrious man of his time; it annoys the musical man by its intolerable badness; it irritates the invalid, and destroys the time and energies of all the intellectual classes of society by its continual interruptions of their pursuits.

Few: I agree with you, Sir, but unfortunately there are many people who don't. Some of your neighbours, I believe.

Babbage: The great encouragers of street music belong chiefly to the lowest classes of society. Of these, the frequenters of public houses and beer shops are the worst. I have obtained an unenviable reputation by my determined resistance to the tyranny of the lowest mob, whose love of the most discordant noises is so great that it insists on enjoying them at all hours and in every street.

Few is about to reply when the manservant enters.

Manservant: Sir Edward Ryan has called, Sir, to enquire when Mr. Henry and Mrs. Henry are expected. He will be happy to wait if you are engaged or could call back later.

Babbage: Ask Sir Edward if he will be good enough to step in. (Manservant goes out) You are acquainted with my brother-in-law, I believe. He is a former Chief Justice of the Presidency of Bengal. His advice will be germane.

The manservant returns and holds the door open for Ryan. Ryan is of exactly the same age as Babbage, and they were at Cambridge together. His long career in public service has given him an easy touch in dealing with people that Babbage conspicuously lacks. Also, he did not have the misfortune to lose his wife at an early age.

Ryan: Good afternoon, Charles. (Sees Few) Good afternoon, Mr. Few. (Shakes hands) (Looking quizzically at Babbage) Mr. Babbage closeted with his solicitor! Organ grinders, I presume.

Babbage: I am the victim of much persecution, Edward, as you know. An Italian musician of the name of Beltoni is demanding 50 pounds damages of me.

Few: Beltoni refused to stop playing and go away when Mr. Babbage desired him to do so. He became abusive and Mr. Babbage fetched a policeman and gave him in charge. The magistrate dismissed the case and found him to be not legally in custody.

Babbage: I despair! This new magistrate has yet to convict anyone I bring before him. His predecessor was bad enough, but this one seems to regard all street music as high art!

Ryan (To Few): Do the Metropolitan Police Acts sanction the giving of a man in charge in these circumstances?

Few: They do not.

Ryan: I do not know whether you want my opinion, Charles, but it seems to me that you will have to ask Mr. Few to make as good a settlement as he can—out of court.

Few: I would certainly urge that as the most prudent course. A present settlement is infinitely cheaper than fighting a case, even if one is likely to win.

Babbage: Well . . .

Babbage, faced with this solid front, pauses to consider, and he may be on the point of agreeing when a barrel organ opens up with "Rule, Britannia" outside his window. He moves in a determined but dignified manner to the fireplace and rings the bell.

Babbage: You see how this intolerable nuisance starts up at the most inopportune moments and destroys all concentration. On a careful retrospect of the last dozen years of my life, I calculate that one fourth part of my working power has been destroyed by it. When my daughter-in-law was in a delicate state of health after the birth of her son, I could do nothing to protect her from incessant annoyance. The present interruption could continue for a protracted period.

He rings the bell again. As he does so, the music stops.

Babbage: (Taking a memorandum book from his waistcoat pocket) Pray excuse me. I keep a careful record of each and every occasion on which I am disturbed. (He writes in the book)

The manservant enters.

Manservant: I crave your pardon, Sir, for not answering the bell immediately, but I thought it would be your wish that I should desire the person to go away.

Babbage: He was abusive, I presume.

Manservant: Well, Sir, not exactly abusive, as you might say. When I offered him a shilling to go away, he merely observed that you did not know the value of peace and quiet, and demanded another sixpence. (He goes out)

Ryan: When you bought this house I seem to remember that the neighbourhood was a quiet one.

Babbage: It was. I chose the house for that reason, and because it had an extensive plot of land on which I could erect the workshop and drawing office I needed for my work on Calculating Engines. Unfortunately, despite all protests, the street was invaded by a hackney coach stand. The immediate consequence was obvious. The most respectable tradesmen, some of whom I had dealt with for five and twenty years, sold their property and left. Coffee shops, beer shops, and lodging houses filled the adjacent small streets. The character of the new population may be inferred from the taste they exhibit for the noisiest and most discordant music.

Ryan: Have you thought of leaving yourself?

Babbage: I may yet be forced to do so. But it would mean the end of my work. Why should I be driven from a house on which I have expended a considerable fortune, and which exactly suits my purposes? I have provided many comforts. For example, soon after com-

ing here one of my first steps was to install Mr. Perkins' patent hot water warming apparatus.

Ryan: Ah, there you have something out of the ordinary. A home that is always comfortably warm, whatever the weather.

Few: I noticed it as soon as I came in. Even the entrance hall is warm. I hope, Sir, you will pardon my curiosity as to how it is contrived.

Babbage: It is very simple. There is a furnace in the cellar, and pipes of welded iron filled with hot water convey heat to the various parts of the house.

Few: The usual function of a fire in causing the air in a room to be renewed does not seem to be missed. I detect no lack of ventilation or odour of burnt air.

Babbage: I agree with you, Sir, that ventilation is of equal importance to heating. Mr. Perkins, by my direction, provided for fresh air to be admitted from the garden and conveyed by ducts to the several rooms; it emerges after being heated by the pipes. My desire was to secure uniform warming and ventilation, with strict economy of fuel.

Ryan: How much fuel do you use, Charles?

Babbage: During the winter of 1838, I caused my servant to keep accurate records. From 30 to 85 pounds of strong coke were consumed in 24 hours, depending on the temperature outside.

Ryan: Certainly the system produces much comfort. I believe the time will come when every gentleman's house of the better sort will be warmed in this way.

Babbage: You understand why I do not wish to leave Dorset Street. In any case, there are street musicians to be found everywhere. I compute that there are no fewer than one thousand of these artists plying their abominable trade in London at any one time. If the Metropolitan Police Acts do not help, is there any other remedy open to an honest citizen?

Few: Well, there is the common law. It would be possible to seek counsel's opinion as to the propriety of applying to the magistrate to state a case for the Queen's Bench. What do you think, Sir Edward?

Ryan: It would be possible, certainly. I would not like to say what the outcome would be. The only thing that is certain is that it would cost you a great deal of money.

Babbage: How much?

Few: I would say about 50 pounds. But in addition, there is Beltoni's action to be defended. I suppose you would wish to have that case heard before a Special Jury. That would cost you 20 pounds, which you would have to pay whether you won or lost. Altogether for the whole affair between 50 and 100 pounds, perhaps near a hundred.

Babbage: No amount of common sense will enable a man to comprehend the laws of England. But it would be good economy to purchase my own time at the expense you mention. Pray take all necessary steps without delay. You will be willing to give Mr. Few the benefit of your advice, will you not, Edward?

Ryan: Certainly. (To Few) You will find me either at the Civil Service Commission near Westminster Abbey or at the Audit Office nearby.

Few: Thank you, Sir Edward. I will call on you as soon as I have drafted a brief for counsel. All is now settled, I think. I will get back to my chambers. Goodbye, Sir Edward. Goodbye, Mr. Babbage.

He shakes hands and goes out. Babbage and Ryan slip into the easy manner of old friends who were at College together.

Ryan: I called hoping to see Henry and Min, Charles, but I gather from your man that you are not expecting them until later.

Babbage: No. They have gone to Folkestone to leave the children with Min's Aunt Rachel.

Ryan: Yes, they told me they were going to do that when they came to see me last week. We said goodbye then, but, as I had an hour to spare, I thought I might catch them again. Min will be miserable at parting with the children.

Babbage: It is very hard on her, but taking them back to India was out of the question.

Ryan: Oh, absolutely. Where they are going in the Punjab is a very inaccessible place, not at all suitable for a baby of one and a little girl of four. They will be able to travel by carriage as far as Uballa, but beyond there they will have to go by doolie, a most uncomfortable form of travel.

Babbage: Yes, Henry has described it to me. A doolie is a variety of sedan chair, is it not, fixed to a pole and carried on men's shoulders?

Ryan: A long box, really; it is big

enough to recline in but, believe me, one is very stiff and worn out at the end of the day. Henry was telling me that he expects to be appointed interpreter to his regiment.

Babbage: Yes. It is very gratifying to me that my son should have been so successful in his profession. It has been entirely on his own merits. I have used no interest whatever on his account. He qualified as an interpreter after less than two years' service in the Indian Army.

Ryan: He is a very good one, too. He coached my son in Hindustani, you remember. (Looks at his watch) I fear I must go now. I have to be at the Exchequer in twenty-five minutes.

Babbage: And I shall just have time to do some work on my Analytical Engine. My workmen will need fresh instructions tomorrow.

Ryan: Ah, there you have something that interests you. I sometimes wish I had kept to science instead of turning to the law when I left Cambridge.

Babbage: (Grimly) You would have been poorer for it.

Ryan: I suppose I would. Our fellow student, John Herschel, did not do too badly, though. But then he was Senior Wrangler; that makes a difference. Goodbye, Charles. Give my good wishes for their journey to Henry and Min. (He turns to go but looks back) By the way, what was that question you were asked? Pray, Mr. Babbage, if you put the wrong figures into your machine, will the right answers come out? By a Member of Parliament, too! (He goes out chuckling)

When Ryan has left, Babbage goes to his writing table and begins to spread out some large sheets of paper. A thought strikes him, and he crosses to the fireplace and rings the bell. He returns to the writing table and starts to work. The manservant comes in.

Manservant: You rang, Sir?

Babbage: Yes. Mr. Henry and Mrs. Henry are leaving early tomorrow morning. We shall require an early breakfast—say six o'clock.

Manservant: Very good, Sir. (He prepares to leave)

Babbage: Oh, and Payne—

Manservant: Yes, Sir?

Babbage: Be sure to go for a cab in good time. I shall accompany Mr. and Mrs. Henry to Waterloo station and see them into the train.

Manservant: Very good, Sir.

Babbage settles to work, writing on one of the sheets while referring to the others. Very shortly, the noise of a hackney cab is heard and it is clear that Henry and Min are arriving. Babbage gives a sign of annoyance at having his work interrupted. He continues, and after a few moments Henry comes in. As might be expected of an officer in the service of the East India Company, Henry, who has recently celebrated his 32nd birthday, has a soldierly bearing, although he is lightly built and of medium height.

Babbage: You are earlier than you said you would be, Henry.

Henry: Yes, the train left sooner than we thought. Min has gone to take her coat off. She will be down in a minute. (Seeing the work on Babbage's table) I am afraid I interrupted your work, Sir.

Babbage: I was working on the notation for my new method of multiplication by means of precomputed multiples—the one we talked about before you left. I am not sure even now that I have achieved the best possible, but you will see that I now take three fewer turns of the hand than before. (Putting the paper he had been working on in Henry's hand, he goes out on some brief errand, leaving the library door open. Henry studies the paper with signs of approval as he proceeds.)

Min enters. She will be 23 in a few days' time, having been only 18 when Henry met her on a river steamer in Central India and married her in the garrison church at Mirzapur shortly afterwards. She is, as we shall see later, a true Memsahib. At present, however, as she stands in the doorway, she looks very young and helpless.

Henry: (Going to her) Are you all right, Minnie?

Min: Yes, but I have just been up to the nursery. How empty it is! Oh, Henry!

Henry just has time to squeeze her hand and give her what comfort he can before Babbage returns.

Min: Never mind. I shall be all right.

She pulls herself together, and no-one would know what she is feeling.

Babbage: Ah, there you are, my dear. (He takes her hands in his) Back just in time to say goodbye! If only you were not leaving tomorrow. (It is obvious that he is very fond of her, although he does not quite know how to show it)

Min: Yes, it is sad we are leaving. The time had to come, I suppose. I have been so happy here. Thank you for everything. The nursery with so many conveniences, and—

Babbage: You have put me in your debt. It is a great boon that you have conferred on me—both of you—by coming and joining in all of my pursuits. I shall be very miserable when you have gone.

Min: You have done so much for us.

Babbage: And it has given me great satisfaction that my son should have entered so fully into my work.

Henry: If only I could have found some feasible way of leaving the Indian Service and staying in England! I could find nothing tempting enough, or certain enough, to entertain, especially as we now have the children to think about.

Babbage: Yes, I too had hoped . . . It is hard to believe that I shall not have you and the children with me anymore. At any rate, they will be well looked after. They will be under the eye of your aunt, and you have every confidence in Jane. You need not worry about them in any way. (To Henry) You remember the time when Jane came running downstairs to tell us Harry had been born? We were at dinner.

Min: (Half to herself) It was just a year ago.

Henry: Yes, how glad we were that it was a boy. I shall be eligible to apply for a Civil appointment later this year. If I could contrive to be posted to one of the larger stations, it might be possible for the children to join us. It would be out of the question where we are going. The journey, for one thing . . .

Babbage: It would be a great convenience to you if the new railway from Calcutta to Delhi were open.

Henry: Yes, it would, indeed. Min and I have just been talking about it. I was telling her of the deep interest you took in railways when I was still a boy.

Babbage: (To Min, eagerly taking up the topic) Yes. I naturally became interested at the commencement of the railway system, not only for its bearing on mechanism, but also for its bearing on political economy.

Min: Henry told me that you did some experiments on the Great Western Railway.

Babbage: Yes, I did. It was the wish of Mr. Brunel and the directors that I should give my opinion on the question of the gauge, and I felt that I could not speak with confidence without making certain experiments. The directors put at my disposal a disused second class carriage which I fitted up with recording apparatus.



Henry: And the experiments confirmed you in your view that the broad gauge was to be preferred.

Babbage: They did. I have been told that the statement I made at a meeting of the proprietors held at the London Tavern had a considerable influence on their decision to adopt the broad gauge.

Min: That was the 'battle of the gauges,' wasn't it?

Babbage: Yes. Strong feelings were held on both sides. The battle has long since been won by the standard gauge, as it is now called.

Henry: Do you wish, Sir, that you had advised the Great Western Railway in the opposite sense?

Babbage: No, I do not. It is still my decided opinion that all the advantages of economy of management, as well as of safety, lie with the broad gauge.

Henry: But the inconvenience and expense of converting to the narrow gauge has been great.

Babbage: True, but at the time no one could foresee that Mr. Stevenson's influence in favour of the narrow gauge would prevail.

Henry: He was the father of the railways, when all is said. I would have ought . . .

Babbage: (Who does not like being contradicted) I have given you my opinion. Even a few inches more than 4 feet, 8½ inches would have been preferable. Mr. Stevenson himself admitted as much to me at the British Association meeting in Newcastle.

Henry: His son has adopted 5 feet, 6 inches for the Calcutta railway. That is quite a lot more—9½ inches.

Babbage: It is certainly an improvement.

The manservant enters.

Manservant: Excuse me, Sir. Mr. Wight was hoping that you would have time to go to the workshop before he leaves.

Babbage: Oh yes, I will go now. Perhaps you would like to come too, Henry. I think that you would be interested in my latest experiment.

Henry: I am sure I would, Sir. I will come along directly.

Babbage goes out.

Min: It has been a wonderful three years furlough. We have done so many things, seen so many people, haven't we?

Henry: Yes, we can indeed look back

on it with pleasure and satisfaction. I have lost time for my pension, and we have spent some of our savings, but it has been well worth it.

Min: And yet, when we left India, you were by no means sure that it would be agreeable to your father to have us in his house.

Henry: No. During my furlough I have met him on more equal terms than ever before. As a boy I feared him, and often left the house to avoid meeting him.

Min: That was when you lived with your grandmother?

Henry: Yes. She was much affected when I left for India. My father said goodbye to me here in his library and did not even come down to the cab. I could not help contrasting my experience with that of another cadet travelling in the same ship. His father went down to Portsmouth to see him aboard. Still, I did learn to respect my father during that period, and earning his approval became important to me. It was with great satisfaction that I wrote to tell him that I had qualified as an interpreter.

Min: You have done other things to please him while you have been here, Henry. For example, the drawings of the Swedish Difference Engine that you took to the British Association meeting at Newcastle.

Henry: I wish I could do something to make my father's work on calculating machines better understood. People confuse the Analytical Engine with the Difference Engine.

Min: It is a pity that the Difference Engine was never completed.

Henry: Yes, people naturally criticise my father for abandoning it. But it was a big advance that he had made in going to the Analytical Engine.

Min: But when the government had spent so much on the Difference Engine, it should have been completed. Surely the disagreement your father had with Mr. Clement, his engineer, could have been overcome.

Henry: Yes, you are quite right. But anyone who properly understands the principles on which the Analytical Engine is based can hardly doubt its value to science as a whole—whereas the Difference Engine—

Min: But how many people do understand the Analytical Engine?

Henry: Not many, it is true. And there are many practical problems still to be overcome in its construction.

Min: Will your father succeed in completing it, do you think?

Henry: He still has a long way to go. The important thing is that he should go far enough for others to be able to continue the work. I wish he would publish a full account of the various principles and contrivances that he has evolved.

Min: The memoir by Menabrea that Lady Lovelace translated and annotated does not go far enough?

Henry: No, and it does not make easy reading.

Min: Have you suggested to your father that he should prepare a full account?

Henry: I have several times resolved to do so, but I have felt diffident about approaching the matter.

Min: Yes, I understand that. But if you do not say something you will regret it later. Perhaps you could take an opportunity tonight when I have gone to bed. I shall go early in any case.

Henry: You are right, I should. I have felt very close to my father during these last months. He took to you, too, Min, at once. You remember the looking glass he placed on the sideboard so that during dinner he could see you in it without looking in your direction? It is still there.

Min: Yes, I had to pretend not to notice it. I took to him too, Henry. He is a bit of an ogre in some ways, but underneath very nice and very sincere. I suppose that is why he has so many friends, and goes so much into society.

Henry: It is unfortunate that he has also made some enemies. He is apt to take an unfortunate view of other people's actions and motives. When he does he feels that he must expose them in strong terms.

Min: (With a little laugh) As far as strong terms go, he has met his match in the Reverend Charles Sheepshanks. What was it he said in his pamphlet about Mr. Babbage's blundering pertinacity?

Henry: He attributed it to a diseased mind! He also said that my father was ill-natured.

Min: Oh, that he never is. How could anyone say that he is ill-natured?

Henry: My mother's dying when I was a baby had a lasting effect on him. He has lived alone all these years.

Min: How glad I am we named Georgie after her, Henry. I am sure it gave him pleasure. (The thought of her little girl

causes her grief to come flooding back) Oh Henry! When will we see her again?

He goes to comfort her, but there is nothing he can say. She abandons herself to grief for a moment, but then remembers who she is, and the stern duty that fate has laid on her.

Min: I can bear it. Separation from her children is something that all women in my situation must endure. (She pulls herself together and moves away from him) I must talk to Payne about the things that were to be sent to Folkestone. You ought to join your father in the workshop.

Henry: Yes, you are right. I will send Payne to you.

He looks tenderly at her, half hesitates, and goes out. Left alone, she goes over to the looking-glass, wipes her eyes and tidies her hair. She is quite composed when the manservant comes in.

Manservant: You wanted to see me, Madam?

Min: Yes, it was about the children's clothes.

Manservant: They are packed and all ready to be sent off, Madam. The housekeeper asked me to say that she has given away the clothes the children have grown out of.

Min: That is very kind of her.

Manservant: Will you permit me to say, Madam, that all of us downstairs wish you a good journey back to India.

Min: Thank you. I fear that you must have had much extra work during the last three years. We are very grateful to you for all you have done for us.

Manservant: It has been our pleasure, Madam. This old house has been a different place with children in it. I hope Jane will bring them to see us sometimes.

Min: I am sure she will.

Manservant: Perhaps you and Mr. Henry will be coming back, Madam?

Min: We would like to, of course. But India is a long way off, and travel is so very difficult.

Manservant: Yes, Madam. Seeing that I was interested, Mr. Henry described it to me, and showed me on the map where you are going. Will there be anything further, Madam?

Min: No, nothing more, thank you Payne.

SCENE TWO

A lamp is burning on the library writing table and the manservant is in the act of lighting another on the opposite side of the room. Babbage enters, followed by Henry.

Henry: You will excuse Min, Sir, for going to bed so early. She is feeling miserable at leaving, and we have to get up early tomorrow.

Babbage: We were all three miserable at dinner, I fear.

Henry: (Picking up some small objects from the writing table) I presume that these are the results of your latest experiments in casting small wheels, or rather in moulding them under pressure.

Babbage: Yes, they are. It is very necessary to my plan that I should have the means of making large numbers of identical parts cheaply and with precision.

Henry: (Putting the wheels down and resolving to approach the matter that is on his mind) May I ask, Sir, whether you have plans for adding to what is already in print about the Analytical Engine?

Babbage: No. The memoir by Menabrea and the notes that Lady Lovelace appended to her translation of it fully dispose of the mathematical aspects of the engine.

Henry: But the details of the mechanism? I could wish that you would write more on that subject.

Babbage: I have not the time.

Henry: It would be unfortunate if a future generation had to rediscover what you had learnt.

Babbage: My best means for ensuring that they do not is to complete the engine.

Henry: But the engine itself will only exhibit the one system you have decided to adopt. A critical discussion of the various possibilities you have considered, and your reasons for proceeding as you have done, would be of interest to many people.

Babbage: I can hardly undertake to discuss all my rejected arrangements until I have shown that the one I have chosen will meet the demands put upon it.

Henry: So you do not feel disposed to add to what has already been published?

Babbage: Not at present. At a future time, perhaps.

Henry: I must, indeed, agree with you that the Memoir and Notes give very full information about the mathematical use of the engine—that is, to those who are willing to give them the necessary study. I could wish that more men of science had done that.

Babbage: English men of science you mean! I have been entirely without recognition in my own country. The Commissioners for the Exhibition of 1851 ignored the Difference Engine and its inventor. As for the Analytical Engine, I have received no return whatever for the time and energy I have expended on it.

Henry: I know you feel that you have been unjustly used in regard to your work.

Babbage: A report persistently circulates to the effect that I abandoned the Difference Engine in order to proceed with the Analytical Engine. That is entirely false as you know. The Chancellor of the Exchequer himself gave the true reason, namely, expense. Nor did I quarrel with Clement as some have suggested. I considered his demands to be exorbitant, but I never said or wrote an unkind word to him.

Henry: It was shortly after I arrived in England that Mr. Sheepshanks published his infamous pamphlet.

Babbage: As long as such charges are confined to the Reverend Richard Sheepshanks' pamphlet, they have no effect. It is a different matter when they appear in the public print. I had recently to write to the Morning Chronicle denying a report that had appeared in that paper.

Henry: I met Mr. Sheepshanks, you will remember, at Greenwich. You took me with you on the Admiralty barge when you went to attend a meeting of the Visitors.

Babbage: What impression did you form of him?

Henry: Oh, he was agreeable enough.

Babbage: He can be on social occasions. I was unfortunate to be opposed to him in the arbitration concerning the Equatorial Telescope made by Troughton for Sir James South.

Henry: That must have been a disagreeable case for you to be involved in.

Babbage: It was. I had at first refused to be a witness on behalf of Sir James. However, the late Lord Abinger represented to me that my evidence was necessary to the justice of the case. Otherwise, I would have persisted in my refusal.

Henry: Mr. Sheepshanks was a witness on the other side?

Babbage: He was more than that. He had studied the law after taking his degree at Cambridge. It was curious to see the energy and vigour with which he applied himself to the exercise of his youthful studies.

Henry: You mean he took charge of the case for Troughton?

Babbage: He did. But that is not all. After I had given my evidence—but before I had been cross-examined on it—he took occasion to say that because I supported Sir James, I must be discredited. He went on to threaten to attack me publicly on another subject at a future time.

Henry: That sounds like tampering with the witness.

Babbage: Exactly. I felt that it would be unsafe for the cause of justice—and possibly injurious to myself—if I did not take measures for making known the nature of the weapons that the Reverend Richard Sheepshanks was employing.

Henry: That was why you denounced him in your book.

Babbage: Yes. His pamphlet was his reply.

Henry: I can understand his wanting to make a reply, but I think he went rather far in his personal attack on you.

Babbage: Let my detractors say what they will. If I survive some years longer, the Analytical Engine will exist, and its works will be spread over the world. Soon copies will be made, and there will be an Analytical Engine in every capital. They will be in constant employ for investigations in which profound analysis is necessary.

Henry: Yes. I realize that calculating machines are not for doing ordinary sums in arithmetic—nor for use by vendors of vegetables and little fishes—as Leibnitz put it. But what would you say are the limits of the Analytical Engine viewed as an automaton?

Babbage: The Analytical Engine itself is confined to calculation. But the same principles could be used to construct automata for other purposes.

Henry: Games of skill, for example.

Babbage: Yes. At one time I gave much thought to that subject for its philosophical interest.

Henry: We have talked about tit-tat-to, or noughts and crosses, as it is called.

Babbage: That is the simplest of such games. It is easy to make a machine to

play it and always to win, when winning is possible under the rules.

Henry: In a game like chess, however, the number of combinations is enormously greater, and foresight is required.

Babbage: That is so. But I have, after all, devised for the Analytical Engine means equivalent to foresight, and even allowing a hundred moves for a game of chess, the number of combinations available in the Analytical Engine greatly exceeds what is required. I believe that the principle on which the Analytical Engine is based would allow the construction of an automaton capable of playing chess.

Henry: Perhaps such an automaton will one day be built.

Babbage: Possibly, but it is hard to see why anyone should want to do so. There would be little profit in it. I am told that even the machine for writing Latin verses was an entire failure from a pecuniary point of view. The most profitable exhibition which has occurred for many years is that of General Tom Thumb, the American midget.

Henry: We are truly fortunate to live in a time of such progress: steamships, railways, the electric telegraph . . .

Babbage: I would gladly give up the remainder of my life if I could come back for three days in a hundred years' time and have some competent person explain to me the discoveries that had been made.

Henry: I am about to make a journey back into the past. India so far has hardly felt the march of progress.

Babbage: That will come.

Henry: (Looking at his watch) I think I should say good night now, Sir. My furlough has been profitable to me in many ways. Not least has been the privilege of being present when the Analytical Engine was coming into being.

Babbage: My fear is that I shall be called to my account before I have accomplished my plan.

There is no self-importance, no illusions about him now, as he speaks, half to Henry, half to himself, the simple truth.

Babbage: It must be that one day some person will succeed in doing what I have set out to do. He may employ different mechanical means. He may call his machine by some different name. But he and he alone will be capable of appreciating the nature of my efforts and the value of their re-

sults. I shall have no fear of leaving my reputation in his hands.

Henry: You can be sure of having the acclaim of posterity, Sir. I pray that you may be spared long enough to receive it in your lifetime. Good night.

Babbage: Good night, Henry.

Henry goes out. Babbage pauses for a moment and then goes over to his writing table and begins to spread out his papers. He is just sitting down when a thought strikes him. He goes out and shortly returns carrying a looking-glass which he puts back in its old place on the wall. He then settles to work.

THE END

The Founders Program

The Computer Museum Corporate Founders

American Federation of Information
Processing Societies, Inc.
Apollo Computer, Inc.
Association for Computing Machinery
Benton and Bowles
Bolt, Beranek and Newman
Boris Color Labs
British Computer Society
Robert Cipriani Associates
Clint Clemens
Codennoll Technology Corporation
Computer Sciences Press
ComputerWorld
Control Data Corporation
Convergent Technologies
Coopers and Lybrand, Boston
Data General
Dataproducts Corporation
Digital Equipment Corporation
Digital Equipment Corporation
Users Society
Ford Motor Company
Fujitsu Limited
General Systems Group, Inc.
IEEE Computer Society
Intel Corporation
International Telephone and Telegraph
Corporation
MDB Systems, Incorporated
MITRE Corporation
Motorola, Incorporated
OMNI Publications International, Ltd.
Richard Reno
Schlumberger Foundation
Seldin Publishing
Software Results Corporation
Tobin Vending Service
The Travelers
Wang Laboratories

New Individual Founders April 12 through July 12, 1983

Ken R. Adcock
John Alexanderson
Kendall Allphin
Jean-Loup Baer
Steve F. Barnebey
Jordan and Rhoda Baruch
Jeffrey Bernstein
Lamar C. Bevil, Jr.
John G. Brainerd
Walter M. Carlson
Alan Chinnock
Donald D. Clark
Fernando J. Corbato
Kent and Herta Curtis
Philip H. Dorn
A. S. Douglas
Ray Duncan
Dean Elsner
Lucian J. Endicott, Jr.
Richard and Stephen Etzi
David J. and GG Farber
Edward A. Feigenbaum
Mary Jane Forbes
Willard H. Gardner
Donald A. Gaubatz
J.M. Shag Graetz
John E. Griffith
Alain Hanover
Frank E. Heart
William Hunzeker
Aron K. Insinga
Alan Jeddelloh
Howard W. Johnson
William Keating
Francis W. Keller
Mary Jo Kostya
Benjamin Kuipers and Laura Lein
Hal Lamster
Richard Lary
John Laynor
Henry M. Levy
Arthur Luehrmann
Edward Luwish
Robert H. Matthews
Robert Mayer, Jr.
Tron McConnell
Henry McGilton
Hugh McGinness
R. W. Meister
William F. Miller
Charles R. Minter
Reg S. Mitchell
Robert Moe
Reade B. Nimick, Jr.
Bernard Nordmann
Anthony G. Oettinger
Adam Osborne
Kenneth D. Patterson
Linda J. Phillips
Gerard Piel
Andrew Plescia
Nicholas Reinhardt
David and Linda Rodgers
Martin S. Roth
Richard Rubinstein
Andrew Scott
Aaron Seidman
Marc Shulman
Dan Siewiorek
Norwood Sisson
Daniel P. B. Smith
Seth Stern
William M. Steul
J. Michael Storie
Erick N. Swenson
Robert W. Thornton
Jerome Vuoso
Christian Walker
Wendell Weatherford
Lih J. Weng
Christopher Grey Westbury
John D. Wick
George H. Williams
Niklaus Wirth
William Wulf
D. L. Wyse

The Computer Museum Bits and Bites

Bits of history and bites for sustenance

Nine Sunday Afternoons

At 2 pm, guided tours covering highpoints of the Museum

AT 3 PM . . .

September 18
3 pm

Kurzweil Reading Machine, a reader for the blind demonstrated by its engineers.



"The greatest thing since Braille." Kurzweil's Reading Machine reads printed material aloud. An electronic scanner with a speech synthesizer, it can identify 200 different typefaces and is programmed with 1000 linguistic rules and 2000 exceptions.

September 25
3 pm

Joseph Hammond on the Evolution of Multiwire Technology and Its Impact on Computer Packaging

In 1966, Hammond and others designed the first machine to automatically wire printed circuit boards. It and subsequent multiwire wiring machines have dramatically altered computer packaging.

October 2
1-5 pm

The Computer Museum Yard Sale

Overstock memories, disk drives, consoles and even computers from the Museum's collection will be for sale. Cash and carry only; no deliveries. Browsers welcome.

October 9
3 pm



R. Michael Hord on the Iliac IV

Iliac IV, displayed in the Museum's supercomputer gallery, was the biggest and fastest machine of its time—a 96 ton giant capable of 300 million operations per second. Hord is author of *Iliac IV, The First Supercomputer*.

October 16
3 pm

Perry Crawford on Vannevar Bush and the Whirlwind

Bush's differential analyzer provided the inspiration for the Whirlwind, and Crawford followed the evolution of both at MIT.

October 23
3 pm

Robert V. D. Campbell on the Harvard Mark I-IV



A multi-media presentation on these revolutionary computers designed at Harvard presented by Campbell, one of the designers involved with the project from the Mark I on.



October 30
3 pm

Andries Van Dam presents a Graphical History of Computer Graphics

The progress of interactive computer graphics explored through film and video clips by van Dam, author of *Fundamentals of Interactive Computer Graphics*.

November 6
3 pm

Mike Kryskow on the Development of Telecommunications

A telecommunications engineer, Kryskow will explore the phenomenal growth of networks. Telecommunications networks now link continents, cities and businesses, simplifying everything from banking to weather reporting.

November 13
3 pm



Jack Dennis and John McKenzie on the TX-0 in Action

An inside perspective and demonstration of the TX-0, the first full-scale transistorized computer and a Computer Museum exhibit. McKenzie and Dennis worked on the TX-0 and its expansion during its 18-year reign at MIT from 1956 to 1974.

A newsbrief of the collection

While driving home from work one evening in the fall of 1966, R. Page Burr (now a senior scientific officer at Kollmorgen Corporation) envisioned a way to improve interconnections on printed circuit boards. Connections were originally made by hand placing and soldering discrete wires. Mr. Burr's improvement consisted of copper lined holes interconnected by insulated wires. Interconnection devices of almost any complexity could be made because the insulated wires would be able to cross.

Mr. Burr's idea evolved into the Multiwire Wiring Machine. Pictured is the tacking head from the first production wiring machine, a donation to The Computer Museum by PCK Technology, a division of Kollmorgen Corporation.

**The
Computer
Museum**

One Iron Way
Marlboro
Massachusetts
01752

Non-Profit
Organization
U.S. Postage
PAID
Marlboro, MA
Permit No. 46

THE COMPUTER MUSEUM REPORT

WINTER 1983/84

combines the
reliability it is
le hitherto
ence. Thus it
electronic

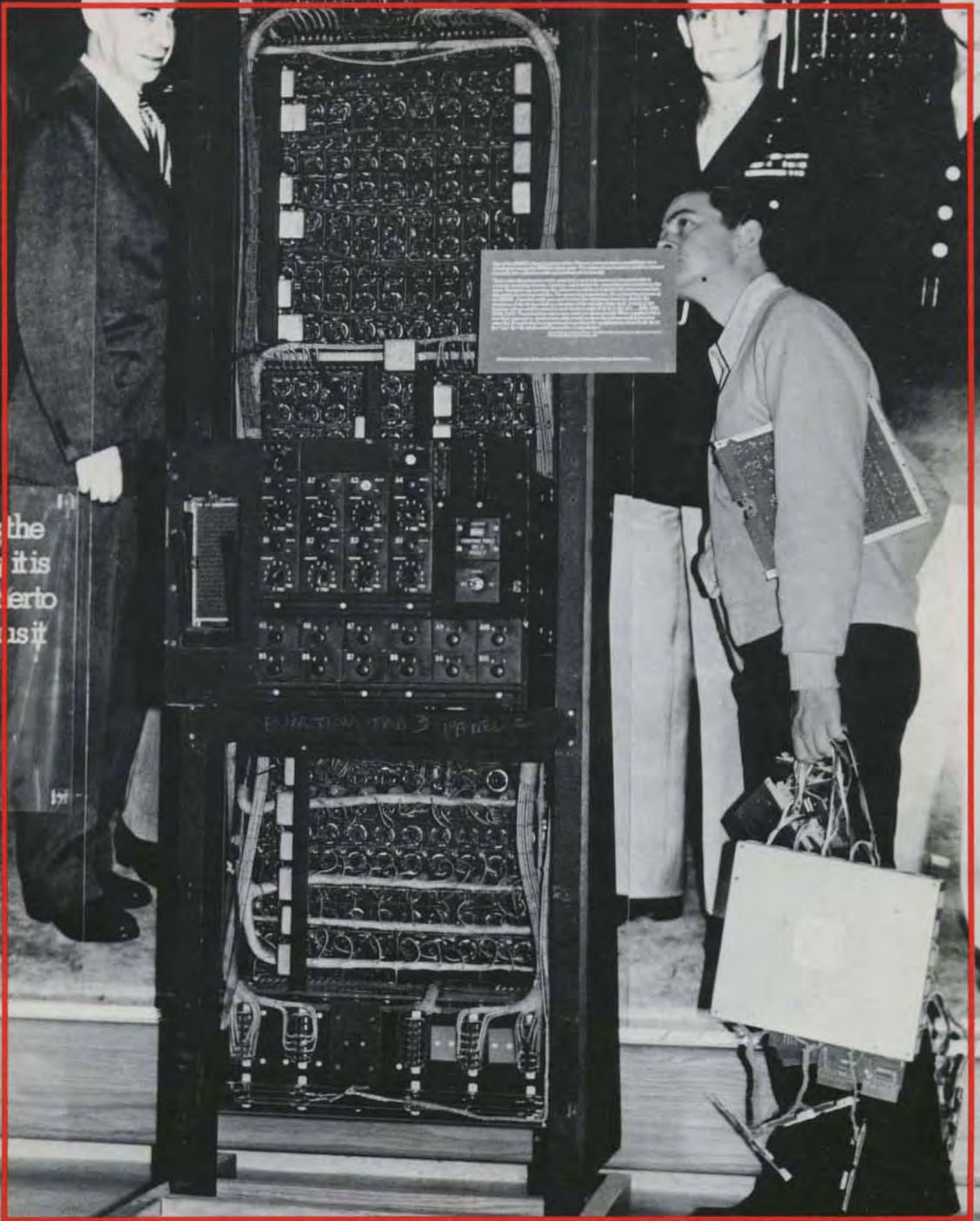

Contents

- 1 The Director's Letter
- 2 Computers: A Look At The First Generation
- 8 The Core Process
- 10 Alan J. Perlis Lecture: Evolution of Software Programming
- 13 Bits and Bites
- 14 Member Tour
- 15 Yard Sale
Member Coupon
- 16 The Computer Museum Slides
1984 Computer Era Calendar
- 17 Founders
The End Bit

THE COMPUTER MUSEUM

The Computer Museum is a non-profit, public, charitable foundation dedicated to preserving and exhibiting an industry-wide, broad-based collection of the history of information processing. Computer history is interpreted through exhibits, publications, videotapes, lectures, educational programs, and other programs. The Museum archives both artifacts and documentation and makes the materials available for scholarly use.

Museum membership is available to individuals and non-profit organizations for \$25 annually and to businesses for \$125 annually. Members receive the quarterly Report, invitations to all lectures and special programs, new posters, and a ten percent discount in the Museum store.

A Founders program is in effect during the initial two-year period of the Museum, until June 10, 1984. During this period individuals and non-profit organizations may become Founders for \$250 and businesses and charitable Foundations may become Founders for \$2500. Founders receive all benefits of membership and recognition for their important role in establishing the Museum.

The Computer Museum is temporarily closed in preparation for its move to Boston. It will reopen at Museum Wharf in downtown Boston in fall 1984. For more information, call (617) 467-4036.

THE COMPUTER MUSEUM REPORT (ISSN 0736-5438)

The Computer Museum Report is published quarterly by The Computer Museum, One Iron Way, Marlboro, MA 01752. Annual subscription is part of the membership of the Museum (\$25 per year for individuals and nonprofit organizations and \$125 for corporations).

The purpose is to report on the programs and exhibitions of the Museum. The contents of The Computer Museum Report may not be reproduced without written consent.

The Museum Staff is responsible for the contents of the Report. The opinions expressed do not necessarily represent those of The Computer Museum or its Board of Directors.

The design and production of the Report is done by Benson and Clemons.

STAFF

Director

Gwen Bell

Administration

Geri Rodgers, Coordinator

Pat Maguire

Communications

Stephanie Haack, Coordinator

Brenda Erie

Exhibits and Archives

Meredith Stelling, Coordinator

John McKenzie

Beth Parkhurst

Gregory Welch

Bill Wisheart

Membership

Eileen Gardiner, Coordinator

Programs

Christine Rudomin, Coordinator

Store

Carol Strecker, Coordinator

Sally Askins

Linda Davidson

Merle Insignia

Bill Meany

BOARD OF DIRECTORS

Kenneth H. Olsen, Chairman
Digital Equipment Corporation

Charles W. Bachman,
Chairman, Executive Committee
Bachman Information Systems

C. Gordon Bell
Encore Computer Corporation

Gwen Bell
The Computer Museum

Erich Bloch
International Business Machines

Harvey D. Cragon
Texas Instruments

David Donaldson
Ropes and Grey

Robert Everett
The MITRE Corporation

Sydney Fernbach
Computer Consultant

C. Lester Hogan
Fairchild Camera and Instrument Corporation

Theodore G. Johnson
Digital Equipment Corporation

Andrew C. Knowles III
Lexidata Corporation

John Lacey
Control Data Corporation

Pat McGovern
ComputerWorld

James McKenney
Harvard Business School

George Michael
Lawrence Livermore Laboratories

Robert N. Noyce
Intel

Brian Randell
University of Newcastle-upon-Tyne

Jean E. Sammet
International Business Machines

Edward A. Schwartz
Digital Equipment Corporation

Kitty Selfridge,
Chairman, Members Committee
Henco Software, Inc.

Michael Spock
The Children's Museum of Boston

Erwin Tomash
Dataproducts

Honorable Paul E. Tsongas
U.S. Senator, Massachusetts

The Computer Museum
One Iron Way
Marlboro, Massachusetts 01752
617-467-4036

© 1983/THE COMPUTER MUSEUM

Photo Credits:

Phil Rosen pp., 3, 4, 13, 14, 15 and cover

David Bromfield pp., 1, 6

Harvard University, Craft Photo Lab p. 2

The Director's Letter

The Museum is in a time of change: location, staff and exhibits. But our plan is to keep this Report in its familiar form enabling us to communicate our activities to you.

One of the greatest changes has been the departure of Jamie Parker, the Museum's first employee and developer of all the exhibits. She left in August to get married and join her husband in Geneva. In her four years with the Museum, she used her photographic memory to conceptualize exhibits. Jamie had an intuitive feeling for the artifacts and how they could be exhibited even though her education was in art history not computer science. While with the Museum, she cataloged and put three times as much in the warehouse as we had on the floor. One of Jamie's last chores was to organize our yard sale.

The yard sale allowed Jamie to weed our "warehouse." In her first years, she accepted everything because that was her job. The Museum ended up warehousing a number PDP-12s, 338 display systems and PDP-6s. Since Jamie knew what was what and what was best, she selected the items to sell, thus cutting down our storage costs and providing the members with a good day of poking through old junk and taking apart computers. The cover photo is a tribute to Jamie: one of the yard sale customers is carrying off his loot and inspecting the display of the ENIAC, an exhibit put together by her.

A new crew of exhibit and archives employees will help us plan the space for Museum Wharf. Meredith Stelling has taken over as the Coordinator. She has been with the Museum for a year handling publications and archives. Meredith, Greg Welch and Bill Wisheart are the main exhibit staff and will be joined in January by Oliver Strimpel, on leave from The Science Museum in London.

In September, the new space at the Wharf seemed vast and barren, except for chalk marks on the floor indicating where the new exhibits would be positioned. But the space is already beginning to fill out with two truck loads of the SAGE (30,000 pounds), an IBM 1401 card system and a collection from the University of Illinois.

Reviews of exhibit plans started in September. Sheila Grinnel, developer of ASTC's travelling "Chips and Changes" exhibit, Bruce McIntosh, a designer, and Paul Tractman, senior editor, *The Smithsonian*, spent a day consulting on the proposed organization. Then on October 13th, board members **Brian Randell and consultant Dick Eckhouse reviewed** the next iteration.

Successive refinements bring our plans in line with reality. The SAGE system will form the fulcrum of the exhibits leading into the computer generations on one floor, and backward in time to the revolutionary one-of-a-kind computers on the other. The process of moving has now started and the enormity of the task ahead is clear. But the team is together and progress can be seen.

Gwen Bell
Director



Jamie Parker



Harvard Mark III. Magnetic drum storage was pioneered on the Harvard Mark III. The drum rotated at about 3,600 rpm and its random access time was 17 microseconds. By modern standards that was quite slow, however, it was the only way to have moderately priced memory in any quantity in the early 1950's. With its tapes and plug boards the Harvard Mark III covered 40 square feet, and was one of the first hard-wired assemblers that transformed mathematical symbols into machine code.

Computers: A Look at the First Generation

In 1955, Martin Weik compiled a *Survey of Domestic Electronic Digital Computing Systems*, providing a remarkable snapshot of the computer population. The survey briefly describes and gives specifications for about 100 different machines in existence as of December 1955.

Weik's inventory supplied the base to compile a fundamental reference for collecting and research at The Computer Museum. Records for each machine were gathered from contemporary historical accounts in recent books and journals, operating manuals, and in some cases the machines themselves. Then the findings were checked against those appearing in Weik's original survey.

This research was done by Paul E. Ceruzzi, assistant Professor of History at Clemson University with the aid of Rod McDonald of Rider College, and Greg Welch of The Computer Museum. Different specifications and descriptions have been given to the same machines over time for various reasons. Rather than arbitrarily selecting one description, the data was collected and explained.

These differences occurred for a variety of reasons. Specifications given in one account often do not agree with those given in another, because a computer's characteristics usually changed from the time of its early design to its final days of operation. The characteristics of some were entered after they had been redesigned and rebuilt, (e.g. SEAC) and others before such redesign (e.g. Johnniac). Nomenclature was also a problem—one manufacturer's "rapid access registers" might be another's "accumulators"—these differences were reconciled through research.

Different metrics were often used for speed: the time it took to fetch a number from memory in a drum machine may have been given as the fastest possible, the slowest possible, the average, or the fetch time using optimum coding techniques. A time frame for each machine was established to provide a subjective though reasonable assessment of its historical significance.

The first phase of the survey is complete: the data is stored on disks, and printouts are available for scholars. The next phase is to build the collection, define additional research topics and to develop a very accurate map of computing up to 1955.

Gwen Bell

What did computing look like during its "first generation"—the time from the dedication of ENIAC in 1946 to the mid-fifties?

The variety was astonishing. Experimental one-of-a-kind computers, each with its own unique character, ruled, even though most incorporated vacuum tubes and drum memories, stored programs and data internally, and communicated via Flexowriters.

While most were built with vacuum tubes, many also used relays and crystal diodes.

For memory, they relied on delay lines, cathode ray tubes, drums, magnetic tape loops, paper tape, punched cards, magnetic wire, and toward the end of the period, magnetic cores.

For input and output, they used teletypes, punched cards, other paper tape readers, and CRT displays as well as Flexowriters.

Their sizes ranged from that of a small desk to several large rooms full of equipment bays with consoles one could walk into. And their speed ranged from one to tens of thousands of operations per second.

Preliminary Findings: Technology

Most first-generation computers did use vacuum tubes, but not all in the same way. After ENIAC's dedication, designers saw the advantage of tubes for speed, but sought to minimize their number. Those computers used fewer tubes in their circuits, and thus were more reliable and compact. Solid state diodes, not tubes, performed logical operations. This was pioneered in SEAC in 1950, after which only a few computers, such as the Circle and Monrobot, continued to use tubes for logic as ENIAC did.

Between 1946 and 1955, at least a dozen relay computers were built, an indication that some designers did not agree with the prevailing view of the superiority of vacuum tubes. One such person was Howard Aiken, who on visits to Continental Europe in the 1950's influenced the choice of relays for several computers. Konrad Zuse's computer company also produced a line of successful relay computers installed mainly in Continental Europe. Some of the relay computers, like the Bell Labs 5 and 6, were based on se-



Drum from the English Electric Deuce. Built in 1957, the Deuce drum stored $8K \times 32$ -bit words on 256 tracks of 32 words each. It measured four inches by six inches; most first-

generation drums were eight to 20 inches in diameter and two to four feet in length. The Deuce drum is on exhibit at The Computer Museum.

quence calculator designs of a decade earlier. Others, like ERA's "Abel" and the British "ARC," were designed along the lines of stored-program electronic computers, but used relays to save money or to get a prototype working quickly.

By late 1955, a few transistors already were finding their way into computer circuits: in Bell Labs' TRADIC, the IBM 608 Calculator, and perhaps one or two others.

Memory

A wide range of memory devices were used in first-generation computers. None of the mass storage techniques available in the early 1950's was clearly superior; the choice always involved a trade-off of access time versus reliability. This unsettled situation persisted until the end of this period, when the magnetic core memory was perfected.

The drum was by far the most common memory device. A third of the stored-program computers used it for their primary memory, and most of the others used it for secondary storage. The most popular of the early computers, the IBM 650 with several thousand installations, was a drum machine. A drum is fundamentally an electromechanical device; its reliability, high capacity, and relatively low cost made it the most successful medium.

The designers of the first stored-program computers had high hopes for purely electronic, parallel memories. Williams tubes were widely available, but their performance was erratic. Developed in Manchester, England in 1948, they were used on the IBM 701 and in a variant form on the Whirlwind.

John von Neumann, unsatisfied with their reliability, contracted with Jan Rajchman at RCA to produce an electronic, parallel memory, but von Neumann had to make due with Williams tubes on the IAS machine and its offspring in Los Alamos and elsewhere. Finally, Jan Rajchman's Selectron was completed and installed, but worked well on only one machine, the Johnniac at the Rand Corporation.

Some 15 first-generation computers used mercury delay lines for their main memory. The delay line was more reliable but slower than the Williams tube, while it was less reliable but faster than a drum. The UNIVAC's

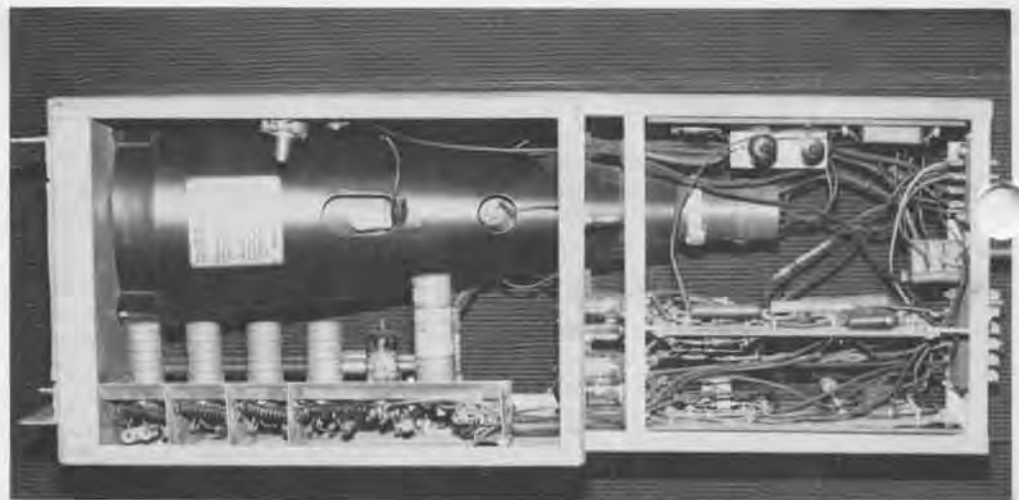

SWAC Williams Tube. *The Williams tube was invented by Sir Frederick Williams at the University of Manchester in 1948. It was the first purely electronic parallel memory, but it was unreliable. Although magnetic-core memories superseded the Williams tube by 1954, the Williams tube was still faster than drum memory and delay lines. Unlike the earlier version of the Williams tube, the Williams tube from the SWAC (Standards Western Automatic Computer) was more compact and featured higher reliability. It enabled the calculator from the SWAC to fully utilize the speed of the Williams tube memory by completing*

arithmetic operations in a few microseconds. Instead of handling numbers as a train of pulses, there were parallel circuits in the SWAC that transferred numbers almost instantly. This transferring of numbers in parallel made it possible to do computations at many times the speed of serial computers. The SWAC was the first Williams tube computer to be completed in the United States. Its rate of success was also dramatic, producing useful results seventy percent of the time. The Williams tube from the SWAC is on exhibit at The Computer Museum.





IBM 650. The IBM 650 was the most widely used first-generation computer. Hundreds were delivered between 1955 and 1959. Although the 650 was faster than other magnetic drum computers, its high success rate was a result of a well-integrated, punched-card input and output and its adaptability to existing punched-card systems.

delay line memory, for example, could access a number in 400 microseconds, compared to 25 microseconds for IAS's Williams tube store, and 2,500 microseconds for the IBM 650 drum. Delay line computers included many historically significant machines: the Cambridge EDSAC, the EDVAC, the SEAC, the Pilot ACE, and the UNIVAC. A few other machines, such as the Pegasus, used magneto-strictive delay lines.

The development of magnetic core memory finally gave computer designers a memory that was reliable, fast and parallel, but expensive at the outset. In 1953, core memories were installed on the Whirlwind computer at MIT and the ENIAC at the Ballistic Research Lab. By 1955, only two commercial computers, the RCA BIZMAC and ERA 1103A, used core memory. Without the new manufacturing technology to build cores, manufacturers of machines based on drums, delay lines, and other devices continued to plan and build these architectures until the price of core fabrication fell.

Harry Huskey, who designed a superior version of the Bendix G15, says: "Bendix made more than four hundred of the G15's—in fact the fittings on number 400 were gold plated. Bendix did plan a transistor version of the G15 but the declining costs of magnetic cores and their improved reliability marked the end of the cyclic memory computers."

Input/Output

Nearly all first-generation computers used a Flexowriter or comparable electronic typewriter with a paper tape reader attached for both input and output. The Flexowriter was simple and rugged, but slow. Photoelectric readers, pioneered on EDSAC and quickly adopted in the United States, read paper tape 20 times faster. A photoelectric reader could input data at 120 characters per second (cps) instead of the six cps that a mechanical reader could handle.

Other computers used punched cards or teletype. The CRT display, so familiar to modern computer users, first appeared on one or two experimental computers like the Whirlwind, and finally on a commercial computer, the ERA 1103, in 1955.

Almost from the beginning of this era, designers recognized the advantages of magnetic tape as a medium for bulk input/output, but tape was slow in being adopted. The use of metallic tape was pioneered on the UNIVAC while the SEAC used magnetic wire mounted in compact cassettes for off-line storage.

Size

The smallest stored-program computer was probably one built by Hughes Aircraft for aircraft guidance and control. It measured about two feet by one foot, used a drum memory, and

Huskey Lecture. Harry Huskey giving a lecture next to his Bendix G15 at The Computer Museum in December 1982. He said: "In 1952 and 1953 while at Wayne University (Detroit), I dusted off the ideas and designed a computer which the Bendix Corporation elected to build, the Bendix G15. The memory was a magnetic drum with separate read and write heads. All information was read, erased and re-written every drum rotation—just like the mercury delay lines. This gave some technical advantages—the read heads and the write heads could each be optimized for their functions."

was installed aboard a C-47 airplane in 1953. The largest was perhaps the Whirlwind, which occupied 55,000 square feet. Other large-scale installations that could claim the honor of "biggest" include the IBM 701, the RCA BIZMAC, and the Harvard Mark II, which filled a large room at the Naval Proving Ground in Dahlgreen, Virginia.

Commercial drum computers were generally quite small, ranging in size from that of a small desk to several large cabinets. The cost of development and construction ranged from a few thousand dollars for a prototype Circle Computer (surely the cheapest) to several million for Whirlwind. However, the Whirlwind was more than a single computer, it was an ongoing project involving computers, memories and applications programming.

Architecture

Quite a few computers without a stored-program design were produced and sold into the 1950's. The advantages of the stored program design were slow in being accepted, and many companies built computers of both types. ERA, for example, built a "Logistics Computer" in 1952, which incorporated a fixed program for certain types of problems.

Computer Research Corporation built a general-purpose drum computer, the CRC 102, and also produced the popular CRC 101, a special-purpose machine called a Digital Differential Analyzer. The aircraft industry, a big customer for digital differential analyzers, kept the market alive and several companies were the suppliers. Several externally-programmed drum computers installed in Continental Europe reflected the design of Howard Aiken's Harvard Mark III and Mark IV.

Of the stored program computers, about an equal mix handled numbers serially, digit by digit, and in parallel, a word at a time. Similarly, they were equally mixed between binary and decimal machines, with some commercial models like the CRC 102 available either as a binary or a decimal machine.

A wide range of instruction sets also existed, from CALDIC with only a dozen or so instructions, to the RAYDAC with a four-address code and built-in fixed and floating point instructions. When random access core memory re-

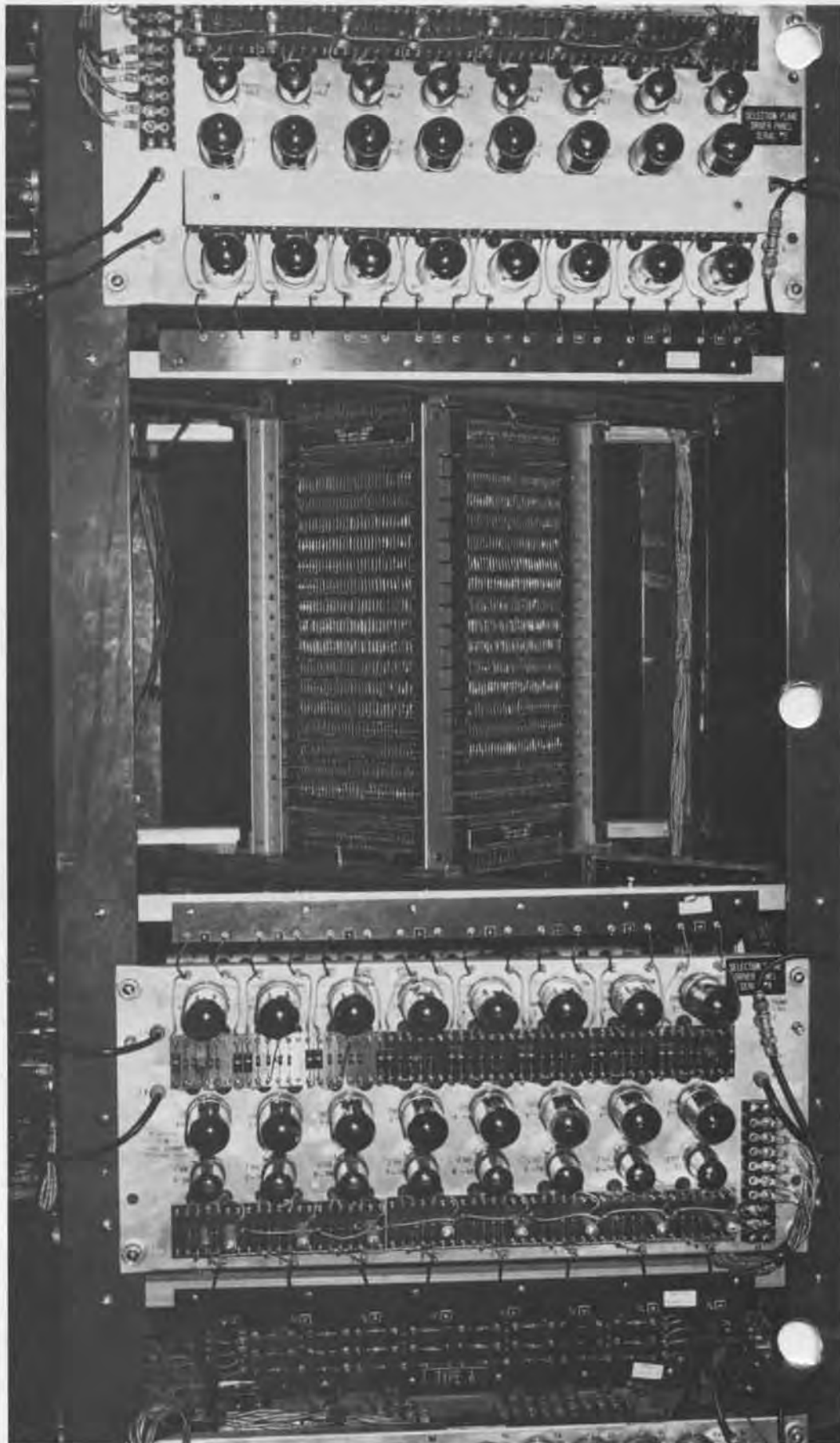

placed serially-accessed magnetic drums or delay lines, the "von Neumann" architecture of binary arithmetic, single-address instructions, and parallel memory prevailed.

Reports by Burks, Goldstine, and von Neumann on the IAS computer discussed the stored-program principle in detail, especially with regard to modifying the address field of an instruction during a program's execution. Several first-generation computers used special index registers to accomplish the same thing. These were called "B-lines" on the Ferranti Mark I, the first machine to use them, and the name stuck. In the United States, the Consolidated Engineering 30-201 and its descendants had B-lines. Descriptions of computer architectures nearly always mentioned the stored program in connection with indexing. Some descriptions, including one by Alan Perlis, point out that computers with B-lines were superior in many ways to the simpler IAS design.

Programming

The first generation of computers were programmed in machine language, typically by binary digits punched into a paper tape. Activity in higher-level programming was found on both the large-scale machine and on the smaller commercial drum computers.

High-level programming languages have their roots in the mundane. A pressing problem for users of drum computers was placing the program and data on the drum in a way that minimized the waiting time for the computer to fetch them.

It did not take long to realize that the computer could perform the necessary calculations to minimize the so called latency, and out of these routines grew the first rudimentary compilers and interpreters. Indeed, nearly every drum or delay line computer had at least one optimizing compiler. Some of the routines among the serial memory computers include SOAP for the IBM 650, IT for the Data-tron, and Magic for the University of Michigan's MIDAC.

Parallel memory machines had less sophisticated and diverse compilers and interpreters. Among the exceptions were SPEEDCODE developed for the IBM 701, JOSS for the Johnniac, and

a number of compilers and interpreters for the Whirlwind.

Use

The list of computing installations up to 1955 reveals dominance of the military, followed by laboratory and then business use. In 1954, a Magnefile was installed for inventory control at B. Altman & Co. in New York, and a MODAC 404 was used by *Reader's Digest* for keeping track of subscriptions, but these were exceptions to the rule.

Installations found at air force or army bases often had not just one, but several computers. Though not a "typical" installation, the Ballistic Research Lab at Aberdeen, Maryland illustrates how military agencies commanded the greater fraction of all computing power in the mid-1950's. It included: ENIAC; a Bell Labs Model V Relay Computer; EDVAC (a stored-program, serial computer); ORDVAC (a stored-program, parallel computer); several digital differential analyzers; punched card multipliers; analog computers; desk calculators, and other computing devices of various shapes and sizes.

Conclusion

The "milestones" of the first generation were brought about by many people who continue to be leaders in the field. Grace Hopper worked on the UNIVAC; Maurice Wilkes on the EDSAC; Joe Weizenbaum and Harry Huskey on the Bendix G-15; Gene Amdahl on his dissertation machine, the WISC; Max Palevsky on the Bendix D-12 Digital Differential Analyzer; An Wang on the Wedilog; Ken Olsen on MIT's memory test computer; and Seymour Cray on the ERA 1103.

Computing was about to change rapidly. In the next few years installations jumped to the thousands. Serially-produced, commercially-manufactured, standardized machines became the rule. Over the years, experimentation has continued, but never with the diversity of ideas about the basic architecture of this inaugural era.

Paul Ceruzzi, with Rod McDonald and Gregory Welch.

Core Memory Stack. This core memory stack from the Whirlwind, which is on exhibit at The Computer Museum, measures 17 x 10 x 9 inches. Each core memory plane is arranged in an array of 32 x 32 cores. The first core memories were designed by Jay Forrester for the Whirlwind in 1953 at MIT. Computer access time dropped from twenty-five microseconds for tube storage to nine microseconds for magnetic cores.

The Core Process: How Ferrite Cores Were Made

A manufacturing process for core memories was developed by Lincoln Labs in 1952. Core memories were always strung by hand, and production of the first cores was complex and expensive. The following picture story is from the unclassified manual, **Ferrite Cores For Computer Memories**. These cores were used in the Whirlwind and the Memory Test Computer.



Core Pressing. After five days of getting the material ready for making cores, core pressing was done automatically by a Stokes press which was capable of 60 pressing operations per minute.



Dimensional Check. The machine die and the weight of the pressed cores had to be continually monitored to insure maximum uniformity of core size. Before each press run a dimensional check was made with a tool-maker's microscope in order to assure quality control.

Cooling. After the cores left the tunnel of the kiln, they were still at an elevated temperature of 500 F. Cooling took place quickly in the open air, and then the cores were ready for counting and electrical testing.

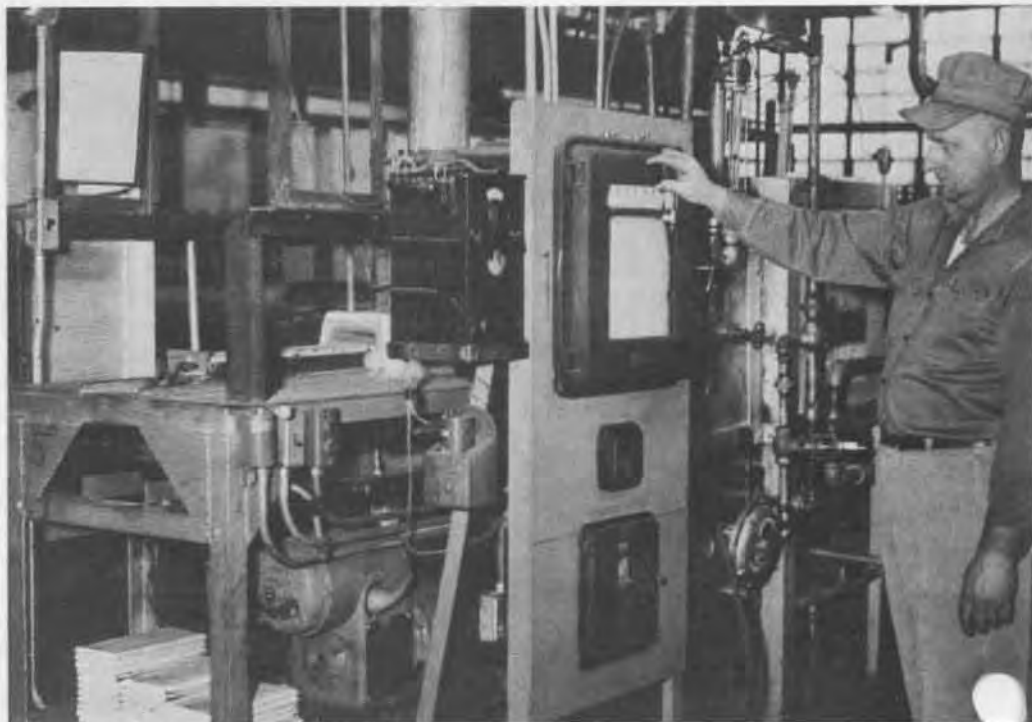

Firing. Firing was the most critical operation of core production. The firing temperature was approximately

2400 F, and elaborate controls were necessary to maintain the correct temperature.

For Computer Memories

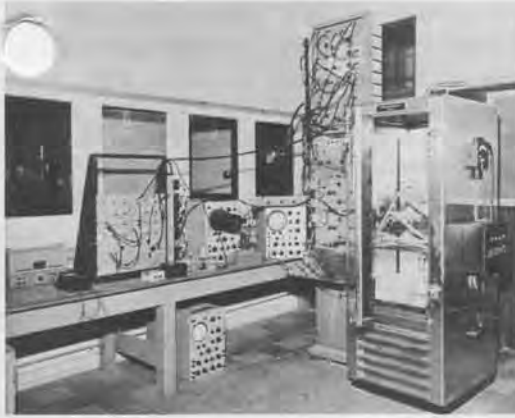

Electrical Testing. Core drivers helped in electrical core testing. The cores, which were temperature sensitive, were tested at a uniform 25 C. The temperature was controlled by core handlers in temperature-regulated boxes or air-conditioned rooms.

Evaluation Test. Evaluation pulse testing was performed on a sample of 20 cores. The data obtained from the hysteresis-loop tests and the evaluation pulse tests yielded important information concerning the performance of core lots in a memory. It was at this step where lots could be rejected on the basis of the evaluation test.



Stringing. After core testing had been completed, the magnetic cores which had been accepted were hand strung into memory planes of 4096 cores each.

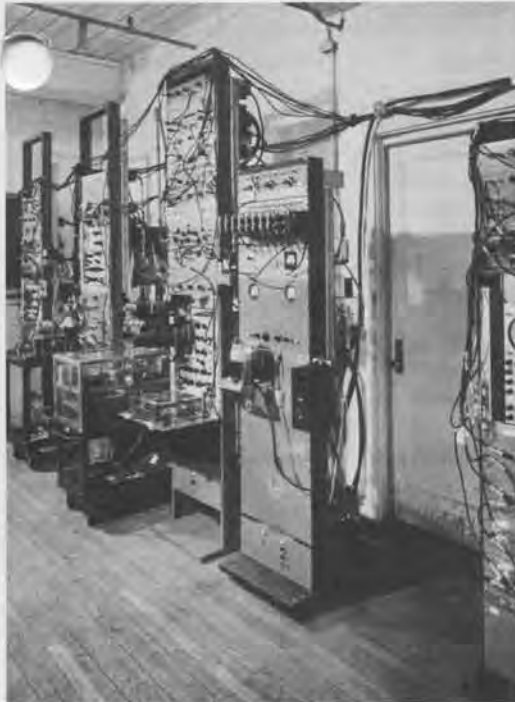

Pulse Testing. A sample of 50 cores from each lot was used for hysteresis-loop measurements. The test equipment for pulse testing and semiautomatic selection testing consisted of an electronic core counter, an evaluation pulse tester, fully automatic and semiautomatic core testers, and a plane tester.



Final Test. The cores in the plane were then given a final pulse-response test in order insure their acceptability. If damaged, removal of defective cores from a plane was easy at this stage.

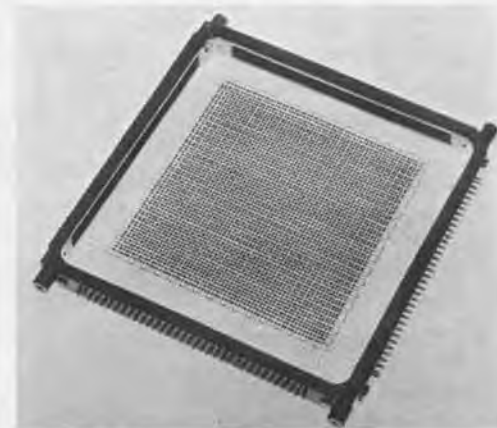

Finished Product. The final operation in the construction of a plane was the insertion of the inhibit winding and sensing wire which linked all the cores in the plane.

The Evolution of Software

The following excerpts are from a lecture presented at The Computer Museum on September 22, 1983.

The Engineer

He golfs, lectures and writes. He also creates objects, industries, employs, creates choice, has confrontations with nature, capitalizes, invests, manufactures, and markets. Some become wealthy and institutionalize themselves, while others become critics, they then repent, reinvent man, immortalize, and warn us of problems.

Software

The definition of software is: That which is in the computer and is not hard. The use is not pejorative, but is indicative of plasticity and tendency of change. Some say that software is made up of algorithms, systems, packages, modules, etc. Organithm is another word that could be used to describe software, if one wished to concentrate on its evolutionary and dynamic aspects. Each of these words accent an aspect of software. It is we who have created an enormous number of algorithms. Systems are collec-

tions of programs that cooperate to carry out a number of related activities. They have boundaries and inflate, collapse, and reinflate.

Packages accent portability to other machines and places, and sharp boundaries. They also reform specific jobs.

Organithms, dynamic collections of algorithms, modules, etc., evolve, give birth, and perish. They have no inherent stability or solid shape. They flourish in the machine because they exercise the mind.

All these words are found in literature and the press. They accent different aspects of software.

The Computer, Determining Factor

As computers become smaller and more reliable, the problem arises of making software smaller. The only things which we can easily build that work reliably are things which we have already built. One major problem we encounter is that we cannot guarantee to build software which works the first time.

The physical computer and applications drive software. Science and engineering were the source of the first applications. Hence, the first programming languages were designed to fit scientific and engineering calculations.

When seeking the unattainable, simplicity only gets in the way (that is for people who write government contracts).

Everything we do in nature may end up being modeled on the computer, which means that we must find programs that do the things we think about.

Important factors are the people who are doing the computing, who ought to be doing it, and who will be doing it in the future.

In the mind of the programmer, software is a mirror of what a collective mind wishes to think about and process. Computers will fail us in the most critical way, unless almost everything in our mind can be captured in programming, and hence in executable programs. We must keep in mind that whereas the arts interpret our dreams, computers execute them,

Technology and the engineer

We observe

We identify a gap, a mismatch, a bottleneck
a misuse, a non-use

We model -

We test

We create an object, an industry, a state of mind

We employ, create choice, improve control
reduce confrontation with nature

We capitalize and invest

We manufacture

We market

We advertise

We become wealthy

We institutionalize

We extol

We endorse

We golf

We repent, criticize,
re-invent "man",

normalize

re-order priorities

warn

We lecture and write

thereby changing the boundaries of our dream worlds, irrevocably.

Perfection in synthesis, software included, defines monuments, but is an encumbrance in tools. APL is an example of such a synthesis. It was designed, not by a committee, but by one person, which is a rarity in programming languages. Not only was it designed by one person, but it also resisted evolution because of its initial perfection. The only thing APL compares favorably to is the statue of Moses in Rome by Michaelangelo. It has few rough edges and is made out of stone. Perfection has no need for change and growth. For languages and software this is the kiss of death.

You can not pass from the informal to the formal by formal means.

Two Issues Which Govern Software: Function and the Way Things Will Fit

The concept of the procedure or function is a driving force behind software organization. After you write two programs you begin to worry about how they fit together. A great deal of design time is spent on making things fit together well.

Binding time is another important factor: When do things become constant and more concrete? It is software that gives us choices in variable binding time where hardware does not.

Driving Forces of Software

Communication is a major factor in computation. We partition tasks and save the results of computation to the degree that communication is available. It is networks that will have the next revolutionary effect on software. A current concern is computer mail over a network. Who is going to process the mail? Only another program can read and process mail when the networks get large. Human beings will drift away from the interfacing with networks and more things will be done by surrogate humans (programs).

Evolution tells us that everything we build is wrong, or, at best, temporary. Thus, the main purpose of software tools is to improve the rate at which we can evolve software. Software, like life itself, is subject to evolution.

The Major Tension in Software is Commerce vs Perception

Commerce enables programs to create traffic on computers, and we must get to know what keeps it bound. Yet with perception, every program we write impels us to realize that we should have written something else. Since commerce and perception dominates software, when you write a successful program you want to get it used.

As soon as a program gets large, consequences arise. It becomes so large that people have difficulty changing it from one purpose to another nearby, or grasping its potential.

Effects of dispersion are important because you automatically are beholden to a large anonymous population. Then processing complaints has an enormous cost of dispersion.

Pascal owes its importance to the minicomputer and the microcomputer.

What is software? ①

① That which is in the computer and is not hard

② Algorithms

③ Systems

④ Packages

⑤ Organizations

For man, immortality can only be achieved posthumously.

Concerning the past proceduring of software, only when you have executed a system can you determine what the real procedures are.

What is the role of language? Languages are important because they shape the way we think and communicate to human and machine.

If you teach people BASIC first, they will be crippled when they attempt to master APL. We appreciate how narrow our computer languages are, but do not know how to expand them graciously. It is not that we are reinventing the wheel, but that we do not know how to invent wheels of every appropriate size.

Size of Machines

Tools, automatic programming and cooperation are essential to the reduction of machine size. But it is important for us to also create large machines of low efficiency and high

Museum Receives University of Illinois Collection

utility because we need systems for understanding natural languages, processing vision, etc. It is their imperfections which will spark the work that will lead to better, more useful, and more economical systems.

In programming, the search for brevity is the search for survival.

What is The Measure for Success?

The ratio of how little we can put into a machine to how much we can get out of it measures success. Put another way, the cost of the future is the delay in utilizing the past.

Alan J. Perlis

Eugene Higgins Professor of Computer Science, Yale University



A collection of computing components and calculating instruments from the University of Illinois was recently given to The Computer Museum. This collection includes significant components from ILLIACs I, II, and III, as well as calculating and drawing instruments from the university's Department of Mathematics and Engineering. Included was a motorized Millionaire calculator with a keyboard which completes the Museum's collection on the evolution of this instrument.

Museum board member Gordon Bell, who gave a series of lectures at the University of Illinois, formally accepted the collection for the Museum. The collection was delivered to the Museum's new location at Museum Wharf in downtown Boston and will be integrated into new exhibits.

University of Illinois Collection. Professor James N. Snyder, head of the Computer Science Department at the University of Illinois, hands Gordon Bell a sense amplifier from the ILLIAC II while Daniel C. Drucker, dean of engineering, looks on.

貴方のコンピュータが
英語を話すなら
多分日本製である

"If your computer speaks English,
it was probably made in Japan."

Alan J. Perlis

UNISERVO. A typographical error in the last Report led to the renaming of Uniservo, the tape handler for Univac's plated thin film metal recording tape. Its correct name is Uniservo not "Universo" as printed on page 13 of the Fall Report.

Kurzweil Reading Machine Speaks at Bits and Bites Presentation

"It sounds like an Irishman with a Mexican accent," says one listener. No, I think it sounds like a German version of Speak and Spell," argues another onlooker.

Oblivious to the spectators, the reader continues: "Oh say can you see by the dawn's early light, what bright stars and . . ."

The Kurzweil Reading Machine recited the "Star Spangled Banner" to a rapt audience of thirty at the first talk of the fall "Bits and Bites" series on September 18th.

Sounding out the words phonetically, the Kurzweil machine also read the poster promoting itself. "The greatest thing since Braille." The Kurzweil Reading Machine reads printed material aloud.

Assisting the machine in the demonstration were Gail Yarnell and Randy Stern of Kurzweil Computer Products.

The Kurzweil Reading Machine reads everything from newspapers to books and original manuscripts. Designed in 1974 by Raymond Kurzweil, the machine uses an electronic scanner with a speech synthesizer to read printed material aloud.

It can read 200 different typefaces at up to 255 words-per-minute. The machine is programmed for one thousand linguistic rules and two thousand exceptions.

Both its cost and size have dropped dramatically since its introduction. Initially it filled half a room



Explaining. Gail Yarnell describes how the Kurzweil Reading Machine works to a visitor at the Bits and Bites fall gallery talk about the new machine.



and could only read print typed on Kurzweil's personal typewriter. Today, it comes as a desk-top model and costs \$29,000 (\$20,000 less than its original price in 1974).

Hundreds of libraries and universities throughout the country now have Kurzweil Reading Machines, and a number of blind people also have them in their offices.

Currently, the machines only read English, but the company is working on programs to have it read several European languages.

The early Kurzweil machine with its Nova 3 interior on exhibit at The Computer Museum was a gift of Kurzweil Computer Products, a division of Xerox Corporation. More advanced versions speak without a "foreign accent."

Kurzweil Machine Reads. An attentive audience listens to the Kurzweil Reading Machine read aloud at a fall Bits and Bites presentation. Standing by the machine is Gail Yarnell of Kurzweil Computer Products, who demonstrated the unique device.

Bits and Bites on Multiwire



Joe Hammond. Hammond, vice president, Discrete Wiring Technology, PCK Technology Division, Kollmorgen Corporation, explains the evolution, development and use of the Multiwire Wiring Machine, on view in the Third Generation Gallery at The Computer Museum. Ken Fisher, board member of Kollmorgen, and his wife, Barbara, are sitting just in front of the machine. Hammond's presentation on September 18th was the second of eight fall Bits and Bites gallery talks.



Members Visit Museum Wharf

On Sunday, September 11th, with record breaking temperatures of over 95 degrees in downtown Boston, about 100 members explored our new empty, but cool place. While the space is bare

of any furnishings, it has all the basics: a heat pump for each of the major galleries, sprinkler systems, proper emergency fire stairs, and facilities to meet the needs of the handicapped.

Scenic View. A slow elevator ride from the ground floor up to The Computer Museum's space on floors five and six gave visiting members a chance to see Fort Point Channel, the Tea Party Ship and downtown Boston.



Wharf Interior. Greg Welch, from the Museum exhibits department, shows a group of members through the new environment. Red tape and chalk on the floor indicate divider walls and exhibit areas respectively. Members touring the facilities had to rely on their memories and imaginations to visualize the new exhibits.



Yard Sale

On Sunday October 2nd, The Computer Museum held its first cash and carry indoor yard sale to sell duplicate items from the Museum's collection. With the help of many volunteers, the sale was a success as well as a day of hard work for those involved.

After the first hour, it became clear that the buyers did not want the big old machines, just their parts. Members, Don Gaubatz, Bill Ricker, Ian MacLennan, Dave Koogler, Armando Stettner, and Dick Rubinstein, along with the staff went to work with screwdrivers and pliers and took everything apart. Every core memory stack that could be salvaged was sold; along with every old name plate and console panel.

It was the hackers version of "Let's make a Deal." Members set prices and made deals all day. Susan Kaelin, the cashier, sold more than a thousand dollars worth of bits and pieces and one whole PDP-8.

A number of children came with their parents and went off with piles of components: clearly the next engineers tinkering at home—perhaps to the consternation of a parent—but also getting a feeling for the technology.

The yard sale brought the staff and some members closer together. At the suggestion of the participants, the Museum now plans to have some work parties in order to prepare for the move to Boston.

Checking It Out



Rummaging

Making a Sale



Membership Coupon

Join the Museum or Give a Gift Membership

Membership

Name _____

Address _____

City/Town _____

State _____

Zip _____

Gift Membership

Name _____

Address _____

City/Town _____

State _____

Zip _____

Enclose card from: _____

Please enter a membership in the following category:

- Member \$25
- Founder \$250
- Corporate Founder \$2500

All members receive the quarterly Museum Report, a 10% discount on Museum Store purchases, and announcements of Museum programs and events. All membership contributions are tax-deductible within the limits provided by law.

To become a Member or Founder fill out this coupon and return it with your check or money order to:

Membership Coordinator
The Computer Museum
One Iron Way
Marlboro, Massachusetts 01752

Order Form

The Computer Museum has added integrated circuits to its Slide Collection. The slides are from the Museum's 1984 Computer Era Calendar. The calendar and the slides are available now.

To order the calendar or slides from the collection return this coupon with a check or money order to:

The Computer Museum Store
One Iron Way
Marlboro, Massachusetts
01752

- | | | |
|--------------------------|----------------------------|--------------|
| <input type="checkbox"/> | 1984 Computer Era Calendar | \$ 6.95 |
| <input type="checkbox"/> | Set 9 | \$10.00 |
| <input type="checkbox"/> | Set 1-8 | \$25.00 |
| <input type="checkbox"/> | Set 1 | \$ 3.50 |
| <input type="checkbox"/> | Set 2 | \$ 3.50 |
| <input type="checkbox"/> | Set 3 | \$ 3.50 |
| <input type="checkbox"/> | Set 4 | \$ 3.50 |
| <input type="checkbox"/> | Set 5 | \$ 3.50 |
| <input type="checkbox"/> | Set 6 | \$ 3.50 |
| <input type="checkbox"/> | Set 7 | \$ 3.50 |
| <input type="checkbox"/> | Set 8 | \$ 3.50 |
| <input type="checkbox"/> | Singles | \$ 2.00 each |

Subtotal _____
Add 5% Sales Tax if Mass. resident _____

Add Shipping cost of **\$1.50** _____

TOTAL _____

Name: _____

Address: _____

Tel: _____

Date: _____

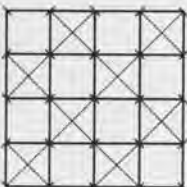

Museum Slides and 1984 Computer Era Calendar

- Set 1: Information Processing History Graphs and Charts**
- 1.1 Theory of Computer Generations.
 - 1.2 Tree of Computer Evolution from 1950 to the 1980's.
 - 1.3 The Pioneer Computers: Memory Size versus Computation Speed.
 - 1.4 Speed of Calculations versus Generation for Manual through ULSI Technology.

- Set 2: Early Calculating Devices**
- 2.1 Napier's Bones: 17th Century Mechanical Aid to Multiplication.
 - 2.2 Pascaline: Mechanical Adding Machine invented by Blaise Pascal (1645).
 - 2.3 Thomas Arithmometer: First Four-Function Practical Mechanical Calculator (1820).
 - 2.4 Thacher's Cylindrical Slide Rule: Achieved the Equivalence of a Sixty Foot Slide Rule (1881).

- Set 3: Hollerith's Tabulator and Sorter for the 1890 U.S. Census**
- 3.1 The Computer Museum's Exhibit of Herman Hollerith's Tabulating and Sorting Machine.
 - 3.2 Pantograph: Manual Device used to Punch Blank Census Cards.
 - 3.3 Punched Card Reader.
 - 3.4 Punched Card Sorter.

- Set 4: MIT's Whirlwind Computer (1945-1953)**
- 4.1 16K Core Memory Stack, Fixed Head Drum and Roomsized Console.
 - 4.2 Fixed Head Drum for Secondary Memory.
 - 4.3 A few of Whirlwind's 5000 Vacuum Tubes.
 - 4.4 Arithmetic Elements of the 32-foot Long, 16-Bit Word.

- Set 5: Early Computers**
- 5.1 SAGE: AN/FSQ-7 Vacuum Tube Computer for Air Defense (1957).
 - 5.2 TX-0: MIT's Full-scale, Transistorized Computer (1956).
 - 5.3 PDP-1: Second Generation Computer, First Video Game "Space War" (1960).
 - 5.4 PDP-8: First Mini-Computer (1965).

- Set 6: Super Computers**
- 6.1 IBM 7030: "Stretch" Console (1961).
 - 6.2 CDC 6600: Console and Processing Cabinet, designed by Seymour Cray (1964).
 - 6.3 Texas Instrument's ASC (Advanced Scientific Computer): Chassis Harness Interconnect of a Processing Unit (1971).
 - 6.4 Burrough's ILLIAC IV: Burroughs Disk, Processing Cabinet and Processing Element with Fairchild Semiconductor Memory (1975).

- Set 7: Logic Technology**
- 7.1 Vacuum Tubes and British Valve from the Mark I circa 1950.
 - 7.2 Transistor Circuitry Modules from a PDP-8 circa 1965.
 - 7.3 Integrated Circuit Board from a PDP-11 circa 1972.
 - 7.4 Micro-processor: Computer on a Silicon Chip circa 1976.

- Set 8: Memory Technology**
- 8.1 William's Tube: Cathode Ray Tube for Primary Memory circa 1948.
 - 8.2 Core Memory Plane circa 1958.
 - 8.3 Fixed Head Drum from English Electric's DEUCE circa 1957.
 - 8.4 Hard Magnetic Disk from the "Stretch" circa 1961.

- Set 9: Integrated Circuits (Full-color slides from the 1984 Computer Era Calendar, chronicling the history of integrated circuits.)**
- 9.1 The first transistor, assembled at Bell Laboratories.
 - 9.2 The first integrated circuits from Texas Instruments.
 - 9.3 A diffusion furnace from National Semiconductor.
 - 9.4 Silicon wafers from Mitel illustrating their fine translucent quality.
 - 9.5 Processed silicon wafers from Inmos after they are packaged.
 - 9.6 The Harris Semiconductor programmable read-only memory, shown during wafer probe test.
 - 9.7 A Ferranti gate array.
 - 9.8 A color raster workstation from CGX used to design very large scale integrated circuits.
 - 9.9 A 16-bit monolithic computing system from Zilog.
 - 9.10 A Photomicrograph illustrating bit-slice technology from Advanced Micro Devices.
 - 9.11 IBM's largest capacity experimental memory chip, a 288K integrated circuit.
 - 9.12 A contemporary data processing chip from Bell Laboratories.

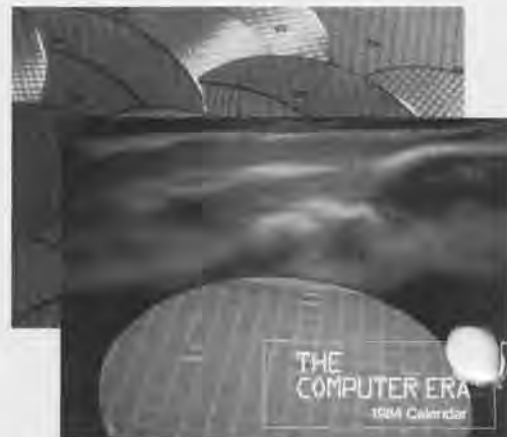

1984 Computer Era Calendar

The Founders Program

Corporate Founders

American Federation of Information
Processing Societies, Inc.
Apollo Computer, Inc.
Association for Computing
Machinery
Automatic Data Processing, Inc.
Benton and Bowles
Bolt, Beranek and Newman
Boris Color Labs
British Computer Society
Robert Cipriani Associates
Clint Clemens
Codennoll Technology Corporation
Computer Science Press
ComputerWorld
Control Data Corporation
Convergent Technologies
Coopers and Lybrand, Boston
Data General
Dataproducts Corporation
Digital Equipment Corporation
Digital Equipment Computer
Users Society
Ford Motor Company
Fujitsu Limited
General Systems Group, Inc.
Hewlett Packard Company
Foundation
IEEE Computer Society
Intel Corporation
International Telephone and
Telegraph Corporation
MDB Systems, Incorporated
MITRE Corporation
Motorola, Incorporated
OMNI Publications International, Ltd.
Richard Reno
Schlumberger Foundation
Seldin Publishing
Software Results Corporation
Tobin Vending Service
The Travelers
Wang Laboratories

New Individual Founders

David R. Block
R. S. Chehey1
Peter Freeman
Henry Fuchs
Steve Golson
Stephen Gross
Richard Hill
Michael Jenabek
John W. Lacey
Robert Laman
Jonie LaBombard & Bill Noyce
Bert W. Larey
Duncan Lawrie
Steven Lipner
Andrew H. Mason
L. Mazzucchelli
F. Warren McFarlan
George McQuilken
Joseph Nestor
Paul Pangaro
John Peterson
Michael D. Poe
Donald Spencer
Frederic G. Withington

THE END BIT

0000000000000001

A newsbrief of the collection

The Computer Museum has a new found friend named Shakey. Developed in 1969 by the Stanford Research Institute, Shakey was the first fully-mobile robot with artificial intelligence. He was not named until fully operational, and then named himself by his "shakey" actions. Shakey is seven feet tall with his antenna, has a TV camera, and touch and distance sensors. Shakey will be on exhibit in our new home at Museum Wharf.

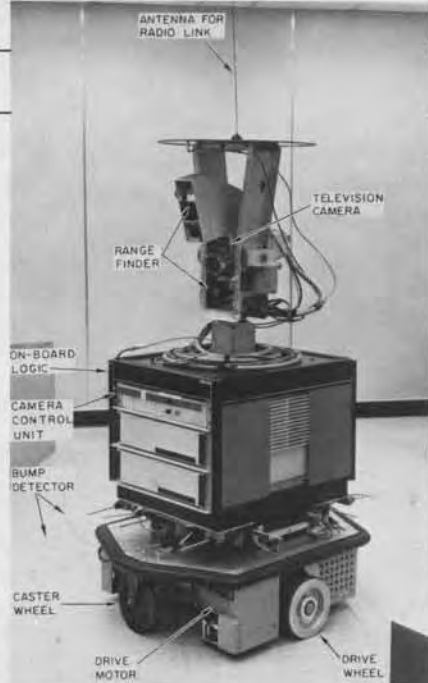

The Computer Museum

One Iron Way
Marlboro,
Massachusetts
01752

Non-Profit
Organization
U.S. Postage
PAID
Permit No. 110
Fitchburg, MA
01420

THE COMPUTER MUSEUM HISTORY CENTER



1 026 2146 7

The first three stages in the life of the TX-0 computer: Designed at Lincoln Laboratory in 1955. Moved to MIT in July, 1958. Running again at The Computer Museum, November 13, 1983.

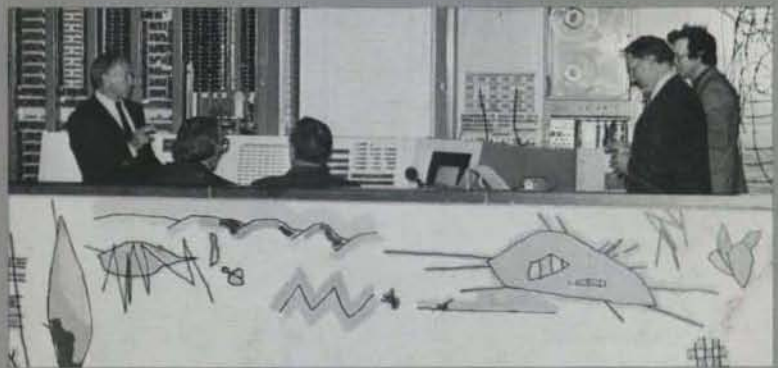

Contents

- 1** Director's Letter
- 2** The TX-0: Its Past and Present
John Allen
Gordon Bell
Jack Dennis
Jack Gilmore
Shag Graetz
Dave Gross
Alan Kotok
John McKenzie
Harrison (Dit) Morse
Phil Peterson
Doug Ross
Stan Shultz
John Ward
- 12** Card Computing at Burndy Corporation
Gregory W. Welch
- 14** Inside Stories on Computer History Told at Fall Programs
- 15** Robert Noyce to Speak at Museum May 11th
- 16** The Members' Association and the Move to Boston
Museum Takes Computer History to Audiences Nationwide
- 17** Founders
The End Bit
A news brief of the collection

Photo Credits:

- Gwen Bell p. 7
CBS, *The Thinking Machine* p. 5
The MIT Museum pp. 4, 5, (cover)
The Science Museum, London p. 1
Chris Spock (back cover)
Meredith Stelling p. 16
Phil Rosen pp. 4, 5, 6, 7, 8, 9, 10, 11, 14, 15
Gregory W. Welch pp. 12, 13

THE COMPUTER MUSEUM

The Computer Museum is a non-profit, public, charitable foundation dedicated to preserving and exhibiting an industry-wide, broad-based collection of the history of information processing. Computer history is interpreted through exhibits, publications, videotapes, lectures, educational programs, and other programs. The Museum archives both artifacts and documentation and makes the materials available for scholarly use.

Museum membership is available to individuals and non-profit organizations for \$25 annually and to businesses for \$125 annually. Members receive the quarterly Report, invitations to all lectures and special programs, new posters, and a ten percent discount in the Museum store.

A Founders program is in effect during the initial two-year period of the Museum, until June 10, 1984. During this period individuals and non-profit organizations may become Founders for \$250 and businesses and charitable Foundations may become Founders for \$2500. Founders receive all benefits of membership and recognition for their important role in establishing the Museum.

The Computer Museum is temporarily closed in preparation for its move to Boston. It will reopen at Museum Wharf in downtown Boston in fall 1984. For more information, call (617) 426-2800.

THE COMPUTER MUSEUM REPORT (ISSN 0736-5438)

The Computer Museum Report is published quarterly by The Computer Museum, 300 Congress Street, Boston, MA 02210. Annual subscription is part of the membership of the Museum (\$25 per year for individuals and nonprofit organizations and \$125 for corporations).

The purpose is to report on the programs and exhibitions of the Museum. The contents of The Computer Museum Report may not be reproduced without written consent.

The Museum Staff is responsible for the contents of the Report. The opinions expressed do not necessarily represent those of The Computer Museum or its Board of Directors.

The design and production of the Report is done by Benson and Clemons.

STAFF

Director
Gwen Bell

Administration
Geri Rodgers, Coordinator

Communications
Stephanie Haack, Coordinator
Brenda Erie

Exhibits and Archives
Meredith Stelling, Coordinator
Oliver B. R. Strimpel, Visiting Curator
Beth Parkhurst, Research Fellow
Paul Ceruzzi, Research Associate
Wendy Blakeman; John McKenzie;
Gregory Welch; Bill Wisheart.

Programs and Membership
Christine Rudomin, Coordinator

Store
Carole Strecker, Coordinator

The Computer Museum
300 Congress Street
Boston, Massachusetts 02210
(617) 426-2800

BOARD OF DIRECTORS

Kenneth H. Olsen, Chairman
Digital Equipment Corporation

Charles W. Bachman, Chairman, Executive Committee
Bachman Information Systems

C. Gordon Bell
Encore Computer Corporation

Gwen Bell
The Computer Museum

Erich Bloch
International Business Machines

Harvey D. Cragon
Texas Instruments

David Donaldson
Ropes and Grey

Robert Everett
The MITRE Corporation

Sydney Fernbach
Computer Consultant

C. Lester Hogan
Fairchild Camera and Instrument Corporation

Theodore G. Johnson
Digital Equipment Corporation

Andrew C. Knowles III
Lexidata Corporation

John Lacey
Control Data Corporation

Pat McGovern
ComputerWorld

James McKenney
Harvard Business School

George Michael
Lawrence Livermore Laboratories

Robert N. Noyce
Intel

Brian Randell
University of Newcastle-upon-Tyne

Jean E. Sammet
International Business Machines

Edward A. Schwartz
Digital Equipment Corporation

Kitty Selfridge, Chairman, Members Committee
Henco Software, Inc.

Michael Spock
The Children's Museum of Boston

Erwin Tomash
Dataproducts

Honorable Paul E. Tsongas
U.S. Senator, Massachusetts

The Director's Letter

I'm often asked, "Will there be a lot of interactive exhibits in The Computer Museum?"

I don't have a short answer. The long answer compares two exhibits: the TX-0, the first transistorized computer, one of the first computers used for interactive graphics, and a planned exhibition called "The Computer and the Image."

Seeing the TX-0 exhibit—with its banks of switches, bulky Flexowriter, rows of toggle switches, wall of supplies, with its heavy steel chairs with peeling vinyl covers, tile floor and venetian blinds—sends the viewer back to the late fifties. And on days that John McKenzie, with his dapper bow tie, set of tools and complete machine log, is busily maintaining the machine, the visitor has the extra advantage of a demonstration or discussion of the machine's state. One of its demonstration programs of a mouse learning its way to cheese (or a martini) has been a favorite for 25 years—even though its graphics don't measure up to those on a handheld child's toy. For many, this seems to be involving enough, although not really "interactive."

To take the next step, to make the TX-0 operable by the visitor, is to put the clock back: the machine fills a room, yet is less powerful than many programmable calculators, takes a half-hour to start and demands programming in its assembly language MACRO. This is an investment in time that most museum-goers don't make. But what about the rare person who feels that they must program the TX-0? For them, the machine is to be simulated on the Museum's VAX. Dan Klein from the Mellon Institute has put a number of the instruction sets for the classic machines, including the TX-0, on the VAX. The serious visitor can then have easy access to classic machines at a terminal in the new library of the Museum.

Another way to experience the TX-0 in action is truly vicarious: watching a 1961 made-for-television film about the machine, how it was used, with demonstrations of many of the programs. Such classic films will be used with many of the exhibits on super computers and vacuum tube machines that took in the order of 100,000 watts to turn on. Even if we got one of these machines together, the Museum could never afford to run it. Nor does it make any sense when the same computing power is available on a machine that requires a hundredth of the electrical power. To experience the size and power decline of the machines through the generations brings home the point better than any textbook statement.

Historic machines will only be one dimension of The Computer Museum when it moves to Boston. Several exhibition areas will emphasize contemporary computing with interactive exhibits that demystify the "black box." The first of these is "The Computer and the Image Gallery" now being planned by Oliver Strimpel, on leave from The Science Museum, London. The aim of the exhibition is to convey the full breadth of computer imaging, from computer-aided design to the simulation of galaxy evolution, from Landsat image-processing to computer-drawn animation.

In explaining the concepts of computer graphics, interactive displays will be used. What better way to understand how resolution affects a picture than to alter the resolution yourself? Or stretch the contrast, or distort the image with a simple mathematical function?

Computer graphics can also portray objects that do not exist in real life. Interaction allows the visitor to walk around them or zoom in on areas of interest. Simulations using computer graphics often rely on the choice of parameters by the user, who gets more involved by entering his own choice.

The focus of The Computer Museum is not to create "interactive" exhibits, but to preserve and explain the scientific and technological history of computing in the most appropriate and exciting way that it can be done.

Gwen Bell



Oliver B. R. Strimpel

The TX-0: Its Past and Present

Up and Running. For the third time in its history the TX-0 was fully operational, this time at The Computer Museum. It was built at Lincoln Laboratory in 1955 as an experimental computer to test transistors, and had its first birth in 1956. Then in 1958 it was dismantled and reborn at Massachusetts Institute of Technology (MIT) where it operated until the mid-sixties.

The TX-0 fills a room, yet has less memory than many personal computers. And unlike today's personal computers, the TX-0 demands a skilled user to maintain full-scale operation.

The machine is a good example of what computing was really like 20 years ago.

Jack Dennis and John McKenzie were responsible for the TX-0 at MIT before its shutdown. This time around McKenzie was the operations manager and the first to witness it come back to life. He worked for months preparing the classic, 1955 computer for its debut at The Computer Museum.

His efforts paid off when TX-0 alumni, Museum members and other computer buffs united on Sunday, November 13th, to display their enthusi-

asm for keeping the artifact in working order. For one day, those who had been vital to the development and day-to-day operations of the TX-0 reminisced about the days when it was at the apex of computer technology.

A series of events were held touching on all phases of the TX-0's past. The day's events were videotaped for the

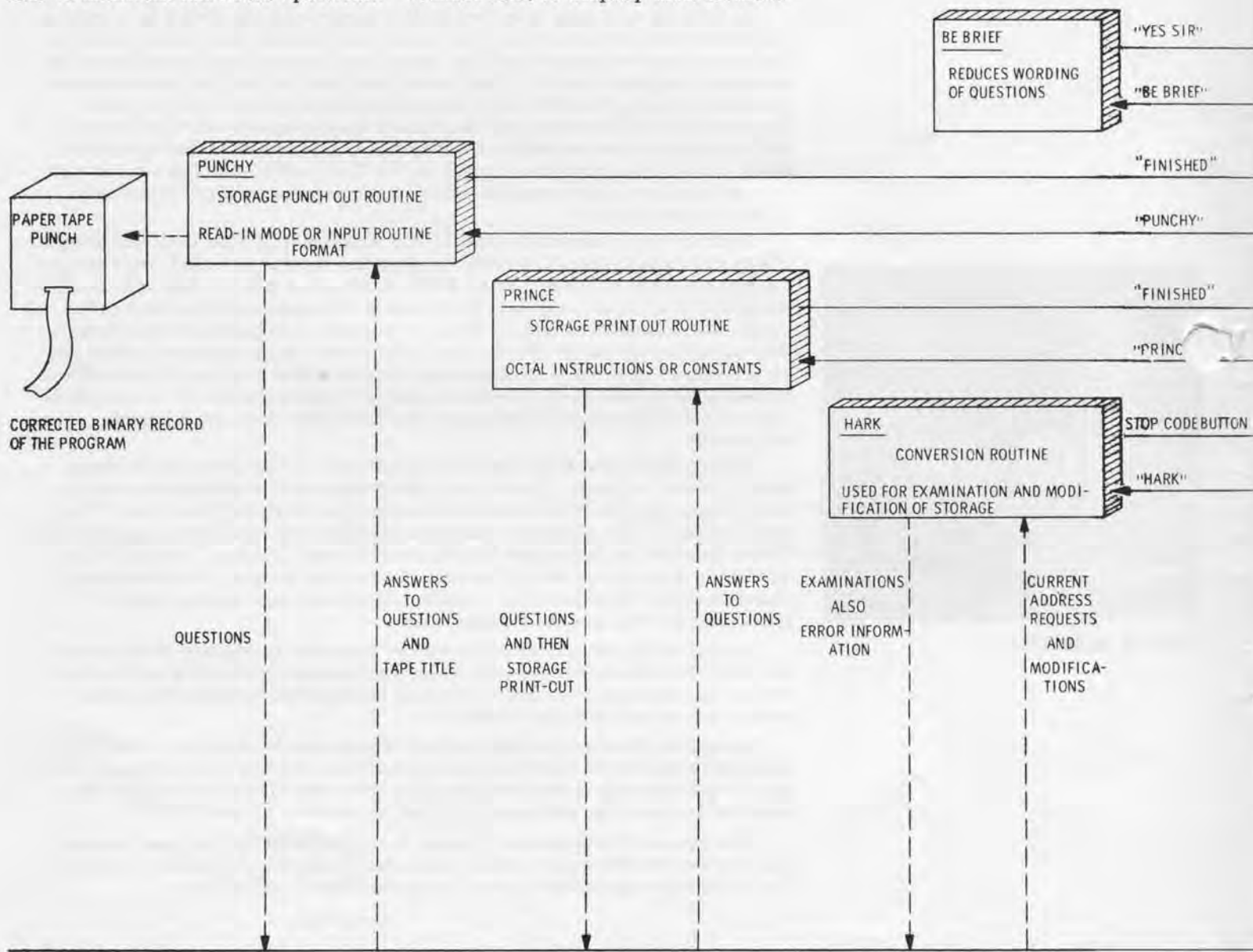

Museum's archives. Included in the program was a lecture by TX-0 alumni and MIT Professor Jack Dennis on the history of the machine; a luncheon for the alumni; and a hands-on demonstration of the star attraction—the TX-0.

One alumni favorite was the mouse and maze program. Everyone

focused on the mouse as he scurried across the cathode ray tube (CRT) screen to catch a piece of cheese. Old stories about the TX-0 abounded during the reunion with some alumni suggesting they should have brought cards for old times' sake, because bridge was often played during breaks in the TX-0 room.

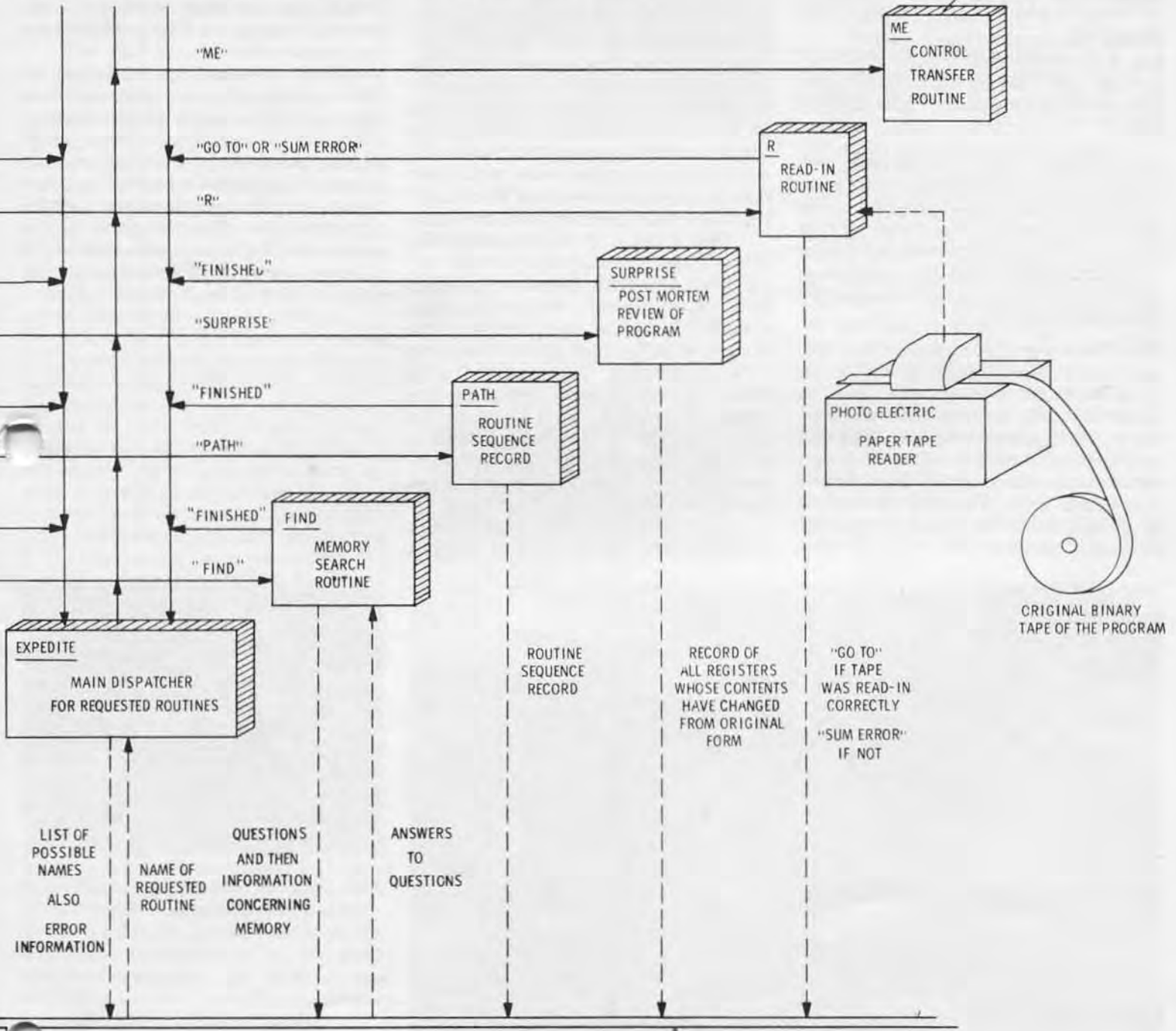

FIG. 2

TX-0 DIRECT INPUT UTILITY SYSTEM



The TX-0 at Lincoln Labs

The TX-0 and its original software were created at Lincoln Laboratory. Its original team included Wesley Clark as the logic designer and Ken Olsen as the engineer in charge of building the machine. Phil Peterson, Jack Gilmore, John Frankovich and Jim Forgie worked on logic design under Wes Clark. Bob Hudson and Chuck Norman were involved in the construction working for Ken Olsen in the engineering group.

The following quotes are excerpts from discussions and presentations at the Museum's TX-0 alumni reunion held November 13th.

Jack Gilmore: The racks of logic that became the TX-0 were used to test both transistor circuitry and one-half of the 65K memory for the TX-2 computer that was on the drawing boards. Ironically, when everything was put together it turned out to be a fascinating general-purpose computer.

Phil Peterson: Imagine when the power was first turned on. We had no other machine to talk to the TX-0. In order to communicate with the machine, the toggle switch panel allowed a sequence of bootstraps so that you could start a function, such as read-in the paper tape. The first thing we wrote was an octal assembler to read-in symbolic codes.

Architecturally, the machine introduced the idea of micro-coding. You could hit the carry pulse having never done anything else. A random number generator that would make nice little patterns on the face of the CRT could be done with no instruction. Once the programmers got the idea of micro-programming they were only limited in their experiments by their imagination.

Jack Gilmore: Wes Clark wrote an assembler called Hark. It was arranged so that the symbolic addresses could be any length symbolic string, so we could incorporate English-language words, making programs easier to read. We put together one of the first on-line operating systems that could input software in a very easy fashion.

One of the most significant pieces of work was a brain-wave pattern recognition program. Because the TX-0 had 65K of memory and an analog-digital I/O device, brain wave information was brought in as a moving window display. We were trying to teach the machine to recognize the "sleeping spindle." And because the TX-0 was the first machine with a coupled light pen and oscilloscope, the work was done four to five times faster than without these features.

Jim and Karma Forgie did voice recognition on the TX-0 before they did

it on the TX-2. Because the program took 10-20 minutes to execute, Jim had the problem of finding out where was. We rigged up a technique so he could draw a flow chart, put it on celluloid over the CRT, and in his software, slow down or speed up the program from the toggle switches. He could literally watch the voice program running through its steps. He could trap it and see it at a particular iteration using the Flexowriter or the toggle switches.

Most software was for testing the 65K memory. The complete cadre of software included a print program, Hark, the assembler, a technique for online assembling, a search program to search through memory and find things, a debugging routine, and the dynamic flow chart program. A fair amount of this initial software was not usable for the new 4K environment that the TX-0 had when it moved to MIT.



Jack Gilmore and others from Lincoln Labs reminisce about the first years of the TX-0.

In July 1958, the TX-0 was taken out of Lincoln Laboratories and installed in room 26-248 at MIT. John McKenzie recorded that it took 100 days of work to get the machine up and running.

The following is from a memorandum, dated July 23, 1958, to TX-0 users from Earle W. Pughe, Jr.:

This memo is written as an aide to those who wish to write programs for the computer before the computer is in operation.

The TX-0 has 4096 words of magnetic core storage. The cycle time is six microseconds, thus each order normally will take twelve microseconds. The inputs consist of a direct typewriter and a photo-electric tape reader. The outputs are a typewriter, a paper tape punch and a display scope. Other inputs and outputs are the toggle switch register and indicator lights on the control console. Provision has been made for users to connect their own equipment to the computer.

It is expected that in the future the TX-0 computer will have more orders and more memory. Every effort will be made not to obsolete existing programs as new features are added.

However to help meet the objective of not obsoleting programs as the computer is modified, the unused bits of an instruction must be zeros. This restriction means that such tricks as shifting a word to change instructions will obsolete a program when changes are made to the computer. Bits "0" and "1" are now used for the instruction, bits "6" thru "17" are now used for the address and bits "2", "3", "4" and "5" must be zero for all orders except "operate."

The Ad Hoc Committee on Experimental Computation (Chairman: Prof. J. F. Reintjes) is the faculty group in charge of the computer and they have final decision as to who may use the computer. It is expected that with the cooperation of the users there will be a minimum of paper work in assigning computer time. Since the computer is to be used for experiments instead of for numerical computations, the blocks of assigned computer time will be considerably longer than with other types of computers.



Professor Jack Dennis, who was responsible for the operations of the TX-0 at MIT, gave an overview of its evolution and use at the Institute.

The Speech Research Group at MIT. Osamu Fujimura, Hiroya Fujisaka, John Heinz, Gordon Bell (with his hand over his mouth) and Professor Ken Stevens watch Pete Brady at the TX-0 console in 1959 at MIT.



Professor Jack Dennis: Because the TX-0 was created as a memory test computer, it had some peculiar characteristics. The size of the address for the TX-2 memory was 16 bits, while the TX-0 had an 18-bit word. How do you build a machine with a 16-bit address and an 18-bit word size? Since an ordinary single-address instruction format was used, only two bits were left for the operation code.

Wesley Clark was a major force behind both computers. When asked what happened to the TX-1, his response was, "We don't build odd computers." So the plans for the TX-1 were scrapped just like the DEC PDP-3.

Ben Gurly was responsible for engineering the display system for the TX-0, a unique piece of hardware that influenced his later design of the PDP-1 at DEC. The TX-0 was one of the earliest computers that allowed the operator to use the cathode ray tube for interactive computation. In contrast, the displays on the Whirlwind were mostly used for recording information. The TX-0 display was used to show immediately the results of changes made to a program.

In the fall of 1958 I had just finished my doctoral thesis and had been appointed instructor at MIT. I also had just moved into an office in Building 26 near the TX-0. Not wishing to pursue

further my doctoral investigations in operations research, I was open to new and interesting adventures. With a new computer down the hall, the hackery in my blood soon got me involved in its programs.

This computer, unlike MIT's number cruncher, the 7090, had the feature of being intimate with its users. You could actually go up to the console and ask the machine to execute instructions and programs specifically for you. The display program, which generated interesting patterns, triggered immediate reactions to fix it up and try it again. If one was careful in choosing the number in the "live" register of the machine, you could cause some wonderful patterns. You could do this with a program consisting of a single instruction—repeated endlessly. Such informal interaction with a computer was completely new to the world.

How do you build a sensible machine code with just two bits?

- 1) You must be able to store information into memory locations.
- 2) You must be able to get information out of the memory, so one can operate on it in the central processing unit. The TX-0 does not have an instruction code "load." In the TX-0, one got information into the accumulator by clearing the accumulator and then executing an "add" instruction.
- 3) The third instruction of the TX-0 was transfer negative: transfer control to the location specified by the address.
- 4) The operate instruction was next. Anything not done by the other three kinds of instructions was done by operate instructions. The remaining 16 bits instead of referring to a memory location were simply a micro-coded extension of the operation code. One combination would cause a point to be displayed on the cathode ray tube (CRT) whose coordinates were the right half of the accumulator and the left half of the accumulator. In the same instruction you could transform the contents of the accumulator so that it would cause (on the next repetition of instruction) a different point to be plotted on the CRT.

Debugging

In the fifties a substance called FLIT was used regularly around the house to get rid of flies. Thomas Stockham and I called the debugging program we wrote for the TX-0, FLIT, which meant Flexowriter Interrogation Tape. It was a successor to UT3 written at Lincoln Laboratory and provided a medium for symbolic debugging. You could take the symbol table generated by the assembly program and load it into the debugger. The debugger could then talk to you about your program in terms of your symbolic addresses and symbolic instruction codes.

FLIT allowed one to insert breakpoints in a program and then run it. The debugger would take over control whenever a breakpoint was reached, whereupon the user could interrogate the state of a program and decide to go on or not.

The project to write FLIT was suggested by Professor Thomas Stockham who, perchance, shared my office in Building 26. We wanted FLIT to be a very interactive program, but we could not work with the cathode ray display, perhaps because the character tables would take up too much memory. But more likely because many users would want to debug programs that used the

display. Tom suggested that as soon as the typist had typed something that was in error—something that would not make sense for any continuation—the program should tell the user about it. Tom invented an idea he called "handslapping." Immediately upon typing an error, the program would type back a red question mark. This meant a lot of repairs to the Flexowriter because one would try to continue while it was typing back at you. Full-duplex communication and displays have now eliminated that problem.

About this time I heard of something called a "macro assembly" program and that Doug McIlroy had programmed one at Bell Labs. From this inspiration I wrote the program MACRO for the TX-0. This program was to lead to macro assemblers for the PDP-1 and other computers. MACRO turned out to be a large program. To debug it, it was necessary to use a simpler debugging tool than FLIT because FLIT took up too much memory, so I wrote a program called MicroFLIT. FLIT and MicroFLIT were forerunners of debuggers written for other computers, including DDT (Digital Debugging Tape) written by Alan Kotok for the PDP-1.

Alan Kotok. TX-0 alumni Alan Kotok (center) recalls his TX-0 days at MIT as Jack Dennis (left) and John McKenzie (right) look on.



Managing the TX-0

After the TX-0 had been at MIT for about a year and half, I took over responsibility for the machine and immediately set about extending the machine's instruction code. Since we were not likely to afford the 65,000 registers the TX-2 had, we enlarged the op code to four bits and added an index register. The operate command was redesigned to provide more capability, including logical "and" and "or", and more input/output orders. With these changes the TX-0 lost its original power to generate fancy patterns through repeated executions of a single instruction.

Installing the new instruction set was a big undertaking. The machine was constantly in use by research staff and students. We made the changes by pulling one panel at a time during scheduled maintenance periods, and almost always had the machine back in operation on time. The correctness of the alterations had already been checked through simulation using a register transfer language to describe the new instruction set.

John McKenzie has managed every move the TX-0 has made, and managed operation and maintenance of the machine while it was at MIT. He can tell you what it was like to replace the switches on the TX-0 console. I recall that when the machine first arrived at MIT, several switches had special designations: one was labelled "Suppress Wes;" and another was labelled "Dump Phil." These functions, doubtlessly referring to Wes Clark and Phil Peterson, are no longer present in the machine.

In my time one principle user of the machine was Gordon Bell who was working with Professor Ken Stevens and Arthur House on speech recognition. Pattern recognition was of great interest also.

Some of the people who worked on the TX-0 became heads of the Information Processing Technology Office (IPTO) of the Advanced Research Projects Agency of the government, where MIT has obtained lots of money to carry out research. One of the directors of IPTO was Ivan Sutherland, who created the program "Sketchpad" on the TX-2. This benchmark graphics program allowed a user to create sketches on the display by using a light pen. Using the TX-0 light pen, Ivan and Claude Shannon wrote a pro-

gram that would search a maze. It would act like it was inside a cave and would decide how to move by following the walls.

Larry Roberts, who also became director of IPTO, used the TX-0 for creating a kind of artificial intelligence program. His program recognized hand-drawn letters by learning from its experience.

In 1961, when John McCarthy was advocating timesharing as a way to use computers effectively and DEC donated a PDP-1 computer to the Electrical Engineering Department, my attention shifted to building a time-sharing system around the new machine.



TX-0 transistor. The first TX-0 transistors were in tubes to make it easier to test and replace them. The TX-0 had only 12 transistor failures, and almost every transistor that lasted more than 500 hours is still operational today.

Maintaining the TX-0

John McKenzie: When the TX-0 was built, transistors that operated at a five megahertz speed were not available. Lincoln Lab put Philco surface-barrier transistors, costing \$40 each, into bottles that contained 10 transistors. These were designed to be tested in a "transistor-checker." Ken Olsen, Ben Gurley and other designers didn't know whether transistors were here to stay. The engineers thought they might have to replace transistors like they replaced vacuum tubes, or at least annually check them. With little deterioration after 10,000 hours, it was clear that these transistors were good. It wasn't worthwhile testing them anymore. No one cared and the industry was moving ahead to new products. At MIT, only a dozen unaccountable failures may have been due to transistors. Most transistor failures occurred within 500 hours after installation. Otherwise they made it, and are still working today.

Every time another feature was added to the machine, another power supply was added as a self-contained unit. The machine is cycled on in sequence and cycled off in sequence. You get the memory pulses before you turn on the read-write memory current.



John McKenzie, who spent months revitalizing the TX-0 for its Computer Museum debut, enjoys watching the machine perform on TX-0 alumni day.

Electronic Systems Lab Group

Doug Ross: John Ward had only observed the art of programming on the Whirlwind. When the TX-0 came, John decided he should program.

John Ward: I signed up and there I was in the room alone with the computer. I was terrified.

Doug Ross: Earlier at Egeland Air Force we built an elementary mouse solving a maze problem on the 1103. So John and I did a mouse and maze program. I did the logic and John the display.

John Ward: . . . very slowly. There was no assembler. You had to figure out all the addresses yourself. The style of the program was reminiscent of Shannon's mouse that used relays.

Doug Ross: It had more flexibility because we were able to use the light pen to place the mouse and either hide the three chunks of cheese or the three martinis.

For MIT's centennial in 1961, CBS did some specials on the Institute. The CBS director said, "Gee, Westerns are so cut and dried couldn't you write a program for one?" And I was talked into it. The memory was used to keep track of everything down to the actors' hands. The logic choreographed the movement of each object, hands, guns, glasses, doors, etc. A line of English script was written for each direction, even if it went wrong. That's how we got the loop sequence which was an actual error run. If you watch closely, the sheriff puts his gun in the robber's holster, and other strange things.



Doug Ross. Seated at the TX-0's "L" shaped console, Ross explains how he and John Ward designed the Mouse and Maze program: "I did the logic and John did the display."

Doug Ross explains the flowchart for the logical choices in "Saga," the 1961 TX-0-written Western.



Dit Morse: I've been asked if the error sequence was rigged. Well, it turns out that the CBS people were in the TX-0 room when the machine got into that loop. They saw what the programmer was doing and they grabbed that sucker so fast—they knew it was theater.

The program's 13,000 line code was macro generated. One of the first and only programs that I wrote with a real deadline. CBS would not postpone the shooting under any circumstances. It took six calendar weeks to deliver six skits.



Cognitive Information Processing Group (CIPG)

Don Troxel: As a graduate student I used the TX-0 because I had alot numbers to reduce statistically, and was the best desk calculator around. People in our group started to use it because of the display capability. At CIPG under the late Sam Mason we measured reading speed.

John Allen: The first speech synthesis by rules scheme introduced in England by Holmes, Mattingly, and Scherm was first implemented on the TX-0. It made heavy use of this wonderful bank of switches to control the various parameters of that synthesis.

Don Troxel: When Francis Li called me over to hear it, I expected it to have a Chinese accent, but it had an English one since that was where the rules were made.

John Allen: We did experiments with pitch using the switches for control. The TX-0 and PDP-1 were used to start to build a reading machine for the blind. The character recognition part ran on the PDP-1 and the speech synthesis on the TX-0. The tenuous connection was often lashed together firmly enough so that we could read characters on the PDP-1 and ha speech output on the TX-0.

When John McKenzie let you turn the machine on, you were then part of the in group. One Saturday, a professor, who will go nameless, called me on the phone and said, "I just turned the TX-0 on and it won't go."

I said, "Just put your hands on the console and don't do anything until I arrive." Fortunately he hadn't done anything disastrous. He just hadn't started up the clock sequence.

Gordon Bell: Actually with improper clocks when you started you could ruin the core memory.

John Allen: The price of the TX-0 was \$3 million—from the development costs on the books at MIT.

Gordon Bell: That was a bargain because it led directly to the TX-2 and Digital Equipment's first products.

Actor Jack Gilford played the role of the robber in a "shoot out with the sheriff." The climax of "Saga" written in 1961 by the TX-0 with the help of programmers Dit Morse and Doug Ross.

Speech Research Laboratory of the Research Laboratory for Electronics

Gordon Bell: I was a member of the search staff of Professor Kenneth Stevens' speech research laboratory. The laboratory continues to train researchers and do research in analysis and synthesis of speech. Some colleagues who worked on the TX-0 included Arthur House, now at the Institute for Defense Analysis; Osamu Fujimura of Bell Labs; Hiroya Fujisaki, University of Tokyo; John Heinz, John Hopkins; Morris Halle, MIT, and Pete Brady.

Speech was taken into the computer using a tape loop with sampling pulses on one tape channel. The audio (speech) signal was passed through a bank of 24 filters and read in via TX-0's Epsco analog-to-digital converter. The goal was to recognize the speech by analyzing the frequencies of the resulting acoustic input. The analysis was carried out by a technique we invented called analysis-by-synthesis; the computer posted a model of the speech and compared it with that to be analyzed by adjusting the model's parameters.



Reminiscing. *Shag Graetz's first hands-on programming experience was at the TX-0 console, although he was a seasoned programmer before coming to MIT.*



Gathering vignettes. *Steve Levey (left) who is writing a book on hackers, gathers tidbits from recollections of Electronic Systems Lab group alumni Doug Ross (center) and Harrison (Dit) Morse.*

The Hackers

Alan Kotok: In the fall of 1958, I was one of the earliest of the undergraduate crew to come in. Jack gave a couple of introductory talks to the Tech model railroad crowd, and brought us over to demonstrate the TX-0. When we saw it, we said, "Oh, neat—there's all this time available." We negotiated with Earle Pughe and John McKenzie for time. They said if the faculty advisor was amenable, then we could use the machine without any supervision.

Jack Dennis: As an undergraduate I wrote a large linear program on the Whirlwind to solve the transportation problem. After midnight, I could get my hands directly on the Whirlwind, and get scope postmortems all on my own. This led me to believe that informal direct programming by students was the way to work with machines. Then we formalized it on the TX-0.

Dave Gross: I was a freshman at MIT in 1957 and got a tour of the new TX-0 computer room. In 1958 we, the model railroaders, discovered the TX-0. I was told that under no circumstances could I turn it on, since I was not an authorized user. The most elaborate program I wrote for the machine was a three by three matrix of dots that made a search. One night Alan Kotok and I had the idea that it would be awfully nice if you didn't have to run your program tape through the reader twice. So we wrote a program that put it on mag tape the first time with enough space for binary to be added.

Alan Kotok: Before that no one had used the tape except to write from the beginning and fill it full. Here we wrote—and then left space along the way.

Dave Gross: We tuned it to leave just the right amount of space.

Alan Kotok: We put two load points on all tapes, with the utility at the beginning and then a point that allowed use at the end. We did anything to avoid having to punch another binary program on this Flexowriter that punches ten characters per second.

Dave Gross: Alan, do you remember the expensive tape recorder program? You had your FM receiver here in the computer room and we said we'd hook up the audio to the A to D converter and write a program to record on that tape.

Alan Kotok: That was digital recording more than 20 years ahead of its time.

Dave Gross: It would write the whole tape as one long record. Play back through the accumulator created a whistle, so we used the scope's D/A converter fed back into the speaker that was under the console.

Jack Dennis: Could you recognize Beethoven?

Alan Kotok and Dave Gross: It wasn't bad, considering . . .

Alan Kotok: After the PDP-1 arrived and before any of the fancy high speed links had been installed between the machines, the hackers of the day and I were contemplating how we could make use of both computers. We hooked up a serial line between the two with a buffered program to the typewriter. You could type a line at one machine and it would come out on the other.

After we got it working, I said, "What can we do with this?"

Someone said, "Play chess."

Since some of us had been working on chess on the 7090, we got together a panel of chess players in the TX-0 room with a chess board. Some of us sat in the PDP-1 room with a chess board and waited for an unsuspecting chess player to walk down the hall and into the room. Some fairly gullible graduate student was enticed to play this great new PDP-1 chess program. Our victim typed his plays in. The group in the other room replied. It worked well for a while, but then there was confusion about one of the moves with an argument over the terminal. Alas, our victim smelled a rat and started for the door to the connecting TX-0 room.

Gordon Bell: In the spring of 1960, I went out to DEC and bought some modules so that we could add a mag tape unit on the machine.

Alan Kotok: And that took us into big time computing.

Jack Dennis: I remember that my dream at the time was getting support for interactive programming on the TX-0, even though the one itty-bitty tape unit was the only bit of auxiliary storage we had. I was dreaming up schemes to keep peoples' files and images on this tape unit, so that one user could take the machine over from another, but that project was scuttled when the PDP-1 arrived in 1961. Then we started to use it to build a timesharing system.

Shag Graetz: By 1961 this machine was a legend among programmers. I had been eased out of the nest at Harvard where I used the 704, with about three times this amount of equipment, that no ordinary programmer could ever use. I came to write a diagnostic program for the 906/2 tape drive—every bit the kludge that it appears to be.

My first question was, "Who is the operator and how do I submit my programs?" Jack Dennis said, "This is it. What you see is what you get." The entire room of machinery was under the control of whoever was signed up to use it at the time. During the next academic year, I went to work for Doug Ross; the PDP-1 arrived and I moved over to work on it, where in our spare time we developed SPACEWAR!

Deja vu. John McKenzie who was the technician on the TX-0 at MIT, once again readies the machine, but this time at The Computer Museum.



The Move to the Museum

John McKenzie: The TX-0's life came to an end when each of the labs got their very own computers. When I saw a note in the paper that Bob Everett was presenting the Whirlwind to the Smithsonian, then I thought that's the place for the TX-0. However, they weren't interested. A little bit later, I saw a short paragraph in a DECUS newsletter that DEC was starting a museum. And we said that was the way to go. Stan Schultz came down and we started to plan the move. We were about to move the machine on April 19th (a holiday), when the contract officer at MIT said, "Hey you can't give away this \$3 million to a private individual." Everything came to a halt for two years. First it had to be offered to all military groups, then to all groups with government contracts, then various universities, then secondary schools, and finally to general services who could advertise it. On the first go-around DEC was outbid \$2500 by an outfit in St. Louis that wanted the I/O. Then it was re-advertised. This time DEC was outbid \$50 by a surplus dealer in Ohio. Roy Gould got busy on the phone and noted that it would cost a lot more than the price of \$350 to move the machine. DEC gave them an extra \$100 and took title to the machine.

Here we go! Flipping switches while watching the indicator lights on the control console of the TX-0, John McKenzie prepares the machine for operation.



Stan Schultz: John Connally and I spent many hours labelling all the wires.

John McKenzie: The dismantling took about a week, and then unfortunately it went into a warehouse for about two years.

Stan Schultz: Initially we set up the processor and console, and it was on exhibit from the summer of 1979 until 1981.

John McKenzie: We never burned any bridges so that we could make it run again. Fifteen different power supplies were lost in the warehouse. Then we had to buy some new ones. But the CPU is pure.

Twice in bringing up the machine I was stymied. Once with the core memory, and I called on Dick Best to do some circuit analysis and he got me out of that hole. Later on, in setting up the paper tape reader, Alan Kotok did some analysis and we made it work. It needs to be in a computer room environment with a cooler, steady temperature.

Stan Schultz: While on exhibit, some people must have taken souvenir bottles from the console. When we let it be known that the machine was being brought up again, bottles would mysteriously appear on the console.



The TX-0 at The Computer Museum in Marlboro. With the Museum closed and moving to Boston, the TX-0 will once again be packed, moved and reconstructed in a new location. This is the fourth move for a machine that started out as transistor-test circuitry and may end up as the longest-living operating computer.

Computing at Burndy Corporation

by Gregory W. Welch

The clacking of paper on plastic as a pile of cards is jostled into alignment. The shuffling and slapping of paper cards traveling at high-speed through mechanical sorting devices; the whirring of electric motors; and the clicking of relays. These were the sounds of an office in days-gone-by, right? Wrong!

Until last November these were the everyday sounds of the Accounts Receivable Department at Burndy Corporation in Norwalk, Connecticut. The source of these noises was the collection of old IBM card accounting machines upon which Burndy still kept its accounts receivable. However, after over 30 years of faithful service, these anachronisms were finally being retired, to be replaced by a soundlessly efficient Univac 1100/82.

Unlike most machines their age, these antiques were not destined for "that great metal crusher in the sky." Instead, and quite rightly, they were to be enshrined as representative of a breed of machines which for years was the standard of office automation. They were headed for The Computer Museum.

In the 1940's Burndy Corporation, then located in New York City, started leasing IBM card accounting machines to manage various functions of its operations, such as keeping track of inventory, performing sales analysis, engineering applications, production control, and accounting operations. By 1950, when Burndy moved to Norwalk, it employed approximately 25 people working two shifts to operate its close-to 30 machines.

The card machines were run in much the same way a modern, batch-processing computer center is today. A given department would submit written documents to keypunch operators, who would punch the data contained therein onto 12-by-80 character computer cards. These cards would then be sorted, collated, calculated, reproduced, interpreted, or printed according to the wishes of the department requiring the information. However, each of these operations was performed by a separate machine. Hence, it was up to the operator to perform the functions of a central processing unit, such as synchronising the operations and transferring the data from one

machine to the next. The "program" was the department's instructions to the operator as to what they wanted done with the data.

In the early 1960's Burndy began to modernize its office equipment when it up-graded to an IBM 1401 system. Over time it continued to transfer more of its operations to computers. As it did so, its appetite for computer power increased. Burndy soon moved on to an IBM 360/40, then to an RCA Spectra 70, a Univac 1100/11, a Univac 1100/81, and finally a Univac 1100/82. Concurrently, since the number of operations to which the accounting machines were applied was steadily decreasing, Burndy retained fewer and fewer in service. The equipment was bought from IBM by MAI, a leasing company, that continued to lease it to Burndy and service it.

According to Marjorie L. Canto, Manager of Burndy's EDP, User Support Service Department, by "late in the 1970's approximately 90 percent of the Burndy functions had been automated." Finally, with only a couple of functions being filled by the card machines Burndy bought one of each type outright. The last of these functions to be automated was accounts receivable, which made the switch over to the 1100/82 in November of 1983.

With the last of the card accounting machines being phased out, Burndy looked for an appropriate end

for these machines which had been a part of its operations for so long. Knowing that Burn Dibner, the founder of Burndy, was very interested in history, Ms. Canto contacted him to see if he would want the machines. He suggested that she contact The Computer Museum to investigate the possibility of donating them. When Ms. Canto approached us, at first we were unsure what these machines were, let alone what their historical significance was. However, after a trip down to Norwalk to inspect them—and seeing them in running order—and several phone calls to IBM, we decided to accept one working example of each of the four types of machines Burndy still had. These were: a #557 Interpreter, serial# 16592; a #083 Sorter, serial# 16329; a #088 Collator, serial# 17000; and a #519 Reproducer, serial# 40093.

The Interpreter is used to print, in alphanumeric characters, some or all of the information encoded in the holes of a card on specified areas on the face

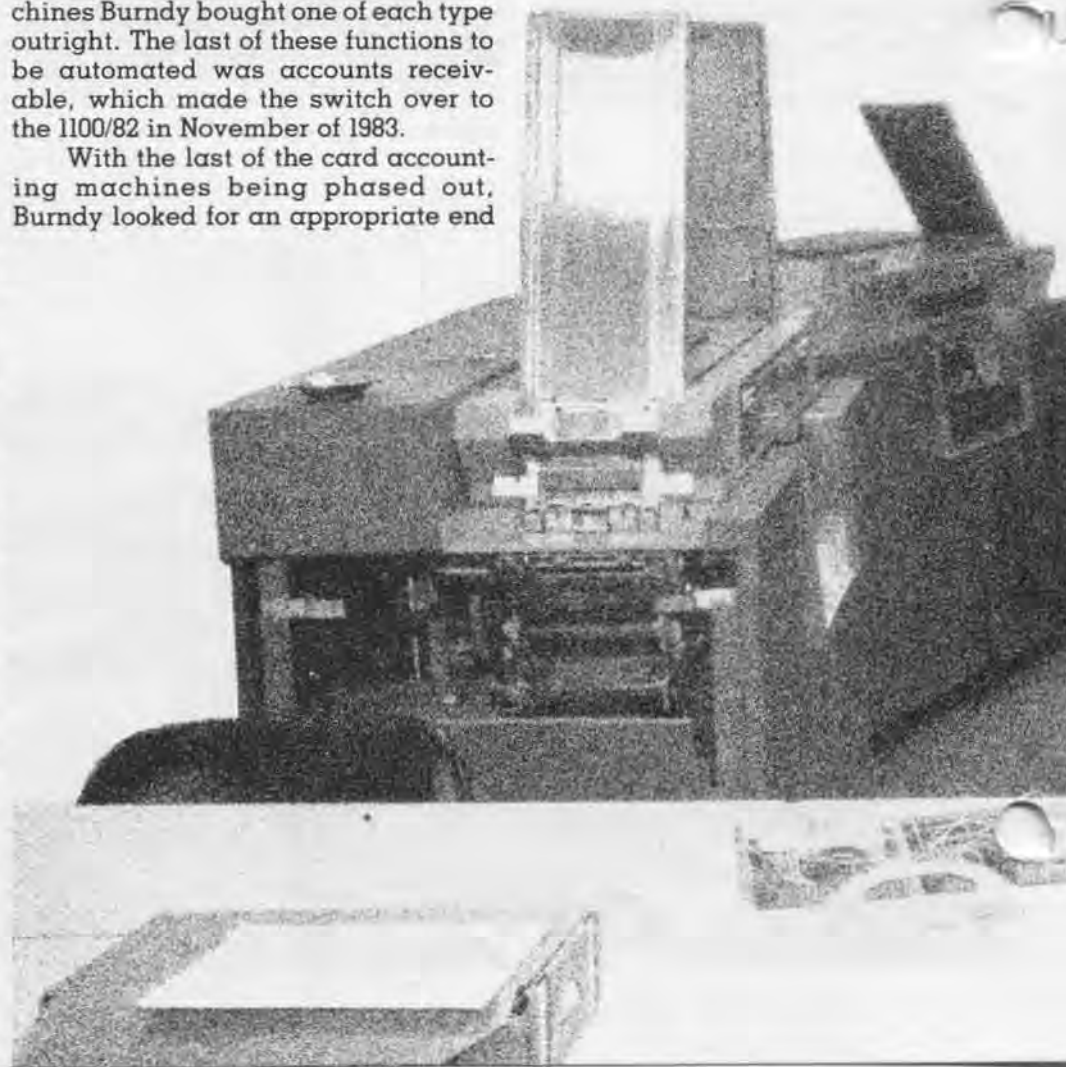

of the card, according to a program
wired on a plug board.

The Sorter separates a stack of cards into piles having the same value in a particular column. The setting of a contact brush, which reads one column at a time, determines which field the stack will be sorted on. It can also be set to only select cards with a particular value (or values) in a column.

The Collator merges two similarly sorted stacks of cards together under the instruction of a wired plug board.

The Reproducer simply reproduces a stack of cards in part or in whole, again controlled by the wiring of a plug board.

It was machines such as these with which IBM dominated the pre-computer business machine market, giving them an advantage when the business computer market blossomed. Therefore, they are of significant historical importance because they represent the formation of the marketplace which was the foundation of IBM's computer business.

As operational artifacts of historical value, and their operativeness, they will make wonderful exhibit pieces. Visitors will not only be able to view the early products of the world's largest computer company, but also hear and see the whirring, slapping, clicking and clacking that was computing before computers.

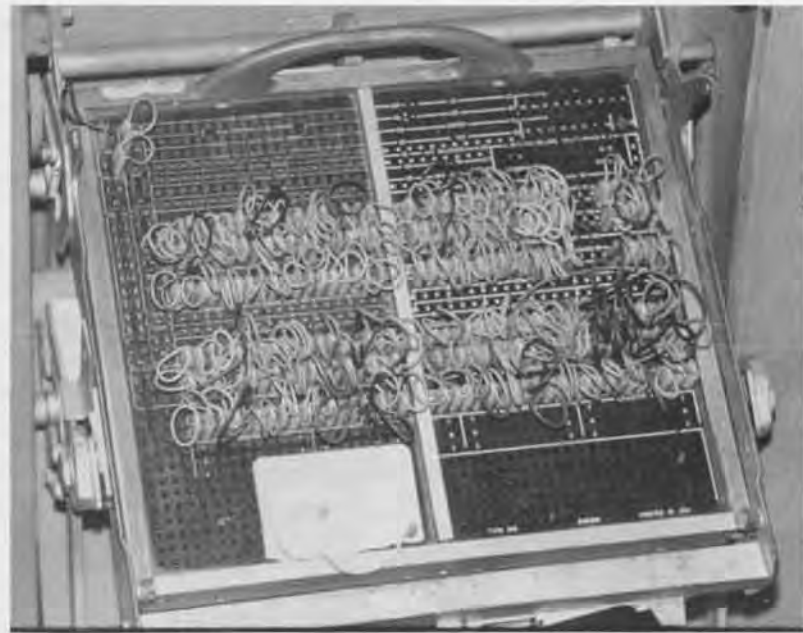

Plugboard Program Central Unit.

Card Accounting Machines. *The complete card computing installation at Burndy Corporation, pictured here, filled an entire room. The varied components are now part of the Museum's collection.*

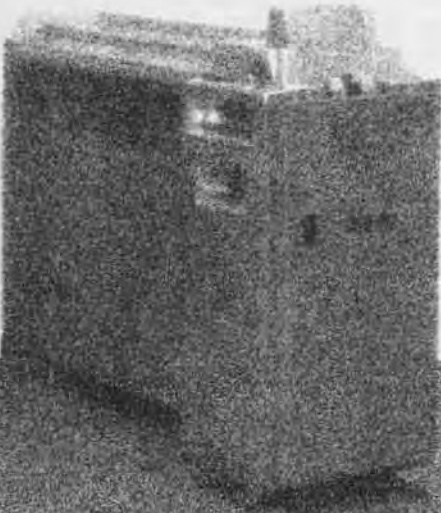

Inside Stories on Computer History Told at Fall Programs



Stories of untimely mechanical failures, eccentric bosses and annoying bugs; conventional narratives; and demonstrations of classic machines highlighted the series of 15 educational programs and events sponsored by The Computer Museum this fall.

The season was a success by all counts, attracting more than 1500 visitors and members. They learned about computing history and its impact on society through films, gallery talks and lectures by computing pioneers.

A tour of the Museum's new quarters in downtown Boston on September 11th got the season off to a lively start. Members viewed the open space in Museum Wharf and heard about the Museum's gallery plans—from the two-story exhibit for the gigantic SAGE computer to the plans for expanding the generations galleries.

A week later, the Museum's new, circa 1974 Kurzweil Reading Machine for the blind was introduced by Gail Yarnell and Randy Stern of Kurzweil Computer Products. Stern told how the software designers demonstrated the machine's peculiar accent, and Yarnell showed off the machine's reading capabilities by letting it read the "Star Spangled Banner" aloud.

On September 22nd, Alan Perlis shared some of his renowned computing epigrams at a Museum lecture

entitled "The Evolution of Software." Perlis, head of Yale University's Computer Science Department, told the audience that the 26-character IT software program he helped write at Carnegie Mellon was "personally, the high point" of his programming career. (See the Winter 83/84 Report for a synopsis of Perlis's lecture).

The Computer Museum's new Multiwire Wiring Machine inspired the next lecture by Joseph Hammond of PCK Technology on September 25th. He chronicled the history of multiwire technology and explained how it made smaller, more compact computers a reality.

Computer memorabilia reigned the following week, when the Museum sponsored its first yard sale on October 2nd. Machine nameplates, consoles and core memories sold the fastest. Counting them and the more obscure objects d' computer, the cash-and-carry sale grossed more than \$1000.

Just four days later, the focus changed dramatically as Dr. Jerrold Petrofsky stepped up to The Computer Museum podium to tell the story behind an invention that makes it possible for paraplegics to walk again.

His pioneering work made it possible for 22-year-old Nan Davis, who has been paralyzed from her waist down for four years, to walk with the

Incredible . . . no not the audience, but the presentation on computer graphics by Robert Langridge that required 3-dimensional glasses for the event.



Dr. Jerrold Petrofsky.

assistance of an electrical stimulation-feedback system designed by Petrofsky.

Then on October 9th, **R. Michael Hord**, author of *The ILLIAC IV, The First Supercomputer*, talked about that machine's achievements and shortcomings. Decommissioned and moved to the Museum in 1983, it had been one of the fastest and biggest machines of its time, capable of 300 million operations per second.

Computer research was the topic of discussion the following week when **Perry Crawford** of IBM's Systems Research Institute gave a talk entitled "Computing Decisions: What Good Ideas Have We Left Behind?" He said that "in terms of their development, computers are where cars were in 1910."

On October 20th, Analogic president **Bernard Gordon**, presented his perceptions of computer engineers from Eckert and Mauchly, inventors of one of the first digital electronic computers, to today's engineers.



Bernard Gordon (center).

Gordon said there has been a dramatic decline in engineering productivity since the days of Eckert and Mauchly. He attributed the change to overspecialization of engineering tasks, and recommended returning to a Renaissance approach—training and hiring well-rounded engineers who can tackle a variety of assignments. (A transcript of Bernard Gordon's lecture will be featured in the next issue of the Report.)

Then on October 23rd, Museum visitors learned the inside history of a revolutionary Harvard Mark I through Mark IV computers from **Robert V. D. Campbell**, one of the programmers involved with the project from the 1940s.

Sunday afternoon, October 30th, **Andries van Dam** presented two hours of classic films and video clips that illustrated the history and rapid expansion of computer graphics. Van Dam, chairman of Brown University's



Andries van Dam.

Computer Science Department, told the audience that computer graphics was such a new field in 1964 that it was difficult to find even 30 people to support a new computer graphics association called SIGGRAPH.

"See It Then," a Computer Museum movie featuring vintage films on early computers, showed the following Sunday to a full-house.

One of the season's highlights was an overview of product development at IBM presented by vice president **Bob O. Evans**, November 10th. Evans reviewed the alternating cycles of product diversity and standardization at IBM from meat slicers to card systems and whole families of computers. (A transcript of his talk will run in the next issue of the Report.)

Robert Noyce to Speak at Museum May 11th

Robert Noyce, inventor of the integrated circuit and vice chairman of Intel, will speak to Museum members and guests on May 11th at Museum Wharf, Boston.

It will be the first such event in the new quarters and will take place by partially completed exhibits. The Museum is not slated to open to the general public until this fall when the first four galleries will be complete.

The story of the TX-0, the star of the Museum's November 13th program, can be found elsewhere in this issue.

To complete the fall series, **Robert Langridge** gave an illustrated lecture on the use of 3-dimensional computer graphics for molecular research. Langridge, director of the Computer Graphics Laboratory at the University of California, San Francisco, described how interactive computer graphics are used to analyze genetic structures.



Robert Langridge.

Noyce's presentation continues the Museum's tradition of sponsoring lectures by computer pioneers. The lectures are videotaped for historic purposes and kept in the Museum's archives. Excerpts from the lectures are also featured in *The Computer Museum Report*.

The Sage Arrives. Cooperation of the Museum Wharf staff, the exhibits department and the movers were needed to heft a console of the SAGE Air Defense System into the elevator at the Museum's new quarters in Boston. The SAGE was the first machine to use command and control CRT display consoles on which operators identified targets by pointing at them with light pens. A total of 40,000 pounds of SAGE components were delivered in October. They will be used to recreate the SAGE installation at The Computer Museum.



The Members' Association and the Move to Boston

While it might have felt that way, packing up The Computer Museum and moving it to Boston wasn't anything like taking down a circus and magically re-appearing the next day.

In a series of packing parties that took place between January and March, the Members' Association lent over two hundred man-hours to the project—making the move to Boston a physical reality. "Party" is a loosely defined term here, because packing the Four Generations exhibit, the calculator cases, the Fairchild chip exhibit, the memory cases, and the super computers is a huge job.

The process began with the exhibits department acting as "advance men"—coming in ahead of time to pallette boxes, wrap toggles, put skins on certain machines, and take the "skirts" off others. Then, the job of packing could begin. Each piece had to be taken down from its resting place, assigned an inventory number, wrapped, boxed, and boxed again. It took Connie Bachman, Barbara Beeton, Joe Cascio, Helene Faguerquist, Reed Fleming, Kate Fulton, Shag Graetz, Ed Galvin, Ian MacLennan, Mary McKenney, Nick Reinhardt, Bill Ricker, Kitty Selfridge, Diane Sherman, and Alex Vanderberg, plus the entire exhibits department, a day to do the calculators and the Four Generations exhibit.

The job of getting the exhibits out the door and down to Boston was done by Almac Moving Company, that generously donated the entire cost of the move.

Packing and now unpacking provides a rare opportunity for some real "hands-on" interaction with the exhibits. "You find you really study a piece when you spend a half-hour wrapping it," according to one member.

If you would like to roll up your sleeves and help with the unpacking and the refit, please contact Chris Rudomin at (617) 426-2800. We need all the help we can get!

Museum Brings Computer History to Audiences Nationwide

A new film edited by the Museum is bringing computing history to life for computer rookies and aficionados from California to New York.

Called "See It Then: Classic Films of Early Computing," the 38-minute feature illustrates some of the benchmarks in computer history.

In the past six months, the Museum's director Gwen Bell has shown it to more than a dozen groups, including the Stanford IEEE student chapter in California, the Big Apple User's Group in New York, and the Association for Computing Machinery (ACM) in Philadelphia.

Museum members are sent invitations to such presentations made in their area. Dozens of Silicon Valley members came to the talk given there, and members came from Washington and New Jersey to see the Museum's presentation and visit its booth at the New York ACM conference in October.

New England area supporters will have a chance to view "See It Then" at the upcoming ELECTRO '84 trade show in Boston's Hynes Auditorium, May 15-

17, where it will be shown in the Museum's booth.

"See It Then" combines four classic clips of early computers. It features the ENIAC, one the first electronic digital computers, being programmed with plug boards. In the second segment, EDSAC designer Maurice Wilkes narrates a 1951 movie on the EDSAC that he calls a "commercial for micro-programming."

Next, the viewer sees Edward R. Murrow interviewing the Whirlwind computer and Jay Forrester, one of its designers, at MIT. The final clip features a computer-written Western acted out by Hollywood actors in a 1961 CBS special titled "The Thinking Machine." Narrators Wayne David and Jerome Weisner explore the question, "Can machines think?"

If your group is interested in a presentation by the director that includes "See It Then," contact Stephanie Haack, Communications Coordinator at The Computer Museum, 300 Congress Street, Boston, MA 02210.

What is a Founder?

Any individual or corporation who gives more than \$250 or \$2500 respectfully during the Museum's first two years.

On March 14, 1982, The Computer Museum was given provisional status until June 24, 1984 by the IRS as a public, non-profit charitable foundation. During this time, the Museum has to prove that it is indeed a widely supported public institution.

This is a unique opportunity to help establish the only international museum devoted exclusively to computers and the history of information processing.

Corporate Founders

American Federation of Information Processing Societies, Inc.
Apollo Computer, Inc.
Association for Computing Machinery
Automatic Data Processing, Inc.
Benton and Bowles
Bolt, Beranek and Newman
Boris Color Labs
British Computer Society
Robert Cipriani Associates
Clint Clemens
Codenoll Technology Corporation
Computer Science Press
ComputerWorld
Control Data Corporation
Convergent Technologies
Coopers and Lybrand, Boston
Data General
Dataproducts Corporation
Digital Equipment Corporation
Digital Equipment Computer Users Society
Ford Motor Company
Fujitsu Limited
General Systems Group, Inc.
GTE Data Services, Inc.
Hewlett Packard Company Foundation
IEEE Computer Society
Intel Corporation
International Telephone & Telegraph Corporation
Los Alamos National Laboratory
MDB Systems, Inc.
Microsystems Engineering Corporation
MITRE Corporation
MOCO, Inc.
Motorola, Inc.
National Semiconductor Corporation
OMNI Publications International, Ltd.
PCK Technology Division
Richard Reno
Schlumberger Foundation
Seldin Publishing
Software Results Corporation
Tobin Vending Service
The Travelers
Wang Laboratories
Xerox Corporation

New Individual Founders

November 1983 through January 24, 1984

Jeremy Barker
Gordon & Barbara Beeton
Roger & Kay Berger
Elizabeth Boiger
Max Burnet
Jim & Margaret Butler
John D. Clarke
William Congleton
Richard Corben
Jim Crapuchettes
Thomas D'Auria
Bruce Delagi
Gregory Del Sesto
Michael Dertouzos
Jean E. de Valpine
Nick De Wolf
Peter DeWolf
John Di Targiani
James Donaldson
Geoffrey Feldman & Sharon Lipp
Read T. Fleming
Clark Frazier
Donald George
Betsy Gillies
Robert Goldman
Karl M. Guttag
Sheryl Handler
Ardoth A. Hassler
Michael Hathaway
Nolan T. Jones
Paul A. Karger
Christopher Kent
Dr. Benn Konsynski
Robert L. Kusik
Glen Langdon, Jr.
Robert Langridge
T. G. Lewis
C. L. & Jane Liu
Robert F. Marsh
Thomas McIntyre
Donald & Jean Michie
The Morgan-Grampian Pub
Frank E. Morris
Saburo Muroga
David & Pat Nelson
Bill Newcomer
Curt Landon Noll
Nick Pettinella
Juan A. Pineda
James A. Pitts
K. F. Powell
Paul Repacholi
Dan Rose
Robert F. Rosin
Stephen Russell
Rebecca Schatz
Earl & Mary Schweppe
W. Lee Shevel
Thomas W. Simons
Robert Spinrad
John T. Stapleton
Gregory J. Tutunjian & Linda M. Watson
G. Michael Uhler
Alexander Vanderburgh
Susan Walter
Joseph B. Walters, Jr.
Herbert Willman
Norman Wilson

Join the Museum

Name _____
Address _____
City/Town _____
State _____ Zip _____

Please enter a membership in the following category:

- Member \$25
 Founder \$250
 Corporate Founder \$2500

All members receive the quarterly Museum Report, a 10% discount on Museum Store purchases, and announcements of Museum programs and events. All membership contributions are tax-deductible within the limits provided by law.

To become a Member or Founder fill out this coupon and return it with your check or money order to:

Membership Coordinator

The Computer Museum

300 Congress Street
Boston, MA 02210

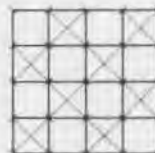

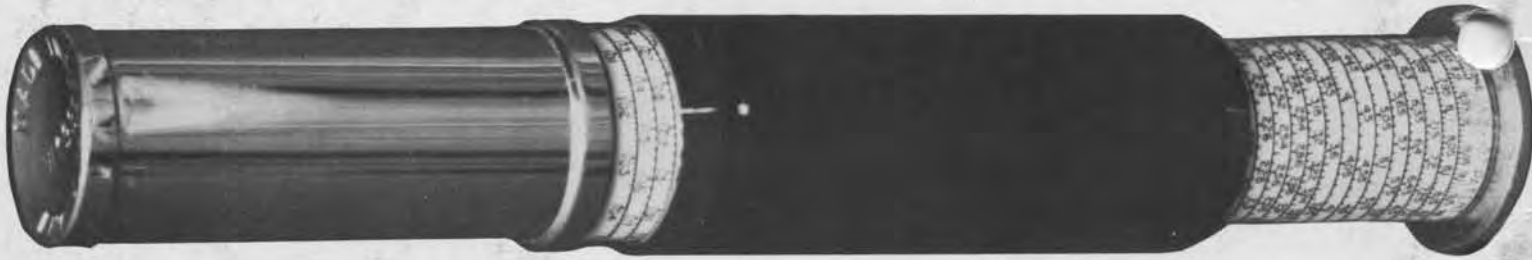
A newsbrief of the collection

Otis King's Pocket Calculator is a rare pocket-sized cylindrical slide rule manufactured by Carbic, Ltd. in London in the early 1920's. The spiral logarithmic scale, printed on both the smaller rotating and larger fixed tubes (called "cylinder" and "holder") is a double scale with five places of accuracy. The cylinders can be moved relative to each other either axially or rotationally. Two arrows at either end of the sliding black cover form the tubular cursor (that mark the logarithmic numbers and their roots).

Otis King's Pocket Calculator, gift of Harvard University Professor I. Bernard Cohen, was moved to Boston with the Calculator Collection in February and will be on permanent display in the Pre-Computing exhibit.

**The
Computer
Museum**

300 Congress Street
Boston, Massachusetts
02210

Non-Profit
Organization
U.S. Postage
PAID
Permit No. 110
Fitchburg, MA
01420



THE COMPUTER MUSEUM REPORT

NUMBER 9

SUMMER 1984

1911

International Time Recording Co. Computing Scale Co. Tabulating Machine Co.



Computing-Tabulating-Recording Co.

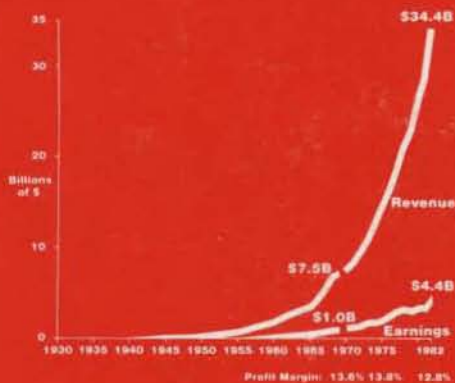
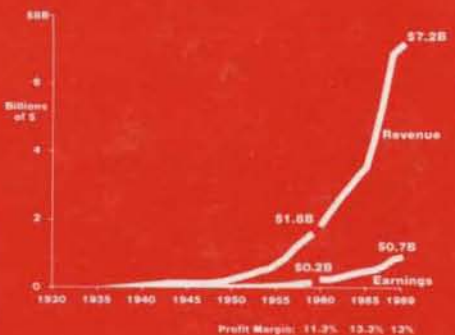
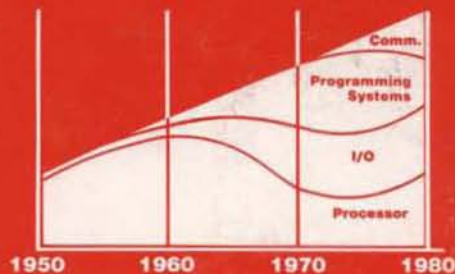
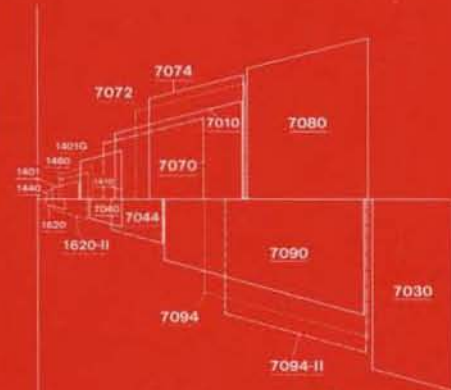
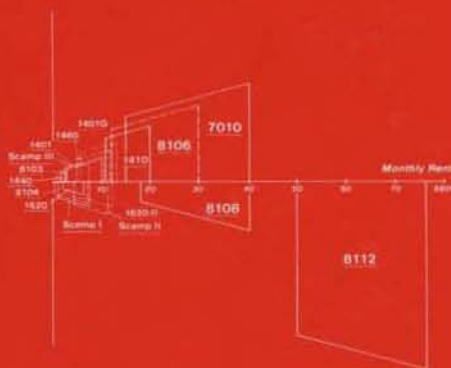
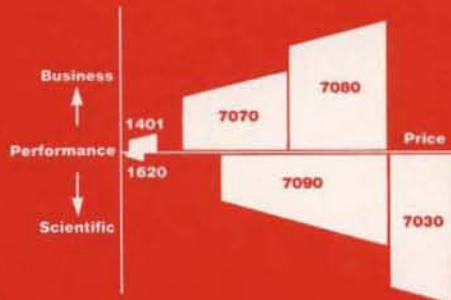
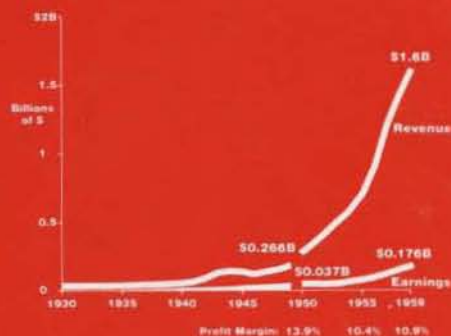
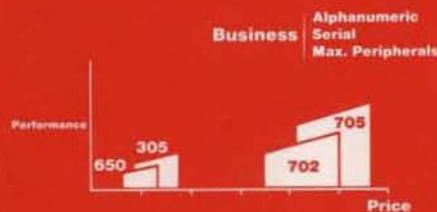
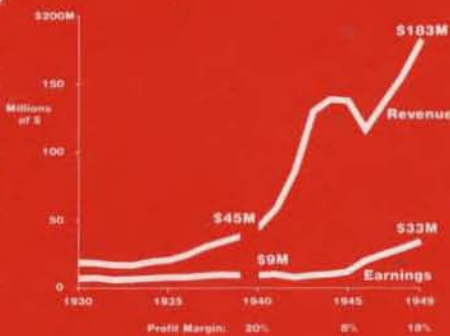
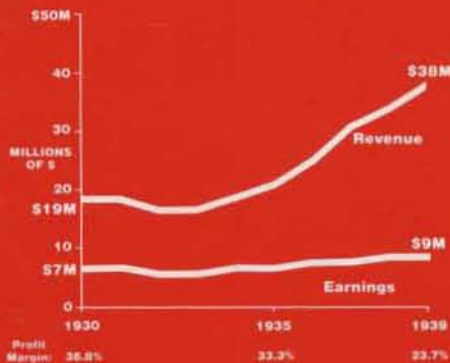

Inside:

IBM System/360
Bob O. Evans

Computer Engineering Attitudes
Bernard Gordon

Contents

- 1 The Director's Letter
- 2 Computer Engineering Attitudes
From Eckert-Mauchly to Analogic
Bernard Gordon
- 9 IBM System/360
Bob O. Evans
- 19 Museum News
- 20 Membership Coupon
- 21 Founders
The End Bit
A newsbrief of the collection

THE COMPUTER MUSEUM

The Computer Museum is the only institution of its kind in the world, chronicling the evolution of information processing from the abacus to the silicon chip through exhibitions, publications, historical research and programs.

It recently moved from Marlboro, Massachusetts to Museum Wharf in downtown Boston, where it will open this fall. The Museum's new location is minutes from Logan International Airport and just a short walk from Boston's financial district and such historic landmarks as Faneuil Hall and the Freedom Trail.

The Museum offers individual and corporate memberships for \$25 and \$125 per year respectively. Non-profit organizations may join at \$25 per year. Other membership categories are available for those seeking a higher level of participation. All members receive a free subscription to The Computer Museum Report, a 10% discount on merchandise from The Computer Museum Store, free admission and invitations to Museum events.

For more information, contact Jana Buchholz, Membership Coordinator at The Computer Museum, 300 Congress Street, Boston, MA 02210, (617) 426-2800.



THE COMPUTER MUSEUM REPORT (ISSN 0736-5438)

The Computer Museum Report is published quarterly by The Computer Museum, 300 Congress Street, Boston, MA 02210. A yearly subscription to The Computer Museum Report is free with membership. Individual issues can be purchased through The Computer Museum Store for \$3 apiece.

The Museum staff is responsible for the contents of the Report. The views expressed do not necessarily represent those of The Computer Museum or its Board of Directors.

Design and production of the Report is done by Benson and Clemons.

STAFF

Director

Dr. Gwen Bell

Administration

Geri Rogers, Coordinator
Margherita Ciampa

Business

Eva Radding, Coordinator

Communications

Stephanie Haack, Coordinator
Brenda Erie

Exhibits and Archives

Meredith Stelling, Coordinator
Dr. Oliver B.R. Strimpel, Visiting Curator
Beth Parkhurst, Research Fellow
Paul Ceruzzi, Research Associate
John McKenzie
Gregory Welch
Bill Wisheart

Membership

Jana Buchholz, Coordinator

Store

Lea Cohen, Coordinator

The Computer Museum
300 Congress Street
Boston, Massachusetts 02210

BOARD OF DIRECTORS

John William Poduska, Sr., Chairman
Apollo Computer, Inc.

C. Gordon Bell
Encore Computer Corporation

Dr. Gwen Bell
The Computer Museum

Erich Bloch
International Business Machines

Harvey D. Cragon
Texas Instruments

David Donaldson
Ropes and Gray

Robert Everett
The MITRE Corporation

Sydney Fernbach
Computer Consultant

C. Lester Hogan
Fairchild Camera and Instrument
Corporation

Theodore G. Johnson

Mitchell Kapur
Lotus Development Corporation

Dr. Koji Kobayashi
NEC Corporation

John Lacey
Control Data Corporation

Patrick J. McGovern
CW Communications, Inc.

James L. McKenney
Harvard Business School

George Michael
Lawrence Livermore Laboratories

Dr. Arthur P. Molella
The National Museum of American History

Kenneth H. Olsen
Digital Equipment Corporation

Brian Randell
University of Newcastle-upon-Tyne

Jean E. Sammet
International Business Machines

Edward A. Schwartz
Digital Equipment Corporation

Kitty Selfridge
Henco Software, Inc.

Erwin Tomash
Dataproducts

Photo Credits:

- The Hagley Museum and Library pp. 2, 4, 6
IBM Archives pp. 8, 10, 12, 14, 17
Phil Rosen pp. 7, 18
Meredith Stelling pp. 19, 20
Linda M. Watson (back cover)
Chris Kilby pp. 1, 19

The Director's Letter

As I sit and write this letter, carpenters are working in a gaping hole that will connect the two levels of the Museum with a stairwell. The Museum is between acts. Looking back six months, the memories of the fall programs in Marlboro are still fresh, while the staff's attention is focussed on the new exhibitions. This issue of the Report reflects the transition.

The major articles are versions of two outstanding programs from last year. Bob O. Evans, vice president of engineering, programming and technology at IBM presents an inside view of product development from meatgrinders to the IBM System/360. Then Bernard Gordon, president of Analogic reminisces about his second job, working for J. Presper Eckert at the Eckert-Mauchly Computer Corporation. Both of them breathe life into giant myths.

With the reopening months away, our concentration is focussed on planning new exhibitions. A half-inch scale model of the galleries filled with moveable machines, cases and people sits in the middle of the office space. It's a central gathering place where we test out ideas and give the rare visitor a "small scale" tour. When something doesn't fit or can't be explained, then it's modified. The model is rapidly filling with a variety of environmental, historical, operational and interactive exhibits. The major historical exhibit is a year by year timeline from 1950 to 1973 under the direction of Professor Paul Ceruzzi of Clemson University. The largest environmental exhibits are the AN/FSQ-7 and the SAGE installations being developed by Meredith Stelling of the exhibit staff. Working exhibits include printers and plotters and other devices that will operate on their own. Although the personal computer exhibit will have a concentration of interactive exhibits, every gallery will have visitor-generated programs that create understanding through hands-on experience. A number of college interns will be developing these interactive programs this summer.

The May 11th Pre-Preview Party provided an early deadline to get our stairwell and auditorium in place and to let us take advantage of the free space for both dining and dancing . . . activities that will be precluded by the full development of the exhibitions someday. It also kicked off the capital campaign described elsewhere in this issue.

This spring and summer, I'll be on the road visiting Minnesota, Washington state, California, New York, Europe and perhaps even Japan, spreading the message about our purpose as an international museum for the entire history of information processing. When the Museum reopens this fall, its exhibitions and programs should attract both national and international visitors when they're in Boston.

Gwen Bell

Bay 4 on floors five and six readied for a central staircase.



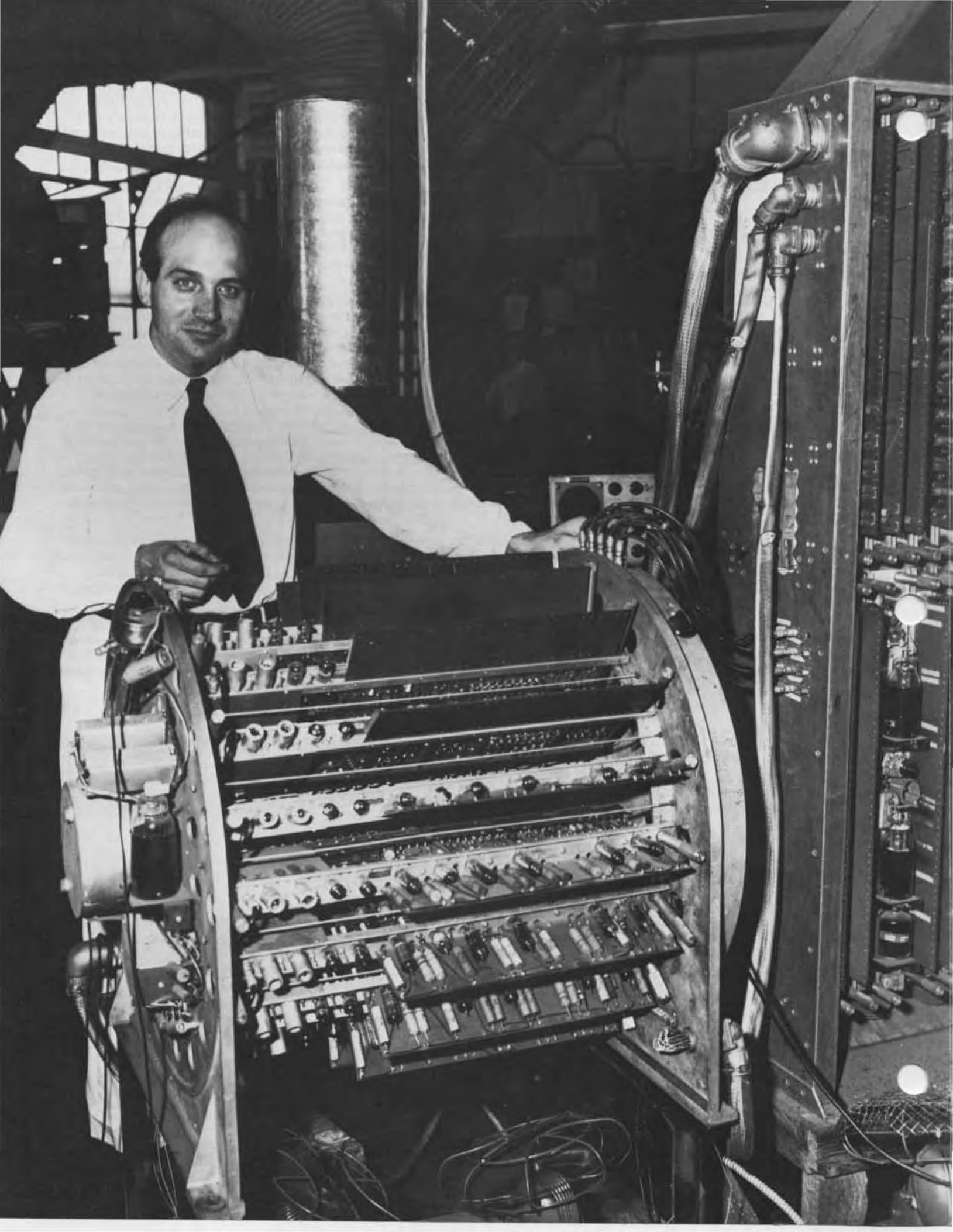

Computer Engineering Attitudes From Eckert-Mauchly to Analogic

Bernard Gordon

In 1948 Bernard Gordon graduated with a bachelor's and master's degree in electrical engineering from Massachusetts Institute of Technology (MIT). After starting with Philco Corporation, he joined the Eckert-Mauchly Computer Corporation. Today he is the president and technical director of Analogic Corporation which is engaged in the development and manufacture of high-precision, high-speed signal translation and information processing equipment. The following abbreviated and edited excerpts have been derived from a lecture presented by him at The Computer Museum on October 20, 1983. For historical purposes, the original presentation has been archived at the Museum on videotape.

About a year after I left MIT to start work at Philco Corporation, I received a call from Presper Eckert who told me I had been recommended by a professor at MIT and asked if I would come over for a job interview. Eckert, then about 28 years old, gave me such an intense technical and personal interview that even before he made me a job offer I told him I'd take the job just because he had motivated me to show him what I could do. He was so taken aback by this that, I guess, he felt he had to hire me and so he did.

Therefore, in 1948 on a hot summer day I reported to work at the Eckert-Mauchly Computer Corporation in Philadelphia in an old building near Wissahickon Park. One of my first memories is that of seeing Al Auerbach, now a long-time friend, standing literally in his underwear working in the middle of the heat of the circuitry which was supposed to become the BINAC, forerunner of the UNIVAC. As I recall most of the small group of engineers were nearly all in their twenties. The chief engineer was Jim Weiner who had come down from Raytheon. Jim ruled over us like a master sergeant and engendered in us reactionary passions . . . but he made us do our jobs. In later years I learned to bless him because he and Eckert inculcated in me, and I believe in the others who worked at the Eckert-Mauchly Computer Corporation, engineering disciplines which have served me well during the past 35 years.

It is interesting to note that Eckert-Mauchly had figured out that they would need about \$100,000 to engineer the UNIVAC and ready it for production. They had raised about this amount of money from the American Totalizator and had figured out this amount of money based literally on the number of solder joints in the machine and multiplying that by so many pennies. They therefore had predetermined the rate at which all of the work must be accomplished from logical design, the software, the electronic design, the construction, and the debugging.

Eight to ten engineers were to build, not knowing any better, all of the original circuitry for the UNIVAC and as well the first high-speed start-stop digital tape mechanisms, the

tape plating and manufacturing facilities for those tapes, the first-known card-to-tape converters, and the many other major sub-units of the UNIVAC system.

The machine was to have approximately 5,700 vacuum tubes, used primarily for amplification and pulse forming and 18,000 semiconductor diodes used primarily for high-speed gating. (It may be interesting to recall the semiconductor diodes utilized were purchased as war surplus materials from Western Electric.) When I arrived for work one of the engineers, Bob Shaw, had already essentially single-handedly drawn all of the detailed logic diagrams. I recall Eckert saying to me: "You are going to design the circuits, standard flip flops, standard gates, and so forth." He had allowed only a few working days to do this. I didn't know I couldn't do it, so I set out to do it. In a relatively short time, no more than a few weeks, we had designed and proven the capabilities of the standard gates; I then designed the I/O circuitry, supervisory control circuitry and tape control circuitry, standard flip flops and what we'd call pulse formers.

Eckert then set me to work to design the crystal transducer system for the acoustic memories of the UNIVAC and then all of the electronics for the memory system. The time allowed for each major design was always measured in days, not weeks or months. At that time I thought I was working on the world's first acoustic memories and it wasn't until a considerable time later that I found out that Maurice Wilkes, who is present at this lecture, had actually built a unit earlier in England. While I was carrying out this work together with the other engineers at the Eckert-Mauchly Computer Corporation, Pres Eckert and Jim Weiner taught me via their direction a number of factors about engineering and engineering supervision. I do recall that at the time we were receiving this type of direction we felt that they were very tough. But in the process of being apprentices to these master engineers, most of us went through a maturing and learning process which, in retrospect, I wouldn't have traded for anything. If in my later years I have myself developed a reputation for being a

J. Presper Eckert Jr.

tough engineering task master, I am pleased to say—and I hope that he will be pleased by my saying it—that Eckert was responsible.

For example, after Eckert more or less gave me a "gold star" for doing the acoustic memory, he put me in charge of a few other even younger engineers who were then being hired into the company. He gave me the following directive: "If you ever see an engineer studying during work hours, I want you to give him his first warning. If he does it a second time, terminate him." His view was, and it still remains mine today, that people owe it to themselves to further their career, to study at home, and that they should come to work prepared to get the physical work done.

The philosophy of "worst case design" probably originated, or at least was formalized, at the Eckert-Mauchly Computer Corporation. Eckert and Weiner insisted that when we design something, we must design it thoroughly, into the ground so to speak, and release our circuitry to production without ever breadboarding. In the first UNIVAC they established rules for derating such that every 25L6 vacuum tube must properly function in its circuitry with its emission dropping to approximately 50 percent with the screen voltage varying, with the heater voltages varying, with carbon resistors changing 20 percent, etc.

Although I didn't really prepare for this lecture in any formal way, as I stand here, I can remember the derating numbers of 35 years ago like a catechism. For example, every germanium diode which had a nominal back resistance of about a megohm with a back voltage of 30 volts had to continue to work satisfactorily if that back resistance went to 18,000 ohms. Every carbon resistor had to be able to change 20 percent and each power supply voltage had to change in the worst possible combination, about five percent. As a result, we were able to design with parts that really weren't very good and design equipment that could be predicted to work right essentially the first shot.

Eckert taught me to pay great attention to every detail. He taught me that the design engineer was responsible for every aspect of the design. The engineer should know how the components were made. What were their strengths and what were their weaknesses. There should be extreme tolerances on everything. He knew that only by doing this was it possible to make a machine with 5,700 vacuum

tubes each with a nominal emission life of about 5,000 hours work at all. However, by applying the rules of derating everything, it was possible to make a machine at that time which worked for acceptable periods of time.

At the end of every week, Eckert and Weiner would come around and we'd show them our big schematics with 40 to 100 vacuum tubes on them. He would look at a drawing, almost closing his eyes, and point to a resistor at random and say: "Why is that resistor that value? Why isn't it five percent higher? Why isn't it five percent lower? Show me in your notebook where you proved absolutely that that resistor is exactly the right value." I think I almost got fired one day because I had a grid resistor returned to ground, and he asked me why. I said that it was half way between plus and minus infinity, which was an unsatisfactory answer.

Every once in a while something humorous related to the disciplines that were put in effect would take place. For example, whenever the power came on the UNIVAC, a red light went on at the top of the machine's frame. Jim Weiner established the rule that whenever anybody made a mistake such as putting a screw driver or a scope probe in the wrong place and blew up a diode, he would have to buy a Coca-Cola for all the employees of the company, approximately 30. However, one day Jim Weiner himself put his screw driver into the wrong place and blew up all 18,000 diodes! It made us all feel much better. No one ever found out how he was able to blow them all up simultaneously, but he sure did.

I have always felt that Eckert conveyed a particularly important engineering philosophy to us. He felt, I believe, that any engineer worth his salt should be able to design anything at any time, either electrical or mechanical. If he didn't know how to do it, then it was his responsibility to go out and learn how to do it. I remember his saying to me: "When you go home tonight, your wife is going to want you to cut the grass. Don't do it. Hire somebody else to cut the grass who is a grass cutter, and you study and design for the company." He said: "This effort will come back to you many times in the future." I never did cut the grass and always felt as a result of his direction that it was my mother-in-law's job to take out the garbage and not mine! In any event, I have always spent continuously over the last 35 years two hours a day studying at home or at the MIT library or elsewhere . . . every day.



Al Auerbach and Jim Weiner (right), who according to Bernard Gordon, "established the rule that whenever anybody made a mistake such as putting a screwdriver or a scope probe in the wrong place and blew up a diode, he would have to buy a Coca-Cola for all of the company, approximately 30."



J. Presper Eckert Jr. is shown with a BINAC Mercury Memory Tank.

To engender his attitude, every once in a while Eckert would notify all the engineers that they would be given a written test. The test material generally had nothing to do with our then current work. The test material would touch upon a variety of subjects, such as the workings of an alternator or a power station or how to design a filter. If an engineer could not pass such a test, he was likely to be terminated. This, I believe, was Eckert's way of making sure that his engineers had a very broad interest and would be prepared intellectually to tackle anything that they had to. It was not unusual that one engineer such as myself would design wide band IF amplifiers one week and stainless steel tanks with crystal transducers for sonic mercury systems another week.

Eckert, through his personality and the fact that we were building the first commercial computer, got us very excited and interested in our work. Not only the theoretical and technical aspects but also the economic aspects. He used to get us to think in terms of how much everything cost, how much did the solder joint cost, how much did it cost to make a drawing, how much did it cost to have a secretary prepare a technical document, how many lines should a draftsman put on a piece of paper each day, etc.

To try to keep within his original \$100,000 budget, it was required at the Eckert-Mauchly Computer Corporation that every day one vacuum tube's worth of circuitry be released into production about every half hour by every engineer. There was no getting around it. Those were the standards set and that is what was expected. As I recall it was less than a year after the design started that the UNIVAC fully stood on the floor at the Eckert-Mauchly Computer Corporation complete with the first high-speed start-stop tape mechanisms, first acoustic memories, tape-to-card converters, ready to be system tested.

We probably didn't know it at that time, but nearly all of the engineers at the Eckert-Mauchly Computer Corporation were highly motivated by the atmosphere which I have briefly described. About the time of the completion of the UNIVAC I, the then Sperry Rand Corporation bought out the company and the culture began to change

"big time management" attitudes began to permeate the company. Many of the original engineers, including myself, then began to leave the company. Eckert, who had been my mentor, said to me when I left: "You may

never build another computer again, but it is probably true that everything you build in the future will in one way or another resemble a computer." He was right.

After Eckert-Mauchly

Eckert's prediction was proved on my next job. I moved back to Boston because the weather was too hot and muggy in Philadelphia. In Boston I worked for a company called Laboratory for Electronics, founded and populated with very famous names from MIT's radiation laboratory and who indeed had made major contributions to the series of well-known books entitled RADIATION LABORATORY SERIES. The company wanted to build a computer. But since the guys from MIT wanted the job, they were given the opportunity. I was assigned to work on the development of a doppler navigating radar. One day we realized that every half cycle of the doppler return signal represented the distance that the plane had traveled. So we thought that if we could count these half cycles, in turn we could build a digital doppler radar. Thus, consistent with Eckert's prediction, the doppler radar which would normally have been an all analog system ended up resembling a digital computer.

It was also on this job that I met An Wang who had just started his own company. He and I built a sequenced number generator which resulted in patents for wire core memories. We pulsed stacks of magnetic cores in sequence and read them out to generate arbitrary codes for controlling our rate multiplying navigational computer.

In 1953 I decided that it would be useful to tie computers together with analog signals and built a device called a DATRAC, the first known shift programmed successive approximation A/D converter. At that time together with another gentleman named Joe Davis, I started a company called EPSCO, Inc. and began hooking up analog to digital converters to computers . . . an activity I have been heavily involved in ever since. Today at Analogic we build a variety of measurement devices that compute, varying from very sophisticated phased-array ultrasound medical imaging machines to high-speed signal processing computers.

I have consciously and unconsciously tried to follow some of the principles that I originally learned in my younger days when I worked at the Eckert-Mauchly Computer Corporation. At Analogic we expect that proj-

ect engineers should personally be able to do the variety of tasks required on their projects. We rarely put more than three or four engineers on even the most complicated equipment that we design, such as the very first instant imaging CAT scanner or signal processing communications computers that make hundreds of millions of computations a second. Our project engineers who can be assigned from project type to project type are the keystones of our company.

Very often people from all around the world ask us: what do we at Analogic do that is different to get the engineering productivity and stability of our engineering staff. I always answer by saying: "We don't do anything different. You are doing things different. We are doing the same old things that we learned 30 or more years ago."

Let's briefly look at how things used to be and how they are today. In 1948 there were about 2,000 electronic engineers being graduated in the United States. Today with 250,000 electronic engineers nominally at work in our society and about 17,000 graduating each year, a hue and cry is heard across the nation that there is a shortage of engineers. What is wrong? In the 40's, engineers were taught, in addition to the type of disciplines that I have referred to, a breadth of mathematics and physics. They could be prepared to do anything because they'd been taught fundamental principles.

Recently I attended a seminar where a speaker stated that "the complexity of current projects is such that the mind of a single project engineer cannot encompass the breadth of the work." That fellow was talking about an engineering work station. Another fellow made a similar point about personal computers. Those of you who are in the audience who are about my age know that this is nonsense, because we were all called upon, when we were younger, to build and be totally responsible for much more complicated things. Certainly there is not a heck of a lot of real physical hardware engineering in any personal computer. Any good engineer could design a personal computer hardware-wise in a few weeks. The software would clearly take longer. But for the hardware, he needs to have an organizational concept utilizing available chips or have them laid out in gate arrays, buy a display and storage elements, and essentially "glue" it together. It would probably take longer to get the tooling for the plastic case than to actually

design the personal computer. Bear in mind that with Eckert's \$100,000 engineering goal (even if that translates to \$500,000 today) he intended to design from scratch the world's first commercial computer, the world's first card-to-tape converter, the world's first commercial acoustic memories, etc. Keep in mind that there was typically a half to one engineer working on each subsystem.

Now, let's look forward a couple or so years when you will probably be able to hold in the palm of your hand a 10 megaflop 32-bit high-speed computer with about a million bits of memory whose factory cost will be \$200 or \$300. When such building blocks are available, much of the "beauty" of this fellow's computer architecture or that fellow's computer architecture will fall by the wayside. The tasks for computer-related systems will be more and more related to being able to harness that computing power and design and build useful real-world machines encompassing a breadth of technology.

Now, what has happened to engineers? I would like to state my opinions and I am aware that not everyone will agree. In most companies the attitudes of Pres Eckert or Jim Weiner are no longer taught nor is the mentor relationship available to most young engineers. It is very rare for a youngster out of school to go to work for a 28 year old truly experienced engineer. He is liable to go to work for another youngster who has only been out of school for two years, who in turn has worked for a youngster with a similar limited level of experience.

I believe that with about five percent supervision by a broadly experienced motivating engineer, less experienced engineers can increase their productivity somewhere between two and three times. At Analogic we jokingly call this "Gordon's Rule" and are certain that the theoretical parameter of improvement is "e" or 2.7183.

Now, some people such as the people developing work stations claim that by the appropriate use of engineering work stations it should be possible to increase engineering productivity by 4 to 1. Possibly they are right and possibly Gordon's Rule is right. Of course, if they are both right, then it must be possible to achieve a ten-fold increase in engineering productivity. If this is so, you would think that this combination would easily solve the engineering shortage!

However, in my opinion the reality is that the true problem is that there is a grave shortage of engineers whose



Eckert-Mauchly Computer Corporation, Engineering Group, 1949. Row 1: Fran Morello, Bob Shaw, Pres Eckert, Brad Shepard, Frazer Welsh, John Mauchly, Jim Weiner, Al Auerbach, Betty Snyder; Row 2: John Sims, Marv Jacoby, Paul Winsor, Gerry Smoliar,

Art Gehring, Betty Jay, Ed Blumenthal, Bob Mock, Jean Bartik, Herman Lukoff, Bernie Gordon, Ned Schreine; Row 3: George Gingrich, Marv Gottlieb, Lou Wilson, Doug Wendell, Charlie Michaels, Ben Stad, Si Levitt, Larry Jones.



BINAC Laboratory tables, May 12, 1949.

education and orientation gives them a very broad view. Recently I became concerned about the breadth of capability of many software engineers. The following may be instructive. When Eckert interviewed me in 1948, I had learned a great deal about "pole and zero-based transfer functions" by working at Philco. When I had to design an IF amplifier for the UNIVAC, I was able to achieve an overall transfer function by matching the effective poles of the transducers to an optimum complementary transfer function of the amplifier. Recently I started playing with my little home computer and just to exercise myself decided to write a program for an arbitrary number of poles and zeros to calculate the phase and amplitude transfer functions and the transient response. Having once known how to do this very well mathematically and particularly knowing the graphical interpretation of pole zero relationships, it took me only a few hours to achieve the result I desired. The next morning upon arrival at Analogic I asked one of our relatively new but previously experienced software engineers how long it would take him. His answer was six months! At first I was startled, but as I proceeded to talk to him, I discovered that he could probably write the program in two hours also . . . if he knew something about poles and zero mathematics . . . but that he felt it would take him five months 29 days and six hours to learn about poles and zeros! Then he could write the program.

We can all recount examples of projects where hardware engineers, software engineers, marketing people or customers could not interact effectively because they did not understand each other's needs. It is my belief that in the 36 years since I went to work for Eckert, I have witnessed a continual decline in the average productivity of engineers. Let's take a measure of it. Only 25 years ago it was common to say that there should be a development engineer for every million dollars worth of electronic production in the United States. Now, 25 years later, with an inflation factor of at least four and with the availability of CAD/CAM techniques, LSI and VLSI and all the other modern wonders, a computation of the total electronic output in the United States divided by the number of electronic engineers at work yields a value of only about a half a million dollars. This combined factor of eight is of great economic significance. It should cause most business managers and technical leaders to pause and

give consideration to whether they have allowed the standards of engineering excellence and productivity to decline in their own organizations.

Question and Answer Period

Q: Did Eckert ever really fire someone for failing one of his tests?

A: Yes.

Q: How could you keep working if you thought your job was on the line?

A: I'm not suggesting that somebody should be fired because they don't know something, but if they won't learn something, that is different. Not too long ago I fired a mechanical engineer who would not draw. He said that he thought up designs "in his head" and he would then translate his thoughts to a draftsman . . . and that it was beneath his dignity to draw. We found that he really *couldn't* draw and didn't want to learn. He had a degree in mechanical engineering . . . but had never taken a drafting course!! He's not atypical.

Q: What was the role of John Mauchly?

A: I believe that Mauchly was the original driving force behind the ENIAC. He was a professor at the University of Pennsylvania, and Eckert was a graduate student. They founded the Eckert-Mauchly Computer Corporation. At the time I was employed, Mauchly was somewhat less active for reasons, as I recall, that were very personal.

Q: Was there a strict hierarchy and structure?

A: Although Jim Weiner was the chief engineer, Eckert would often jump up to the top of a filing cabinet and sit on it and squat. He would take on the characteristics of a guru to anyone that was around at the time. As I recall there really wasn't a pecking order at all. He used to have what I thought was a wonderful idea of saying to people, "Say anything that comes to your mind. Idea. Idea. Idea. You have 99 inadequate ideas and maybe the 100th will be invaluable." Eckert would always engender an atmosphere where people would not be afraid to be wrong about anything. We all had a lot to learn and to conceive.

Note: Recently the Massachusetts Board of Regents has authorized the formation of a new institute to be called The Gordon Institute, a school of engineering leadership to be located in Wakefield, Massachusetts. Its aim will be, consistent with Eckert's philosophy, to teach engineers a

breadth of knowledge involving technology, ethics, and philosophy, considered to be musts for true leaders and to develop an orientation toward the successful economic accomplishment of projects undertaken.

October 20, 1983



Gordon and Wilkes. Bernard Gordon (left) president of Analogic Corporation is greeted by EDSAC designer Maurice Wilkes after Gordon's lecture on "Computer Engineering Attitudes From Eckert-Mauchly To Analogic" at The Computer Museum on October 20, 1983.



IBM System/360

Rob O. Evans

Bob O. Evans is IBM vice president, engineering, programming and technology. He joined IBM in 1951 as a junior engineer in Poughkeepsie, New York, where he took part in the development of IBM's first large scale computers. After various assignments in computer development, he was promoted in 1962 to vice president, development, for the Data Systems Division which included overall management responsibility for development of IBM System/360. The following article is based on a lecture presented by him at The Computer Museum on November 10, 1983. For historical purposes, the original presentation has been archived at the Museum on videotape.

The System/360 and its direct descendants have accounted for more than a hundred billion dollars worth of revenue and considerable profit for IBM and has been the foundation of our basic business for years longer than we anticipated. I wish to tell you something of the environment, actions and people who made System/360 happen.

IBM was formed in 1911. At that time it was called the Computing, Tabulating and Recording Company and was an amalgamation of three tiny companies that worked on products such as meat slicers, scales and nurse call systems. One part of the small firm was the Tabulating Machine Company that had been built upon the intellect of Herman Hollerith, inventor of the punched card. This little company, recording a few tens of thousands of dollars of revenue, grew slowly in those days. By the early 1930's, CTR had grown and, amazingly, had shed itself of most of the prior products, the nurse call system, the scoreboards and the meat slicers, concentrating upon the Hollerith concept to become an electric accounting machine company.

Several factors accounted for CTR's success: first, the strength of the Hollerith concept itself; second, the young leader who ran the company, Thomas J. Watson, who had come from the National Cash Register Company; and, third, the U. S. Social Security Act of 1931, which created an enormous demand for the types of machines CTR built.

The Computing, Tabulating and Recording Company's name was changed to International Business Machines in 1924. In 1930 IBM's revenue was \$19 million a year and then grew by 1939 to \$38 million a year. A more important measure of the effectiveness of the company is net earnings after tax—which were 36.8 percent in 1930. Of course the tax structure in those days was substantially different. Nonetheless in net: IBM was a healthy small company, producing electric accounting machines for a growing demand.

By 1949 IBM had grown to be a \$200 million a year business that primarily leased electric accounting machines. The view within was that IBM was the product leader in electric accounting machines; it was a profitable institu-

tion and investors loved IBM. If you had bought a few dollar's worth of stock then, you would not have to work now. IBM had very strong user loyalty, and most importantly, there were abundant opportunities for new electric accounting machines.

Let us examine IBM in the decade of the 40's in more detail. There was a revenue bulge that came during the war years as the company—like all U.S. industries—turned to the national effort. Then there was some downturn as the company recaptured its breath after the war to return to its basic business direction. Profit was 20 percent of earnings in 1939 and by 1949 profit had grown to \$33 million or 18 percent net after tax.

In the national interest work during the war years IBM produced fire control systems and navigation and bombing systems among other products. From this IBM's Military Products Division grew, and was later renamed the Federal Systems Division, although the revenue of that division is today a small percentage of IBM's total.

New events led IBM to turn another radical corner. One often wonders how these things happen and, on reflection, the change was most unusual, for here was IBM doing well with electric accounting machines when the Korean war started. Shortly after the war broke out, Mr. Watson sent a telegram to President Truman offering IBM resources for the national effort. The consequence of this telegram was that two IBM executives surveyed the National Laboratories and other national interest work around the United States to determine what IBM might do. One was an engineer named Ralph Palmer, in my viewpoint one of the geniuses that IBM was fortunate to attract, who established the foundation of the IBM development community as it still exists today. The other was a master salesman, Dr. Cuthbert Hurd. Dr. Hurd and Mr. Palmer, under the aegis of the Watson telegram to the President, toured the U.S. They visited such places as Livermore, Los Alamos, National Security Agency and aerospace companies to determine how IBM might contribute. When they returned they told Mr. Watson the best thing IBM could do was build a high-speed computer much like the high-speed com-

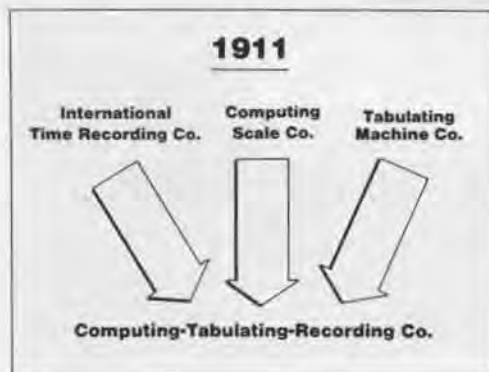

Evolution of CTR, the Company that Became IBM.

puter that Dr. John von Neumann was building at the Institute for Advanced Study and Professor Maurice Wilkes was building at Cambridge University. They concluded there was great need for such computer power in national interest areas and that IBM should do it.

The government was not all that interested, so Mr. Watson, anxious to keep his pledge, decided that IBM would fund the effort, thus in 1950, the project began.

A principal viewpoint then in IBM was that such a project was an intrusion on the mainstream. The estimated demand for such electronic systems was ten or so and the prices were certain to be astronomical. Thus the view was the project was indeed a sacrifice, but IBM should get on with it and then get back to our basic EAM (electronic accounting machines) business as swiftly as possible.

The project was called the Defense Calculator and was formally named the IBM 701 Electronic Data Processing Machine. The first system was installed at IBM's World Headquarters in New York City in December 1952. I was lucky to be one of the engineers who went to New York City to get that system installed and operating. Nineteen 701's were built between 1952 and 1954. The rental for the system was a staggering \$20 thousand a month at a time when other IBM machines rented for \$300 a month or so. Thus, the 701 did not seem to have much promise. Fortunately, Mr. Watson's son, Tom Watson, Jr., saw the potential of electronics. He had become President of the company and pressed for more effort in electronic computers. You can imagine the reaction of some senior management. They knew the accounting machine business, they loved it and there were long lists of new EAM features and equipment needed to meet customer requirements. Thus many pressed to continue focusing on EAM. But Tom Watson, Jr. led the business into electronics.

In the 1952 and 1956 era of vacuum tube technology, a number of computers came from IBM. The business computers were characterized by being alphanumeric, handling both alphabet and numbers, and operating serially by character on those voluminous strings of variable character length data. Business systems also had more extensive peripherals, usually tape drives, card machines and printers. In contrast to the business systems were scientific systems such as the IBM 701, which were parallel, binary and had more limited peripherals.



IBM 701 Electronic Data Processing Machine, 1952.



IBM 704, 1955.

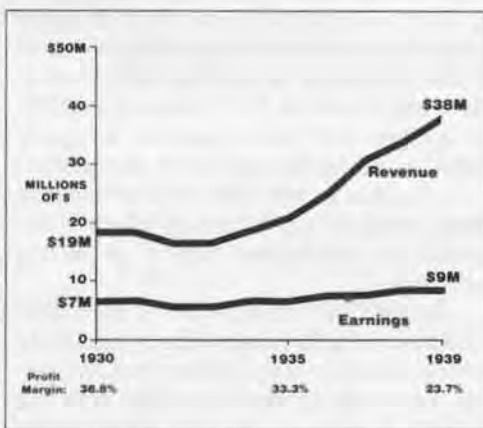

IBM Growth: 1930-1939.

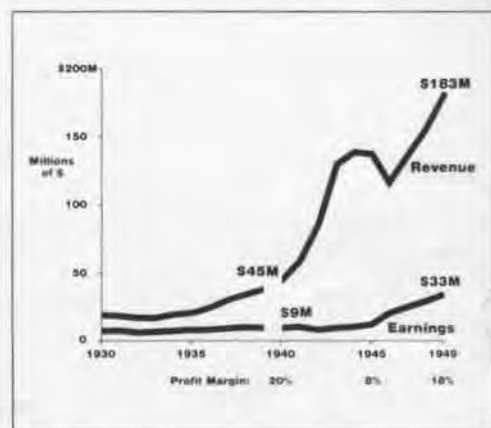

IBM Growth: 1940-1949.

In a short time an improved version of the 701 was produced called the IBM 704. Gene Amdahl had come to IBM from the University of Wisconsin, where, as his doctoral thesis he built a machine called the WISC. He, John Hoff, and a small group worked on the architecture of what became the 704 with new innovations such as floating point, indexing, and other bright new functions. Later core memory replaced the old Williams tube memories and, still later, the IBM 709 evolved from the 704 base. In that era another business computer was produced, the IBM 650, centering about a magnetic drum storage device. More than a thousand 650 computers were sold, far more than the forecast.

The 305 RAMAC was a new system conceived by Ralph Palmer, IBM's engineering genius. He wanted to see business data immediately accessible to the processors and he envisioned a disk device. Palmer set up a laboratory, IBM's third, in San Jose, California, to develop disk products. The 305 RAMAC became the first disk system that IBM produced. The sales forecast was for four or five thousand although fewer were sold.

Also on the business systems side, several hundred 702 and 705 systems were produced. They rented for more than \$30,000 a month, taking the place of a lot of sorters, collators, gang punches and calculators that were then the mainstream of IBM's business. Some 250 704's and 709's were sold to scientific users.

These big rental, big ticket items brought in a lot of revenue to IBM in that exciting period. So Tom Watson, Jr.'s hunch about electronics proved correct and IBM was on its way into a new era.

How did the business do? Through the decade of the 30's and the 40's the company grew to \$200 million. Now we see the consequences of the shift to

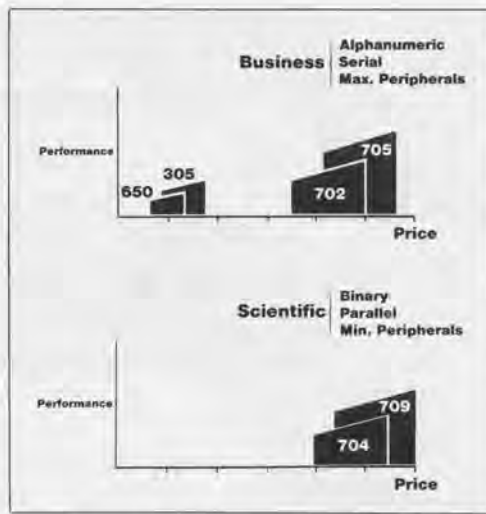

IBM Vacuum Tube Computer Families: 1952-1956.

electronics for, in the decade of the 50's, IBM grew swiftly to approximately a billion dollars in 1957, and in the following two years to \$1.6 billion, fueled by our movement into electronics.

Some companies working on the early computers were ahead of IBM, and I would have to say that IBM was able to succeed so well because of our marvelous sales force and outstanding service which were the keys to IBM's ability to grow from a small company to the very significant company we became in the 1950's.

Profit margin for that period was somewhat reduced as heavy investments were going into electronics. After tax margin declined to 10.9 percent, still healthy by most measures.

Then we entered the transistor age. IBM announced its first semiconductor system in 1957 and delivered it in 1958. Through the period of 1959 and 1960, IBM brought out a number of systems, some with new architectures and some with evolved architectures based on their vacuum tube predecessors.

For example, the 7080 was a semiconductor version of the 702 and 705 business systems. It was brought out because the new architecture 7070 business system had not done as well as had been expected. Customers that had 702's and 705's were not converting their programs to the radically different architecture of the 7070, thus the compatible 7080 was produced. Less than 100 of the 7080's were produced, yet the system was a business success.

A special story, however, was the 7070 which was IBM's new business architecture entry for the semiconductor age. RCA had produced their vacuum tube BISMAC series and then moved to their transistorized 501 series. The 501 had good performance and price, and IBM was racing to com-

pete before we lost initiative in the business systems area as business applications were viewed as being 80 or 85 percent of the demand in those days while scientific applications provided the rest. Thus the 7070 was a new era system that we hoped would retain IBM's position and allow us to grow from that base.

Ralph Palmer had done something that was typical of him: he held a competition to determine which laboratory was going to design the 7070. Poughkeepsie, IBM's large systems laboratory, had a design that was attractive and they vied for the responsibility of building IBM's new transistorized business entry, essentially the plum of the development community.

The Endicott laboratory, which had earlier produced the 650 system, had its own version of what to do: they proposed to build upon the 650 architecture and Endicott worked hard to win the prize. When the dust settled, Endicott had won the mission with a lot of aggressiveness in proposing features and function in what was to become the 7070. It turned out, however, the 7070 was such a complex system that it did not sell as well as had been expected.

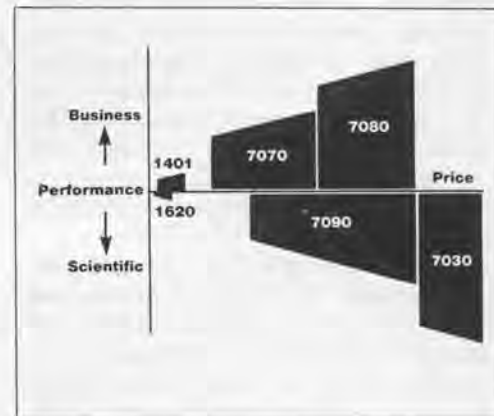

Dawning of Transistor Age for IBM Computers: 1957-1960.

In the meantime, in Endicott there was work on replacing electric accounting machines with stored program computers. IBM had been struggling for seven years to find a way to consolidate in an electronic system the capabilities that were found in the assorted unit record machines such as gang punches, collators, sorters and calculators. Several approaches had failed because the people working on the designs had tried to build systems with plug boards which were the control unit in the electric accounting machines.

A bright engineer in the Endicott laboratory, Fran Underwood, con-

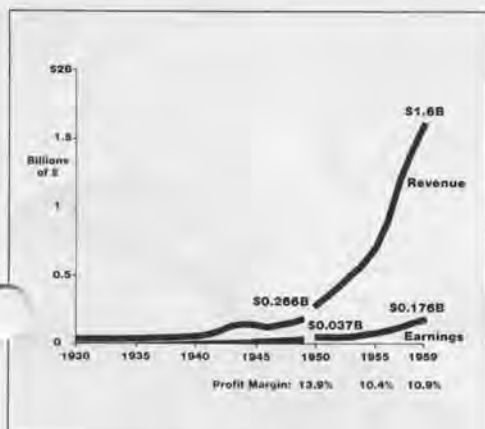

IBM Growth: 1950-1959.

ceived a von Neumann stored program system that became the IBM 1401. That system, announced in 1957 and shipped first in 1958, went on to become, from IBM's standpoint, the Model T of the computer industry. It rented at \$2495, an unprecedented bargain in contrast to the \$20, \$30, \$40 and \$50 thousand per month that customers were paying to rent the bigger systems of the times. We expected to sell 5000 1401's but eventually installed more than 12,000. The 1401 led IBM into the computing big time, bringing to the company a much broader set of systems customers.

On the scientific side, the 7090 was a transistorized version of the 704 and 709, just like the 7080 was a transistorized version of its vacuum tube predecessor. Something like 300 7090's machines were installed. They were profitable and were very popular in the scientific and aerospace communities and that had something to do with some of the arguments that arose during System/360's design.

There had been a gap in the middle of IBM's scientific product line and a lot of clamor came from the demanding sales force for small scientific computers. A group at Poughkeepsie developed a machine called the 1620. However, instead of a small binary design they produced a decimal design. Its rental was \$1600 making it the first IBM system with a rental price smaller than its serial number. We sold more than a thousand of those systems to the fledgling minicomputer area.

The 7030 was a special machine. Years earlier, Dr. Edward Teller had wanted a new scientific system for three-dimensional hydrodynamic calculations, and Dr. Teller talked about his need to IBM super salesman Cuthbert Hurd. Dr. Hurd had guessed that such a system might take a couple of years to build, might cost \$2.5 million and might run at one or two million instructions per second. Dr. Teller went to Congress and got the funds. And so a small group that included John Griffith and Gene Amdahl, worked on a design that we called LARC for Livermore Automatic Reaction Calculator. A Univac team also worked on their version of LARC. We thought we had a great design and were on the way out the door of the Poughkeepsie laboratory to present our design to Dr. Teller when Ralph Palmer stopped us and said, "It's a mistake." Transistor technology was changing rapidly, and we were going to build this system with point contact transistors or surface



IBM 305 RAMAC, 1950's.



IBM 7090, 1958.



IBM 1401, 1958.

barrier transistors, the semiconductors that produced the best speed in the early days. Palmer had noticed the newly invented diffusion process promised better control of the speed of semiconductors and thought it would be a mistake to build the LARC system with obsolete semiconductors and occupy the estimated 350 people required to build it. So Palmer, to our dismay, forced us to tell Livermore's Lou Nofrey and Dr. Edward Teller that we had decided not to build the design we had worked on. We showed Livermore our design approach to illustrate the kind of system we were capable of building but said, "We are not going to build that machine for you; we want to build something better! We do not know precisely what it will take but we think it will be another million dollars and another year, and we do not know how fast it will run but we would like to shoot for ten million instructions per second." So Dr. Teller bought the Univac machine, and we went back to lick our wounds.

Later, with the Univac LARC system commencing development for the AEC and the able Sperry salesmen selling it, IBM concluded that we had better fund a new system ourselves. The thesis was to build the fastest system. It was internally called Project Stretch, for stretching the technology. We did design the Stretch system ultimately producing a total of seven. Its IBM type number was the 7030 and it was the fastest system in the world for a period. The 7030 was quite expensive to build, costing IBM tens of millions of dollars. However the technology and the architecture that flowed from Stretch later had important influences. All of us in the IBM development community have a soft spot in our hearts for taking on such "one-of-a-kind, break-the-sound-barrier" projects.

It would be relevant to describe the company organization in the 1950's when IBM was still very small. Although it was a \$200 million firm, there was one vice president for engineering and he handled all engineering business such as the national interest business, supplies, typewriters and electric accounting machines, the largest engineering activity and, the few engineering tasks in electronic computers. And so it was with manufacturing with one VP overseeing all projects and so it was with marketing that a VP oversaw both sales and service. That was an inappropriate structure for the growing IBM which crossed a billion dollars of sales in 1957, thus the organization was changed. A

major reorganization started in 1955 and in four years the change was completed. In essence, the company decentralized and formed new divisions.

The World Trade Corporation, that had started years earlier was beginning to grow. It had its own marketing for the countries in which IBM was present, its own service, its own manufacturing and its own development with its own laboratories and engineers. World Trade had rationalized their countries needed products that were different from what the Americans were producing, so it set out to build its own products for its customers.

In the mainstream was a senior vice president for data processing, T. Vincent Learson. His organization was set up in a new structure consisting of three divisions. The General Products Division in Endicott, New York and San Jose, California had the mission of developing and manufacturing products with rentals up to \$10,000 per month. In Poughkeepsie, New York the mission of the Data Systems Division was the development and manufacture of systems renting above \$10,000 per month. The Data Processing Division handled sales and service and was headed by a super professional, Gilbert E. Jones. In its heyday it was as fine a marketing force as ever existed.

One important point: In this structure the financial books were controlled by the product divisions; marketing and service were run on apportionments that were doled out by the product divisions. Thus the product divisions did the market forecast; set prices and had general responsibility for the financial health of the products they produced.

Now let us consider the IBM product offerings at the time System/360 development was commencing. There we were in 1960 with six families of new systems, most of them doing well. The 7070 was not selling as well as we had hoped but the rest were selling well and some, such as the 1401, far exceeding our forecasts.

The major reorganization had just been completed in 1959 when Tom Watson, Jr. called the new senior management together and, in what I thought was real vision, said that our new products should serve IBM well but we should start thinking about where we are going in the future and should have someone start working on that future. His conclusion was the Data Systems Division would be given that mission.

Now some irony: the General Products Division, which had won the inter-

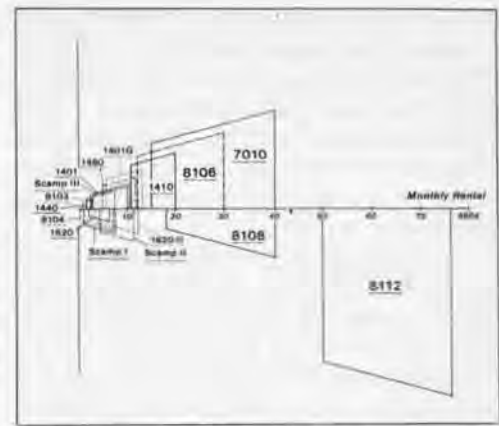

IBM's Overlapping Product Line: 1961.

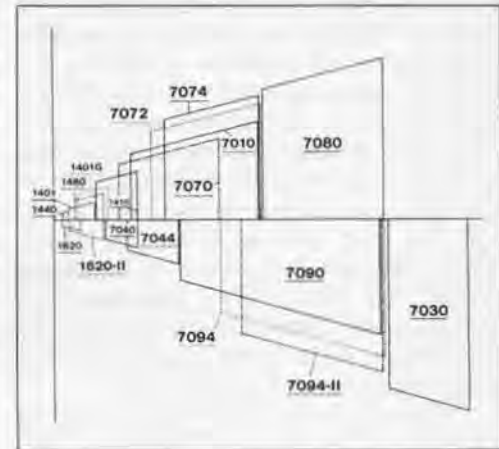

IBM's Immediate Products to Strengthen the Product Line: 1961-1963.

nal competition to build the 7070 was struggling with that system's design and release to manufacturing. It was late in schedule and its architectural complexity was affecting programming.

However in the major reorganization of the 1950's as luck would have it, the Data Systems Division took over responsibility for the 7070 and its problems. Some of DSD's leaders thought the best thing to do was to get rid of 7070 so they started a project in Poughkeepsie to build a better system. The development leader in Poughkeepsie, Steven Dunwell, gave a simple charge to the engineers under him: "I want a machine that is twice as fast as the 7070, at half the cost." He had another little codicil on his charge: he wanted it packaged in one rollagon, which was one of the packages we used then in larger systems.

So the people in Poughkeepsie began the new design. Bolstered by Tom Watson's assignment of a corporate mission to plan the next series, they expanded their 7070 replacement into a family called the 8000 series.

The proposed 8106 was the specific product Poughkeepsie conceived to replace the 7070, and it was furthest

along. As a matter of fact, it was being prepared for announcement in March 1961. To fulfill their worldwide mission, Poughkeepsie quickly planned other systems around the 8106. They added a scientific attachment called the 8108; it was not a standalone machine—you had to buy an 8106.

Burroughs was working on a technique called push down stacks and Polish notation and that concept enamored some of our people. Thus Poughkeepsie decided to build an analogous high performance system called the 8112. The General Products group was so successful with the 1401 that they did not want anything to do with the 8000 series but Poughkeepsie required small systems to handle peripheral management and to provide growth for their bigger systems. Therefore, they wanted a small commercial machine and started a design called the 8103, a small business computer. To fill the gap in the scientific area, Poughkeepsie proposed a machine called the 8104. These systems had some architectural similarities but, by and large, were quite dissimilar and that was perhaps the fatal flaw.

Other groups in IBM were working away too. The General Products Division, with their 1401 success, had planned to take that machine in all directions, down and up. They proposed a 1401G, 1440, 1410 and 7010. They had a 1620 model II, and because of the success of the 1401 and 1620's it appeared that General Products was headed for success with a line of systems competing with Data Systems' proposed 8000 series.

The World Trade Corporation did not like the 1620, it was a decimal machine and World Trade wanted a small binary machine. Thus the Hursley, England Laboratory started a design of a 48-bit, small binary machine called SCAMP-I, a credible machine that might have succeeded had it proceeded. Unhappily, the computer demand in Europe in those days could not generate enough volume to pay SCAMP's way, so the machine was in financial trouble. The aggressive Hursley Laboratory then said, "We can build a faster version called SCAMP-II on the SCAMP-I base, get more volume and fix the business case." They tried just that but it was not enough to fix the business case. So, undaunted, they hypothesized a business version of SCAMP called SCAMP-III, and were evaluating that approach.

In net then, World Trade had its evolutionary plan, Data Systems had the corporate mission and its 8000 se-

ries plans and General Products had its plans based on the success of the 1620 and the 1401. All the camps were in competition. It appeared as if a time would come when a customer would call up and say, "I would like to hear about an IBM machine," and three salesmen would get stuck in the door waving their catalogues saying, "Don't listen to him, listen to me."

My role in this came in January 1961 when Vin Learson asked me to leave Endicott, where I was working on the 1401, 1620 and the 1410, and to go over to Endicott's rivals in Poughkeepsie. His instructions were simple: "Look at that 8000 series—if it is right, build it; if it is not right, build what is right." That is about the length of the discussion I had with Learson.

One of the problems we had with all those architecturally dissimilar systems, was that peripherals had to be customized by family. If you wanted to build a peripheral that was optimized for parallel binary machines, that was tough to justify business-wise. If you were going to build something that was serial by character for commercial machine, that was another design. None of these systems had enough volume to sustain new investment in a variety of types of peripherals, so the peripheral groups in San Jose, Endicott and Poughkeepsie worked at what they believed best to build, and the system adapted those devices to the processors.

Since most of the technology work was going into the processors the peripherals were not keeping pace with the processors. It was possible to go from one processor to another and get 100 percent gain in internal performance, but because of slow peripherals a user might realize only a 10 or 15 percent gain in thruput performance and that is before you take programming into account.

Circuit technology was also different by type of machine. Here I must say that Ralph Palmer and senior development management had strived to standardize our semiconductors from the beginning. Previously in IBM every project had its own designers who would design the circuits for their projects, optimizing their products for their intended applications. In 1955 Ralph Palmer established central circuit-design laboratories, with the centralized group providing circuits to the systems groups. It caused much disagreement in the laboratories but, in hindsight, it was the right decision.

To aid standardization we designed a printed circuit card called

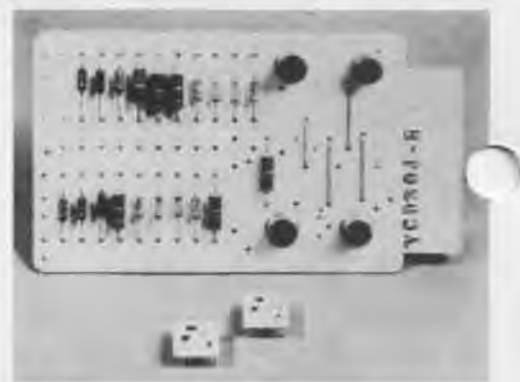

Two COMPAC Modules (bottom), Equivalent to the Standard Modular System Card (top); 1961.

SMS—the Standard Modular System. One card was approximately the size of your hand and held one circuit of discrete transistors, resistors, diodes and capacitors. We developed a lot of automated equipment to insert components, to solder them in place and to test the cards. In the early days of transistors and the Standard Modular System, the management theory was that if we did it right, about a hundred of these SMS card types would serve all the IBM systems which would be just fine for service, service training, engineering refinement and further evolution.

However by 1960, the requirement had exploded out of control and had grown to more than 2500 card types. The Standard Modular System plan had missed its target significantly. There were so many card types the circuit engineering force spent its time designing new circuits. And, of course, field inventory, field engineer training, and such things were expensive and complex.

Perhaps the worst problem that plagued our many types of systems was programming. In 1960, during the heyday of the 1600 and the 7000 series, our programming budget was \$5 million, less than five percent of the development budget. With so many types

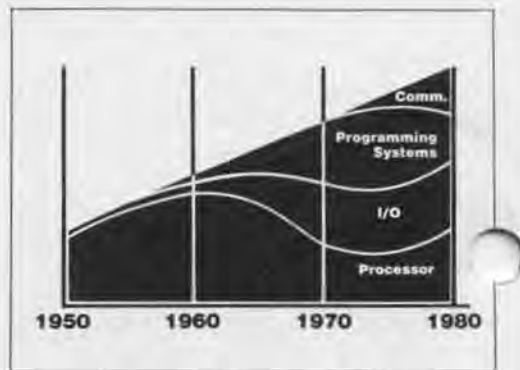

IBM Development Resources: 1970-1980.

of architectures, not only did we have to produce FORTRAN for each type of architecture but there had to be a FORTRAN for the disk version of the 7090, and one for the tape version of the 7090, as well as special assemblers and utilities. We were in trouble with respect to programming in 1960 and we knew it.

Moreover, we had split our customers' computing with scientific and business machines. Boeing is a typical example. It had two very able yet separate computing shops—one had 7080's, one had 7090's—vying for funds, vying for applications and vying for people. What really was happening, we perceived, was that business systems needed more of the logical and computing abilities of the scientific systems, and the scientific operations needed more of the variable field length and alphanumeric capabilities of the business systems. We had unwittingly put our customers into two camps and the camps were competing.

The user programming investment was high and growing rapidly, and our customers had sent us a signal with the 7070: no matter how powerful the architecture, no matter how much better the price-performance ratio was in contrast to older systems, they were not going to make the move. Most users could not afford to convert and did not.

In 1960 most IBM development resources went into the evolution and propagation of processors. Only a small amount went into peripheral research and enhancements. Most peripheral R&D went into tapes, a bit into disks and printers, and a tiny amount—\$5 million in 1960—for programming.

Thus, with all these problems, in considering the 8000 series in 1960, we concluded it had frailties such as the incompatibilities between the architectures themselves, had other missing elements in the program and were planning implementation in existing technology. In May 1961, a decision was made to build a new family of systems in new technology. Each system in the family would be equally adaptable to business and scientific use. And while it was easy to produce machines that were upward compatible, we were going to try and design the new systems to be both upward and downward compatible. Thus if any systems had the required peripherals and the amount of memory specified by the programming, it could run the same programs, whether it was a big machine or a small one. More importantly, the approach unfettered

programming from the specific systems themselves. The entry-level programming could run on the whole family, and large systems programming—more complex programming with higher function—could also run on the whole family.

And to fix the I/O problem, the new systems' thesis was standard interfaces for peripherals. We decided to have the peripheral devices adapt to the standard interfaces so that control programming would not have to be changed extraordinarily by new peripherals, and we hoped the new peripherals could achieve high volumes.

Lastly, the plan was to build the new systems in a new technology that was under development in IBM. Internally it was called the Compact technology, later named SLT—Solid Logic Technology. Basically, it was a hybrid, micro-miniaturized technology which, instead of using the palm-sized SMS card to package the circuits, Compact used fingernail-sized chips, each containing a single circuit. Erich Bloch, John Gibson and I agonized a lot in 1961 about whether we should go to large-scale integration instead of pursuing the hybrid micro-miniaturized technology. Fortunately, we elected to build what we had in hand. Heavy investment went into automating the production of SLT technology and production was very sophisticated. Significant volumes were turned out at high quality and low cost.

The architecture of the systems had a decimal and variable field length base structure with optional binary and floating point. Each system could perform scientific as well as business calculations and we also tried to design in the basics needed to allow us to expand to new applications such as real time or event driven applications as they unfolded.

Another problem: IBM has an aggressive sales force and they were paid largely on commissions. Our salespersons did receive a base amount which would buy baloney sandwiches, but if they wanted to eat steak, they had to sell. Our sales force's long range viewpoint was that "tomorrow is too long." They certainly had a tough time waiting for a few months, let alone a few years. However, anything as significant as shifting gears to a new technology, new architecture and new programming was going to take a lot of time. We estimated that we would announce in 1964. It turns out we did announce in 1964 and shipped in 1965. But in 1961, such a delay seemed like an eternity to the sales force.

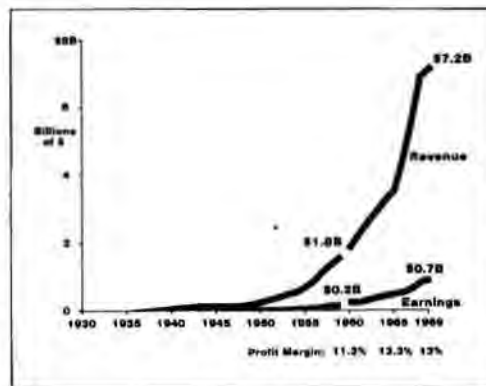

IBM Growth: 1960-1969.

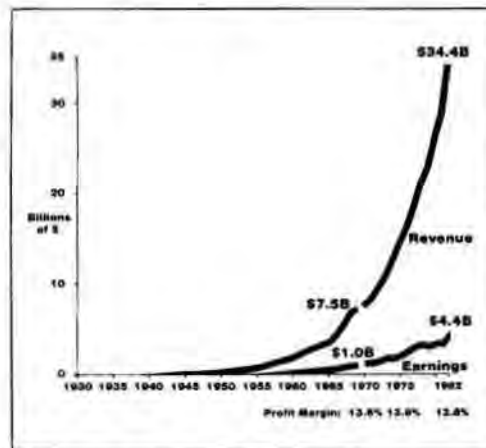

IBM Growth: 1970-1982.

In the meantime Seymour Cray at CDC and lots of able companies were beginning to succeed, bringing out competitors for the IBM product lines. Our sales force felt their homes were burning down and they wanted some solutions quickly. So we put in place some programs I called "temporizers"; I hate the word, but that is what we called them then. The project consisted of extensions to the current product lines. There was to be a higher speed version of the 7090, called the 7094, which turned out to be so successful that we built a 7094-2 and we actually worked on a 7094-3. Two new extensions of the 7070 were built—the 7072 and the 7074—intended to aid the lagging 7070 sales.

A bigger version of the 1410 was built for 1401 growth, the 7010. A 1620 Model 2 was built, and for that gap in the small scientific area, two systems were built that were related to the 7090 architecture—the 7040 and 7044.

All these systems were undertaken starting in mid-1961. Some were announced in 1962 and the rest by May of 1963. IBM suffered competitive losses but we were able to keep the sales force alive during the time the gears were being shifted to System/360.

In net: System/360 solutions in terms of the problem was to stan-

standardize peripheral interfaces across the system; the circuit technology used throughout the system was the new solid-logic technology; programming was independent of the hardware, and the scientific and business split was solved by integrating into one system the capability of addressing both classes.

The key issue of 1962-63 became one of program conversion. For a long time Fred Brooks, Gene Amdahl, John Griffith and others worked on how to do this. The first thought was to have machine translation. Bright people worked on a conversion program that would allow one to dump a program in a hopper and have the conversion produced run effectively on the new architecture System/360. After a couple of years of hard work and several million dollars of investment, we concluded automatic conversion was not going to make it. The theory then was that we had better back off to machine-assisted translation where we would translate as much as we could and signal the items that had to be handled manually.

We knew our customers were not going to convert manually; we had to have a tool. Necessity breeds invention, and a couple of professionals found the solution. We found that if we examined the 1401's registers and data flow in the light of the 360, the 360 had all the registers and more, and all the data paths and more. Since we had decided to use some of Professor Wilkes' work in the controls of these machines, namely read-only memory instead of hard-wired logic, the controls were vastly simplified. Thus it was relatively easy to add to a 360 machine the instruction set for a 1401 and literally throw a switch so the System/360 would run credibly as a 1401. Emulation proved out for the 1401, 7070, 7090, and 7080—fortunately for IBM.

Systems running in emulation mode did not run at full 360 performance, of course. But, by and large, through the combination of read-only memories for control that let us add the instruction repertoires of the older machines, the 360 machines did take on the form of the older systems and customers could run the old machines' programs with reasonable price-performance and then convert at their leisure to the newer architecture when they wanted. But believe it or not, some users are still running in emulation mode after all these years.

1962 was a period in which we found ourselves asking can we make

it? Can we design the family? For a while it appeared that we could not design a processor that was inexpensive enough at the low end while containing the instructions of the big machines; similarly for a processor at the high end, would their performance be limited by staying compatible?

But senior management realized that if we produced a five-times 1401 and Honeywell produced a four-times 1401, the whole question would be quickly reduced to plant capacity. Honeywell might sell 5000, we might sell 5000, and conceivably there would be a price war. Worse, the 1401, invented years earlier, was inadequate for future applications.

In contrast to the existing product lines, there were so many attributes in the new product family that in February 1964 IBM decided to go ahead. We announced System/360 on April 7, 1964. We announced five machines; the Model 30 was developed in Endicott and the Model 40 was developed in Hursley, England. As a side point, World Trade wanted to play a role in the 360 development. Its labs were full of bright people, but young and inexperienced, thus I wanted to give them supporting roles. However, Vin Learson said "Absolutely not. They have to have a head-held-high role; we want to give them a whole system." So we did. We exported a number of U. S. people to help Hursley, and after that Hursley became one of the senior labs in IBM's development community.

Poughkeepsie developed the Models 50, 60 and 62, and Model 70.

Later, through the last part of the 1960's, there were successors and additions announced: the entry System 20 and the 22, the 25, and a scientific optimization Model 44. Some new memory came into the 65, which replaced the 60 and the 62, and the 75 with the new memories replaced the 70.

The 360 model 67 grew out of MIT's criticism of System/360. MIT scientists were important in computer research, and we wanted to be certain we stayed close to MIT's thinking. And during this period, as busy as we were, 360 design people would go occasionally to MIT. However, in retrospect, MIT did not hear us, we did not hear them, and I presume we did not speak clearly enough to them.

When the 360 system was announced on April 7, we all settled down to the happy task of making it happen. But on June 6, 1964, I traveled to MIT to see what they thought of 360, which by then had been announced for a couple of months. To my dismay, Professors

Corbato and Fano told me that they did not like System/360.

Three of MIT's four criticisms were trivial and could have been fixed quickly but, criticism one was deep in the concrete and that was MIT's view that time sharing was just around the corner, thus dynamic address translation would be a fundamental part of any system's architecture in the future. Without it, management of the storage by the programmers would be an impossibility.

There was some debate in IBM, but I decided that MIT was right, and we had missed it. It took us several years, but we did fix it and finally got dynamic address translation across the family. However, back in 1965-66, we produced a special version of the Model 65 called the Model 67 which was built for leading-edge customers like Bell Labs that wanted time sharing and demanded dynamic address translation.

Unhappily for us, MIT decided to buy a General Electric machine and not the 67 that we were designing to supplement the 360 family and answer their requirements. Through the 1960's, the only 360 machine that had dynamic address translation was the Model 67. A special version of that design, called the 9020, became the system used in the FAA's enroute traffic control system.

We thought in those days we would be lucky if the series would last one generation—3, 4 or 5 years—and if we were really lucky it would last 8 or 10 years. However System/360 has lasted 20 years, and we are working now to extend its life into the 90's. Possibly it will not make it, but the durability of the 360 architecture has far surpassed our expectations.

By the late 1960's, technology had marched on to the point that instead of one circuit per solid logic chip, we could do three or four circuits per chip: the early days of large-scale integration. So we produced a family of follow on 360 systems: the 115, 125, 138, 148, 158 and 168 and, in between, there is some detail of what were called "vanilla" machines that I will skip. The bottom line is that all these machines had dynamic address translation and our control programming was substantially evolved to accommodate virtual systems capability.

The mid-range and high-performance systems of the 1970's were direct members of the 360 architecture family. And since 1979 the 43XX machines and the 308X's were added and they are all members of the 360 architecture. These systems, over the years,



IBM System/360.

have produced more than \$100 billion of revenue. IBM margin has stayed strong even through the thick and thin of such periods such as the recessions of 1971 and 1975.

I said earlier that we tried to design into the roots of System/360 the abilities that would let us work in future applications. One that we sensed clearly in 1962 and '63 was teleprocessing, for it was beginning during that period. But we did not get our hands enough around teleprocessing to know just what to do, so we put hooks into System/360 to add teleprocessing capabilities later.

Our estimate was that in the United States we would sell 2500 of the 40, 50, 60 and 70 systems, and by 1970 a third of those would have remote terminals and thus require communications, hardware and programming. What actually happened, fortunately for IBM, was that we sold twice as many of those systems as we had expected by 1970, and by 1968 we had already passed in teleprocessing what we had expected to reach by the end of 1970. And by 1970, we had sold two and a half times what we had expected to sell in terms of teleprocessing.

In hindsight, just building those 360 machines and the complexities of the technology, new peripherals and control programming so consumed our resources that we really did not tend swiftly enough to communications. And that explains the alphabet soup that existed in 1970 teleprocessing for one laboratory or another would develop a piece and a customer would produce something else and the assemblage was inadequate and inconsistent for teleprocessing in 1970.

Thus, starting in the early 1970's, we set out to do the same thing to the communications subsystem that we had done to the central processing subsystem. It was called Systems Network Architecture (SNA), and some of you may be familiar with SNA. We shipped SNA first in 1974 and, it has been generally accepted by the International Standards Organization as an architecture that straightens out the protocols, disciplines and structures of the communications subsystem.

In 1973, when we were finishing work on SNA, our hope was that we might install 3500 SNA systems worldwide early in the 80's. Last year an IBM team gathered to celebrate our 10,000th SNA customer.

At present in the hey-day of PC's and the exploding world of work stations, we are talking in terms of

hundreds of thousands of SNA installations.

SNA has had a succession of sophisticated additions to the structure, the features you would expect once a base is in place; alternate routing in the case of line outages, dynamic re-configuration non-IBM terminal attachment, and those types of abilities.

There is an explosion taking place in computers and communications. Today we find computers connected to computers by communication lines and control units connected by communication lines to hundreds and thousands of terminals. Then, of course, there are minicomputers pioneered by Digital. Whether it is real-time applications, batch applications or interactive applications, minicomputers also require communications from distant terminals, and more and more, these terminals need access to central data bases and vice versa. Thus there is great need for computer communications.

If I would characterize where we are today in allocating our resources, we spend a good deal more on communications and still spend a hand-

some amount on programming and peripherals.

The computer-communications explosion caused us to decide to do something more significant in communications.

We worried about AT&T for, if they controlled all communications and also provided computers, IBM might be at a disadvantage. Thus we invested in a communications satellite company that is providing new communication services. It will be a good business in its own right and is bringing new communication capabilities to teleprocessing users, keeping pressure on the telephone companies. We think that is good for the industry.

How did general management operate? First there was a strategically minded management in the 1960's. Tom Watson assigned a team to work on the next generation.

A broad direction was set but the senior management delegated detail; they did not strive to manage the architecture. They heard the debates and worked to resolve problems but never stepped in to dictate designs such as 36-bit words.

The 360 undertaking stressed IBM to the limits and senior management organized and reorganized IBM to meet the needs of the times.

Lastly, I must say that through a lot of countering viewpoints, senior management such as Tom Watson, V. Learson and Al Williams, had a lot of tenacity and did risk a lot.

As to whether it was worth it, I will just say that from the period 1964 to 1980, the profit after tax on 360 systems was far greater than the total sales we had anticipated back in 1964. This System/360 was an outstanding business success. More importantly, it gave us the foundation to move resources into new peripherals, to do the things like SNA and all that went with SNA in terminals and teleprocessing, to specialize in certain industry areas and to diversify into businesses such as satellites.

It has also given us a new complexity for in the 1960's came the compatible peripheral competitors. A small company in Oklahoma, Telex, started making copies of IBM's magnetic tape. A number of customers bought the copies. And soon, manufacturers produced copies of our disks, multiplexers and main memory and by the 1970's we saw copies of our terminals and finally, the piece de resistance, compatible central processor from Fujitsu, Hitachi, Amdahl, Magnusson and others.

Those copies were expected. When we started to work on System/360 our rationalization was that, in the face of copies we had to insure that IBM was constantly the best, that we had the best technology and the best programming and the best price performance. Those ideas sold in IBM and we still believe it.

One negative consequence was the anti-trust litigation that was very costly and stressful.

In the last days of Lyndon Johnson's administration a law suit was filed by the Department of Justice. Also, Telex had filed suit saying that we had damaged them with our "predatory" practices. We filed against Telex for stealing and in a curious decision in 1972, the District Court in Tulsa found for both companies. It found Telex guilty of stealing and fined them \$20 million and found us guilty of damaging Telex and fined us \$120 million. After trebling under U.S. antitrust law that fine went to \$360 million.

At the end of 1972 IBM stock went from \$365 to \$140.



Evans viewing the Whirlwind. Museum board member Gordon Bell (left) points out the Whirlwind computer exhibit to IBM vice president Bob O. Evans at the Museum's former site in Marlboro, Massachusetts. Designed in 1951, the Whirlwind was the first real-time, parallel-processing computer with core memory.

Museum News



Office Preparations. Before the staff arrives from Marlboro, workers ready the newly renovated office space at Museum Wharf.



Moving in. Almac movers slide a word processing system into the new offices at Museum Wharf on moving day, March 7th.



The last load. An Almac moving truck arrives at Museum Wharf in downtown Boston March 7th to deliver the second and final truckload of office furniture and equipment.

\$10 Million Capital Campaign Kicked Off with Pre-Preview Party

A gala pre-preview party at The Computer Museum's new home in downtown Boston kicked off its \$10 million capital campaign May 11th. The evening opened with a lecture by Intel founder Robert Noyce followed by dinner, dancing and films.

The capital campaign is designed to raise the \$10 million needed to purchase half interest in Museum Wharf, create new exhibits, and start an en-

dowment. It will establish the Museum in its new quarters and provide a foundation for its continued growth.

A new brochure outlining the campaign asks potential donors to "invest in the future of The Computer Museum." Suggested levels of giving start at 4K (\$4,096) and continue in the standard industry memory units of 8K, 16K, 32K, 64K . . . 256K.

Individuals and corporations from

throughout the industry and Museum members will be asked to participate in the campaign.

For more information on the campaign, contact: Gwen Bell, Director, The Computer Museum, 300 Congress Street, Boston, MA 02210.



Under wraps. This is not a trendy new exhibit, but Museum artifacts upon arrival at Museum Wharf.

Museum to Host Engelman Lectures on Artificial Intelligence

Judith A. Clapp

A provocative new lecture series on artificial intelligence (AI) in honor of AI pioneer Carl Engelman begins at The Computer Museum this fall.

For more than 20 years, Carl Engelman and other researchers in industry and academia have worked on creating intelligent computer systems.

Engelman's contributions to the field are among the major successes that have occurred since the inception of artificial intelligence. He developed MATHLAB, one of the first systems to perform symbolic mathematics in the mid-1960's. He headed a group of researchers at the MITRE Corporation in development and application of expert systems, techniques for computers to understand English, and research in the automatic generation of computer software.

Only a few "intelligent" computer systems are commercially available to

date, but the interest in AI is greater than ever. In the United States, the Defense Advanced Research Projects Agency spends some \$50 million a year on AI research. In Japan, the Ministry of International Trade and Industry is spending \$450 million in a 10-year project to develop a Fifth Generation computer particularly suited to AI applications.

The Computer Museum's lecture series will trace how the fundamental approaches to artificial intelligence have been developed, show how they have been successfully applied, and explain why there are so many challenges remaining.

If you share an interest in artificial intelligence or would like to make a contribution in Engelman's memory, please send your donation to Engelman Lectures, The Computer Museum, 300 Congress Street, Boston, MA 02210.

July

The Computer Museum and Graphics Pioneers will co-sponsor a panel session entitled "A Retrospective: Six Perennial Issues in Computer Graphics" at SIGGRAPH '84 on July 25th in Minneapolis, Minnesota. Museum director Gwen Bell, Atari chief scientist Alan Kay and others will trace the evolution of the technology and the major issues in the field.

September

Members will receive the fall issue of The Computer Museum Report featuring a complete fall calendar of events and a transcript of Robert Noyce's Museum lecture on his invention of the integrated circuit. The new 1984-85 Museum Store catalog will also be off press and on its way to members.

November

An opening party for Museum members is planned for Tuesday evening November 13th. The Museum will open to the public on Wednesday November 14th.

Join the Museum

Name _____
Address _____
City/Town _____
State _____ Zip _____

Please enter a membership in the following category:

Member	\$25
Corporate Member	\$125
Founder	\$250
Corporate Founder	\$2500

All members receive the quarterly Museum Report, a 10% discount on Museum Store purchases, and announcements of Museum programs and events. All membership contributions are tax-deductible within the limits provided by law.

To become a Member or Founder fill out this coupon and return it with your check or money order to:

Membership Coordinator
The Computer Museum
300 Congress Street
Boston, MA 02210

New Founders

(January 24 through April 24, 1984)

Applied Magnetics Corp.
AvX Corporation
John C. Barstow
Alan G. Bell
Gregory C.F. Bettice
Marshall D. Butler
Thomas W. Crosby, Jr.
Joe Cychosz
Bob O. Evans
Tse-yun Feng
J. Thomas Franklin, Esq.
Regina H. Garb
Charles W. Johnson
M. Kapor/E. Poss
Bryan S. Kocher
Jim McIntosh
James N. O'Boyle, Jr.
James F. Shaughnessy, Jr.
The Small Business Foundation
Rex Rice

Corporate Founder List

(January 24 through April 24, 1984)

Almac Moving and Storage, Inc.
American Federation of Information
Processing Societies, Inc.
Apollo Computer, Inc.
Association for Computing Machinery
Automatic Data Processing, Inc.
Benton and Bowles
Bolt, Beranek and Newman
Boris Color Labs
British Computer Society
Robert Cipriani Associates
Clint Clemens
Codenoll Technology Corporation
Computer Science Press
ComputerWorld
Control Data Corporation
Convergent Technologies
Coopers and Lybrand, Boston
Data General
Dataproducts Corporation
Digital Equipment Corporation
Digital Equipment Computer Users Society
Expoconsul International, Inc.
Ford Motor Company
Fujitsu Limited
General Systems Group, Inc.
GTE Data Services, Inc.
Hewlett Packard Company Foundation
IEEE Computer Society
Intel Corporation
International Telephone & Telegraph Corporation
Los Alamos National Laboratory
MDB Systems, Inc.
Microsystems Engineering Corporation
MITRE Corporation
MOCO, Inc.
Motorola, Inc.
National Semiconductor Corporation
OMNI Publications International, Ltd.
PCK Technology Division
Richard Reno
Schlumberger Foundation
Seldin Publishing
Software Results Corporation
System Development Foundation
Tobin Vending Service
The Travelers
Wang Laboratories

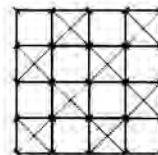

What is a Founder?

Any individual or corporation who gives more than \$250 or \$2500 respectively during the Museum's first two years.

On March 14, 1982, The Computer Museum was given provisional status until June 24, 1984 by the IRS as a public, non-profit charitable foundation. During this time, the Museum has to prove that it is indeed a widely supported public institution.

With almost 500 Founders at present, the Museum's goal is to close the book on June 24th with 1,000.

This is a unique opportunity to establish the only international museum devoted exclusively to computers and the history of information processing. If you are a Founder, we thank you, and if not, urge you to become one.

A newsbrief of the collection

The MITS Altair 8800 was introduced in 1975 as a low-cost mini-computer available either assembled (\$621) or in kit form (\$439). Designed around the Intel 8080 microprocessor, the Altair was marketed as the processor for an extensive system of products, ranging from line printers to TV-camera inputs. Because few of these peripherals were ever developed, the Altair became a hobbyist's computer.

It was the first computer to use a cassette tape as auxiliary memory; the information was recorded acoustically as modem tones. The Altair was also the first computer to offer BASIC on the Intel 8080 processor. "The Altair's success is really based upon Intel's quality," former Altair salesman Rick Jevon related in a gallery talk at the Museum in September 1982. Nonetheless, according to Geoff Feldman, another early Altair salesman, "It required a tremendous amount of very creative twiddling to make it work."

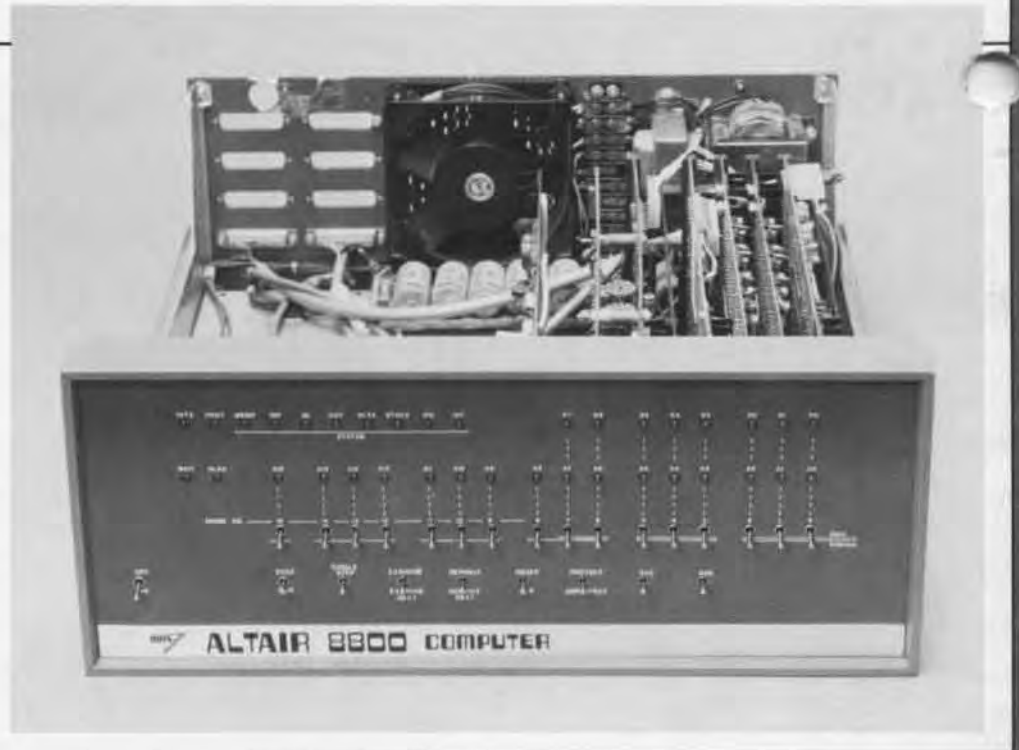

The Computer Museum

300 Congress Street
Boston, MA 02210

Non-Profit
Organization
U.S. Postage
PAID
Permit No. 110
Fitchburg, MA
01420

THE COMPUTER MUSEUM REPORT

NUMBER 10



FALL 1984

Individual Founders □ Charles W. Adams □ Ken R. Adcock □ David Ahl □ John Alexanderson □ Kendall Allphin □ Gene M. Amdahl □ Michael and Merry Andelman □ Harlan E. & Lois Anderson □ Applied Magnetics Corp. □ Mr. & Mrs. Rolland B. Arndt □ Dr. John Atanasoff □ Isaac L. Auerbach □ AVX Corporation □ Charles and Constance Bachman □ Jean-Loup Baer □ Robert W. Bailey, Ph.D. □ John Banning □ Jeremy Barker □ Steve F. Barnebey □ Harut Barsamian □ John C. Barstow □ Jordan and Rhoda Baruch □ Gordon & Barbara Beeton □ G. C. Belden, Jr. □ C. Gordon & Gwen Bell □ James and Roberta Bell □ Chester Bell □ Alan G. Bell □ J. Weldon Bellville □ Dr. Leo L. Beranek □ Roger & Kay Berger □ Jeffrey Bernstein □ Alfred M. Bertocchi □ Gregory C. F. Bettice □ Lamar C. Bevil, Jr. □ Bitstream, Inc. □ Erich & Renee Bloch □ David R. Block □ Elizabeth Boiger □ Ted Bonn □ Allen H. Brady □ John G. Brainerd □ David H. Brandin □ Daniel S. Bricklin □ Richard A. Brockelman □ David A. Brown □ Gordon S. Brown □ Lawrence C. Brown □ Arthur and Alice Burks □ James R. Burley □ Max Burnet □ Jim & Margaret Butler □ Marshall D. Butler □ Roger C. Cady □ Philip and Betsey Caldwell □ Walter M. Carlson □ Charles T. & Virginia G. Casale □ George A. Chamberlain III □ George A. Champagne □ Alan Chinnock □ Donald Christiansen □ Peter Christy and Carol Peters □ Dr. Donald D. Clark □ John D. Clarke □ Richard J. Clayton □ Reginald & Linore Cleveland □ George Towne Clifford □ Harold Cohen □ William H. Congleton □ Charles W. Conn □ Fernando J. Corbato □ Harvey Cragon □ Jim Crapuchettes □ Thomas W. Crosby, Jr. □ Henry J. Crouse □ James G. Cudmore □ Karen R. Cunningham □ Kent K. Curtis □ David N. Cutler □ Joe Cychoz □ Thomas A. D'Auria □ Randall Davis □ Clive B. Dawson □ F. de Bros □ Ed de Castro □ Jean E. de Valpine □ Mr. Arnaud de Vitry □ Nick de Wolf □ Amos R. L. Deacon, Jr. □ Harvey and Barbara Deitel □ Gregory Del Sesto □ Bruce A. and Frances M. Delagi □ William R. Demmer □ Jack Dennis □ Michael L. Dertouzos □ David DeWan □ Peter DeWolf □ Richard Dickerman □ Lloyd I. Dickman □ John diTargiani □ L. John Doerr □ Henri G. Doll □ James R. Donaldson □ David Donaldson □ Patrick M. Donini □ Georgedna Doriot □ Philip H. Dorn □ A.S. Douglas □ Doug Drane □ J. Alvin Dru'yor □ Greg Duckworth □ Ray Duncan □ Sanford H. Duryee □ Joseph J. Eachus □ Richard Eckhouse □ Professor David B. Edwards □ Tom Eggers □ M. Gordon Ehrlich □ Dan L. Eisner □ Dean Elsner □ Lucian J. Endicott Jr. □ John H. Esbin □ Richard & Stephen Etzi □ Bob O. Evans □ Robert R. Everett □ Ulf and Helene Fagerquist □ Andrew R. Farber □ David J. and GG Farber □ Robert A. Farmer □ Edward A. Feigenbaum □ Andrew D. Feit □ Geoffrey Feldman & Sharon Lipp □ Tse-yun Feng □ Sidney Fernbach □ Edward Alvin Feustel □ Mark S. Fineman □ Read T. Fleming □ Mary Jane Forbes □ Professor Jay W. Forrester □ Philip E. Fox □ J. Thomas Franklin, Esq. □ Clark Frazier □ Ed Fredkin □ Peter Freeman □ Neil Freeman □ Alan E. Frisbie □ Henry Fuchs □ Samuel H. Fuller □ Lorrin Gale □ Bernard A. Galler □ Regina H. Garb □ Willard H. Gardner □ Donald A. Gaubatz □ Donald H. George □ Branko J. Gerovac □ Bruce Gilchrist □ Mrs. Donald B. Gillies □ John T. Gilmore Jr. □ Rose Ann Giordano □ Robert Glorioso □ Philip Goemmel □ Robert Goldman □ Steve Golson □ David Goodman □ Bernard M. Gordon □ Arthur W. Gottmann, MD □ Roger S. Gourd □ J. M. Shag Graetz □ John Griffith □ Sheila Grinell □ Herbert R. J. Grosch □ Stephen Gross □ Marie and Brian Gruzinov-Henderson □ Dr. Roberto A. Guatelli □ Richard H. Gumpertz □ Karl M. Guttag □ Jerrier A. Haddad □ W. M. Hall □ Lewis H. Halprin □ William R. Hambrecht □ J. Scott Hamilton □ Sheryl Handler □ Alain Hanover □ Richard M. Haskins □ Ardoth A. Hassler & James M. Short □ Michael Hathaway □ Frank E. Heart □ William Heffner □ Andreas Herberger □ Margaret A. Herrick □ Richard W. Hill □ Winston R. Hindle, Jr. □ Peter S. Hirshberg □ Robert B. Hoffman □ C. Lester Hogan □ Commodore Grace M. Hopper, USNR □ Christoph Horstmann □ M. Ernest Huber □ A. L. C. Humphreys □ Bill Hunzeker □ Professor Harry Huskey □ Richard I. Hustvedt □ Robert A. Iannucci □ Inforonics, Inc. □ Aron K. & Merle S. Insinga □ International Market Resources □ L. R. Jasper □ Alan Jeddelloh □ Michael Jerabek □ Howard W. Johnson □ Theodore G. and Ruth T. Johnson □ Charles W. Johnson □ Nolan T. Jones □ Lehman M. Jones □ John Allen Jones □ David W. Juers □ M. Kapur □ E. Poss □ Paul A. Karger □ Bill Keating □ Francis W. Keller □ Allan Kent □ Christopher Kent □ Jack S. Kilby □ Lawrence J. Kilgallen □ Kirk □ Martin Kirkpatrick □ Daniel Klein □ David C. Knoll □ Andrew C. Knowles, III □ Bryan S. Kocher □ Dr. Robert B. Kolstad □ Dr. Benn Konsynski □ David J. A. Koogler □ Mary Jo Kostya □ Alan Kotok □ Marian J. Kowalski □ Edward A. Kramer □ Stanley Kugell □ Laura Lein and Benjamin Kuipers □ Kaneyuki Kurokawa □ Robert L. Kusik □ John Lacey □ Robert Laman □ Hal Lamster □ R. L. Lane □ Glen G. Langdon Jr. □ Robert Langridge □ Bert W. Larey □ Richard Lary □ Duncan H. Lawrie □ Prof. Harold W. Lawson, Jr. □ John Laynor □ Les Lazar □ John Levine □ Michael Levitt □ Henry M. Levy □ John V. Levy □ T. G. Lewis □ Robert C. Lieberman □ Richard Lindquist □ Steven B. Lipner □ Joyce Currie Little □ C. L. & Jane W. S. Liu □ Theodore C. M. Lo, M.D. □ William H. Long □ Carl D. Lowenstein □ William F. Luebbert □ Arthur Luehrmann □ Edward P. Luwish □ Carl Machover □ Ian MacLennan □ Tsugio Makimoto □ Dave Mallery □ Franklin N. Mann □ Julius L. Marcus □ Tom Marill □ Robert F. Marsh □ Richard O. Mason □ Andrew H. Mason □ Robert H. Matthews □ Ruth Maulucci □ Robert Mayer, Jr. □ Lou Mazzucchelli □ Tron McConnell □ Pamela McCorduck □ Daniel D. McCracken □ F. Warren McFarlan □ Henry McGilton □ Hugh McGinness □ Patrick J. McGovern □ Jim McIntosh □ Thomas McIntyre □ James L. McKenney □ John McKenzie □ William and Vesta McLean □ John E. McNamara □ George C. McQuilken □ Thomas and Elizabeth McWilliams □ Carver A. Mead □ R.W. Meister □ Robert M. Metcalfe □ Matthew Miao □ Donald and Jean Michie □ Harold T. Miller □ Robert C. Miller □ William F. Miller □ Richard G. Mills □ Charles R. Minter □ Reg S. Mitchell □ Robert Moe □ Thomas H. Moog □ Gordon E. Moore □ Morgan-Grampian Pub. □ Frank E. Morris □ John Morrissey □ Dr. J. Craig Mudge □ Albert E. Mullin, Jr. □ Saburo Muroga □ David Murphy □ Dan Murray □ Dr. & Mrs. Isaac R. Nassi □ Susannah and Nigel Nathan □ Lee J. Neal □ Gregory L. Nelson □ David & Pat Nelson □ Stewart Nelson □ Joseph Nestor □ Bill Newcomer □ Joseph M. Newcomer □ Chuck Newman □ Reade B. Nimick, Jr. □ Walter I. Nissen, Jr. □ C. Landon Noll □ Bernard J. Nordmann □ Jeremy M. Norman □ Norton Company □ Bill Noyce and Jonie LaBombard □ Bob Noyce □ H. Edward Nyce □ James N. O'Boyle, Jr. □ Martin J. O'Donnell □ Anthony G. Oettinger □ Lawrence & Pauline Oliva □ Kenneth Olsen □ Adam Osborne □ Robert K. Otnes □ John Ousterhout □ Louis Padulo □ Paul Pangaro □ Ted C. Park □ Kenneth D. Patterson □ James V./Martha M. Patton □ Edward G. Perkins □ Jean-Claude Peterschmitt □ John Peterson □ Nicholas A. Pettinella □ Linda J. Phillips □ Gerard Piel □ Juan A. Pineda □ James A. Pitts □ Andrew Plescia □ Bill & Susan Poduska □ Michael D. Poe □ J. Eric Pollack □ William G. Pomeroy □ Trevor J. Porter □ James N. Porter □ Jonathan Postel □ Kenneth F. Powell □ Robert M. Price □ Robert W. Puffer III □ Robert E. Ramsdell □ Henry W. Ramsey □ Professor Brian Randell □ Dr. Robert W. Rector □ Brian and Loretta Reid □ Nicholas Reinhardt □ Audrey R. Reith □ Paul Repacholi □ Ronald Resch □ Rex Rice □ Fontaine K. Richardson □ J. E. Richardson □ William D. Ricker □ C. Mike Riggall □ Mark L. Robinson □ Ann and Robert Roc-Hafer □ David and Linda Rodgers □ Peter R. Rony □ Michael Rooney □ Dan Rose □ Jack Roseman □ Robert F. Rosin □ Martin S. Roth □ Dorothy E. Rowe □ Thomas S. Roy, II □ Richard Rubinstein □ Dr. & Mrs. Charles R. Rupp □ Stephen Russell □ Martin I. Sack □ Michael J. Samek □ Jean E. Sammet □ Peter R. Samson □ F. Grant Saviers □ Robert L. Schapp, Jr. □ Rebecca Schatz □ Andrew Schmidt □ Edward A. Schwartz □ Earl & Mary Schweppe □ Andrew Scott □ Aaron Seidman □ Mr. and Mrs. Oliver G. Selfridge □ Donald G. Seydel □ James F. Shaughnessy, Jr. □ W. Lee Shevel □ John J. Shields III □ John F. Shoch □ Alan F. Shugart □ Marc Shulman □ Dan Siewiorek □ Thomas W. Simons □ Richard B. Sims □ Jonathan Singer □ Norwood Sisson □ Richard L. Sites □ The Small Business Foundation □ Dr. Ronald G. Smart □ Daniel P. B. Smith □ John F. Smith □ Steven Spellman □ Donald D. Spencer □ Robert Spinrad □ John T. Stapleton □ John T. Stark □ Gerald Steinback □ Max J. Steinmann □ Seth Stern □ William M. Steul □ Jack H. Stevens □ David K. Stevenson □ Robert E. & Diane M. Stewart □ Dr. George Stibitz □ J. Michael Storie □ William D. & Carole K. Strecker □ Thomas A. Susic □ Howard Sussman □ Ivan and Marcia Sutherland □ Erick N. Swenson □ Dr. Stephen A. Szygenda □ David Tarabar □ John Tarar □ Robert W. Taylor □ Norman H. Taylor □ John V. Terrey □ William R. Thompson □ Del Thorndike and Steve Teicher □ James E. Thornton □ Robert W. Thornton □ Erwin Tomash □ Michael G. Tomasic □ Fritz & Nomi Trapnell □ Gregory A. Tutunjian & Linda M. Watson □ Michael G. Uhler □ University of New Orleans □ George E. Valley, Jr. □ Alexander Vanderburgh, Jr. □ Professor DVR Vithal □ Jerome Vuoso □ Christian Walker □ Susan Walter □ Joseph B. Walters, Jr. □ Dr. An Wang □ W. Joe Watson □ Wendell Weatherford □ Thomas E. Welmers □ Lih J. Weng □ J.T. West □ Christopher Grey Westbury □ John D. Wick □ J. B. Wiesner □ Harvey W. Wiggins, Jr. □ Maurice V. Wilkes □ George H. Williams □ Herbert E. Willman, Jr. □ Norman Wilson □ Andrew Wilson □ Professor Jean C. Wirsig □ Professor Niklaus Wirth □ Frederic & Ruth Withington □ T. J. Wojcik, Jr. □ William Wolfson □ Leonard W. Woodall □ Dr. James W. Woods □ Bill Wulf □ D.L. Wyse □ Richard H. Yen

Contents

- 1** The Director's Letter
- 4** The Collection
- 11** The Apple I
- 13** Pre-Preview Party
- 16** Letter to Editor
IBM System/360 in Conclusion
- 17** Membership
Catalog Corner

Cover and back cover:

The Computer Museum would like to thank the hundreds of individuals (listed on the cover) and corporations (listed on the back cover) who gave more than \$250 or \$2500 respectively during the Museum's first two years.

The Founders program was in effect until June 24, 1984. It provided an opportunity for the Museum to become a widely-supported public institution so it could be designated a public, non-profit charitable foundation by the IRS.

With the Founders program complete, there are now new membership categories available. These new membership categories can be found elsewhere in this issue.

Photo Credits:

Boyd Norcross pp. 4, 5, 6, 7, 8, 9, 10, 12, 13, 14, 15

THE COMPUTER MUSEUM

The Computer Museum is the only museum of its kind in the world. It dramatically illustrates the impact of the Information Revolution through interactive exhibits of state-of-the-art computers, films and creations of vintage computer installations.

The Museum hours will be: 11 a.m.-6 p.m. Wednesday, Saturday and Sunday and 11 a.m.-9 p.m. Thursday and Friday. It will be closed Mondays, Tuesdays, Christmas, New Years and Thanksgiving. Its new location at 300 Congress Street is minutes from Logan International Airport and just a short walk from Boston's financial district and such historic landmarks as Faneuil Hall and the Freedom Trail.

The Museum offers individual memberships for \$30. Other membership categories are available for corporations and those individuals seeking a higher level of participation. All members receive a free subscription to The Computer Museum Report, a 10% discount on merchandise from The Computer Museum Store, free admission and invitations to Museum previews.

For more information, contact Jana Buchholz, Membership Coordinator at The Computer Museum, 300 Congress Street, Boston, MA 02210, (617) 426-2800.

THE COMPUTER MUSEUM REPORT (ISSN 0736-5438)

The Computer Museum Report is published quarterly by The Computer Museum, 300 Congress Street, Boston, MA 02210. A yearly subscription to The Computer Museum Report is free with membership. Individual issues can be purchased through The Computer Museum Store for \$3 apiece.

The Museum staff is responsible for the contents of the Report. The views expressed do not necessarily represent those of The Computer Museum or its Board of Directors.

Design and production of the Report is done by Benson and Clemons.

STAFF

Director
Dr. Gwen Bell

Administration
Geri Rogers

Business
Eva Radding

Communications
Stephanie Haack
Brenda Erie

Development
Michael Oleksiw

Exhibits and Archives
Meredith Stelling
Paul Ceruzzi
Andrew Kristoffy
Beth Parkhurst
Katherine Schwartz
Dr. Oliver Strimpel
Gregory Welch
Bill Wisheart

Membership
Jana Buchholz

Programs
Mary Cooper

Store
Lea Cohen

BOARD OF DIRECTORS

John William Poduska, Sr., Chairman
Apollo Computer, Inc.

C. Gordon Bell
Encore Computer Corporation

Dr. Gwen Bell
The Computer Museum

Erich Bloch
International Business Machines

Harvey D. Cragon
Texas Instruments

David Donaldson
Ropes and Gray

Robert Everett
The MITRE Corporation

Dr. Sydney Fernbach
Computer Consultant

C. Lester Hogan
Fairchild Camera and Instrument Corporation

Theodore G. Johnson

Mitchell Kapov
Lotus Development Corporation

Dr. Koji Kobayashi
NEC Corporation

John Lacey
Control Data Corporation

Patrick J. McGovern
CW Communications, Inc.

James L. McKenney
Harvard Business School

George Michael
Lawrence Livermore Laboratories

Dr. Arthur P. Molella
The National Museum of American History,
Smithsonian Institution

Kenneth H. Olsen
Digital Equipment Corporation

Brian Randell
University of Newcastle upon Tyne

Jean E. Sammet
International Business Machines

Edward A. Schwartz
Digital Equipment Corporation

Kitty Selfridge
Henco Software, Inc.

Erwin Tomash
Dataproducts

Dr. An Wang
Wang Laboratories, Inc.

The Director's Letter

In our countdown to opening the Museum, I am pleased to have the opportunity via the report to reflect on the evolution of the Museum. Five years ago, I was charged with the task of creating a "computer museum." The only models at that time were IBM's dismantled history wall done by Charles Eames in the sixties, the small exhibit of historic machines at the Smithsonian, and the interactive and historic collections at the Science Museum in London. None of these could be collected and brought back. And I felt as though I had been told to "Go fetch a rock." Every time I brought an idea back, the feedback was quick: "That's not the rock," or "How did you ever get that—it's just great."

Two and a half years ago, on June 10, 1982, The Computer Museum opened its doors for the first time: we had 50 Founders, 200 members and 3,000 square feet of dedicated exhibit space. Our goals were to develop an international collection, create exciting exhibitions, sponsor educational programs, and attract a worldwide membership. On June 24, 1984, at the end of our Founding period, we will boast 504 individuals and corporate Founders. I am glad to extend special thanks to the individuals listed on the front cover and the corporations listed on the back cover helping to found the Museum.

The Second Opening

On Wednesday, November 14, 1984 at 11:00 a.m., the Museum will formally open its doors a second time to the public. This time we will have 16,000 square feet of exhibitions of both historic computers and state-of-the-art interactive displays; another 8,000 square feet of exhibit space and 4,000 square feet for library/study collections will be developed later. As we approach our opening we can be pleased that we have by far the largest exhibition area devoted to computing and information processing at any museum.

Let me give you a brief tour of our plans for the exhibitions: After rising to the Museum on a large, glass-enclosed elevator overlooking downtown Boston, the visitor is confronted by the Whirlwind, a vacuum tube computer that seems to go on forever.

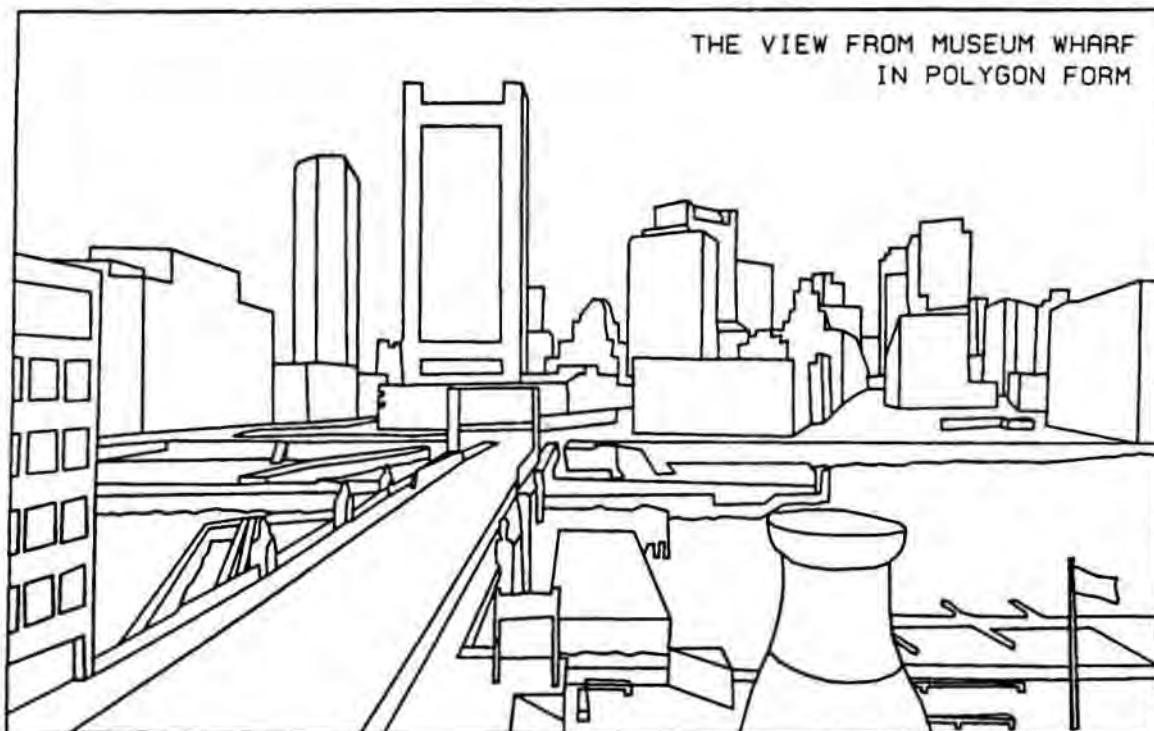

Going around the corner, the visitor enters the SAGE computer room. Here the major components of the world's largest and longest lived computer simulate their installed environment. The visitor can "start" the console and see its banks of lights cycle-up. Beside each component, such as the 30-foot-long accumulator, today's equivalent chip (or part of a chip) has been placed for comparison. This arrangement reinforces an awareness of decreasing size and power and increasing programming capabilities.

For the history buff, a year-by-year timeline from 1950 to 1970 shows the fundamental inventions, the major computers, major software developments and benchmark applications.

The CW Communications "See It Then" theater shows films of operational computers, starting in the 1920's and ending in the 1960's with the IBM Stretch. The films are complemented by a 1965 IBM 1401 computer room, where the visitor can punch cards, and an operating PDP-89, the classic (but now very slow) minicomputer.

The evolution of Seymour Cray's work illustrates a single hardware contributor and his philosophy. The story begins with the NTDS-17 that he built for the Navy at UNIVAC in Minneapolis, which Greg Mellen, who is still at Sperry Univac, helped the Museum acquire; after that Cray built the Little Character, his first machine at CDC, presented by Control Data Corporation; then to the 6600, Serial Number 1, presented by Lawrence Livermore Laboratories; and finally to components of a Cray I, presented by the Cray Corporation. We have two videotapes of Seymour Cray, one from Lawrence Livermore Laboratories and another given to us by Joe Clarke, a former employee of CDC, who bought a two inch video tape player at a company sale and found on it a tape of Seymour Cray.

The next gallery focuses on chips and their place in the computer revolution, and the process of manufacturing computers. The inside of the "black box" is revealed, and an important, hidden part of the process is illustrated.

This collection of personal computers goes back to the very first one, the 1962 LINC, and extends to the latest models. The ring of live machines, each showing off an aspect of its special input/output, include DECTALK, a touch sensitive screen HP 150 and others.

The final gallery, is devoted to "the computer and the image." Here, the visitor will be able to explore image processing by computer, such as evaluation of landsat data, and image creation by computer, such as computer-aided design. Without much trouble, the visitor could spend two hours in this room experimenting and viewing.

The exhibits are only the tip of the iceberg of our collection of artifacts, working machines, software, documentation, photographs and films. The listing in this report represents one year's accumulation and the collection is rapidly growing.

The Evolving Board of Directors

At the first meeting of the board of directors in 1982, two decisions were made: one was to have non-renewable four-year terms and the other was to limit the number to 24 people. This year five directors retired, I was made an ex-officio director, and five new directors were elected.

The five retiring directors each played a significant role in our growth to date: Charles Bachman served as chairman of the executive committee through our critical first two years; Andrew Knowles provided our initial space in Marlboro; Robert Noyce was key in starting our semiconductor collection and gave a wonderful lecture at our pre-preview party; Michael Spock, director of the Children's Museum, had the idea of our move to the Wharf and continues to counsel us on a day-to-day basis as our closest neighbor; and the Honorable Paul Tsongas helped bring us recognition at a national level.



John William Poduska, Sr.
Apollo Computer, Inc.



Mitchell Kapor
Lotus Development Corporation



Dr. An Wang
Wang Laboratories, Inc.



Dr. Koji Kobayashi
NEC Corporation



Dr. Arthur P. Molella
The National Museum of American History,
Smithsonian Institution

The new directors bring a new set of talents. Bill Poduska, the new chairman of the board, is chief executive officer and chairman of the board of Apollo Computer, Inc. which he founded in 1980. He came to MIT as an undergraduate and stayed through a Ph.D. in electrical engineering, which he taught for four years. Then he went on to become the director of the Honeywell Information Science Center before founding Prime Computer and Apollo Computer.

Mitch Kapor, president and co-founder of Lotus Development Corporation, looks at the role of computers from the point of view of a non-technical user. A psychology major from Yale with what he calls "three-quarters of a masters degree" from MIT's Sloan School of Management, he developed VisiPlot and VisiTrend for VisiCorp before working on "1-2-3," the business applications program for personal computers, that became the basis for Lotus. Mitch has expressed his concern for the end user, saying, "When we stop listening we will cease to be viable." This is equally true for the Museum when we open our doors to the public.

Dr. Koji Kobayashi, chairman and chief executive officer of NEC Corporation, began his life-long career with them in 1929. NEC preserved Japan's first transistor business computer the NEAC 2201 which they agreed to give to the Museum. This represents an important acquisition in our goal to develop an international collection. Dr. Kobayashi is also interested in the current technology, especially communications and computers, and will provide an important link to Japan.

Dr. Arthur P. Molella is chairman of the history of science and technology department at The National Museum of American History, Smithsonian Institution. Specialized museums, such as ours, have an important symbiotic relationship with the Smithsonian. We can focus on a single subject, collect, carry out research and prepare exhibitions. At the Smithsonian, Arthur has to trade off all aspects of science and technology and allocate appropriate space and personnel.

We intend to help each other, the Smithsonian has already loaned several important pieces from their collection for our opening exhibition. And when the new Smithsonian exhibit on computing opens, we will help them.

Dr. An Wang, chairman of the board and chief executive officer of Wang Laboratories, Inc., is one of the computer pioneers. He invented the magnetic pulse controlling device for the Harvard Mark IV which will be on display in the timeline planned for our opening exhibition. Wang not only founded Wang Laboratories, Inc. but also the Wang Institute of Graduate Studies in 1979.

Since 1982, the course of The Computer Museum has changed in ways that I would never have predicted, but new directions that, in retrospect, always made sense. This distinguished new class of directors will help the Museum become a strong institution as it opens to the public.

Gwen Bell

The Collection

The following listing of the Museum's collection includes all new artifacts and archival material received between April 10, 1983 and June 13, 1984. The number of artifacts and films has grown to 900 catalogued items. The artifacts range from a single chip to the multiple components of a single large-scale computer. In addition, the document and photograph collection has also increased dramatically. Archival donations are catalogued as complete collections.

Artifacts

Each artifact is described according to its manufacturer, date, and characteristics according to the PMS notation system developed in *Computer Structures* by Gordon Bell and Allen Newell. The PMS notation divides computer structures into processors (calculators), memory, links and switches, transducers, and control devices. Robots have been added. This system was then used to divide the list of artifacts in order to provide a better picture of the collection.

Archives

The archives supply supporting materials for the artifacts. They help the scholar reconstruct the development and use of any of the artifacts. For example, old textbooks provide significant insight into the principles and uses of a machine from the same period. Similarly, films and photographs often illustrate the working environment of artifacts.

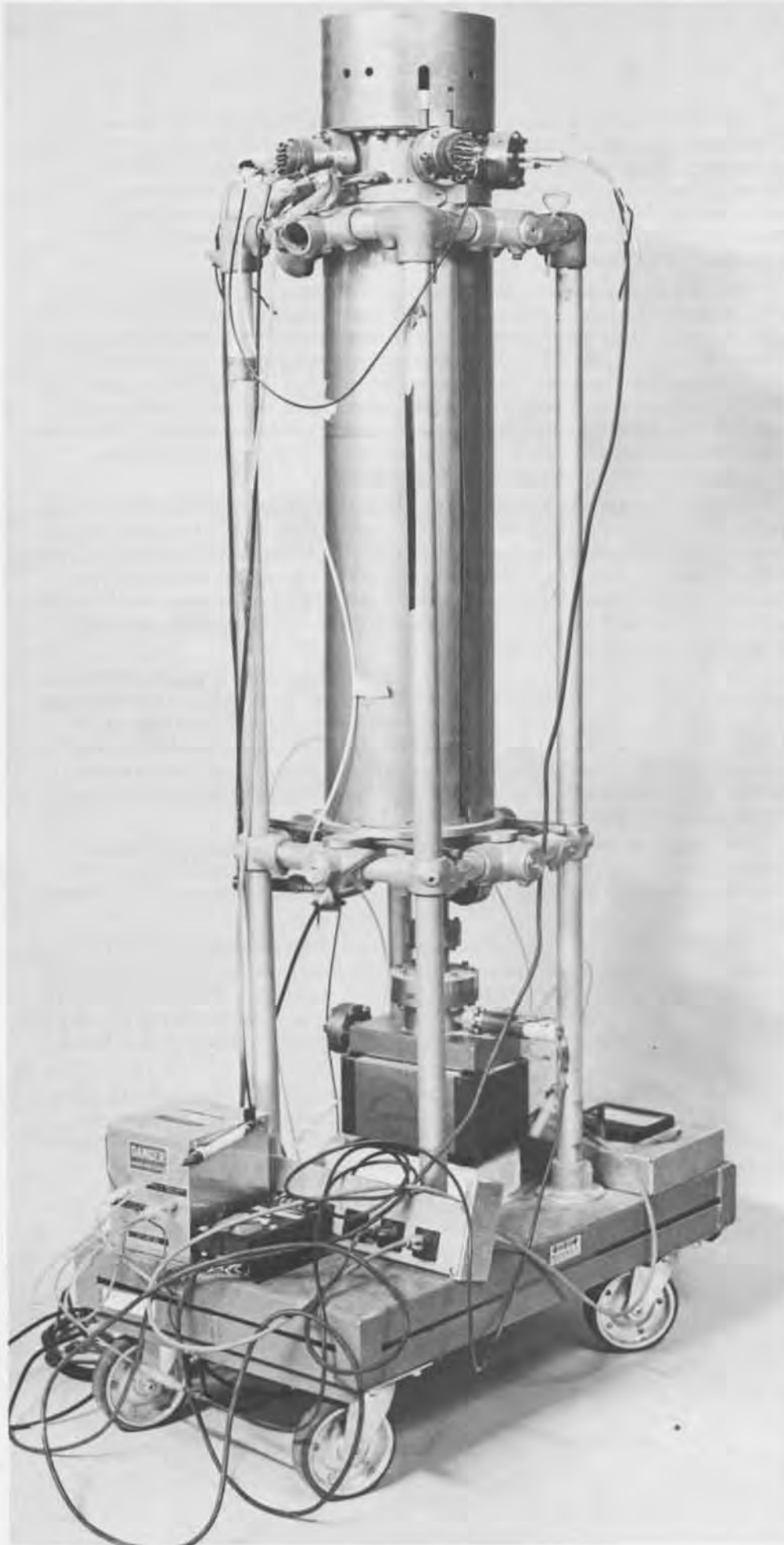

Micro-bit Electron Beam Access Memory. This memory device is Micro-bit's Electron Beam Access Memory affectionately known as ALICE. Although this device was never marketed, it got up and running at the end of December 1971. It took, recorded and played back the following message: "Merry Christmas. Send more money."



TRS-80. TRS-80 Model I's, like the one pictured here, were introduced by Tandy Radio Shack Corporation in 1977. During that same year the Apple II and the Commodore Pet 2001 were introduced, establishing the first three personal computer designs to come assembled with BASIC built into the firmware, which allowed them to achieve a BASIC operating mode on power up. The TRS-80 Model I is one of several PC's that will be featured in the Personal Computer exhibit when the Museum opens November 14, 1984.

Apple Computer Company,
Apple I (X210.83)
Gift of Dysan Corporation

Burroughs Corporation,
Burroughs B-500 (X312.84-X321.84)
Loan from Design Pak, Inc.

Burroughs Corporation,
Burroughs TC500 (X309.84)
Gift of LADDIS Corporation

Digital Equipment Corporation,
DEC Digital Trainer (X220.83)
Gift of Jerrold Petrofsky

Digital Equipment Corporation,
Digital Music Synthesizer
(XD388.83)
Gift of Digital Equipment Corporation

Digital Equipment Corporation,
PDP-1 (D379.83); PDP-1
Oscilloscope, Soroban and
Microtape 555 (D382.83) (D385.83)
Gift of Digital Equipment Corporation

Digital Equipment Corporation,
PDP-8 (X231.84)
Gift of Jim Selder

Digital Equipment Corporation,
PDP-8 (D378.83) (D381.83) (XD356.82)
Gift of Digital Equipment Corporation

Digital Equipment Corporation,
PDP-9 (D389.83)
Gift of Digital Equipment Corporation

Franklin Computer Corporation,
Franklin Ace 100 (X340.83)
Gift of Franklin Computer Corporation

International Business Machines,
IBM 083 Sorter (X291.83); IBM 088
Collator (X290.83); IBM 519
Reproducer (X292.83); IBM
557 Interpreter (X289.83)
Gift of Bumdy Corporation

International Business Machines,
SAGE: AN/FSQ-7 Duplex and
Simplex Maintenance Consoles
(X260.83) (X269.83); Left Arithmetic
Unit (X274.83); Magnetic Drum
Unit (X261.83) (X273.83); 64K Core
Memory Plane (X272.83); IBM 728
Tape Drives (X268.83); IBM 718
Printer (X262.83); IBM 20 Card
Punch (X266.83); IBM 723 Card
Recorder (X267.83); IBM Card
Reader (X270.83); Display and
Auxiliary Consoles (X263.83)
(X264.83) (X265.83) (X271.83)
Gift of National Museum of Science and Technology, Ottawa

International Business Machines,
SAGE: AN/FSQ-7 Left Arithmetic
Unit (X311.83); Core Memory Stack
2 (X310.83)
Gift of Hancock Field Air Force Base, New York

International Business Machines,
IBM System 3 (SYS/3) (X192.83)
Gift of Hesser College

International Business Machines,
IBM 1401 System (X233.83)
Gift of American Computer Group, Inc.

Kurzweil Computer Products,
Inc.,
Kurzweil Reading Machine
(X236.83)
Gift of Kurzweil Computer Products, Inc.

Mathatronics, Inc.,
Mathatron (X283.83)
Gift of Yutaka Kobayashi

MITTS,
MITTS CT 256 (X334.84)
Gift of Geoff Feldman

Olivetti-Underwood, Inc.,
Olivetti-Underwood Program
101C (X300.83)
Gift of GTE

Sperry Rand Corporation,
UNIVAC 494 (X343.84)
Gift of Travelers Insurance Company

Sphere Corporation,
SPHERE System 320 (X297.83);
SPHERE System 330 (X295.83)
Gift of Roger J. Spott

Tandy Corporation,
TRS-80, Model I (X348.84)
Gift of Samuel M. Gerber

Terak Corporation,
Terak Model 8510 (X351.84-X353.84);
Terak Model 8512 (X354.84)
Gift of Douglas Ross

Viatron Computer Systems
Corporation,
Viatron System 21 (X350.84)
Gift of Fred De Bros



Burroughs B-500. The front control panel of a Burroughs B-500 Central Processing Unit. Released in 1968, it was the small-scale end of the Burroughs "500" family.

Air Force Cambridge Research Laboratories,
Trigger Pair V EMS Circuit Boards,
Pulse Generator Circuit Boards
(X226.83) (X275.83)
Gift of Gunars Zaghars

Bendix Corporation,
Bendix G-15 Logic Modules
(X235.83)
Gift of Ron Resch

Burroughs Corporation,
Electrodata Division,
Electrodata Plug Board (X209.83)
Gift of Claude A. R. Kagan

Digital Equipment Corporation,
MicroVAX I Data Path (X326.84);
MicroVAX I Memory Controller
(X325.84)
Gift of Digital Equipment
Corporation/DECwest Engineering

Digital Equipment Corporation,
Unibus NI Adapter Breadboard
(D386.83)
Gift of Digital Equipment
Corporation

Ferranti Corporation,
ARGUS 200 Pegboard Program
Tray (X337.84)
Loan from Science Museum,
London

International Business Machines,
IBM BLT Logic Card (X221.83)
Gift of John Shriver

International Business Machines,
IBM SSEC Mercury Wetted Contact
Relay (X194.83); IBM SSEC Wire
Contact Relay (X195.83)
Gift of A. Wayne Brooke

International Business Machines,
IBM Plug Board (X339.84)
Gift of LaSalle National Bank

Institute for Numerical Analysis,
National Bureau of Standards,
SWAC Chassis Unit (X228.83)
Loan from the Smithsonian
Institution, National Museum
of American History

Kollmorgen Corporation,
Multiwire Division,
Multiwire Boards (X237.83)
Gift of Multiwire Division,
Kollmorgen Corporation

Kollmorgen Corporation,
PCK Technology,
Wiring Head (X196.83); Discrete
Wired Circuit Boards (X226.83)
Gift of PCK Technology Division,
Kollmorgen Corporation

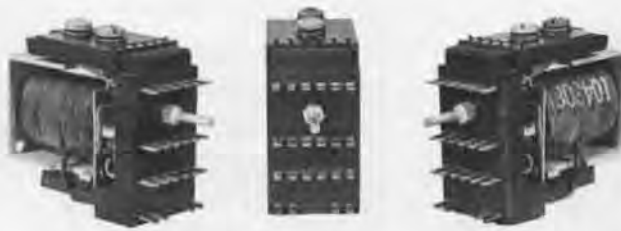

IBM SSEC Wire Contact Relays. The wire contact relays pictured here are from the IBM SSEC (Selective Sequence Controlled Electronic Calculator). The IBM SSEC was the first machine that could control its calculating sequence by modifying its own instructions. However, it was disputed whether or not the IBM SSEC was wholly electronic, because the machine had 13,500 vacuum tubes and 21,400 electromechanical relays.

Logistics Research, Inc.,
ALWAC III Control Panel, (X306.84);
ALWAC III Logic Boards (X307.84)
Gift of Eugene Usdin

MIT Lincoln Laboratory,
TX-2 Module Test Panel (D384.83)
Gift of Digital Equipment
Corporation

MIT Lincoln Laboratory,
TX-2 Flip-flop (X218.83)
Gift of Alan V. Oppenheim

Moore School of Electrical
Engineering,
ENIAC Function Table (X338.84)
Loan from The Smithsonian
Institution, National Museum
of American History

Motorola, Inc.,
MC6800 Microprocessors (X224.83)
Gift of Motorola, Inc.

Mullard, Ltd.,
Logic Boards from the Elliot 803B
British Germanium Transistor
Computer (X278.83)
Gift of Mr. Soper

National Semiconductor
Corporation,
NS32032 Microprocessor (X344.84)
Gift of National Semiconductor
Corporation

Phillips (N.V. Electrologica),
Electrologica X-8 Circuit
Boards, (X219.83)
Gift of Gordon Bell

Raytheon Company,
RAYDAC Logic Module (X234.83)
Gift of Bert Larey

Scientific Data Systems,
SDS 940 Modules (X285.83)
Gift of Systems Concepts



BIZMAC Clock. The BIZMAC was the result of an early attempt by RCA to produce a large-scale general-purpose computer for business applications. With its 29,000 tubes and 63,000 diodes, it was certainly one of the largest first generation computers ever built. The BIZMAC was one of the first commercial computers to use magnetic core memory. Later computers with full-scale core memories made BIZMAC obsolete.

USSR GOVERNMENT, MINSK-2 Logic PC Board. Introduced in 1962, the MINSK-2 became one of the most heavily used general-purpose computers in Russia. Each computer had a set of 107 two-address instructions and a word length of 37 bits. Their computing speed was 5,000 instructions per second and a floating-point addition took 72 microseconds. The main memory on the MINSK-2 was on ferrite cores, with either 4,000 or 8,000 words and secondary memory was on magnetic tapes.

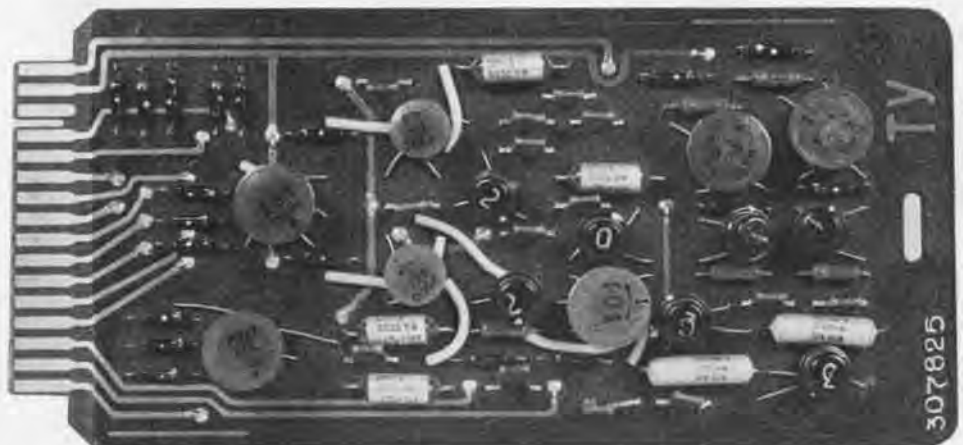

Sperry Univac Corporation,
Univac Solid State 80/90
Experimental Board, Magnetic
Amplifier and Amplifier
Components (X238.83)
Gift of Ted Bonn

Sylvania Electric Products, Inc.,
MOBIDIC Logic Boards (X188.83)
Gift of Jack Stevens

University of Illinois,
ILLIAC I Semi-Cylindrical Vacuum
Tube Chassis (X255.83); ILLIAC II
Chassis (X259.83); ILLIAC II Circuit
Board (X247.83); ILLIAC II Sense
Amplifier (X280.83); ILLIAC III
Circuit Boards (X246.83)
Gift of University of Illinois

Unknown,
Triode Power Supply Control
Rectifier (D391.83)
Gift of Gordon Bell

USSR Government,
MINSK-2 Logic Board (X327.84)
Gift of Dileep Bandaker

Wickes Engineering and
Construction Company,
BIZMAC Clock (X305.84)
Gift of Nell Kleinberg

Analex Corporation,
Analex Core Drive 200 Module
(XD234.81)
*Gift of Digital Equipment
Corporation*

Cambridge University
Computation Laboratory,
EDSAC Memory Driver (X335.84);
EDSAC Mercury Memory Tank
Cover (X336.83)
*Loan from Science Museum,
London*

Control Data Corporation,
Microbit Division,
Electron-beam Accessed Memory
Tube, (X215.83)
Loan from Charles A. Brown

Digital Equipment Corporation,
Magnetic Tape Unit (D380.83);
Tape Drive (D395.83)
*Gift of Digital Equipment
Corporation*

Digital Equipment Corporation,
PDP-10 Core Memory Board
(X286.83)
Gift of Systems Concepts

Digital Equipment Corporation,
PDP-12 Core Memory Stack
(X223.83)
Gift of Peter Sredojevic

Digital Equipment Corporation,
Plasma Cell Memory (X206.83)
Gift of Ron Nuebling

Digital Equipment Corporation,
Read Only Rope Memory (X294.83)

Ford Motor Company,
Aeronutronic Division,
10 Megacycle BIAX Cores (X242.83)
Gift of G.B. Westrom

Goodchild, C.W.,
"Complete Mathematical Chart"
(X245.83)
*Gift of University of Illinois,
Department of Computer Science*

Hewlett-Packard Company,
Fixed-head Drum Memory 2771A
(X207.83)
Gift of TSC Computer Ltd.

International Business Machines,
IBM 610 Programmable Calculator
Drum (X179.83)
Gift of Richard E. Smith

Institute for Numerical Analysis,
National Bureau of Standards,
SWAC William's Tube (X227.83)
*Loan from The Smithsonian
Institution, National Museum of
American History*

Micro-bit Corporation,
Electron Beam Access Memory:
ALICE I (X329.84)
Gift of Micro-bit Corporation

MIT Instrumentation
Laboratory,
Apollo Memory Stack Module
(X186.83)
Gift of Boguslaw Frackiewicz

Mullard, Ltd.,
Ferrite Core Memory from Elliot
803B British Germanium Transistor
Computer, (X277.83)
Gift of Mr. Soper

Rand Corporation,
Johnniac Selection Tube (X281.83)
Gift of Fred Gruenberger

Radio Corporation of America,
Electron Tube (X301.83)

Radio Corporation of America,
RCA 3488 Magnetic Cards
(X232.83)
Gift of Daniel Klein

Radio Corporation of America,
RCA 128 x 136 3-wire Core
Memory Plane (X190.83);
RCA 64 x 64 4-wire Core
Memory Plane (X189.83) (X191.83)
Gift of Boguslaw Frackiewicz

Remington Rand, Inc.,
Eckert-Mauchly Division,
Uniservo (X284.83)
Gift of R. S. Nelson

Roman Art Company,
Punched paper tape from
contemporary Jacquard loom
(X276.83)

Scheutz, George and Edward,
Specimens of Tables, Calculated,
Stereomoulded, and Printed by
Machinery. (X187.83)
Loan from Frederick J. Beutler

Union Label Company,
McBee Keysort Needle Cards
and Punch (X328.84)
Gift of Gordon Bell

Unknown,
Mercury Delay Line (X282.83)
Gift of Arthur Uhler

Anderson Jacobson,
Anderson Jacobson Acoustic
Data Coupler 260 (D392.83)
*Gift of Digital Equipment
Corporation*

Coxhead Corporation, Ralph C.,
Vari-typewriter (X240.83)
Gift of Lee Swanson

Friden Corporation,
Flexowriter (XD325.81)
*Gift of Digital Equipment
Corporation*

Harvard University,
Division of Applied Science,
Color Viewing Helmet for the
Space Pen (X197.83)
*Gift of Harvard University, Division
of Applied Science*

International Business Machines,
IBM 01 Typewriter (X199.83)
Gift of Richard Boylan

International Business Machines,
IBM 26 Printing Card Punch
(X322.84)
Loan from Design Pak, Inc.

National Data Industries, Inc.,
DIABLO HYTYPE I Daisywheel
Printer (X299.83)
Gift of Roger J. Spott

Sanders Technology, Inc.,
Sanders Media 12/7 Printer
(X355.84)
Gift of Douglas Ross

Southwest Technical Products,
Corporation,
Alphanumeric Parallel Printer
PR-40 (X298.83)
Gift of Roger J. Spott

Sperry Rand Corporation,
UNIVAC keyboard (D394.83)

Telesensory Systems, Inc.,
Optacon Print Reading System
(X229.83)
Gift of Telesensory Systems, Inc.

Teletype Corporation,
Bell System Model 12 Page Printer
(X202.83)
Gift of John LeProux



Acoustic Data Coupler. This Anderson Jacobson Acoustic Data Coupler 260 (circa 1963) is one of the earliest modems. A modem is an acronym for MODulator DEModulator unit, a device that converts data from a form that is compatible with data processing equipment to a form that is compatible with transmission facilities, and vice-versa.

Baby Calculator,
Baby Calculator (X213.83)
Gift of Gordon and Gwen Bell

Bachman, Charles,
Circular Slide Rule (X342.84)
Gift of Charles Bachman

Bowmar Instrument Corporation,
Bowmar MX70 Memory
Calculator (X216.83)
Gift of Ian Gunn

Carbic, Ltd.,
Otis King's Pocket Calculator
(X214.83)
Gift of I. Bernard Cohen

Dennert & Pape Company,
Aristo Darmstadt Slide Rule
(X333.84)
Gift of I. Bernard Cohen

Dietzgen Company,
Smith's Improved Protractor
(X243.83)
*Gift of University of Illinois,
Department of Computer Science*

Dietzgen Company,
Dietzgen Redirule Slide Rule
(X331.84)
Gift of I. Bernard Cohen

Egli, Hans,
Millionaire Calculator (X211.83)
Gift of Paul J. Harrington

Egli, Hans,
Millionaire Calculator (X252.83)
*Gift of University of Illinois,
Department of Computer Science*

Faber-Castell Company,
Slide Rule (X332.84)
Gift of I. Bernard Cohen

Felt & Tarrant Manufacturing
Company,
Comptometer (X349.84)
*Gift of Herbert and Virginia
Eldridge*

Friden Calculating Machine
Company,
Friden Model D8 Calculator
(X304.84)
Gift of Lee Bauer

Friden Corporation,
Friden Calculator (X230.83)
Gift of Dave Stone

General Business Machines
Corporation,
Automatic Printing Calculator
(X200.83)
Gift of Peter Stalker

Harmann Manus,
De Te We (XD190.80)
*Loan from Declan and Margrit
Kennedy*

Hewlett-Packard Company,
HP-55 Calculator (X198.83)
Gift of Randolph S. Canham

Hewlett-Packard Company,
HP-65 Programmable Calculator
(X241.83)
Gift of Stephen and Barbara Gross

Keuffel & Esser Company,
Fuller's Cylindrical Slide Rule
(X250.83); Thacher's Cylindrical
Slide Rule (X253.83); Planimeters
(X248.83) (X249.83) (X251.83);
Drawing instruments (X257.83)
(X258.83)
*Gift of University of Illinois,
Department of Computer Science*

Marchant Calculating
Machine Company,
Marchant Calculator (X347.84)
Gift of Fred Gruenberger

Monroe Calculating Machine
Company,
Monroe High Speed Adding
Calculator (X239.83)
Gift of Lee Swanson

National Semiconductor
Corporation,
NOVUS 650
Fixed Point Calculator (X302.83)
Gift of Harriet and Martin Agulnek

Reliable Typewriter and Adding
Machine Corporation,
VE-PO-AD (Vest Pocket Adder)
(X204.83)
Gift of M.M. Cragon

Reliable Typewriter &
Adding Machine Company,
Addometer (X323.84)
Gift of George J. Kelly

Riefle Nessel Wang
and Munchen Company,
Drawing Instrument (X254.83)
*Gift of University of Illinois,
Department of Computer Science*

Shure Brothers, Inc.,
Reactance Slide Rule (X303.83)
Gift of Claude A.R. Kagan

Tasco Industries,
Pocket Arithmometer (X208.83)
Gift of J. M. Shag Graetz

Tasco Industries,
Pocket Arithmometer (X288.83)
Gift of Jacqueline Tyrwhitt

Texas Instruments, Inc.,
TI-2500 Datamath Electronic
Calculator (X217.83)
Gift of Ian Gunn

Unknown,
Binary Slide Rule (X287.83)
Gift of Jacqueline Tyrwhitt

Unknown,
Drawing Instrument (X244.83);
Pantographe (X256.83)
*Gift of University of Illinois,
Department of Computer Science*

Victor Adding Machine Company,
Victor Adding Machine (X201.83)
Gift of Henry Merrill, III

Wang Laboratories,
Wang Model 360K Electronic
Calculator (X308.84)
Gift of Robert Caron

Wang Laboratories,
Wang Model 500-0 Programmable
Calculator (X222.83)
Gift of Ocean Data Systems

Western Electric Company,
Hollerith Tabulating Machine
Counter (X193.83)
Gift of A. Wayne Brooke

Wolf Research and
Development Corporation,
Pert VIP Time Data Converter
Circular Slide Rule (X330.83)
*Gift of Wolf Research and
Development Corporation*

Wyle Laboratories,
Wyle SCIENTIFIC
Electronic Calculator (X212.83)
Gift of Glenn C. Stewart



Planimeter. This exquisite Keuffel & Esser Planimeter is one of many fine drafting and drawing instruments donated to The Computer Museum by the Computer Science Department at the University of Illinois. Planimeters were used to determine the area of a closed curve.

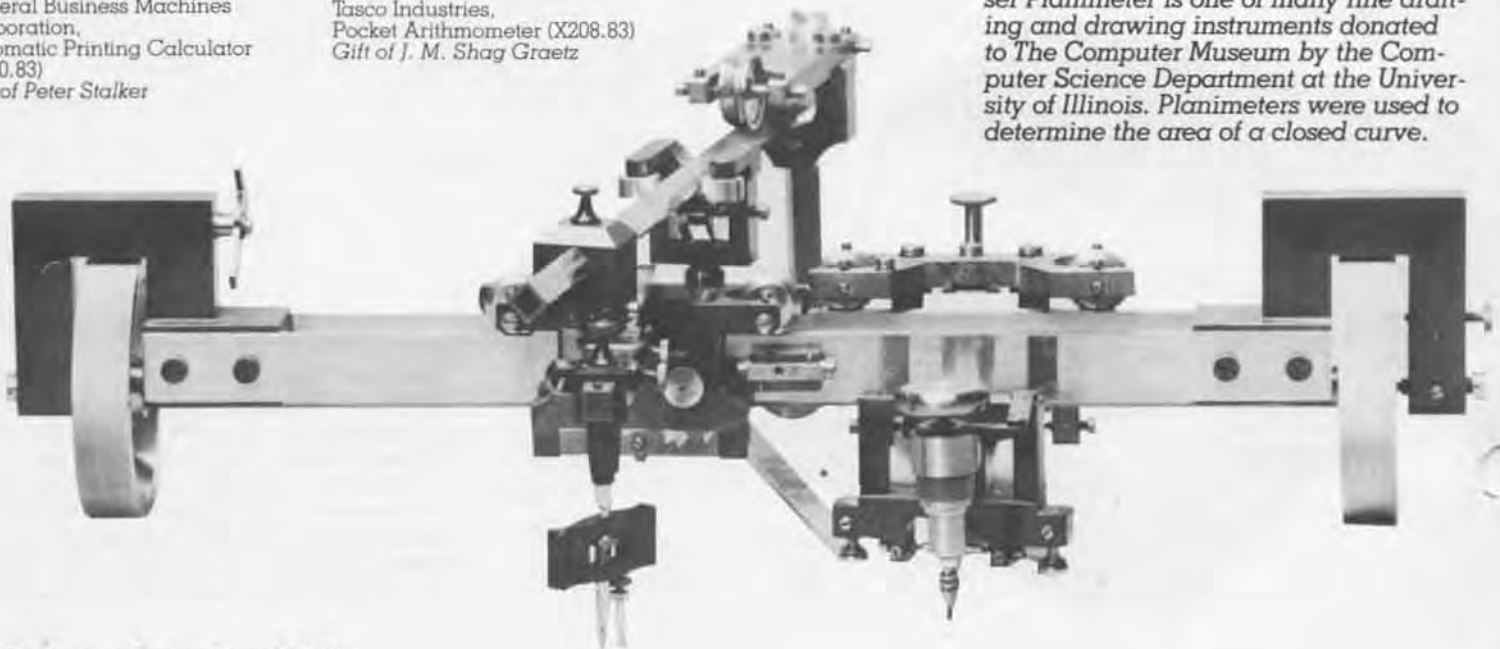



Miscellaneous Artifacts

Comet Metal Products Company,
Model of Sylvania MOBIDIC
(Mobile Digital Computer) (X205.83)
Gift of Frederick W. Paget

Ecole municipale de tissage de
Lyon Dessin de Ch-Michel d'apres
C-Bonnefond, Jacquard portrait
woven in silk, (X341.84)
Loan from Gordon and Gwen Bell

MIT and USAF.
Ashtray: APT II (X356.84)
Gift of Douglas Ross

NASA, Jet Propulsion Laboratory,
Mariner 4 First Computer Image
of Mars, (X346.84)
*Loan from Jet Propulsion
Laboratory*

Robots

Automatix, Inc.,
Autovision 2 (X203.83)
Gift of Automatix, Inc.

Stanford Research Institute (SRI),
SHAKEY the Robot, (X279.83)
Loan from SRI International

Manuals and Documentation

ALWAC III Manuals and
Drawings, (84.3)
Gift of Eugene Usdin

Amdahl 470 Reference
Manuals, (83.23)
Gift of Lloyd Dickman

AN/FSQ-7 Programming
Cards, (84.28)
*Gift of Computer Systems Division,
Griffiss Air Force Base*

Burroughs B-500 Manuals and
Documentation, (84.5)
Gift of Design Pak, Inc.

Byte, Interface Age, Kilobaud
Magazines, et. al. periodicals,
software, manuals and books,
(83.18)
Gift of Dr. Roger J. Spott

Computer, Data Communication,
and Programming books and
manuals, (83.22)
Gift of Gordon and Gwen Bell

Computer Science Press, Computer
Science Textbooks and other recent
publications, (83.24)
Gift of Computer Science Press

Datamation (1957-1981),
Creative Computing, Terak and
other documentation, (84.26)
Gift of Douglas Ross

DECsystem 10 & 20 and
TOPS Manuals, (84.8)
Gift of Sharon Lipp

Electron Beam Memories
Papers and Drawings, (84.7)
Gift of Sterling Newberry

Hewlett-Packard and IBM
Reference Data Cards, (84.18)
Gift of Harvey Morgan

IBM AN/FSQ-7 and IBM 704
Programmer cards, (83.21)
Gift of Alexander Vanderburgh, Jr.

IBM Punched Card Machine
Manuals, (84.11)
Gift of Marjorie Canto

IBM, Control Data Corporation,
and Digital Manuals.
Correspondence relating to early
programming timing results, (84.17)
Gift of Dr. Melvin Klerer

IBM, General Electric, Univac,
Burroughs, Digital, Honeywell,
et. al. Manuals, (84.1)
Gift of Neil R. Karl

IBM and other manuals, (84.25)
Gift of Frank C. Bequaert

Microcomputing (Kilobaud)
1977-1982, (84.27)
Gift of Joseph Clarke

NTDS CP-642 Naval System
Operator's and Programmer's
Manuals, (83.25)
*Gift of Sperry Corporation and
H. Stanwood Foote*

Packard Bell, Raytheon,
et. al. manuals, (83.20)
Gift of Claude A. R. Kagan

Personal Computer and Calculator
Brochures, Pamphlets, Catalogs
and other documentation, (84.20)
Gift of Harley R. Schneider

Reston Publishing Company,
*How to buy Business Computers,
Microcomputer Resource Book For
Special Education, VAX Pascal,
and Programmer Productivity,*
(84.16)
*Gift of Reston Publishing
Company, Inc.*

SAGE and Varian Computer
Documentation, (84.13)
*Gift of Computer Systems Division,
Griffiss Air Force Base*

Symbolic Logic, Boolean
Algebra and the Design
of Digital Systems, (84.9)
Gift of M. J. Gettleston

TRS-80 manuals, (84.23)
Gift of Samuel M. Gerber

UNIVAC and Remington
Rand Manuals, (84.5)
Gift of G. Muri Mohr

Viatron manuals and
papers, (84.24)
Gift of Fred De Bros

Wang Laboratory Manuals, (84.4)
Gift of Robert Caron

OCTAL INDEX INTERVAL CODES FOR XD-1

OPERATE		SENSE (Continued)	
Condition Lights 1-4 ON	01-04	Illegal Register or Section ON	62
Inactivity Alarm ACTIVE	05	G/A FD Parity ON	53
Inactivity Alarm OFF	06	G/G Parity ON	54
Parity Check Control OFF	07	Delayed Parity ON	55
Unlock Program Trap	10	G/A TD Parity ON	56
Clock Test	14		
Area Discriminators 1 & 2	17,20		
Start MC Excursion	21		
Stop MC Excursion	22		
Clear IO Interlock	27		
Operate Raydist	30		
SD Camera Modes 1 & 2 (L3 = 1 suppresses film advance)	31,32		
Operate Limbo Equipment	33		
Start DD, Sections 1 & 2	35,36		
Printer Hubs 1-10	31-42		
Start GFI Continuous Pattern Gen	63		
Start Program Pattern Gen, GFI	64		
GFI Azimuth, LRI & XTL Sync	65		
GFI Target, LRI & XTL Data	66		
Set Prepared (tapes)	67		
Backspace (tapes)	70		
Rewind (tapes)	71		
Write End-of-File (tapes)	72		
Punch Identification	73		
Gang Punch Identification	74		
Lock ID Address Counter	75		
Reset Scan Counter	76		
Step Scan Counter	77		
SENSE		SELECT MAIN DRUMS (bit R1 = 0)	
Condition Lights 1-4 ON	01-04	AM 1-12	02-15
Inactivity Alarm ON	05	IC Test	16
Not Prepared (tapes)	16	DD Test (identity, bits R14-15)	17
IO Unit Not Ready	11	Spare AM	20
Left Overflow ON	12	MI (status)	22
Right Overflow ON	13	MI (identity, bits R14-15)	23
IO Interlock ON	14	XTL (status)	24
Memory Parity Error	15	XTL (identity, bits R11-15)	25
Drum Parity Error	16	IC	26
Tape Parity Error	17	DD	27
MC Excursion ON	20	OB Write Odd, Test Read by identity bits R14-15	30
Sense Switches 1-4 ACTIVE	21-24	OB Write Even, Test Read by status	31
Printer Hubs 1 & 2 Energized	31,32	LRI (status)	32
Output Alarm ON	33	LRI (identity, bits R11-15)	33
GFI Range ON	34	GFI 1 (status)	34
Sense Contacts (ON when camera takes a picture)	35	GFI 1 (identity, bits R11-15)	35
Sense Display (ON when data from TD Drum is being displayed)	37	GFI 2 (status)	36
North Alarm ON	47	GFI 2 (identity, bits R11-15)	37
Non-Separate Alarm ON	50	XTL Marker	40
Output Drum Parity ON	51	TD 1-6	61-66
		SD Test (identity, bits R3-10)	67
		RD 1-9	68-70
		SELECT AUX DRUMS (bit S1 = 1)	
		AM C 13-18	41-48
		AM D 19-24	49-56
		AM E 25-30	57-64
		AM F 31-36	65-72
		AM G 37-42	73-80
		AM H 43-48	81-88
		SELECT	
		Card Reader	01
		Card Punch	02
		Printer	03
		IO Register	04
		Manual Input Matrix	05
		Warning Lights	10
		Magnetic Tapes 1-6	11-16
		Burst Time Counters	41

B-86501

ALEXANDER VANDERBURGH, JR.

SAGE Programmer Cards. These cards are from the SAGE, the U.S. air defense system from 1958-1983. Museum member Alexander Vanderburgh, Jr. recalls that these cards were used to interpret memory dumps that could be translated from numerical format to command format. They also contained the mnemonic code for the instruction set.

Ashtray. This aluminum ashtray donated by Douglas Ross, was made in February 1959 at MIT and is the first object produced using computer-aided design. Upon its announcement, the New Yorker ran this quote from the San Francisco Chronicle:

"The Air Force announced today that it has a machine that can receive instructions in English, figure out how to make whatever is wanted, and teach other machines how to make it. An Air Force general said it will enable the United States to 'build a war machine that nobody would want to tackle.' Today it made an ashtray."

Film:

"... from one John V. Atansoff," Iowa State University Media Services, 1983.
Gift of Iowa State University

"A CAM Update," Automatix, 1980.
Gift of Automatix

"Ford Tempo Advertisement," 1983.
Gift of Ford Motor Company

"F.P. Brooks, APPLE Computer Science Lecture Series," 1982.
Gift of Apple Video Services

"Computers That Build Computers," Fujitsu, 1979.
Gift of Fujitsu

"Graphic Rocket," The Rand Corporation, 1965.
Gift of Willis Ware

"Hollerith Punched Cards," "Punched Cards"
Gift of Bill Luebbert

"PEGASUS: A New Electronic Digital Computer," Film Surveys Ltd. for Ferranti, 1955.
Gift of Brian Randell

"POGO: Programmer-Oriented Graphics Orientation," The Rand Corporation, 1965.
Gift of Willis Ware

"SHAKY: Experimentation in Robot Planning and Learning," SRI International ca. 1970.
Gift of SRI International

"UNIVAC . . ." Seymode Zwiebel Production for Remington Rand's Eckert-Mauchly Division.
Gift of Sperry Rand Corporation

Investigating Computer Systems, 15 filmstrips and 10 Card Computing Films.
Gift of the Charles Babbage Institute, (84.10)

Newsclip of CDC 7600 announcement with Norris, Cray, et. al.
Gift of Joseph Clarke, (84.27)

Photographs:

Harold Cohen, photographs (84.12)
Gift of Harold and Beckey Cohen

Cray, Seymour, CDC 6600
Gift of Lawrence Livermore Laboratories

Ford Tempo Ads
Gift of Ford Motor Company

Pilot Ace
Gift of National Physical Laboratory

Punched Card Room, 2 b/w photographs.
Gift of The Travelers Insurance Company

US Navy
Gift of Naval Tactical Data Systems

JSS ROCC System:
5 color transparencies.
Gift of Computer Systems Division, Griffiss Air Force Base, (84.28)

SAGE, 13 photographs.
Gift of System Development Corporation, (84.21)

SAGE, 4 photographs and LIFE magazine 2/11/57.
Gift of IBM Communications, Kingston, (84.19)

SAGE-North Bay Installation, 5 photographs.
Gift of Hanscom Field Air Force Base, (84.14)

Stibitz, George
Gift of Bell Labs

TRADIC Computer
Gift of Bell Labs

UNIVAC 494, 2 color photographs.
Gift of The Travelers Insurance Company, (84.15)

Equipment:

Sony BVU 200B videotape player.
Gift of Sony Corporation of America, (84.22)

Pioneers. This photograph is part of The Computer Museum's archival collection. Pictured are British computer pioneers and other distinguished guests at the opening of the Science Museum's computing gallery in London, December 1975.



Back row, left to right: Donald Davis, Tom Flowers, Grace Hopper (USA), Jim Wilkinson, Tom Kilburn, Raymond Thompson, Maurice Wilkes, Cecil Marks, Allen Coombs. Front row: Mrs. Douglas Hartree, Fred Williams, Max Newman, David Wheeler, Konrad Zuse (Germany).

The Apple I

by Brenda A. Erie

When the Museum opens at its new quarters in downtown Boston on November 14th, 1984 an Apple I board will be part of the Museum's Personal Computer exhibit. Surrounded by a ring of state-of-the-art operational machines, the Apple I board will be exhibited with other personal computer ancestors such as the Altair and the Xerox Alto.

It is too difficult to put a price tag on the Apple I's current value because "only 210 to 220 Apple I's were ever manufactured," according to Stacey Farmer, of Apple Computer, Inc. This reliable microcomputer, which needed little assembly, was built in 1975 by Apple co-founders Steven P. Jobs and Stephen G. Wozniak. Primarily bought by computer experimenters and home computer novices the Apple I could be used for developing programs, playing games or running BASIC.

When the Apple I was inaugurated into the marketplace, the "two Steve's," (as they were nicknamed by their employees) had already established a design philosophy that still exists today at Apple—dedication to making their computers easy to use, understandable and inexpensive. They also recognized the need to incorporate suggestions from Apple I users to improve the production and sales of the machine.

The home computer market liked the Apple I because it was easy to assemble unlike some of the kits that were around in the mid-1970's. Rich Travis, a sales representative at the Sunshine Computer Company in Southern California did not directly promote the Apple I in 1977, but made the machine "easy to buy" for his customers because they were "looking for a complete, ready-to-run system that was inexpensive."

The Apple I was sold at computer stores throughout the United States. In 1977, *Kilobaud Magazine* ran an article by Sheila Clarke a computer hobbyist writer who found that owning the Apple I did not "require you to be either an electronics buff or a millionaire."

For instance if you had walked into the Byte Computer Store in San Jose, California to purchase an Apple I in 1977, you would have gotten a fully-guaranteed computer kit for \$666.66 that included: a printed circuit board with video terminal electronics, 8K bytes of RAM, 4 regulated power supplies, a keyboard interface and a hex monitor in PROM.

However, other purchases were also required in order to get your Apple I operating. These totaled \$122.00 and included: an ASCII keyboard, a video monitor (if you didn't use your own TV set), and two transformers. If you did use your own television, a simple modifica-

tion was required like a Pixe-verter or switch box and an rf modulator. In order to store programs, a two inch high cassette interface (ACI) was also available which came fully assembled and burned-in with a tape of APPLE BASIC for \$75.00. Jobs and Wozniak both agreed



APPLE - 1 OPERATION MANUAL

APPLE COMPUTER COMPANY
770 Welch Road
Palo Alto, Calif. 94304

that BASIC at this time was the language of the people because it was easy to use.

In 1977, Apple I advertisements claimed that, "unlike many other cassette boards on the marketplace, ours works every time." So if you also bought a tape recorder you were in luck because the Apple I worked reliably with almost any inexpensive audio-grade cassette recorder. Your total cost for the machine, \$903.66.

Relatively few Apple I's were sold compared to personal computers on the market today. However, the Apple I gained enough popularity because it was essentially "hassle free" and could be purchased for under \$1,000. Hobbyists, home computing novices and the computer store dealers themselves applauded its reliability.

It was this microcomputer, the Apple I that enabled Apple Computer, Inc. to quickly turn from a small, single-

product private company to the multi-product, multi-national, public company that it is today. As the Apple I's sales increased in 1977, Jobs and Wozniak began to spend much time perfecting the design of the Apple I and their future product the Apple II. But as the company bloomed, it was necessary for Jobs and Wozniak to go to the outside for help.

They recruited A.C. Markkula who had been marketing manager at Intel. He was fascinated with what both Jobs and Wozniak had already accomplished. To show his confidence in the duo he put up \$91,000, secured a credit line, and then found \$600,000 from other venture capitalists to help put Apple Computer Company on its feet. Shortly after, in May 1977, Markkula became chairman of the board, and Michael Scott, who took a 50 percent pay cut to join Apple from National Semiconductor became the company's first president.

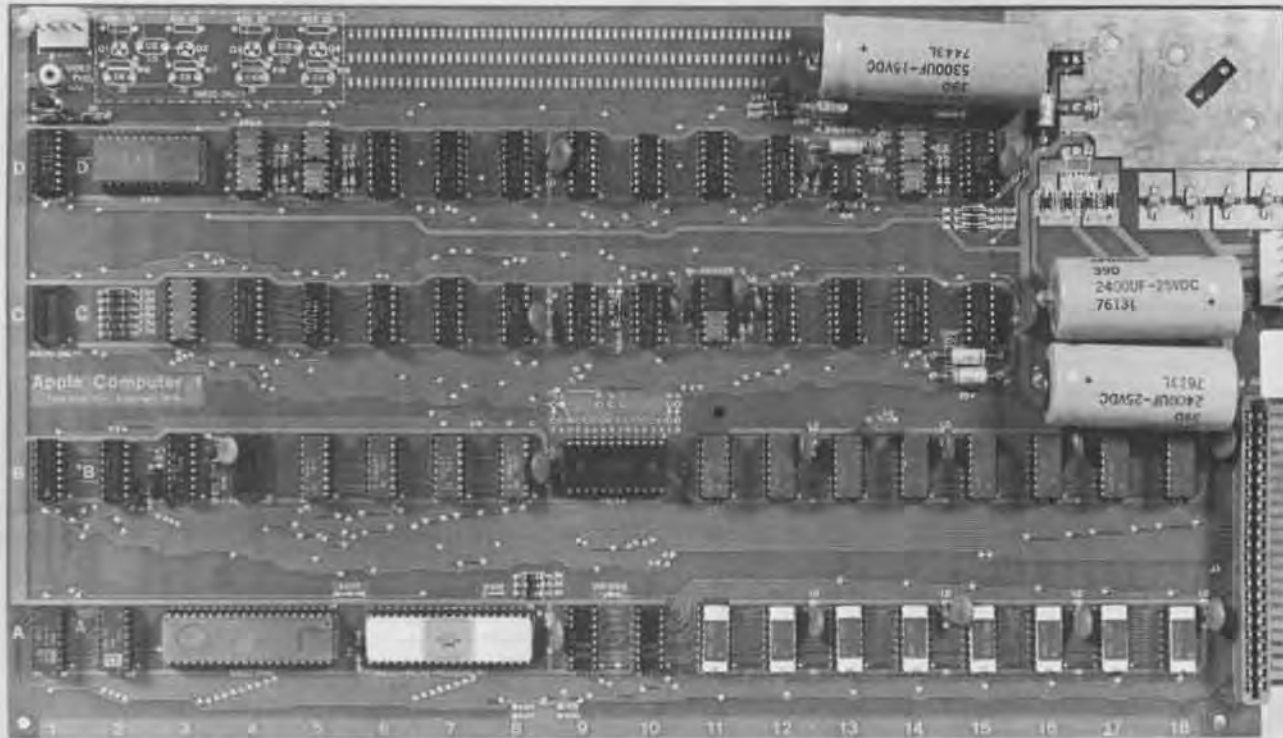

The Apple I. This Apple I board will be part of the Museum's Personal Computer exhibit opening November 14, 1984. Apple Computer, Inc. co-founders Steven P. Jobs and Stephen G. Wozniak

designed the Apple I in 1975 to meet the requirements of computer hobbyists. Priced at \$666.66, it met their needs as an easy-to-use computer system that was inexpensive.

Pre-Preview Party

The Computer Museum held a Pre-Preview Party on May 11 at its new location in downtown Boston. The festive evening commenced with a talk on the invention of the integrated circuit by

Intel founder Dr. Robert N. Noyce. Dancing and a screening of the film "Metropolis" followed dinner for party guests from industry and Museum Members.

Pre-Preview Party Lecture. Talking on the invention of the integrated circuit, Intel's Dr. Robert N. Noyce recalled,



"When I was in college, I could slave over something, finally get the right answer, hand in my paper and it would come back with these big red markings on it. My physics professor would say I did it the hard way. Then he'd jot down a couple of sentences which clearly made it much easier for me by using some other method. I guess that is what stuck with me, because one of the characteristics of an inventor I think is that he is lazy and doesn't like to do it the hard way."

Pre-Preview Party!

Ascending to the sixth floor. Attendees at The Computer Museum's May 11 Pre-Preview Party climb the new central stairway between the fifth and sixth floors. The stairway was completed just days before the party. The \$100 benefit dinner kicked off The Computer Museum's \$10,000,000 capital campaign.

Multiwire machine. Barbara T. Mastro and Curtis P. Hoffman familiarize themselves with a recent gift to the Museum from Kollmorgen's PCK Technology Division during the Pre-Preview Party. The Multiwire machine can "write" wire pat-



terns at rates of 100 inches per minute making it possible to reduce the size of computers.



Computing Relic. Talking by the 1958 SAGE display console are Peter Hirshberg (left) and Michael Poe. The console is part of the SAGE, the U.S. air defense computer that could use a light gun to track down enemy bombers.





Admiring the SAGE's duplex maintenance console during the pre-preview of the Museum's new 55,000-square-foot facilities in downtown Boston are Mr. and Mrs. Strump.

Janice Stone and Ned Forrester examine the core memory stack from the Whirlwind, an early vacuum tube



computer developed at MIT. Forrester's father Jay W. Forrester directed the design of the computer which was the first to use magnetic core memory.



The mini-museum. Stephanie Haack, (right center) communications director at The Computer Museum explains to party guests the concept behind the Museum's 20,000 square feet of exhibits scheduled to open on November 14.



Greetings. Mr. and Mrs. Phillip Pyburn meet a unique guest, "Shakey," the first fully-mobile robot with artificial intelligence, 1969, at The Computer Museum's Pre-Preview Party. The collection browsing followed Dr. Robert N. Noyce's talk on the invention of the integrated circuit.

IBM System/360 in Conclusion

Dear Editor:

I've enjoyed reading the *Computer Museum Report* for the past few months. It's good to see that people are preserving the older computers so that others will have an understanding of the family tree of today's Apples and IBM PCs.

Your note in "The End Bit" in Volume 9 noted that the MITS Altair was the first computer to use cassette tape as auxiliary memory. I don't think this is correct. I remember using several PDP-8 mini-computers in the 1971-1973 period and an 8-track audio cassette was used to save programs. The cassette unit was manufactured by Tennecomp and I think it was basically the type of cassette or cartridge system used by radio stations for advertisements or other short messages. It was an endless loop cassette and worked quite well. We had many programs stored on it and it was much, much easier than loading (and reloading) paper tapes.

There were several other microcomputer-based computers available to hobbyists and experimenters prior to the MITS Altair. One of the better known units was the Mark-8, an 8008-based computer that I designed and that was described in *Radio-Electronics* magazine in July 1974. After being available for several months, a group of experi-

menters in the Denver area came up with a modem board that allowed an audio cassette recorder to be used for program storage. This group eventually formed themselves into the Digital Group, which manufactured several types of computers. I think they were the first ones to use an audio cassette for storage of programs as modem tones.

I have a packet of information that the Digital Group published and distributed. It is undated, but I recall that it was put out in late 1974 or early 1975. It includes a schematic of the modem used for the cassette storage. The modem was made available prior to the publication of this technical information. The modem board is small, measuring 4½ by 2 inches.

There may have been other systems that used a cassette recorder for data and program storage at about this time. I know that Scelbi Computer Consulting, Milford, CT put together an 8008-based computer but I don't know if it had a cassette add-on. The early documentation I have does not show one.

With best wishes,
THE BLACKSBURG GROUP, INC.
Jonathan A. Titus, Ph.D.
President

In the Spring issue of *The Computer Museum Report*, Number 9 the Museum printed a transcript of a lecture on the IBM System/360 given by Bob O. Evans, IBM vice-president of engineering, programming and technology. The conclusion was inadvertently left out. It follows:

Immediately other companies thought they had been damaged too and filed their own law suits—TransAmerica, Memorex, Calcomp, and others. So, with much senior management and lawyers time expended, IBM went through the gauntlet of several anti-trust trials. That story is over for now, and I hope forever. We won every case on the merits and, recently, the last one, the TransAmerica case went to the Supreme Court which refused to hear it, thus upholding the lower court's decision. And a little over a year ago, the government dropped their anti-trust suit as being without merit. So that enormous weight has been lifted and we are back to getting on with life.

Yet the debate goes on that, had we not standardized and designed the System/360, we would not have had these kinds of copies, and we would not have had those lawsuits, and thus would not have had such difficulties. Thus, was it all worth it?

Of course my bias is that the driver of our products is the end user, and we have an accountability to that user. We also have an accountability to conduct ourselves in an ethical manner. Overall I believe devotedly the 360 decision was the right decision.

I can tell you that if I were faced with that decision today, we would make the 360 decision again, although I am certain it would be much tougher these days.

The net is: System/360 was conceived, born of a need, weathered a lot of tough gauntlets and went on to be a success for IBM and to be a significant part of the computer industry.

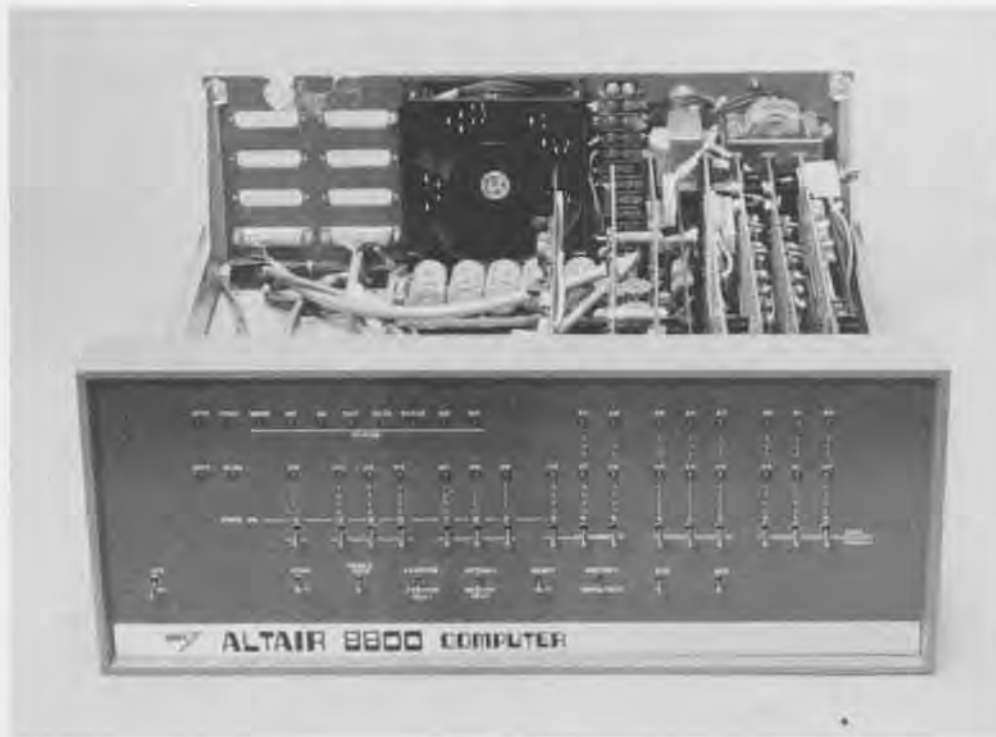

Museum Offers New Membership Categories

To celebrate its fall opening, the Museum is offering new membership categories and benefits for individuals and corporations. All individual members receive: a 10% discount on catalog purchases, a year's subscription to the Museum's quarterly magazine, invitations to openings, free admission to the Museum, notification of events, priority admission to special lectures and full library privileges with access to the Museum's extensive print and video archives.

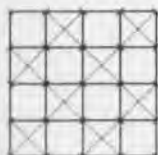

Please send this coupon and your check, money order, or charge information to:

Jana Buchholz
Membership Coordinator
The Computer Museum
300 Congress Street
Boston, MA 02210

All memberships and donations are tax-deductible within the limits provided by law.

Check the appropriate membership category:

- Individual Member \$30
All benefits listed above.
- Double Member \$40
Individual benefits for two people at the same address.
- Participating Member \$100
Invitations to two "meet the speaker" receptions following major lectures plus Double Member benefits.
- Micro Patron \$250
Recognition in the Museum Report plus Participating Member benefits.
- Mini Patron \$500
A guided tour of the Museum by the Director plus Micro Patron benefits.
- Mainframe Patron \$1000
Mainframe Patrons receive an original, signed computer generated drawing by artist Harold Cohen plus Mini Patron benefits.
- Super Patron \$5000
Recognition in the Museum as a "core contributor to the capital campaign and Mainframe Patron benefits.

Name _____
 Address _____
 City/Town _____
 State _____ Zip _____

Gift Membership from:
 Name _____
 Address _____
 City/Town _____
 State _____ Zip _____

Enclosed is a check or money order
 Please Charge my membership to:
 Visa MasterCard Amex
 Number _____
 Expiration _____
 Signature _____

Corporate Memberships

For information concerning corporate membership contact Michael Oleksiw, Development Director. New corporate benefits include free admission tickets for employees, rental privileges of Museum facilities, and eligibility to participate in the Museum's Collection Loan program.

Museum Hours

On Wednesday November 14, when the Museum opens its doors to the public at Museum Wharf in downtown Boston the hours will be: 11 a.m. to 6 p.m. Wednesday, Saturday and Sunday and 11 a.m. to 9 p.m. Thursday and Friday. It will be closed Mondays, Tuesdays, Christmas, New Years and Thanksgiving.

Upcoming Events

- November**
 November 7—Members Association Meeting, 7 p.m.
 November 13—Member's Preview
 November 14—Public Opening
- December**
 December 5—Members Association Meeting, 7 p.m.
 December 13—Engelman lecture on Artificial Intelligence 7:30 p.m.
- January**
 January 2—Members Association Meeting, 7 p.m.

Catalog Corner

Original Modules. An educational and nostalgic collection of actual computer modules. Includes one each of the following: an IBM SMS module; a module from a PDP-8 an early Digital Equipment Corporation computer; a Control Data 6600 module of unusual "cord wood construction"; and a Philco 212 module from 1958. Modules and circuit boards may vary slightly.

To order a set of original modules send \$19.95 (\$1795 for Museum members) plus \$4.00 for shipping and handling to Mail Order Department, The Computer Museum Store, 300 Congress Street, Boston, MA 02210.

Please add 5% Massachusetts sales tax for all Massachusetts shipping destinations.

You may also order over the phone using MasterCard, Visa or American Express. Just call (617) 542-0476 from 10 a.m. to 6 p.m. EST.



Corporate Founders Adage, Inc. ADP, Inc. Almac Moving and Storage, Inc. American Federation of Information Processing Societies, Inc. Analogic Corporation Apollo Computer, Inc. Association for Computing Machinery Benton and Bowles Bolt, Beranek and Newman Boris Color Labs The British Computer Society Burroughs Corporation Cipriani Associates Clint Clemens Codenoll Technology Corporation Commodore Business Machines, Inc. Computer Science Press Control Data Corporation Convergent Technologies Coopers & Lybrand Data General Datapoint Corporation Dataproducts Corporation Digital Equipment Corporation Digital Equipment Computer Users Society Expoconsul International, Inc. Ford Motor Company Fujitsu America, Inc. Gaston Snow & Ely Bartlett General Systems Group Inc. Grinnell Systems Corporation GTE Data Services, Inc. Hardcopy-Seldin Publishing Hewlett-Packard Company Foundation The IEEE Computer Society Intel Corporation INTERLAN, Inc. International Business Machines Corp. International Data Group (formerly ComputerWorld) International Telephone and Telegraph Corp. Jung/Brannen Associates, Inc. Jung/Brannen Research & Development Group The Arthur D. Little Foundation Los Alamos National Laboratory MASSCOMP McGraw-Hill, Inc. MDB Systems, Inc. Microsystems Engineering Corp. MITRE Corporation MOCO, Inc. Motorola, Inc. National Semiconductor Corp. NEC Corporation OMNI Publications International Ltd. PCK Technology Division Polaroid Corporation Recording & Statistical Corporation Dick Reno Schlumberger Horizons, Inc. Share Inc. Software Results Corp. Sony Corporation of America SRI International Stratus Computer, Inc. Symbolics, Inc. Systems Concepts System Development Foundation Tobin Food Services Travelers Insurance Company Venture Founders Corporation Wang Laboratories, Inc. Xerox

The Computer Museum
Museum Wharf
300 Congress Street
Boston, Massachusetts 02210

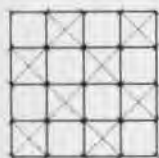

Non-Profit
Organization
U.S. Postage
PAID
Permit No. 110
Fitchburg, MA
01420



THE COMPUTER MUSEUM REPORT

WINTER 1984/85
VOLUME 11

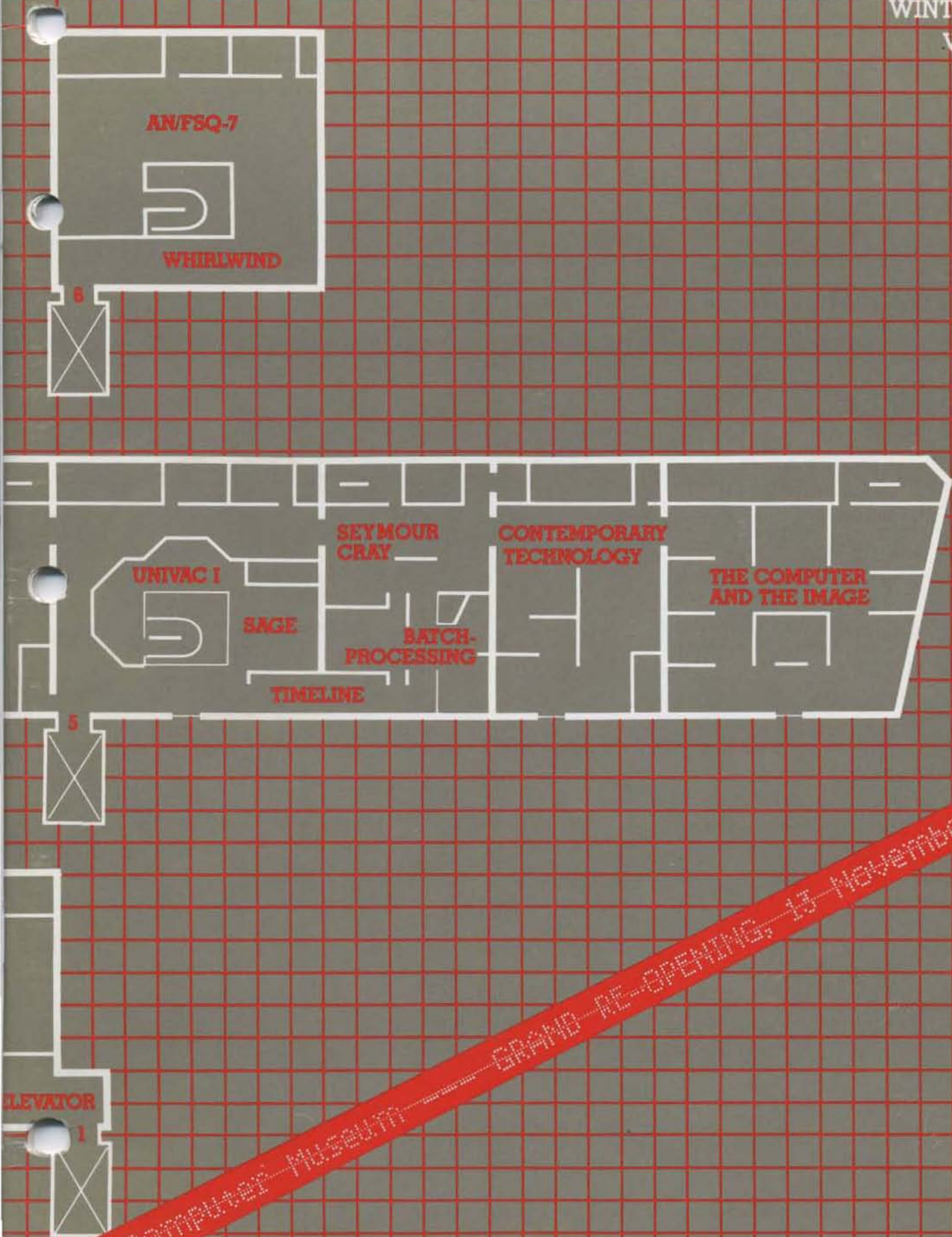

The Computer Museum GRAND RE-OPENING, 13 November 1984

Contents

1

The Director's Letter
Dr. Gwen Bell

4

Exhibits
Whirlwind
AN/FSQ-7 and SAGE
UNIVAC I
Timeline
Batch-Processing
Seymour Cray
Contemporary Technology
Computer and the Image

13

**The Integrated Circuit:
Origins and Impact**
Robert N. Noyce

16

**From The Computer
Museum Store**

17

**Spring Programs
Calendar**

Photo Credits:

Lou Goodman; pps. 5, 11
Jerry Rabinowitz; pps. 1, 5, 6, 7, 9, 10, 12
CBS; p. 6

THE COMPUTER MUSEUM

The Computer Museum is a non-profit 501(c)(3) foundation that chronicles the evolution of information processing through exhibitions, archives, publications, research, and programs.

It is conveniently located minutes from Logan International Airport and just a short walk from Boston's financial district and historic landmarks such as Faneuil Hall and the Freedom Trail.

Museum Hours: The Museum hours are 11 AM-6 PM, Wednesday, Saturday, and Sunday and 11 AM-9 PM, Thursday and Friday. It is closed Mondays, Tuesdays, Christmas, New Years, and Thanksgiving.

Museum Membership: The Museum offers both corporate and individual memberships; individual membership categories range from \$30.00 to \$4,095.00 and Corporate Membership from \$1,000 to \$10,000.

All members receive a membership card, free subscription to The Computer Museum Report, a 10% discount on merchandise from The Computer Museum Store, free admission and invitations to Museum previews. For more information, contact Jana Buchholz, Membership Coordinator at The Computer Museum, 300 Congress Street, Boston, MA 02210, (617) 426-2800.

1984 MEMBERS—\$250 or more

David Ahl, Mr. and Mrs. Roland B. Arndt, Isaac L. Auerbach, Robert W. Bailey, Ph.D., John Banning, Alan G. Bell, Gregory C.F. Bettice, Alfred M. Bertocchi, Allen H. Brady, Daniel S. Bricklin, Fred and Nancy Brooks, David A. Brown, Gordon S. Brown, Lawrence C. Brown, Marshall D. Butler, Charles T. and Virginia G. Casale, Donald Christiansen, Wesley A. Clark, Richard J. Clayton, George Towne Clifford, Howard E. Cox, Jr., Henry J. Crouse, David N. Cutler, Joe Cychosz, Gerald Davis and Francoise Saigetti, Clive B. Dawson, F. de Bros, Bruce A. and Frances M. Delagi, Jack Dennis, Nick de Wolf, L. John Doert, James R. Donaldson, Philip H. Dorn, Gregory L. Duckworth, Ray Duncan, Thomas Eggers, Dan L. Eisner, Bob O. Evans, Robert A. Farmer, Andrew D. Feit, Tse-yun Feng, Sidney Fernbach, Mark S. Fineman, Philip E. Fox, J. Thomas Franklin, Robert Friedman, Alan E. Frisbie, Lorrin Gale, Regina H. Garb, Donald H. George, Arthur W. Gottmann, Roger S. Gourd, John Griffith, Dr. Roberto Guatelli, Karl M. Guttag, Jerrier A. Haddad, William R. Hambrecht, Richard M. Haskins, Robert P. and Carol T. Henderson, Andreas Herberger, Robert B. Hoffman, M. Ernest Haber, Charles W. Johnson, Charles A. Jortberg, David W. Juers, Lawrence J. Kilgallen, Daniel Klien, Dr. Robert B. Kolstad, Marian J. Kowalski, Stanley Kugell, Raymond Kurzweil, John Levine, Michael Levitt, Joyce Currie Little, Carl Machover, Julius L. Marcus, Richard O. Mason, Joe W. Matthews, Tron McConnell, F. Warren McFarlan, Jim McIntosh, R. W. Meister, Robert C. Miller, Richard G. Mills, Thomas H. Moog, Dan Murray, Dr. and Mrs. Isaac R. Nassi, Stewart Nelson, Joseph Nestor, Joseph M. Newcomer, Chuck Newman, James N. O'Boyle, Jr., Anthony G. Oettinger, Lawrence and Paula Oliva, James V. and Martha M. Patton, Nicholas A. Pettinella, Linda J. Phillips, Paul R. Pierce, James A. Pitts, Trevor J. Porter, Kenneth F. Powell, Robert E. Ramsdell, Audrey R. Reith, Rex Rice, J. E. Richardson, William D. Ricker, Mark L. Robinson, David Rodgers, Ann and Robert Roe-Haler, Peter B. Rony, Jack Roseman, Jonathan Rotenberg, Martin S. Roth, Thomas S. Roy, II, Peter R. Samson, Edward A. Schwartz, James F. Shaughnessy, Jr., Richard B. Sims, John R. Spencer, John T. Stapleton, Max J. Steinmann, Howard Sussman, Michael G. Tomicic, G. Michael Uhler, Allan L. Wallack, J. T. West, W. S. West, Herbert E. Willman, Jr., Andrew Wilson

INDIVIDUAL CONTRIBUTORS TO CAPITAL CAMPAIGN —4K or more

Harlan E. and Lois Anderson
Charles and Constance Bachman
C. Gordon Bell
Alfred M. Bertocchi
Erich and Renee Bloch
Henry Burkhardt III
R. Steve Cheheyl
Robert C. and Eleanor W. Chinn
Robert G. Claussen
William Congleton
Alex d'Arbeloff
David Donaldson
Arnaud de Vitry
Douglas Drane

Robert Everett
Kenneth G. Fisher
Jay W. Forrester
Gardner Hendrie
Winston R. Hindle, Jr.
Theodore G. and Ruth T. Johnson
John Allen Jones
Mitchell Kapor
Allan Kent
Jack S. Kilby
Andrew C. Knowles, III
David J. A. Kogler
Edward and Debbie Kramer
John W. and Edna W. Lacey
Ralph and Linda Linsalata
John Norris Maguire
Richard D. Mailery
Thomas Marill
Daniel D. McCracken
James L. McKenney
Thomas and Elizabeth McWilliams
Carver Mead
Robert M. Metcalfe
Robert M. Morrill
David and Pat Nelson
Robert Noyce
Kenneth Olsen
Stanley C. Olsen
John L. Payne
Edward G. Perkins
John William Poduska
Fontaine K. Richardson
Douglas Ross
Jean E. Sammet
Alan F. Shugart
Richard L. Sites
Ronald G. Smart
Charles E. Spork
Ivan and Marcia Sutherland
Del Thorndike and Steve Teicher
Erwin Tomash
Stephen L. Watson
Harvey W. Wiggins, Jr.
William Wolston

1984 CORPORATE MEMBERS

BENEFACTOR—\$10,000

Apollo Computer, Inc.
BankAmerica Foundation*
Bank of Boston
Control Data Corporation*
Data General Corporation*
Digital Equipment Corporation*
Hewlett-Packard Foundation
International Data Group*
International Business Machines, Inc.
The MITRE Corporation*
Systems Development Foundation*
The Travelers Companies

PATRON—\$3,000

Addison-Wesley
AFIPS, Inc.
Analogic Corporation
British Computer Society
Burroughs Corporation
Commodore Business Machines, Inc.
Coopers & Lybrand
Datapoint Corporation
DECUS*
Draper Laboratories*
Expoconsul International
Gaston Snow & Ely Bartlett*
GTE Data Services, Inc.
IEEE Computer Society
INTERLAN, Inc.
Intel Corporation
ITT Corporation
Arthur D. Little, Inc.
Major Computer Incorporated
MASSCOMP
McGraw-Hill, Inc.
National Semiconductor Corporation
NEC Corporation
SHARE, Inc.
Software Results Corporation
Stratus Computer, Inc.
Symbolics, Inc.
Systems Concepts
Tobin Food Services
3Com Corporation*
Venture Founders Corporation
Wang Laboratories, Inc.
Xerox

CONTRIBUTOR—\$1,000

Analog Devices, Inc.
American Management Systems*
Computer Science Press
Ford Motor Company*
General Systems Group, Inc.*
Houghton Mifflin Company*
International Computer Ltd.*
Mediatech*
Microsoft*
New York Air*
Nolan, Norton & Company, Inc.*
Regis McKenna, Inc.*
ZBR Publications, Inc.

*Also Contributed to the Capital Campaign

BOARD OF DIRECTORS

John William Poduska, Sr., Chairman
Apollo Computer, Inc.

C. Gordon Bell
Encore Computer Corporation
Dr. Gwen Bell
The Computer Museum

Erich Bloch
National Science Foundation
Harvey D. Cragon
University of Texas, Austin

David Donaldson
Ropes and Gray

Robert Everett
The MITRE Corporation

Dr. Sydney Fernbach
Computer Consultant

C. Lester Hogan
Fairchild Camera and Instrument Corporation

Theodore G. Johnson

Mitchell Kapor
Lotus Development Corporation

Dr. Koji Kobayashi
NEC Corporation

John Lacey
Control Data Corporation

Patrick J. McGovern
CW Communications, Inc.

James L. McKenney
Harvard Business School

George Michael
Lawrence Livermore Laboratories

Dr. Arthur P. Molella
The National Museum of
American History,
Smithsonian Institution

Kenneth H. Olsen
Digital Equipment Corporation

Brian Randall
University of Newcastle upon Tyne

Jean E. Sammet
International Business Machines

Edward A. Schwartz
Digital Equipment Corporation

Kitty Selfridge
Henco Software, Inc.

Erwin Tomash
Dataproducts

Dr. An Wang
Wang Laboratories, Inc.

EXECUTIVE COMMITTEE

David Donaldson, Chairman, Gwen Bell, Theodore G. Johnson, Nicholas Pettinella, Jonathan Rotenberg, Kitty Selfridge, Ronald Smart, Oliver Strimpel

STAFF

Dr. Gwen Bell, Director

Dr. Oliver Strimpel,
Associate Director and Curator
Beth Parkhurst, Research Fellow; Andrew
Krstofly, Gregory Welch, Exhibit Developers;
Katherine Schwartz, Operations Manager;
Bill Wisheart, Registrar; Robert Carr, Kurt
Levitan, Floor Managers; Maise Zeller,
Communications and Programs
Coordinator.

Michael Oleksiw, Development Director
Jana Buchholz, Membership Coordinator;
Anne Jenckes, Development Assistant.

Eva Radding, Business Manager
Leo Cohen, Store Manager; Steve Klinka,
Assistant Store Manager; Debbie Goudrau,
Business Office Assistant; Sharon Kelly,
Functions Coordinator; Eileen Leavitt,
Receptionist.

Rossin Greenberg Serantek & Hill,
Advertising Consultants

Germain-Lawrence-DRK, Inc.,
Public Relations Advisors

**The
Computer
Museum**

300 Congress Street
Boston
Massachusetts
02210

The Director's Letter

It's great to be open again!

About 1500 people came to the opening on November 13th, including 100 from outside of Boston. Masateru Takagi, Vice President of NEC in Japan, traveled the longest distance to represent Dr. Kobayashi at this historic event.

The formal "ribbon cutting" was in keeping with the Museum. "Shag" Graetz, who worked night and day the last week to get the PDP-1 up and running, prepared the program that punched the paper tape reading "The Computer Museum Grand Re-Opening 13 November 1984." The students at Minuteman Technical High School then programmed an Apple II to control a robot arm that cut the 1960-era tape. The new exhibitions at the Museum range from vacuum-tube computing to the uses of the new personal computers, professional workstations, and computer networks.

The re-opening and re-birth of The Computer Museum took a long time in the making. Marlboro provided an excellent beta-test site for historic exhibits but gave us little experience about interactive computing within exhibits.

After the Board of Directors approved the move in May 1983, planning started immediately. A team of "developers" was put together. Dr. Oliver Strimpel, then Curator of Mathematics, Computing, and Navigation at The Science Museum, London, agreed to come as Visiting Curator and develop a highly interactive gallery devoted to computer graphics and image processing. At the completion of this work, Oliver agreed to stay on as the Curator of the Museum. Oliver subdivided the tasks in the image gallery with Geoffrey Dutton and Andrew Kristoffy as developers.

I undertook the role of curator of the rest of the exhibitions with "developers" for each segment: Paul Ceruzzi (who is now at the Air and Space Museum) on the 1950-69 Timeline; Beth Parkhurst on the integrated circuit and Apollo Guidance Computer exhibits; Carl Sprague on the "See It Then Theatre"; Meredith Stelling on the ANFS/Q7, SAGE, and UNIVAC exhibits; Gregory Welch on the IBM 1401 Room, Seymour Cray, and Manufacturing exhibits; and Bill Wisheart on the personal computer exhibit.



Ed Kuge, Gwen Bell, and Masateru Takagi from Tokyo with a souvenir tape.



Ted Johnson, Massachusetts Secretary of Commerce Evelyn Murphy, Minuteman Technical High School student and robot arm cutting the ribbon, Gordon Bell, Gwen Bell, Bill Poduska, and John Lacey.

Visitors at the opening at the close of the tape cutting ceremony.



Special thanks to Companies and Organizations who gave time, machines, programs, and materials to make the opening possible.

Adage, Inc.
Almac Moving & Storage
Altek Corporation
Apollo Computer, Inc.
Apple Computer, Inc.
Ariel Communications Corporation
AT&T
Bitstream, Inc.
Boeing Commercial Airplane Company
Boris Color Laboratories
CADCentre, Ltd.
Capitol Children's Museum
C-Ware Corporation
Commodore Business Machines, Inc.
Compaq Computer Corporation
Concord Caterers
Condor Corporation
Control Data Corporation
Coopers & Lybrand
Cranston Csuri Productions
Crissman and Soloman
Data General Corporation
Dataproducts Corporation
Digital Equipment Corporation
Digital Productions, Inc.
DUCK Productions
Fiber Optic Communications Specialists
Fibronics International, Inc.
General Computer Corporation
Germain-Lawrence-DRK, Inc.
Grinnell Systems Corporation
Hewlett-Packard Company
Institute of Advanced Study, Princeton University
Intel Corporation
International Business Machines Corporation
Interactive Computer Products
International Data Group
Jerry Valenta & Sons, Inc.
Jet Propulsion Laboratory
Jung/Brannen Associates, Inc.
Jung/Brannen R&D Group
KAYPRO Corporation
Lawrence Livermore National Laboratory
Learning Corporation of America
Lexidata Corporation
Lockheed Georgia Company
Los Alamos National Laboratory
Lucasfilm Ltd.
MASSCOMP
Mentor Graphics Corporation
Micro Control Systems, Inc.
Microsoft Corporation
Microsystems Engineering Corporation
Massachusetts Institute of Technology
MITRE Corporation
Mono Systems Corporation
NASA
National Museum of American History
National Museum of Science and Technology, Ottawa
National Semiconductor Corporation
NEC Corporation
Nike, Inc.
Northern Energy Homes
Omnibus Computer Graphics Center, Inc.
Ontario Science Center
Oregon Software, Inc.
Pencept, Inc.
Rand Corporation
Rassin Greenberg Seronick and Hill
Scriptel Corporation
Siecor Corporation
SIGGRAPH
Skidmore Owings & Merrill
SRI International
Summagraphics Corp.
Tektronix
Thayer School of Engineering, Dartmouth College
The Travelers Companies
United States Air Force
United States Geological Survey
University of Massachusetts at Amherst
University of Tokyo
University of Utah
VCA Teletronics
Visual Technology, Inc.
Wang Laboratories, Inc.
XtraSoft

Oliver, the developers and I then started to work with a broad set of advisors who helped us refine ideas, collect the materials and computers, and some of whom eventually worked on the actual programs and installations. The architectural firm of Crissman and Soloman were chosen to integrate the ideas of the developers with the existing structure of the 1880's wool warehouse and come up with suitable exhibition space. Meredith Stelling took on the role of supervising the contractors, Hawkins and Co., and the graphics designers, Maxwell Design.

When we worked out the schedule, all planning was to be complete by June 1, construction complete in early October, with a month for exhibit installation. It never worked that way. Everything happened at the end. And is still happening. When we opened with over half an acre of exhibits in five large rooms, each was about 70% complete. Over the winter, the exhibits will be finished and some will start to evolve even further as we watch how visitors are reacting.

By June 1, the developers had their scripts completed and then seriously sought to implement them. One exhibit that we knew we wanted to animate was on the Apollo Guidance Computer. Hewlett-Packard agreed to give us an HP-150 with a touch sensitive screen and the use of Tom Horth in their Andover facility as a consultant. Draper Laboratory's Malcolm Johnston coordinated the work of our summer intern, Andy Gerber, in order to accurately simulate the astronaut's console. But by July 1, the HP-150 had not appeared. Andy was more than ready to get started on the machine. Tom Horth came up with a loaner so that the project could begin in earnest. By mid-August the prototype program was tested and it was slow. Tom arranged to get us a faster compiler. Then, the actual machine came in September after Andy had gone back to MIT.

Another interactive exhibit that we wanted from the outset was one that communicated the concept of "discernability," conveying the meaning of pixel sizes, grey levels, and false coloring in image processing. Masscomp agreed to take on this exhibit. Lorrin Gale, Vice President of Engineering, personally made two trips to the Museum with several programmers. The project was specified and Masscomp produced a special two terminal machine. Each terminal was connected to a tv camera that they supplied. One camera is focussed on the face of the visitor, who then can change the pixel size and grey levels of his own image. The other camera is focussed on the view of Boston. The visitor can then color in the grey levels to create an "Andy Warhol-like painting." The engineers at Masscomp got excited about this project (one that has little hope of ever being a product) and kept assuring us that it would be exactly what we specified. Oliver visited it at the plant three days before opening and was satisfied. Masscomp delivered the two exhibits exactly one hour before the preview for the Board of Directors!

Last July, Oliver, Geoff Dutton and I went to SIGGRAPH, where, among other things, we collected "the teapot" from Martin Newell and got lines on other exhibit material. As I write this on New Year's Day, the "teapot" exhibit is not yet complete. Its components are numerous. Adage gave us a terminal connected via a fiber-optic cable, donated by Fibronics, to the VAX 750 contributed by Digital Equipment Corporation. The "teapot" simulation is still being programmed by Allan Sadoski, a volunteer from the Adage user group, and his 16-year old "hacker friend" Neil Day. They are spending most weekends at the Museum, providing a living, working exhibit. Parallel to this simulation, the Design and Production staff of The Children's Museum is building a stage set for the real teapot where its lighting can be manipulated manually. This should be complete in mid-winter.

IBM Fellow and Harvard Professor Benoit Mandelbrot became very excited about producing an interactive exhibit of his concept of fractals. He produced a program on the IBM XT but it lacked sufficient variation. A prolific author, he discovered, as we had, that an interactive exhibit needs to have a lot more variety than the illustrations within an article. A week prior to

Special thanks to the individuals who gave their time to make the opening possible.

opening, the program was finally acceptable but we had no machine to run on. Our two IBM XTs were committed to other programs. Dr. Mandelbrot arranged for another XT for this exhibit and it arrived (minus several critical parts) three days before the opening.

One exhibit that arrived complete and wonderful a full week before opening was a video of the view done by Dean Winkler and John Sanborn of VCA Teletronics. In August, they came up from New York and cavorted on top of the roof videotaping the view. They talked to us, looked at the logo and some of our concepts, and then spent over 200 midnight hours of editing with the very fancy frame-buffering equipment to produce a three-minute spectacular of the view popping out in different colors with the core plane logo flying over it and skyline circling a pyramid. In this case, the creators were given artistic freedom and went wild in making a very spectacular video. The equivalent spot made commercially would cost hundreds of thousands of dollars. Dean Winkler and John Sanborn will come up and explain to all how this was done in a talk on Sunday, March 17.

Yes, it's great to be open. Three "beta-test" talks were given in December, and now the full schedule of talks for the spring appears on the inside back cover. These are planned for every Thursday night at 7 and Sunday at 4 from February 7 to April 28. The next issue of the *Report* will have an article on one of the December talks—a conversation between Steve Levy and some of the heroes featured in his book *Hackers*. For those of you who can't get to the talks, we'll try to bring you the very best in the *Report*.

Best wishes for the New Year.



Frederick Ahrens	Marion Marill
Charles Bachman	Nelson Max
Constance Bachman	Benoit Mandelbrot
Steve Barbell	Norman Margolus
John Barstow	Salvatore Maulucci
Karma Beal	Patrick McGovern
Gordon Bell	James McKenney
Stephen Benton	Mary McKenney
Jim Blinn	John McKenzie
Loren Carpenter	Timothy McNeil
George Casaday	Carver Mead
Patrick Caulfield	George Michael
Kelly Chan	Armin Miller
Tom Charland	Richard Mueller
S. H. Chasen	Kent Multer
Pat Chavez	Robert Nathan
Duncan Chesley	Martin Newell
Robert Chinn	Jack Nolan
Robert Claussen	Robert Noyce
Harold Cohen	Charles Owen
Rob Cook	Michael Parker
David Corbishley	Ted Paull
Neil Day	John Payne
Vince Dirico	Jamie Pearson
John Doerr	Nicholas Pettinella
David Donaldson	Cliff Pitz
Greg Duckworth	William Poduska
Bill Dunbar	Tom Porter
Art Durinski	Ed Potter
Richard Eckhouse	Patrick Purcell
Greg Eggerton	Jerry Rabinowitz
Sonya Ellingson	Ed Ray
Ann Everett	Ron Resch
Robert Everett	Fontaine Richardson
Sydney Fernbach	Bill Ricker
Bruce Forbes	Catherine Riordan
Mary Jane Forbes	Ann Roe-Hafer
Karen Forte	Karin Rosenthal
Gene Frantz	Douglas Ross
Edward Fredkin	Charles Rossiter
Lorrin Gale	Richard Rubinstein
Edward Galvin	Ann Russell
Wendy Germain	Allan Sadoski
Steve Golson	Kay Saiz
Lou Goodman	Jean Sammet
Martin Graetz	John Sanborn
Sheila Grinnell	Stan Schultz
Eldon Hall	Kitty Selfridge
Skip Hammel	Scott Sitterly
Signe Hanson	Ronald Smart
Neal Hill	Alvy Ray Smith
Peter Hirschberg	Marcelline Smith
Francis Hjarne	John Spalvins
Richard Hofacker	Michael Spock
C. Lester Hogan	Jack Stevens
Tom Horth	Christopher Strangio
Robert Jerard	Howard Sussman
Theodore Johnson	Mike Sweeney
Malcolm Johnston	Regina Targhetta
Jean Jones	Steve Teicher
Charles Jortberg	Del Thorndike
Geoff Kalb	Tomaso Toffoli
Felice Katz	Erwin Tomash
Fred Kilmartin	Alar Toomre
Russell Kirsch	Greg Tutunjian
David Koogler	Gerard Vishniac
Alan Kotok	Richard Voss
Ted Kuklinski	Jon Ward
John Lacey	Steve Watson
Barth Lentini	Patrick Weidhaas
Ann Lewin	James Weider
Ralph Linsalata	David Weimer
Donald Lynn	Herbert Willman
Ian MacIennan	Dean Winkler
	Stephen Wolfram
	David Zeltzer

Whirlwind Entrance

The visitor enters into the Whirlwind computer—the first real-time stored program computer, so large that it took up a whole building. In a segment from a 1951 "See It Now" program, Edward R. Murrow interviews "the Whirlwind electronic computer". After he has Admiral Bolster give the "whirlwind its workout," Murrow says, "Well, I didn't understand the answer, and I didn't even understand the question." This seems really quaint to today's visitor because the whole program that the Admiral wants run on the

building full of Whirlwind, is running on a Compaq that was programmed by summer student.

This first exhibit illustrates the revolution, the unbelievable power of the first computers in the early fifties, and their incredible evolution in thirty-five years. The Whirlwind occupied a building, consumed 150 kilowatts and cost as much as \$20 million. The equivalent personal computer sits on a desk, plug into a wall socket, and costs two thousand dollars.



Entrance into the Museum puts the visitor in Whirlwind's arithmetic units, which occupied a whole room in the Barta Building at MIT. The 16 bit word length, extending 32 feet, was partially determined by the width of the room.

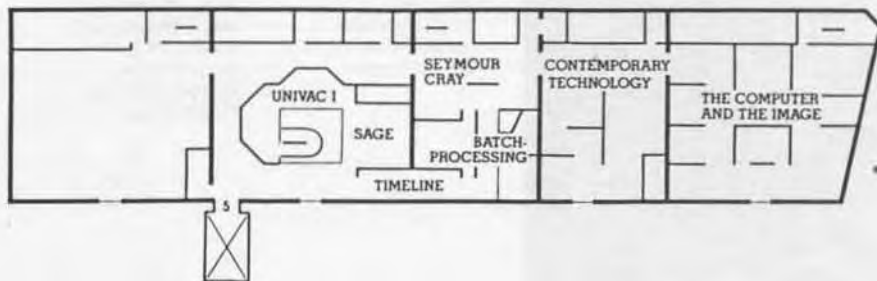

The AN/FSQ-7 and SAGE System

The Q7, a production version of Whirlwind, was probably the largest and longest lived computer in existence. It illustrates the computer components that are now on a single board or micro-chip.

The arithmetic and memory units with their 55,000 vacuum tubes took a very large space. The visitor can walk through the seven foot high banks of vacuum tubes and up to the four foot by four foot by eight foot 32-K core memory stack. The equivalent chips are exhibited and a terminal to the VAX provides a tutorial on how core memory works.

The control consoles were so large that they took up an entire room with several operators. The activities of the other components of the machine were shown in flashing lights on the consoles and the operator had a telephone to communicate with the people on the arithmetic, input-output units, or generator for the power.

The "Blue Room" consoles had large round screens that showed aircraft moving across the airspace. The screens were updated every 15 seconds by the Q7 causing a constant irritating flicker, hence a soft blue light in the room for the purpose of seeing the screen. The consoles display the air situation display and some were especially designed for weapons assignment or interception. The exhibit includes the consoles, chairs with their special drawers on the seats, and ceiling panels to recreate the feeling in the "Blue Room".

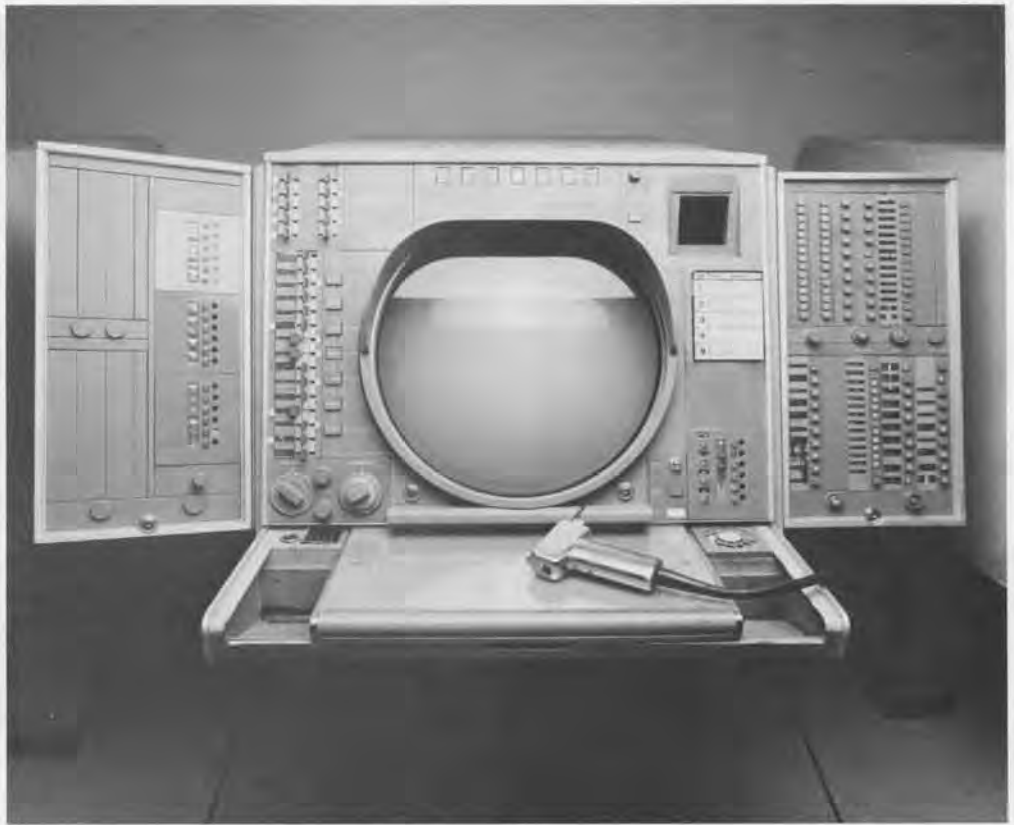

A console from the SAGE Blue Room, the control room for the SAGE, the U.S. air defense system from 1958-1983. Here, Computer Museum visitors can see the oversized video display terminals that served as the first computer graphics output devices that used light guns to identify the airplanes shown moving across the screen.



SAGE Blue Room.



Visitors walking through two rows of the AN/FSQ-7 arithmetic unit. Each computer had 55,000 vacuum tubes with 300 changed each week for preventive maintenance, whether they needed it or not.

UNIVAC I

Computing from 1950–1969: A Year by Year Timeline

After UNIVAC I was featured predicting the Eisenhower election of 1952, the name almost became synonymous with "computer." The video-tape and components of a UNIVAC I bring this era back to life.



J. Presper Eckert, Walter Cronkite and Charles Collingwood with the UNIVAC on election night in 1952. At 8:30 p.m., with only a few million votes tabulated, UNIVAC's first prediction showed a landslide victory for Eisenhower. Since nationwide polls had indicated a close race, Remington Rand officials revised the national trend factor and had UNIVAC recompute. At 9:15 p.m., UNIVAC publicly predicted 8 to 7 odds for Eisenhower. By 10:32 p.m., all predictions showed that Eisenhower would decisively beat Stevenson (442 to 89 electoral votes). The president of Remington Rand went on the air to explain why they had tampered with the original prediction.



The first two generations of computing are illustrated in a timeline with artifacts that move the visitor year-by-year over this twenty-year span. The invention of the transistor is at the beginning and the introduction of the NOVA, a third generation integrated circuit computer at the end. Unique artifacts, such as a unit from the EDSAC and the ILLIAC I, are complemented with illustrations of new technologies, applications, and ephemeral materials such as "Do not spindle" buttons.

The timeline is meant to be evocative of a walk through history. We hope that it will also bring to light many hitherto buried artifacts for preservation as part of the history of information processing.

Gordon Bell and Mass. Secretary of Commerce Evelyn Murphy looking at the early sixties section of the "Timeline." A module from the ILLIAC 2 hangs over an Olivetti Programma next to the teletype. Over 100 artifacts are included in this twenty-year timeline.

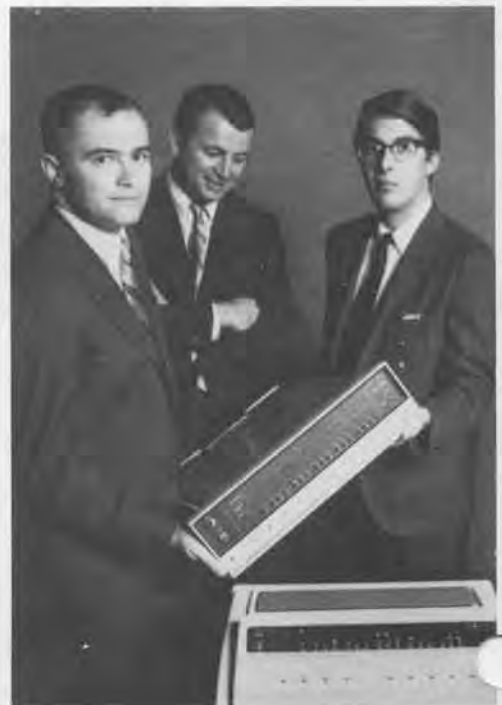

This picture of the 1969 Data General Nova and three of the company's founders, Edson de Castro, Herbert Richman, and Henry Burkhardt, ends the Timeline.

Batch-Processing in 1965:

An IBM 1401 Computer installed at The Travelers

The 1401 was the largest-selling transistorized computer. Its low price made it one of the machines which stimulated the tremendous rise in the business use of computers during the 1960's.

The exhibit is composed of three sections: the computer room, containing an IBM 1401 system; a card punch department, with an operating card punching machine which visitors can use; and a programmers office strewn with vintage programming paraphernalia.

The 1401 was designed in the mid-1950's to consolidate all of the various functions of IBM's electric punched card accounting machines; such as calculation, interpretation, collation and sorting of data. It operated on alphanumeric characters (letters and numbers) and used a variable word length. A unique feature of the 1401 was its add-to-storage feature which sped up calculation rates by eliminating the time taken for reading information from memory. The 1401 was basically intended as a card-based system, however, it was also able to use magnetic secondary memory in the form of either disc or tape.

IBM announced the 1401 in 1957 and delivered the first unit in 1958. Over 12,000 were ultimately installed. The success of the 1401 led to a small line of computers: the 1410, the 1440 and the 1460. The 1401 was the second-to-the-smallest of IBM's computers at the time. The scientifically-oriented 1620 was slightly smaller.

The principle use of the 1401 by Travelers was the generation of reports for management on information on policies issued. Information relating to policies, such as the name and address of the issuee, coverage, claims filed, etc. was stored on 80 column punched cards. Reports would be generated from these records according to a program directing which information was to be used and how, and how the result was to be presented. The speed and versatility of the 1401 permitted the condensation and manipulation of vast amounts of information into useable forms. This provided management with information about the trends in policies and claims allowing more informed decision-making.

The 1401 was a batch processing machine. Programs and data were fed to the computer one at a time exclusively by an operator. The programmer was isolated from the machine. This made the process of programming very difficult since the programmer rarely got his hands on the machine. Instead, he would encode the program he was writing, submit it to be punched from the code sheets onto 80 column cards, then have the cards delivered to the computer room with a batch of test data. The program would be run in between jobs. If it had a problem the operator would print out the contents of the memory and have them delivered back to the programmer, who would try to find his mistake and then start all over again. If the programmer was good friends with the

operator, he might be able to persuade him to let him de-bug his program on the machine late at night or some other time when the machine was not busy. Programmers "drove the operators crazy" and operators "drove the programmers crazy." A film in the "See It Then Theatre" entitled "Ellis D. Krupetehev and His Marvellous Timesharing Machine" illustrates batch processing and the change to timesharing.



A visitor punching a card in the 1401 computer exhibit area.



The IBM 1401 computer room recreated as it would have been in 1964 at an installation in The Travelers Companies. Francis Hjarne and Thomas Ottman of The Travelers provided the period ephemeral material, just as 1964 World's Fair posters and wall calendars to appropriately outfit the room. One of the only criticisms is that we don't have any period crumbled up candy bar wrappers on the floor—if anyone knows the whereabouts please send them to us and we'll add to the decor.

Focus on an Individual: Seymour Cray

"Seymour Cray is the most outstanding high-performance scientific computer designer in the world."

Gene Amdahl

Thus, it is appropriate that Cray is the first individual that is featured in this exhibit. The intent is to change the exhibition on a yearly basis, selecting people that represent various aspects of information processing: languages, applications, entrepreneurship, and even use.

The 33-year-long career of Seymour Cray illustrates the progress of computing. He has achieved this status through practicing a unique philosophy combining a small and isolated work force, with a simple logic and circuit design. His fame and self-imposed isolation have created an aura of myth around him. The exhibit traces Cray's career by means of a combination of artifacts, photographs, and a video tape of Cray giving a lecture.

Seymour Cray was born in 1927 in Chippewa Falls, Minnesota. The son of a city engineer, Seymour exhibited an interest in science in high school. After graduating in 1943, Cray entered the military where he worked repairing radios. After WW II he went on to earn his Bachelor's degree in electrical engineering at the University of Minnesota in 1950, and a Master's in Applied Mathematics a year later. One of his professors recalls how Cray "had the almost uncanny ability to see through all the possibilities . . . and arrive at the [best] solution."

In 1951, Cray went to work for Engineering Research Associates (ERA), a Saint Paul, Minnesota computer company founded in 1946. He was instrumental in the production of the ERA 1103, which, when it was announced on February 5, 1953, was one of the first commercially-available computer systems. After Remington Rand Company bought ERA, Cray stayed on as a principle designer of the unit computer of the Naval Tactical Data System (NTDS), a weapons control system designed under contract for the Navy. The first NTDS computers, completed in late 1957, were some of the first fully-transistorized computers. Serial number one of the heavily-armoured NTDS computers is on display in the exhibit.

According to Cray, "My story really starts with the beginning of Control



Data." In 1958 Cray left Remington Rand Univac to join a group of his former ERA colleagues who had formed Control Data Corporation. At Control Data, Cray commenced work on a low-cost, high-speed, powerful computer for scientific computation. To test the soundness of his logic and circuit design, Cray produced the Little Character. This machine, also on exhibit, served as the prototype for Control Data's first product, the 1604 computer system, named to represent its 16 thousand words of memory and 4 tape drives. Cray continued to pursue his inclination toward the design of large and fast systems for the forefront of computing.

On August 22, 1963 Control Data announced the 6600. This computer, designed by Cray, James E. Thornton and a handful of others in a remote laboratory which Cray had built in his home town of Chippewa Falls, was the most powerful computer of its time. It was three times faster than IBM's Stretch computer, yet a fraction of the size and cost. The 6600 exemplified many of Cray's design philosophies. For instance, its relatively small size reflects Cray's tenet that to make a computer fast one must make it compact. Half of a 6600 makes an impressive center-piece to the exhibit. On December 3, 1968 Control Data announced the successor to the 6600. The 7600 was 5 times faster than its prede-

Seymour Cray and John Rollwagon, President and Chairman of Cray Research, stand next to a prototype of the CRAY-2. To keep its components cool, the entire CPU will be immersed in inert fluorocarbon, the substance used for artificial blood.

cessor and cost only twice as much. A set of notes on the operation of the 7600 written by Cray is enshrined in a plexiglass case in the exhibit. It encapsulates many of Cray's design philosophies; earning it the nick-name "Seymour's Bible."

In 1972 Cray left Control Data to form his own company: Cray Research Incorporated. After four years of work, Cray Research delivered the Cray 1 to the Los Alamos National Laboratories in early March, 1976. Its radical design and \$8 million price tag led some to call it "the world's most expensive loveseat." A section of the Cray 1 is on exhibit at the Museum. Above it is a large image of the computer which was generated by a Cray 1 computer, illustrating the use of the large computers for graphics and entertainment applications as well as the large-scale number crunching.

Contemporary Technology

Starting with the Apollo Guidance Computer

The Apollo Guidance Computer, developed to guide spacecraft on their journey to the moon, represents the first use of integrated circuits in computers. Designed in 1962 and 1963, when only the operator got at the computer, the astronauts defined their own user-friendly console, "DSKY." An HP-150 with a touch sensitive screen reproduces the console so that visitors can "play astronaut."



The prototype Apollo Guidance Computer (1964) and Bill Poduska, Chairman of The Computer Museum and Apollo Computer Corporation.

The Manufacture of an Integrated Circuit Computer.

The manufacture of the Data General Eclipse C330 illustrates the complex series of processes which take place in making a whole computer from its raw components. The manufacture of a computer is in many ways analogous to the



final product. A series of parallel efforts, executed and coordinated on a broad scale culminate in a complete computer. The presentation includes photos, documents, and artifacts such as parts of or whole machines used in the process, and examples of the product and associated documents at each stage of development. At the end of the production line, a running Eclipse system provides the visitor with access to a data base from the International Data Group that enumerates the total of each different computer models produced year-by-year from the sixties to the present.

Personal Computers: Living and Dead

A burial mound of the first three generations of personal computers is surrounded by the latest models running a variety of programs with different input-output devices.

The 1962 LINC is the representative of the first generation. Built by the users at a special course at MIT, the LINC had keyboard input, graphic output, and was portable (it could be rolled down the hall.) The 1975 Altair with the original basic tape made by Bill Gates, the Xerox Alto, and the Apple I board are three of the classics in the next generation. The Apple II, Commodore Pet, TRS-80 and others in the third.

Presently, the operational computers were selected to illustrate the uses of various input-output devices, including a mouse, touch sensitive screen, keyboard, penpad, and voice output. These computers and their programs will be constantly changed and upgraded as new and more powerful machines are introduced. The burial mound will grow as a consequence. In addition, a documentation and software library is maintained behind the scenes.



A large part of computer manufacturing is not robotized, but people assemble, wire and test the components that make up a machine. This photo is from a Data General prototype assembly plant in Westborough, Massachusetts.

Visitors in the personal computer gallery.

The Computer and The Image

Computers' ability to manipulate and create images has changed radically in the last twenty years. Images take large amounts of memory to store, and correspondingly large amounts of computer time to process. Computer imaging of all kinds has benefitted directly from the steady decline in the cost of computer memory and processor cycles. Still most uses of computer graphics and image processing are confined to the workplace and research laboratory. For example, the animation possible on a personal computer is based on stick figures, in contrast to the 1984 two minute "cartoon" with three-dimensional figures made by Lucasfilm with the help of a Cray XMP and ten VAXes.

The image gallery both reflects the history of this application and provides a glimpse into the future. Many of the fruits of computer imaging are easily comprehended, yet are rarely seen in public. Those programs that run off the Museum's mainframes will undoubtedly be available one day on the individual workstation or home computer.

The gallery's frontispiece is a large Landsat mosaic spanning a 300 mile square region of Southern New England and New York. The image relied on digital techniques, both for its capture (there is no camera on Landsat, only an

instrument that measures the brightness of one point at a time) and for its enhancement and assembly.

This leads into a section on image processing. Working exhibits allow the visitor to degrade the resolution and number of shades of grey on a digital image of his/her own face and pan around a Landsat picture of eastern Massachusetts showing detail down to a scale of 30 meters.

On display is the first picture of another planet taken from a vantage point in space. The data was sent back by Mariner 4 during its 1965 Mars fly-by. While the data slowly emerged from the printer, the project scientists, eagerly awaiting their first closeup view of Mars, hand color-coded and stapled up the strips of printer paper. The result looks rather like a child's painting, but does reveal some Martian craters.

In the computer graphic technology section, two cases show graphic input and output devices. Rare items include the Rand Tablet and the crystal globe from MIT's "Kludge" terminal—one of the first geometric input devices. A video shows early graphics projects, from Ivan Sutherland's Sketchpad to the General Motors DAC-1, one of the first uses of computers in industrial design.

Several exhibits use the fine view



Andrew Kristoffy, Research Assistant for the gallery, first took a picture of his face. Then after it is stored in the computer, he can color each grey level differently to achieve an "Andy Warhol" look or begin to understand coloring of grey levels in order to bring out particular aspects of any image.



Associate Director and Curator of The Computer Museum, Dr. Oliver B.R. Strimpel, and Harvard University professor, Dr. Benoit B. Mandelbrot, also an IBM Fellow at the Thomas J. Watson Research Center, are shown standing with "Fractal Planetrise," an artificial computer generated landscape in "The Computer and the Image," a major gallery at The Computer Museum. Fractals are mathematical objects developed by Dr. Mandelbrot and have been used as models of natural phenomena such as turbulent fluid flow and the shapes of rivers and coastlines. Fractals have recently played a role in the synthesis of artificial landscapes for the film industry.

of downtown Boston from the gallery window as a starting point: a television camera captures an image for the visitor to color in digitally, a plotter continuously draws differently colored and shaded views, and a video shows both a walk through a 3-dimensional database of the city as well as an exhilarating range of special effects applied to stretch a 2-dimensional version of the view into "2½" dimensions.

The techniques of realistic image synthesis are shown in the section, Building an Image. Lighting, subtle color shading, the simulation of texture, transparency, reflections, and refractions of light are all shown. For many years, researchers in computer graphic realism used the data set that graphically reproduced Martin Newell's teapot to test their methods. The original teapot is now on show here in a mini stage set, next to a computer generated rendering of itself, complete with artificial colored lights. Here too you can browse through 3-dimensional computer models of houses on offer by a commercial builder.

A section on computer-aided design shows images and objects designed with the help of a machine. Examples range from parts of a Boeing 757 to an Olympic running shoe. At interactive stations visitors can design a car and complete the design of an electrical circuit. A large high precision pen plotter draws the artwork required to fabricate a microprocessor chip.

Interactive demonstrations allow the visitor to make his/her own fractals and cellular automata. Both are useful models of some natural phenomena, and rely on computer graphics for their investigation. Fractals are useful in generating artificial landscapes, several of which are shown here.

Color by Numbers! Using a mouse, the visitor can instantly re-color this land-



Pen plotter drawing the view from the gallery window programmed by Geoffrey Dutton for the HP 7586B connected to the VAX 750. The color and hatching denote properties such as distance,



height and type of object, and are varied between one plot and the next. The drawing consists of 185 polygons which were digitized by tracing over a photograph.

scape, selecting the season and then mixing the paint (the proportions of red,



blue, and yellow) desired for each of the objects.





Eiji Kuge of NEC uses the NEC PC to simulate a pantograph. A signed nineteenth century pantograph provides the backdrop for a contemporary model that allows the visitor to understand how this drawing instrument works. Then, the scale of the same drawing can be rapidly changed using the personal computer.

In a section entitled Simulation, a video shows examples from the modeling of galaxy collisions to the interaction of a DNA molecule with a drug. The fantasy world of SPACEWAR!, the first computer game written by MIT hackers on the DEC PDP-1 computer in 1962, is demonstrated on special occasions on the PDP-1, and otherwise runs on a modern micro. Visitors can also fly a Cessna using a flight simulation program. A video shows state-of-the-art use of graphics in flight simulation, landscape synthesis, education and advertising.

Perhaps the most appealing use of computer graphics is in the making of

films, both for animation and for the creation of convincing fictitious scenes. A computer animation theater shows a series of films from the earliest use of key frame inbetweening to the latest offering from Lucasfilm, completed in August 1984.

The visitor should be able to sense the excitement and challenges of this rapidly changing field in computer applications, as well as absorb many of its fundamental concepts. Much of the film, video material and working demonstrations will be updated to keep abreast of developments.



Martin "Shag" Graetz, who with Stanley Schultz and John McKenzie got the PDP-1 up and running with SpaceWar!, plays a game with a novice.

The Integrated Circuit: Origins and Impacts

Robert N. Noyce

As I was driving in tonight, I was listening to a Chrysler ad pointing out that the company was 60 years old. I think of Chrysler and the auto industry as old. Then, I thought, the semiconductor business must be reaching middle age, since it is now over 30.

In 1954, the semiconductor business amounted to 25 million dollars, the growth sequence then was 35, 80, 140, 210, 360, and then 550 million by 1960. Half the business was in transistors; silicon accounted for a relatively small share.

In the fifties, everyone was trying to figure out new and better ways of making transistors. At one of the solid state circuits conferences, an explorers kit, designed to keep you from getting lost in the woods, was displayed. It consisted of a box with a small cube of germanium and three pieces of wire. If you got lost, you were to start making a point contact transistor. Whereupon ten people would lean over your shoulder and say, "That's not the way to do it." Then, you would turn around and ask, "Where am I?"

At the time, germanium alloy transistors were made by putting indium on

top of semiconductor germanium and melting it just enough to dissolve some of the germanium and then recrystallizing it on both sides to make a PNP transistor.

One baffling research question was why germanium, when it was heated and then cooled in the laboratory, changed from N to P type. Simultaneously, transistors were being manufactured with N type germanium on the factory because the indium acted as a getter to pick up all the impurities instead of converting the germanium.

In the mid-fifties, the thinnest possible transistor was a fraction of a mil and a mil was a megacycle so these weren't very useful for anything except for hearing aids.

Between '54 and '55, we started worrying about diffusion as a way of getting impurities into the semiconductors, giving good control of the depth dimension. The problem was to get control of the other dimensions. Some of the first work was done at Philco because the semiconductor group worked right across the hall from the laboratory that was working on etching shadow mask tubes for color television. They were experienced with photo engraving, which turned out to work a lot better.

The invention of the planar transistor by Jean Hoerni further set the stage for the birth of the integrated circuit. Planar transistors solved the problem of impurities on the surface of the transistors and at their junctions that had been lousing up the specified characteristics. Hoerni's idea was to leave the silicon dioxide, a very good insulator, on top of the transistor when it was being diffused, thus forming a protective cover.

The government gave further impetus by their interest in getting things into smaller packages. The Air Force project Tinker Toy and the concept of molecular engineering didn't really work very well, but it did let everyone know that there was an interest in getting things small. A square inch chip with ten thousand transistors was very labor intensive: each transistor had to be attached by a couple of wires and soldered down. There had to be a smarter way.

I remembered that when I was in college, I could slave over something, finally get the right answer, hand in my paper and it would come back with big red markings on it. My physics professor

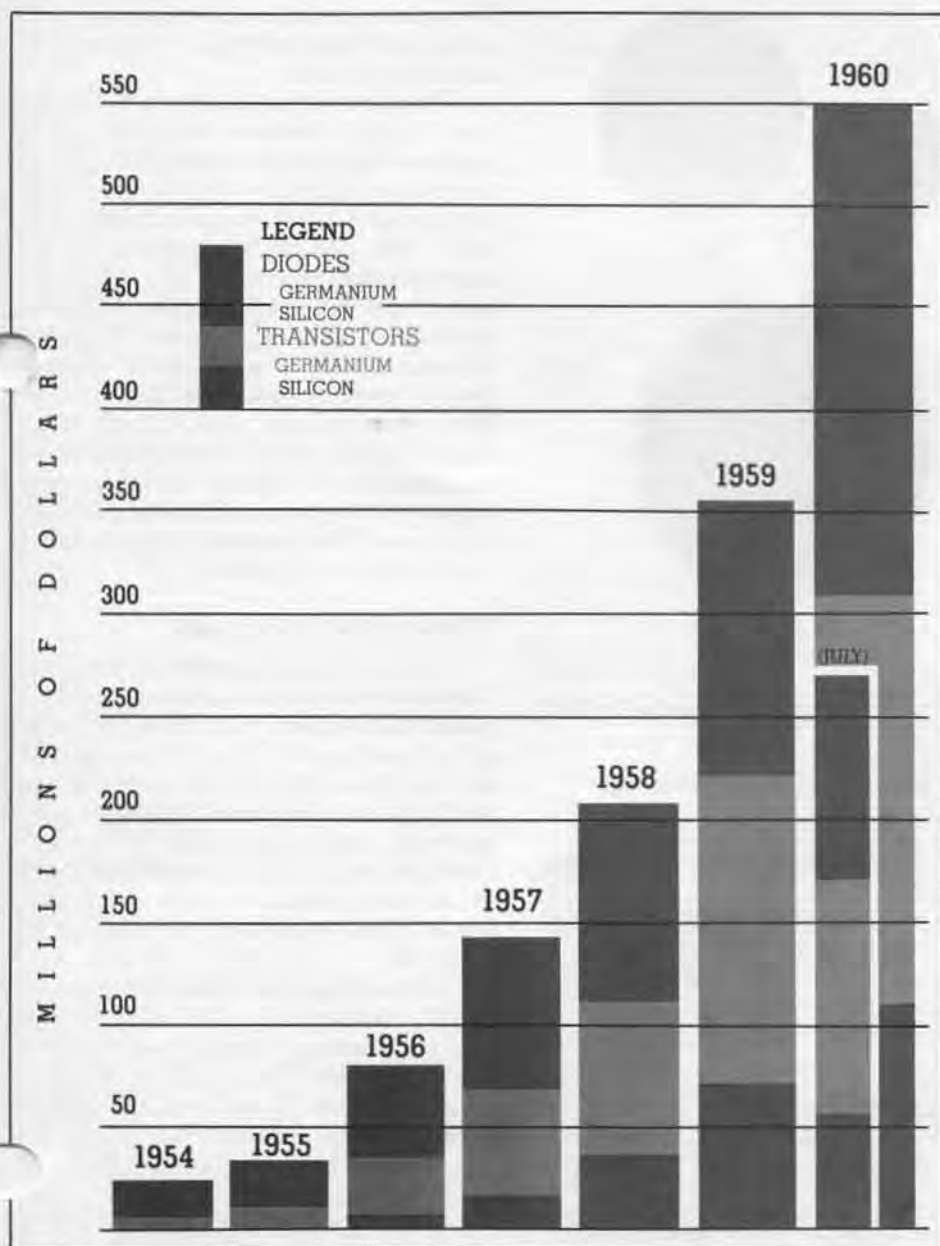

BREAKDOWN OF SEMICONDUCTOR MARKET

would say I did it the hard way. Then he'd jot down a couple of sentences which clearly made it much easier for me by using some other method. I guess that is what stuck with me because one of the characteristics of an inventor is that he is lazy and doesn't like to do it the hard way. Putting those 20,000 wires on 10,000 chips of silicon seemed like the hard way to me.

Although the printed circuit board was starting to be used, the thought of printing a circuit on top of the transistors had not occurred. It was the genesis of the idea of the integrated circuit. All the elements were converging: photo engraving enabled reproduction and the planar transistor allowed conductors directly on top of it. Three ideas popped up at that time. One was junction isolation, which I patented, even though it turned out that Kurt Lehovic had thought of it years before at Sprague. J. Last at Fairchild thought of the idea to etch the transistors apart, glue them down to something and if you still knew where they were you hopefully put them together. This idea had been previously patented at Bell Labs. The one I did get a patent on used intrinsic isolation, that is to use the silicon as an insulator. It didn't work well at first because by bombarding it with neutrons or doping it, leakage occurred and the life was too short. Junction isolation is now being broadly used.

After the original concept was developed, things moved very slowly. One reason was the low yield on transistors: with 50% yield and ten transistors together, the final yield of one over two to the tenth is a small number. We didn't even consider putting a thousand transistors together. Another problem was that the early integrated circuits were very slow. And, of course, the market was opposed to this innovation.

Progress followed the classic Moore's curve. Every year you could get something twice as complex as the year before. That extrapolates to a million elements in 1980. We didn't quite make that unless you allow for the introduction of new things like magnetic bubbles. The technology also changed from bi-polar to MOS.

Costs are determined by complexity and the number of leads per square inch of silicon with problems setting to 20,000. Starting with a 5/8th inch wafer in 1963, costs were reduced by increasing the size to 1 1/2 inch in '65 and two inches

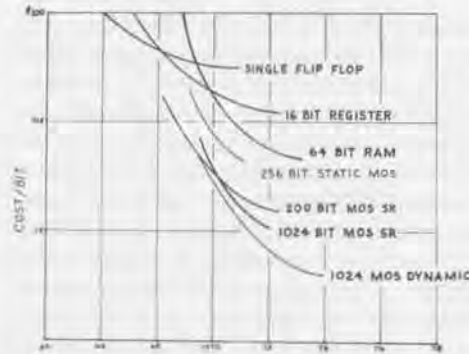

Cost of semiconductor memories.

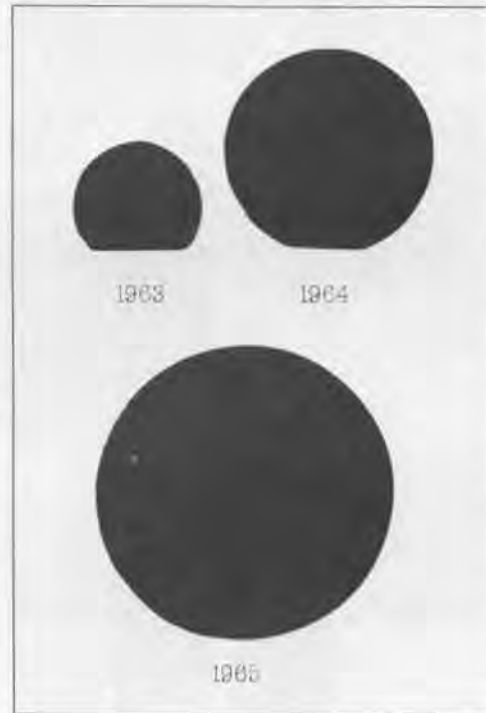

Increase in wafer size helped decrease costs.

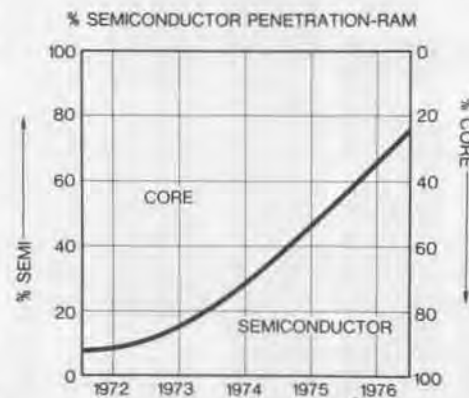

Prepared in 1974, my prediction that semiconductor random access memories would account for 80% of the market in 1977 was on target.

in 1970. The die size and area were also increased to reduce the density of defects that would kill the surface. It became possible to use an ever increasing area to put a circuit on and have it work. Circuit dimensions themselves have been reduced below the size of neurons, 10 microns, and these are being used for speech synthesizers and other products. Today, we have two micron circuits and are talking about .7 microns, so we indeed are getting down to biological dimensions and it is conceivable to talk about things the brain can do.

Other new ideas were important. One was MOS and the second was epitaxy. Prior to the use of epitaxy, only the surface could be more impure than the underlying material. This was another bag of tricks.

The first set of integrated circuits had straight Boolean functions. With progress the designers wanted complexity with lots of leads out of a circuit and the semiconductor manufacturers just didn't like that at all. In addition, the more complex products had a lower demand, and as manufacturers we were thinking of making millions of items. Simultaneously, the computer companies in the early seventies were talking about tens of thousands per year. One kind of chip, however, was like heroin to the computer designers and that was memory. Give them a little bit and they want more. Thus, memory chips became a major standard product.

What has the chip wrought?

The chip has been one of the main elements allowing the ubiquity of computers. Computers, as tools and devices to help train people to think logically and work precisely, have caused a major revolution in education, business, government, and all aspects of society. The telecommunications manufacturers would have us believe that every telephone in the world will be a computer terminal.

Some people fear this idea, just as I feared the telephone. One day, when I was quite young, my folks were out and left me alone. The telephone rang. I panicked, picked it up, and said, "Hello, nobody's home." Then hung it up. Today I can't imagine living without telephone.

Let me point out a couple of other changes that I've observed. The first computer in an automobile only controlled the non-skid brake and exhaust

Announcing a new era of integrated electronics



The microprocessor or microcomputer was introduced by Intel in 1971.

and it cost twice as much as the car and filled the whole trunk. In fact, the rear seat had to be used as well in order to install the computer. Today, computers in cars do ten times more work and cost only \$30. They are less expensive than a mechanical carburetor and will pay for itself in the first year in gas savings.

Jobs in the future are not going to require the skills of the past. One-hundred-and-fifty years ago, 50% of the American labor force was employed on the farm. Fifty years ago the greatest proportion was in manufacturing. Today that is about 20%. These latest statistics are inaccurate because the categories have not changed with the economy. Intel is included in the manufacturing sector, even though only 30% of our people actually touch any products that are shipped. Most of our employees sell, keep books, or even do such useful work as design the next generation of products. Today, more than 50% of the labor force is working with information.

The computer is the major tool that can help information workers. It's a productivity enhancer for people who work with ideas as well as for people who work with things. It will allow more human use of human beings. Dull repetitive tasks are the first to go. For example, retyping a letter for one mistake, or reformatting a marketing forecast.

The tradition of liberal arts education was designed to allow people to understand and communicate in society.

Grammar, rhetoric and logic came first, and then the quantitative studies of arithmetic, music with its geometrical relationships, geometry and astronomy followed. The same task is essential today. The student has new tools to help understand the continuing accelerating advances in technology. Most students will be working with a computer in some way.

It's not necessary for society to break down into C.P. Snow's two cultures in which those who do not work with technology are left behind those who have the modern tools to become productive. Despite the advances in technology, math, science and engineering are not attracting enough people in the U.S. The power of our computers that can help people as tools is growing beyond common imagination.

The Computer Museum has the CDC 6600, the first production supercomputer from 1963. It cost more than \$3 million and only had 500,000 transistors. That will be available on a single chip within a couple of years and everyone can have a supercomputer. All the educational institutions have a challenge to make this work for the science and liberal arts.

FROM THE COMPUTER MUSEUM STORE

Each quarter we will be using this space to offer special gift items and recommended titles to our membership and friends.

At long last! **The First Artificial Intelligence Coloring Book** by Harold Cohen, Becky Cohen and Penny Nii.

"Teach a computer how to draw? Artist Harold Cohen does just that. Find out how by eavesdropping on an illustrated conversation between the artist and an inquisitive pair of children, sharing with them stimulating ideas about decision-making, coloring, art, and the creative process in general.

"Intellectually and visually exciting, this book is for people of all ages who are curious about creating art with computers. With 35 computer-made drawings, ready to be colored and framed."

Cloth bound, 128 pages, 9" x 12".
Published by William Kaufmann, Inc.

On the occasion of a recent talk by the artist we asked him to autograph a limited number of copies of the book. We would like to offer these to you. \$21.95 (members \$19.95)



A charming gift book! **Sing a Song of Software** by Leonard J. Soltzberg.

"The first book of poems about computers, software, programs, and our complex love-hate relationship with them all. Thirty poems—illustrated with fascinating computer-generated graphics—capture both the frustration and excitement of the nerve-jangling, often funny, world of computers and computer people.

"These verses will draw a wry tinge of *deja vu* from computer professionals, will appeal to computer neophytes, and curious non-computer people who can all use the extensive glossary of computer terminology."

Published by William Kaufmann, Inc. Cloth bound, 7" x 7" (it looks just like a floppy!), 96 pages, \$9.95 (members \$8.95)

An insider's look at the quest for the intelligent machine! **The Cognitive Computer** by Roger C. Schank with Peter G. Childers. "This book describes the fascinating story of Professor Schank's search for the intelligent machine of tomorrow. It presents AI as an investigation into human understanding through which we learn not only about computers but about the complexities of our own intelligence. Schank's goal is to achieve cognitive understanding in computers—to create machines that will learn or change as a result of experience and be able to formulate new information.

"The cognitive computer of tomorrow will create a new computer revolution in which we all take part—and Roger Schank's research will have paved the way."

Published by Addison-Wesley. Hardcover, 6 1/4" x 9 1/4", 288 pages. \$17.95 (members \$16.15)

A best seller in The Museum Store! **Art and The Computer** by Melvin L. Prueitt.

"This book, with an introduction by Carl Sagan—written for both the novice and the professional—provides a report on some of the fine work being produced by artists using computers. It discusses problems in computer picture production, and explains how they have been solved. The book also demonstrates various methods of displaying scientific data and mathematical formulations that often turn out to be quite aesthetic."

Published by McGraw-Hill. Paperbound, 265 pages with 65 illustrations, 25 in full color. \$29.95 (members \$26.95)

Happy New Year! **The Computer Era 1985 Calendar** published for The Computer Museum in conjunction with Moco, Inc. A full-color, spiral bound, 13 month (December 84–December 85) calendar graphically illustrating robotics and artificial intelligence. It includes dates for 1985 scheduled computer conferences as well as important dates in computer history. Spread size: 12" x 18".

Originally \$6.95 each, now just \$4.95 each or two for \$6.95 (members \$4.45 each, two for \$6.25)



Special Offer to readers of The Computer Museum Report: For every Museum tote bag you purchase, we will include a sturdy and handsome diskette holder. Each diskette holder will store up to three 5 1/4" floppies safely and securely. Gray canvas tote with red core memory computer museum logo. Together a \$17.50 value. \$14.50 (members \$13.05)

Hard-to-find and Rare Books! For the collector, The Computer Museum Store offers a small, but select group, of both new and used hard to find titles. Almost

all are out of print. Availability varies and all are subject to prior sale. Please call the Museum Store for additional information. 617-426-2800 ext. 307.

ORDER FORM

NAME	DAY PHONE		
ADDRESS			
CITY	STATE	ZIP	

Method of Payment		Card Number	
Minimum charge order: \$15.00			
<input type="checkbox"/> Check or money order enclosed (no COD's)			
<input type="checkbox"/> Visa <input type="checkbox"/> Am Ex <input type="checkbox"/> Mastercard			
Interbank No.	(Mastercard only)		Signature
		Exp. date:	

QUAN.	DESCRIPTION	UNIT COST	TOTAL

Please add \$2.50 to cover postage & handling charges for the first item ordered; add 50¢ for each additional item.

Thank you. Your purchases help to support the museum.

SUBTOTAL	
MASS 5% TAX	
SHIPPING	
TOTAL ENCLOSED	

Spring 1985 Program Series

Thursdays at 7 p.m.

February 7

Mike Parker, President, Bitstream Inc.
*Typography for Image-makers:
Tools and Their Uses*

February 14

Benoit Mandelbrot & Richard Voss,
Harvard University and IBM
*Fractals: How to Imitate the Mountains and the Clouds
and Create Wild and Wonderful New Shapes*

February 17

There will be no program; Museum will be open.

February 21

Regis McKenna, President, Regis McKenna Inc.
Marketing Technology Companies in Changing Times

February 28

Steven Wolfram, Institute for Advanced Study,
Princeton University
Computation and the Complexity of Nature

March 7

Jan Rajchman, Vice President of
Research Information Sciences (retired), RCA
Memories 1945-1950: The Basis of the Modern Computer

March 14

Ed Fredkin, Chairman, Fredkin Enterprises S.A.
The Billiard Ball Model for Computation

March 21

There will be no program; Museum will be open.

March 28

Charles Bachman, President,
Bachman Information Systems, Inc.
Futures in Business Modeling Systems

April 4

Russell Nofsker, President, Symbolics
*Artificial Intelligence: From Software Concepts
to Hardware Architecture*

April 11

Dr. Norman G. Anderson and Dr. Leigh N. Anderson
Argonne National Laboratory
A Computerized Parts List for Man

April 18

Sherry Turkle, Massachusetts Institute of Technology
The Second Self: Computers and the Human Spirit

April 25

Alvy Ray Smith, Director of
Computer Graphics Research, Lucasfilm Ltd.
Computer Graphics in the Movies

Sundays at 4 p.m.

February 10

David Nelson, Vice President of
Research & Development, Apollo Computer
*From the First of the High Performance Workstations
to the Present*

February 17

There will be no program; Museum will be open.

February 24

Martin Graetz, Alan Kotok, and Steven Russell,
authors of SpaceWar!
The Making of the First Interactive Computer Video Game

March 3

Adam Osborne, President, Paperback Software International
Past, Present and Future

March 10

Keith Reid-Green, author of *Games Computers Play*
*A-Maze Your Friends! How to Generate
and Run Through Realistic Computer Mazes*

March 17

Dean M. Winkler, Sr. Design Engineer, VCA Teletronics;
& John Samborn, Video Artist & Director
*The Making of Renaissance:
Merging Computer Graphics and Video*

March 24

Alexander Schure, Chancellor, New York Institute of Technology
*Computer Graphics at NYIT: Outstanding films from one of the
world's leading Computer Graphics Centers*

March 31

Don Lynn, D.J. Lynn Associates
*Scientific Investigation of the Shroud of Turin:
An Image Processing Case History*

April 7

Easter: There will be no program; Museum will be open.

April 14

James F. Blinn, Computer Graphics Lab,
NASA Jet Propulsion Laboratory
The Rise and Fall of Realism in Computer Graphics

April 21

Stephen Benton, Massachusetts Institute of Technology
and Polaroid Corporation
Computer Holographics

April 28

Carver Mead, California Institute of Technology
*Archaeology of Electron Devices:
The Origins of the Silicon Compiler*

Join us for a series of informal and informative talks by the people who are making computing history - past, present and future.

All programs will take place in The Computer Museum Auditorium. Admission to the programs is free for Computer Museum members, and free to others with admission to the Museum: \$4 for adults; \$2 for students and senior citizens. Reserved seats are available to members by sending \$2 per seat per program to Majie Zeller,

Programs Coordinator, The Computer Museum, 300 Congress Street, Boston, MA 02210. Please make checks payable to The Computer Museum and clearly indicate which program(s) you plan to attend. Seats may also be reserved by paying \$2 at the door up to one half hour before the program begins.

Sponsored in part by grants from the Bank of Boston and Digital Equipment Corporation.

The Computer Museum



THE END BIT 0000000001

The Rand Tablet and Stylus, 1962

The Rand tablet was one of the first devices to allow freehand drawings to be input directly into a computer. Its pen-like stylus sensed pulses of electricity coursing through the tablet's fine grid of conductors, fixing a position to within a hundredth of an inch across the tablet's 11 inch square surface.

During the 1960's, the tablet was used for experiments in the input and machine recognition of handwritten roman and Chinese characters, as well as for interactive simulations, especially of biological systems. Many of these programs were written in GRAIL (graphical input language).

Donated by the Rand Corporation in 1984; on display in the gallery "The Computer and the Image."

Non-Profit
Organization
U.S. Postage
PAID
Permit No. 110
Fitchburg, MA
01420

The Computer Museum 300 Congress Street, Boston, Massachusetts 02210

ENTRANCE



MUSEUM STO

THE COMPUTER MUSEUM HISTORY CENTER



1 026 2147 1

THE COMPUTER MUSEUM REPORT

VOLUME 12

SPRING 1985



Howard Aiken and Lt. Grace Hopper

Contents

- 1
The Director's Letter
Dr. Gwen Bell
- 3
Howard Hathaway Aiken
The Life of a Computer Pioneer
Gregory W. Welch
- 13
A Conversation
with the Hackers
- 16
From The Computer
Museum Store
- 17
Program Series



BOARD OF DIRECTORS

John William Poduska, Sr., Chairman
Apollo Computer, Inc.
C. Gordon Bell
Encore Computer Corporation
Dr. Gwen Bell
The Computer Museum
Erich Bloch
National Science Foundation
Harvey D. Cragon
University of Texas, Austin
David Donaldson
Ropes and Gray
Robert Everett
The MITRE Corporation
Dr. Sydney Fernbach
Computer Consultant
C. Lester Hogan
Fairchild Camera and Instrument Corporation
Theodore G. Johnson
Mitchell Kapor
Lotus Development Corporation
Dr. Koji Kobayashi
NEC Corporation
John Lacey
Control Data Corporation
Patrick J. McGovern
CW Communications, Inc.
James L. McKenney
Harvard Business School
George Michael
Lawrence Livermore Laboratories
Dr. Arthur P. Molella
The National Museum of
American History,
Smithsonian Institution
Kenneth H. Olsen
Digital Equipment Corporation
Brian Randell
University of Newcastle upon Tyne
Jean E. Sammet
International Business Machines
Edward A. Schwartz
Digital Equipment Corporation
Kitty Selfridge
Henco Software, Inc.
Erwin Tomash
Dataproducts
Dr. An Wang
Wang Laboratories, Inc.

EXECUTIVE COMMITTEE

David Donaldson, Chairman; Gwen Bell,
Theodore G. Johnson, Nicholas Pettinella,
Jonathan Rotenberg, Kitty Selfridge, Ronald
Smart, Oliver Strimpel

STAFF

Dr. Gwen Bell, Director
Dr. Oliver Strimpel,
Associate Director and Curator
Beth Parkhurst, Research Fellow; Andrew
Kratofy, Gregory Welch, Exhibit Developers;
Katherine Schwartz, Operations Manager;
William Wisheart, Registrar; Robert Carr,
Kurt Levitan, Floor Managers.
Mark Hunt, Marketing Director
Majie Zeller, Public Relations Manager; Sharon
Baker Kelly, Functions Coordinator.
Michael Oleksiw, Development Director
Anne Jenckes, Development Assistant
Eva Radding, Business Manager
Lea Cohen, Store Manager; Steve Klinke,
Assistant Store Manager; Nancy Dattero, Office
Manager; Deborah Goudreau, Business
Office Assistant; Eileen Leavitt, Receptionist.

RossinGreenbergSeronick&Hill
Advertising Consultants
Germain-Lawrence-DRK, Inc.
Public Relations Advisors

CONTRIBUTING MEMBERS

David Ahl, Mr. and Mrs. Roland B. Arndt,
Isaac L. Auerbach, Robert W. Bailey, Ph.D.,
John Banning, Alan G. Bell, Gregory C. F.
Bettice, Alfred M. Bertocchi, Richard Billings,
Allen H. Brady, Daniel S. Bricklin, Fred and
Nancy Brooks, David A. Brown, Gordon S.
Brown, Lawrence C. Brown, Marshall D.
Butler, Charles T. and Virginia G. Casale,
Donald Christiansen, Richard J. Clayton,
George Towne Clifford, Howard E. Cox, Jr.,
Henry J. Crouse, David N. Cutler, Joe Cychosz,
Gerald Davis and Francoise Szigetti, Clive B.
Dawson, F. de Bros, Bruce A. and Frances M.
Delagi, Jack Dennis, Nick de Wolf, L. John
Doert, James R. Donaldson, Philip H. Dorn,
Gregory L. Duckworth, Ray Duncan, Thomas
Eggers, Dan L. Eisner, Bob O. Evans, Robert
A. Farmer, Andrew D. Feit, Tse-yun Feng,
Sidney Fernbach, Mark S. Fineman, Philip E.
Fox, J. Thomas Franklin, Robert Friedman,
Alan E. Frisbie, Lorrin Gale, Regina H. Garb,
Donald H. George, Arthur W. Gottmann,
Roger S. Gourd, John Griffith, Dr. Roberto
Guatelli, Karl M. Guttig, Jerrier A. Haddad,
William R. Hambrecht, Richard M. Haskins,
Robert P. and Carol T. Henderson, Andreas
Herberger, Robert B. Hoffman, M. Ernest
Huber, Charles W. Johnson, Charles A.
Jortberg, David W. Juers, Lawrence J.
Kilgallen, Daniel Klien, Dr. Robert B. Kolstad,
Marian J. Kowalski, Stanley Kugell, Raymond
Kurzweil, John Levine, Michael Levitt, Joyce
Currie Little, Carl Machover, Julius L. Marcus,
Richard O. Mason, Joe W. Matthews, Tron
McConnell, F. Warren McFarlan, Jim McIntosh,
R. W. Meister, Robert C. Miller, Richard G.
Mills, Thomas H. Moog, Dan Murray, Dr. and
Mrs. Isaac R. Nassi, Stewart Nelson, Joseph
Neator, Joseph M. Newcomer, Chuck Newman,
James N. O'Boyle, Jr., Anthony G. Oettinger,
Lawrence and Paula Oliva, James V. and
Martha M. Patton, Nicholas A. Pettinella,
Linda J. Phillips, Paul R. Pierce, James A.
Pitts, Trevor J. Porter, Kenneth F. Powell,
Robert E. Ramsdell, Audrey R. Reith, Rex
Rice, J. E. Richardson, William D. Ricker,
Mark L. Robinson, David Rodgers, Ann and
Robert Roe-Hafer, Peter R. Rony, Jack
Roseman, Jonathan Rotenberg, Martin S.
Roth, Thomas S. Roy, II, Peter R. Samson,
Edward A. Schwartz, James F. Shaughnessy,
Jr., Richard B. Sims, John R. Spencer, John T.
Stapleton, Max J. Steinmann, Howard
Sussman, Michael G. Tomicic, G. Michael
Uhler, Allan L. Wallack, J. T. West, W. S. West,
Herbert E. Willman, Jr., Andrew Wilson

CORE MEMBERS

Harlan E. and Lois Anderson
Charles and Constance Bachman
C. Gordon Bell
Alfred M. Bertocchi
Erich and Renee Bloch
Henry Burkhardt III
R. Steve Chehey
Robert C. and Eleanor W. Chinn
Robert G. Claussen
William Congleton
Alex d'Arbeloff
David Donaldson
Arnaud de Vitry
Douglas Drane
Robert Everett
Kenneth G. Fisher
Jay W. Forrester
Gardner Hendrie
Winston R. Hindle, Jr.
Theodore G. and Ruth T. Johnson
John Allen Jones
Mitchell Kapor
Allan Kent
Jack S. Kilby
August Klein
Andrew C. Knowles, III
David J. A. Koogler
Edward and Debbie Kramer
John W. and Edna W. Lacey
Raiph and Linda Linsalata
John Norris Maguire
Richard D. Mallery
Thomas Marill
Daniel D. McCracken
James L. McKenney
Thomas and Elizabeth McWilliams
Carver Mead
Robert M. Metcalfe
Robert M. Morrill
David and Pat Nelson
Robert Noyce
Kenneth Olsen
Stanley C. Olsen
John L. Payne
Edward G. Perkins
John William Poduska
Robert M. Price
Fontaine K. Richardson
Douglas Ross
Jean E. Sammet

Alan F. Shugart
Richard L. Sites
Ronald G. Smart
Charles E. Sporcik
Ivan and Marcia Sutherland
Del Thorndike and Steve Teicher
Erwin Tomash
Jean De Valpine
Charles P. Waite
Stephen L. Watson
Harvey W. Wiggins, Jr.
William Wolfson

CORPORATE MEMBERS

BENEFACTOR—\$10,000 or more

Apollo Computer, Inc.
Bank of America Foundation
Bank of Boston
The Boston Globe Foundation
Control Data Corporation
Data General Corporation
Digital Equipment Corporation
Hewlett-Packard
Honeywell Information Systems
International Data Group
International Business Machines, Inc.
The MITRE Corporation
Systems Development Foundation
The Travelers Companies
Wang Laboratories*

PATRON—\$3,000

Adage, Inc.
Addison-Wesley
AFIPS, Inc.
Analogic Corporation
Boris Color Lab, Inc.
British Computer Society
Burroughs Corporation
Commodore Business Machines, Inc.
Coopers & Lybrand
Datapoint Corporation
DECUS
Draper Laboratories
Expoconsul International
Gaston Snow & Ely Bartlett
GTE Data Services, Inc.
The Honeywell Foundation
IEEE Computer Society
INTERLAN, Inc.
Intel Corporation
ITT Corporation
Arthur D. Little, Inc.
MASSCOMP
McGraw-Hill, Inc.
Regis McKenna, Inc.
Mostek
National Semiconductor Corporation
NEC Corporation
The Prudential Foundation
SHARE, Inc.
Software Results Corporation
Stratus Computer, Inc.
Symbolics, Inc.
Systems Concepts
Tobin Food Services
3Com Corporation
Venture Founders Corporation
Wang Laboratories, Inc.
Xerox

CONTRIBUTOR—\$1,000

Analog Devices, Inc.
American Management Systems
Computer Science Press
The Cullinane Foundation
Dane, Falb, Stone & Co.
E. J. DuPont DeNemours & Co.
Ford Motor Company
General Systems Group, Inc.
Gould Inc. Foundation
Houghton Mifflin Company
International Computer Lid.
Investment Orange Nassau, Inc.
Manufacturers Hanover Trust
Meditech
Microsoft
Microsource Financial
New York Air
Nolan, Norton & Company, Inc.
Pencept, Inc.
Standard Oil Corporation
Teradyne
XRE Corporation
ZBR Publications, Inc.

*Also Contributed to the Capital Campaign

THE COMPUTER MUSEUM

The Computer Museum is a non-profit 501(c)3 foundation that chronicles the evolution of information processing through exhibitions, archives, publications, research, and programs.

It is conveniently located minutes from Logan International Airport and just a short walk from Boston's financial district and historic landmarks such as Faneuil Hall and the Freedom Trail.

Museum Hours: The Museum hours are 11 AM-6 PM, Wednesday, Saturday, and Sunday and 11 AM-9 PM, Thursday and Friday. It is closed Mondays, Tuesdays, Christmas, New Years, and Thanksgiving.

Museum Membership: The Museum offers both corporate and individual memberships; individual membership categories range from \$30.00 to \$4,096.00 and Corporate Membership from \$1,000 to \$10,000.

All members receive a membership card, free subscription to The Computer Museum Report, a 10% discount on merchandise from The Computer Museum Store, free admission and invitations to Museum previews. For more information, contact Membership Coordinator at The Computer Museum, 300 Congress Street, Boston, MA 02210. (617) 426-2800.

The Computer Museum
300 Congress Street
Boston
Massachusetts
02210

The Director's Letter

The relationship between a museum and its members is always an important one, but at The Computer Museum, I think it's very special. A variety of new projects and services are now underway that illustrate our unique association.

Many of the Museum's lectures are being made available to you on cassette tape. Chip Mann, a Museum member who heads up an organization called Power-sharing Inc., records those talks that are both interesting and appropriate for audio cassette (computer graphics presentations are not very good candidates for a purely audio tape) and is reproducing them for sale through The Computer Museum Store. The talks by Adam Osborne and Regis McKenna, now available, provide fascinating insights into contemporary marketing issues from totally different perspectives. The third tape now available, the story of how "Spacewar!" was developed at MIT, is also entertaining and instructive. For those of you who commute, these tapes are good alternatives to specialized news and talk shows. A regular subscription to the tapes can provide members with an "All Things Considered on Computing."

The Museum needs your valuable skills and talents as volunteers—not just at the Museum, but wherever you are. What kind of help does the Museum need?

Eyes and ears can let us know about appropriate additions to the collection, such as early personal computers, specialized calculators and slide rules, core memory stacks and planes (for a definitive collection), photos and films of people and machines.

Specialized programming for new interactive exhibits is a continual need. For example, a good p.c. simulation of a working IBM 1401 is on the wish list, as are simulations demonstrating why the Cray architecture is so fast, showing an election forecast, and other applications that illustrate the evolution of the industry. Here's an opportunity to do some programming just for the fun of it.

And, for those of you who are nearby, on-site volunteers to assist our interpreters in the galleries with visitors and to work behind-the-scenes would be a great help. At present, we have three very special such volunteers. Skip Hamel comes in almost every Thursday and Friday to help keep the exhibits in shape—adding, repairing and sprucing. Alan Sadowski, a member of the Adage Users group, and Neil Day, a high school junior, work many Friday nights and weekends programming the rendering of the "teapot" image processing exhibit. Without such help, the Museum would not be able to accomplish the tasks that are before us.

Special events, such as the May 3rd Benefit, also require volunteers. Susan Poduska, Chris Wilson, Fontaine Richardson, Wendy Germain, Jim Pompa, Maurice Dettman, Connie Bachman, Debbie Kramer, and Mary McKenney have signed on to make sure the party happens with flair and a positive cash flow for the Museum.

A second annual Computer Museum Attic Sale and Antique Show is being planned for Sunday, September 22. Some of the better items will be listed in the August Report so that members can participate in the sale from afar. Contributions for this are welcomed.

Some of our best ideas have come from you, the Museum members. Please let me know what can be done to make the Museum serve your needs and your goals for "the industry's attic and showcase."

Queen K Bell



*The young Howard Aiken.
(Photo courtesy of Mrs. Mary Aiken)*

Howard Hathaway Aiken

The Life of a Computer Pioneer

by Gregory W. Welch

On August 14, 1944, Thomas J. Watson, president of the International Business Machines Corporation (IBM), publicly presented Harvard University with the IBM Automatic Sequence Controlled Calculator (ASCC).¹ Top brass from IBM, Harvard, and the U.S. Navy addressed the assembled press corps. Six-page, glossy brochures describing the machine and its development were distributed. It was a grand occasion.

The ASCC represented a tremendous advance for science and industry. It was the result of a long, cooperative effort between IBM and Harvard, and was already proving its worth: the Navy was using the calculator in connection with World War II. The public announcement of this engineering feat heralded what is now termed the "Information Age." Press reports sparked the public's imagination to consider a world full of automatic machines performing tasks formerly delegated to man. Despite the many people involved with and affected by the ceremony, the moment belonged, more than to anyone else, to one man.

The Harvard Mark I, as the machine was commonly known, was the brainchild of 44-year-old Harvard physicist, Howard Hathaway Aiken. Aiken had given birth to the project eight years before while working on his Harvard Ph.D. thesis. He and many of his colleagues were confounded by mathematical problems which required an immense amount of calculations. The idea of a machine which would perform vast calculations automatically was appealing to them. Consequently, Aiken embarked on the design of such a machine. Although the ASCC had been operating around-the-clock for several months for the Navy in connection with the war effort, the August 14th ceremony officially recognized the fruition of his effort.

The Mark I was only the first in a series of machines which Aiken was instrumental in designing. It was followed by three successors: the Mark II, III, and IV. In addition to designing computers, Aiken worked to increase the facilities of the Harvard Computation Laboratories and to establish a cur-

riculum in information processing technology, both on a practical and a theoretical level. He also consulted for private industries and government agencies, travelled widely advocating international cooperation in the field of computing, and received many decorations for his work. Aiken worked to provide an environment in which computer science, indeed all sciences, could flourish. To appreciate his contributions one must examine the full scope of Aiken's work in the context of his life.

Howard Hathaway Aiken was born on March 8, 1900 in Hoboken, New Jersey.² While still a young boy, his family moved to Indianapolis, Indiana, where he attended grade school. His parents were of little means, and after his father's death, Howard had to work to help support his mother. When he finished grade school Aiken went to work for the Indianapolis Light and Heat Company as an electrician's helper. Eager to continue his education, he pursued a high school diploma through correspondence courses. Eventually, he was able to work the night shift and attend public school during the day. He received his diploma in 1919 from the Arsenal Technical High School in Indianapolis. The next year he was admitted to the University of Wisconsin in Madison to study electrical engineering. His experience as an electrician's helper came in handy in his academic work, and enabled him to find employment to pay for his schooling. While studying at the University of Wisconsin Aiken worked as the Watch Engineer on the night shift for the Madison Gas and Electric Company. In 1923 the University of Wisconsin awarded him a Bachelor's Degree of Science.³

Upon graduation from college, Aiken's career accelerated. The Madison Gas and Electric Company promoted him to the position of Engineer with the responsibility of redesigning and rebuilding the company's electric power plant. They next assigned him to oversee the construction of a 3-million-cubic-foot gas storage facility. Whether he became restless or his employers

could not keep him supplied with challenging projects is unclear. In 1926 Aiken moved on. He took employment with the Central Station Division of the Westinghouse Electric and Manufacturing Company where his tasks ranged from product application to power plant design. In 1928 he left Western Electric to become a District Manager for the Line Material Company of Detroit to seek ever greater challenges and responsibilities. However, he found, as many engineers discover, that he was moving further from the activities he enjoyed.⁴ Consequently, in 1931 he returned to school to study physics.

For a year he pursued a Ph.D. at the University of Chicago, but he found it to be "a lousy institution."⁵ The next year he moved to Cambridge, Massachusetts to enroll in the graduate program of Harvard's Division of Applied Physics and Applied Sciences. Aiken earned his M.S. in 1937, and his Ph.D. in 1939. His dissertation, "Theory of Space Charge Conductions," dealt with the properties of vacuum tubes—devices in which electric currents are passed across an empty space between two metal contacts. The mathematical complexities involved in describing space charge conduction made calculating solutions to his problems impossible.⁶ This diffi-



(Photo courtesy of Mrs. Mary Aiken)

culty led to Aiken's decision to build an automatic calculator.

From 1936 to 1937, Aiken became increasingly interested in automatic calculators. During a discussion with colleagues on the need for a powerful automatic calculator at Harvard, Professor Harlow Shapley, Director of the Harvard Observatory, informed Aiken of a project addressing these problems with IBM office machines at Columbia University.⁷ The IBM machines could perform simple mathematical operations (addition, subtraction, multiplication, and division) upon information encoded in holes punched on paper cards. These machines were controlled by "wired plug boards" that had to be rewired for each different calculation. The prospect of hooking together several such machines under a central automatic control unit to perform complex calculations intrigued Aiken. During the summer of 1937, he began investigating previous attempts to build mechanical aids to computation. He read about many efforts, from the earliest attempt at a mechanical calculator by the 17th-century mathematician, Blaise Pascal, to the contemporary differential analyzers and office calculators. Of all these efforts, Aiken was most interested in the work of the 19th-century Londoner, Charles Babbage.

Building on Babbage

In 1822 Babbage had built a machine called the Difference Engine for the calculation of mathematical tables. This machine was a mechanical device capable of calculating the values of a function with an accuracy of up to six digits. It did this by a method of successive additions. Upon completing the machine, Babbage successfully acquired, with the aid of his friend, the Duke of Wellington, a series of government grants totalling 12,000 English pounds.⁸ These grants were for the construction of a larger, more powerful Difference Engine, a machine capable of calculating tables, particularly for navigation, with an accuracy of 26 digits.⁹ However, this machine was never completed. Instead, Babbage became obsessed with producing an even more ambitious machine, the Analytic Engine. In a paper of December 26, 1837, "On the Mathematical Power of the Calculating Engine," Babbage described the organization of a machine which could perform general calculations under automatic control.

The described machine had the basic structure of a modern computer: a processor, a memory, and input and output devices. It was to have a "Mill," which would control the machine's operation and perform calculations according to instructions encoded on punched paper cards, a "Store" for saving information, and a printing device for the output of results. Babbage and his friend, Lady Ada Lovelace, daughter of poet Lord Byron, saw the vast potential for this machine to perform a wide variety of calculations independent of human intervention. Babbage's efforts to improve the machine's design never ceased. However, his dreams proved too advanced for the metal-working technology of his time. The machine was never completed.

Aiken saw the implications of Babbage's work, and his calculator partly reflected the design of Babbage's Analytic Engine. He also took Babbage's experience building the Analytic Engine to heart, and decided it would be best to build his calculator with components which were proven reliable. Consequently, his calculator used electromechanical components, rather than vacuum tubes. The culmination of his research was a paper, "Proposed Automatic Calculating Machine," written at the end of summer of 1937. In it he outlined the necessity for an automatic calculating machine, the attempts which previously had been made, the requirements for a useful machine, and mathematical proofs for meeting these requirements. Aiken noted, almost with irritation, "[a]t the present time there exist problems beyond our ability to solve, not because of theoretical difficulties, but because of insufficient means of mechanical computation."¹⁰

Proving His Theories

Aiken claimed that the punched card calculators manufactured by IBM were capable of all the necessary operations that an automatic calculator must perform to meet the needs of science. He outlined the capabilities: it would have to be able to add, subtract, multiply, and divide both positive and negative numbers many digits long, to group and order these operations by using parentheses and brackets; handle both integral and fractional powers of numbers; compute logarithms and antilogarithms in any base; compute trigonometric and antitrigonometric functions, hyperbolic

and antihyperbolic functions; and use several transcendental functions such as probability, elliptic, and Bessel functions. Aiken provided ingenious proofs of how all of these complex functions could be reduced to repetitive combinations of the four basic arithmetic operations. He also proved that a simple table of 100 numbers will allow all logarithms to be quickly calculated. Further, he proved that the sign of a number may be represented as a number, and temporary storage areas may be used to hold information while other calculations are proceeding so that parentheses can be used.¹¹

Having proved the small number of essential operations needed to perform all scientific calculations, Aiken turned to how an automatic calculator might be constructed. Since the IBM calculating machines of his day could perform the four basic mathematical operations, the problem amounted to expanding their capacity and providing a suitable method of automatically controlling their operation.¹² Although he did not specify the actual construction or operation of the machine, Aiken listed the principle components which it should contain: a power supply and electric motor for driving the machine; four master control panels, controlled by instructions on punched rolls of paper tape and synchronized with the rest of the machine; manual adjustments for controlling the calculation of functions; 24 sets of switches for entering numerical constants; 2 paper tape readers for entering additional constants; a standard punched card reader; 12 temporary storage units; 5 units each—add/subtract, multiply, divide; various permanent function tables (e.g. sine, cosine, etc.); accumulators; and printing and card punching equipment.¹³ All of these components should be built to accommodate figures up to 23-digits long. Finally, Aiken estimated the speed of the calculator based upon the speed of contemporary IBM machines, 750 8-digit multiplications per hour, representing a vast increase in speed and accuracy over manual methods of calculation.¹⁴

Aiken "visualized [the machine] as a switchboard on which are mounted various pieces of calculating machinery apparatus."¹⁵ Although he did not have the specific details of how the various components were to function together, the Mark I was ultimately very similar to the description in his proposal.

Convinced of the viability of building an automatic scientific calculator with existing technology and with proof in his manuscript, Aiken attempted to find a manufacturer who would build one. He approached many companies in the business of manufacturing mechanical calculators, such as Marchant, Monroe, and National Cash Register, but they expressed no interest.¹⁶ Furthermore, President James Bryant Conant of Harvard warned Aiken that he was risking a tenured position if he continued to pursue implausible schemes.¹⁷ Aiken persevered. Professor Shapley and Theodore H. Brown, Professor of Business Statistics at the Harvard Business School and consulting member of the IBM Department of Education, encouraged Aiken to approach IBM for support. In late 1937, Brown introduced Aiken to J. W. Bryce, "dean of IBM's scientists and inventors."¹⁸ Bryce was receptive to Aiken's proposal and sponsored its passage through the monolithic IBM bureaucracy. Thomas J. Watson agreed to build the automatic calculator and donate it to Harvard, if Aiken would work on the project.¹⁹

Off and Running

Aiken started by visiting IBM's Columbia University computation facility, where he saw IBM machines being used to perform scientific calculations—but not automatically. This helped him get acquainted with state-of-the-art IBM equipment. A cadre of IBM's top engineers was assigned to the project. The head of the team was C. D. Lake, a true mechanical genius. Under Lake were two other top-flight engineers, Frank E. Hamilton and Benjamin M. Durfee. Aiken and Bryce acted as administrators and overseers, while also taking part in designing of some of the components. These five men formed the central core of the Automatic Sequence Controlled Calculator (ASCC) project.

During the summers of 1938 and 1939, Aiken left Cambridge, where he lived with his wife Louise and daughter Rachael, and spent the season in Endicott working with the IBM engineers. What part he played in the design of the computer is unclear. Given the relatively small amount of time he spent in Endicott, and the large expertise of the other men (Bryce had over 400 patents in his name), he probably had a small hand in the design. However, he did work with Hamilton on the design of the



function tables for logs, sines, etc.²⁰ Many of the components incorporated in the calculator were, in fact, patented under the names of IBM engineers. For example, the multiplying and dividing was patented in 1937 by Bryce and another IBM engineer. Hamilton and Durfee designed the control circuitry.²¹ As the project progressed from the theoretical realm of design to the task of fabricating the calculator, Aiken had less direct involvement with it. Aiken later acknowledged IBM engineers Lake, Hamilton, and Durfee as co-inventors of the ASCC.²²

By late 1939 the design process had advanced enough that Aiken's intimate involvement with the project was no longer needed. He received his Ph.D. in June, 1939, and was appointed Faculty Instructor of Physics at Harvard. After the U.S. entered the Second World War, Aiken enlisted in the U.S. Naval Reserve. He was aware of the tremendous help his calculator could be to the war effort, yet the construction had some time to go and Aiken had to wait.

Some time during this anxious period, Aiken met Agnes Montgomery, a young Latin teacher pursuing a Master's Degree in Education at Harvard—a rare phenomenon at that time. "Monty," as she preferred to be called, was quite an extraordinary young woman. The daughter of Scottish immigrants who had become well-to-do, she graduated from Wheaton College and spoke several languages, including French and

Russian. She was introduced to Aiken by mutual friends at Harvard. She and Aiken would hop in her Ford Coupe and take picnics into the pastoral countryside surrounding Boston. They would spend hours talking and laughing. Both had an abundant sense of humor. Monty's laugh was high and gay and her flaxen hair and blue eyes shone in the New England sun.

Aiken divorced Louise in 1942.²³ Soon he and Monty were married in a small ceremony at her parents' house in Worcester, Massachusetts. By then Aiken was on active duty in the Naval Reserve as a Commander and on a leave of absence from the University. He cut a dashing figure in dress whites, standing ram-rod straight at over six feet tall. The Navy assigned Aiken to teach mathematics at the Naval Mine Warfare School in Yorktown, Virginia. Although he made many friends at the Mine School, he did not relish the assignment.²⁴

Wartime Advances

The work on the calculator had progressed far enough that the first problem was run on it in January 1943, but it was not until December of that year that the calculator was demonstrated at Endicott to President Conant.²⁵ The urgency of the war effort caused things to move quickly. In February, 1944, the ASCC was disassembled at Endicott and shipped to Harvard. Aiken was transferred from the Mine School to Har-

Posing in front of the ASCC at its dedication, August 14, 1944, are (left to right): Frank E. Hamilton (IBM), James Bryant Conant (President of Harvard University), Thomas J. Watson, Sr. (President of IBM), Claire D. Lake (IBM), Howard Hathaway Aiken (Harvard), and Benjamin M. Durfee (IBM). (Photo courtesy of Harvard University)



vard to run the calculator for the Navy. Lake and several other IBM engineers reassembled the machine in the basement of the Research Laboratory of Physics. Meanwhile, Aiken assembled a contingent of Naval personnel to operate the Mark I. Among these were Lieutenant Grace M. Hopper, later instrumental in the development of the computing language COBOL, and Ensign Robert V.D. Campbell, who had been the national chess champion in his age-group as a youngster.²⁶ By May 1944, the calculator was complete and beginning to turn out results for the Navy's Bureau of Ships. Its first project was the computation of tables of values for Bessel functions—a family of mathematical problems encountered in designing ships.

Friction

Amid great hoopla, IBM formally presented Harvard with the ASCC on August 14, 1944. Whether through a misunderstanding or a conflict in their strong personalities, Watson and Aiken had a falling out over this event which was never repaired. One story has it that Aiken leaked word of the dedication to the press before IBM's media blitz. Consequently, it was Harvard that got most of the publicity, after IBM had spent half

a million dollars building the machine. President Conant visited Watson in his hotel room in Boston to cajole him into attending the ceremony. Although Watson put on a happy face for the press, emotions were still very strained. As Thomas J. Watson Jr. later recalled, it was a tense scene in which "[i]f Aiken and my father had had revolvers they would both have been dead."²⁷ Time did not soothe this wound. Twenty-five years later, at an exhibition on computing history, T.V. Learson, then chairman of IBM, had only one comment to make about the two-thousand years of history spread before him. He paused briefly in front of a photo of Howard Aiken and muttered "the sonofabitch."²⁸

Despite the conflict, both Conant and Watson hailed it as the beginning of a new era of cooperation between the two institutions and between science and industry in general. The press marveled at what it called a "giant electric brain." Speculation ran rampant as to how machines such as this might affect the world. Science had overcome its biggest hurdle, they claimed—it had created a thinking machine. *

The Shape of the Future

The media fueled the public's imagination. Aiken received letters from

people interested in the Mark I and how the new machine would affect them. Many of these letters were from fellow mathematicians and physicists with problems they wished solved, or inquiring where they might acquire such a machine. Many hoped this machine could answer problems long unsolved. They had yet to deal with the economics of information processing. Aiken politely replied that at that time the Mark I was engaged full-time with work for the war effort and could not be spared to solve their interesting problems. Furthermore, there were no machines like the Mark I commercially available. School children wrote asking how they might grow up to build such marvelous machines. One even asked if his laborious calculation of the value of Pi to 28 decimal places was correct. Aiken's replies to these youngsters was one of restrained encouragement. Study mathematics, physics, and electrical engineering first, before designing any machines, he said.

Mathematicians, professional and would-be, were not the only ones to recognize the potential that the Mark I represented. Since the Mark I was automatically controlled, many people anticipated that other kinds of machinery might operate without human intervention. Some saw this possibility as a

son, others as a threat. A printer wrote to Aiken asking about the ramifications of the Mark I for the possibilities of an automatic typesetting system to increase the productivity of his business. On the other hand, a labor union leader expressed concern about the implications for American factory workers of automatically controlled machines. He wished to talk to Aiken about the extent to which "labor-displacing techniques" might be employed at the cost of workers when the War was over.²⁹ Aiken replied that his time was utterly devoted to the Navy, but the union official might be interested in speaking with Professor Shapley at Harvard or Professor Norbert Wiener at MIT.³⁰ With astonishing precision, lay people saw many of the long-run implications of the movement of which the Mark I was the vanguard.

Many professionals interested in computing machines wrote to Aiken to complain that the media reports were too sensational and no professional paper had been published describing the machine. Aiken assured these writers that he would publish a thorough report of the computer at the earliest opportunity. In 1946 the Harvard University Press published Volume 1 of the *Annals of the Computation Laboratory of Harvard University, A Manual of Operation for the Automatic Sequence Controlled Calculator*, compiled from the notes of the staff and designers by Aiken and Lt. Hopper.

The manual gave an elaborate description, illustrated with diagrams and photographs, of the physical construction, the electrical circuitry, and the operation and programming of the Mark I. In the foreword, President Conant gave a brief description of the development of the ASCC, and stated: "I cannot refrain from paying tribute to Mr. Watson . . . the scientific world is indebted to him."³¹ Conant also stressed the synergistic relationship between science and industry that the ASCC represented. Following Conant's statement is Aiken's preface. Aiken named Lake, Hamilton, and Duffee as co-inventors of the ASCC, and expressed gratitude to the Navy on behalf of the staff for the "privilege of working with the calculator."³² It had been a mathematician's dream-come-true.

Staggering Dimensions

A Manual . . . provides a detailed description of the physical composition of the Mark I. Over fifty feet long, the

Mark I was finished in glass and metallic gray panels in the round, streamlined style characteristic of industrial design in the late 1940's. The machine's physical dimensions were staggering: at eight feet tall, three feet deep, with two, six-foot-long sections projecting off the rear, it weighed 5 tons.³³ This massive frame held 765,299 separate parts, including over 3,000 relays (electric switches), and 225 circuit breakers, connected by 530 miles of wire!³⁴ A four-horse-power electric motor drove a shaft extending the length of the machine, which powered all of the mechanical components by gears or chains. The machine performed calculations through a combination of electrical and mechanical processes. Over 1,200 ball bearings kept the components smoothly churning out numbers.³⁵

Looking at the machine from the front, one saw on its left end a bank of 1,444 black dials behind sliding glass panels. These were the "constant registers." (A register is a place in which a number is stored in a computer.) There were 60 of these constant registers, each consisting of 24 ten-position dials. Each register held one 23-digit number—one dial per digit—the final dial indicating the number's sign (positive or negative). These switches would be manually set at the beginning of each program according to the equation being solved. Since the value of these registers remained unchanged during the operation of the program they were given the name "constant registers." The sections where numbers produced and changed during calculations were kept were called "storage registers," or "storage counters." There were a total of 72 storage counters, again, each capable of containing a 23-digit number and its sign. The storage counters were made of electro-mechanical "wheels"—24 per counter. Each wheel was mechanically driven by a drive-train system connecting it with the main drive shaft and motor. Depending upon its position, metal brushes mounted on the wheel would complete one of ten possible circuits. Each circuit represented a different decimal digit. To add a number to the number stored in a counter, the wheel was mechanically advanced that number of positions. For example, to add four to the stored number, the wheel advanced four positions. This caused the brushes to complete the circuits representing the sum of the two numbers. The

computer automatically carried any overflow to the next digit counter.

While the counter wheels were usually reliable, occasionally deposits would build up on the brush surfaces causing them to complete circuits sporadically. When this happened the procedure was to shut off all the lights in the computer room while the computer was running. Any counter that sparked as electricity arced over the space caused by sediment build-up was replaced, cleaned, and kept as a spare.³⁶

One time a problem was caused by a peculiar kind of deposit. On a hot summer day the calculator ceased to function properly. Despite every effort, no explanation could be found for the problem. The only option left was to begin taking apart the machine. The technicians rolled up their sleeves and set to work, carefully pulling out each component and inspecting it thoroughly. In spite of the open windows—in the absence of air conditioning—it was sweltering in the basement of the Physics Labs. Finally, after hours of sweaty work, the technicians found the culprit. A small moth was caught in the contacts of one of the relays, preventing current from flowing through the component. The deceased moth was taped into the logbook above the entry that "a bug had been found in the computer." Soon "bug" became the term for any inexplicable problem and has remained so in computer lingo ever since.³⁷

Special Features

Certain of the 72 storage counters had special features. For example, storage counter #70 converted any number placed into it to its absolute value; i.e., it converted its sign to positive. Storage counter #71 was called the "multiple in-out-counter." In effect, it doubled the calculator's storage capacity while halving its accuracy. This was accomplished by treating the contents of counter #71 as two separate 12-digit numbers, rather than a single 23-digit number. Counters 68 and 69, and 64 and 65 accomplished the reverse. They essentially halved the calculator's capacity, but doubled its accuracy. The numbers stored in 68 and 69 were treated as one long 46-digit number; likewise for counters 64 and 65. Two pairs were needed for the purpose of adding two 46-digit numbers together.³⁸

While addition and subtraction were performed directly in the storage

Lt. Grace Hopper and the Mark I

Lt. Grace Hopper was assigned by the Navy to work on the Mark I at Harvard in 1944. Two programming ensigns, Robert V. D. Campbell and Richard M. Bloch, were on board when she arrived. Four enlisted men were also assigned to operate the machine, Hugh Livingston, John Mahoney, Donald Calvin, and Derwood White.

She recalls, "They were called specialists 'I'. Their insignia was a diamond with an 'I' in it. The 'I', of course, stood for IBM. Later Yeoman Frank O'Donnell brought order out of chaos and Lt. Arnold and Ensigns Lockhardt and Brennan joined the crew. Civilian members came, but it was a small crew and a very big machine.

"I only know one person who was able to write a program in ink and have it run the first time. That was Dick Bloch. He drove nearly all of us crazy because he could do that. Since the Mark I was a relay and step counter machine, it was not too difficult to change the circuits. Every once in a while, Dick would get the idea of a new circuit that would make his problem run faster. He'd get together with one of the operators during the night and they would "fix" the circuit. The next morning my programs wouldn't run. It's much better to have machines that the programmers cannot alter.

"Commander Aiken was a tough taskmaster. I was sitting at my desk one day, and he said, "You're going to write a book." I said, "I can't write a book." He said, "You're in the Navy now." And so I wrote a book. I have it here with me. This is the Mark I manual.

"Howard Aiken always said that one day we would have computers that would fit in a shoe box. I don't know how he knew that, but he did."



Commodore Grace Murray Hopper, speaking at The Computer Museum, April 14, 1983.

counters, multiplication and division were executed in a central unit to the left of the storage counters. The multiply/divide unit was a sophisticated assembly of electrical and mechanical components.³⁹ When two numbers to be multiplied were received by the unit, it would immediately set up a "table" of the multiples of the multiplicand (the top number in long-hand multiplication) and the nine non-zero decimal digits. Then it would examine the multiplier (the "bottom" number) starting with the units digit. The unit would add together the multiples of the multiplicand corresponding to the values of the digit places of the multiplier. This produced the final product. Division was performed by a method similar to the one above executed in reverse. Often programs would use a function for evaluating reciprocals (based on an algorithm developed by Aiken in 1938) to avoid division.⁴⁰ This was done to save time, since at full capacity the calculator could multiply two numbers in 5.7 seconds, while it took 15.3 seconds to perform a division.⁴¹

Next to the multiply/divide unit were mounted three "interpolators." These units were used to obtain values for certain mathematical functions, such as cosine or hyperbolic sine. The values of a function were encoded on paper tapes prepared for certain values of the variable. (In the case of cosine, this might be the cosine for every half degree between 0 and 90.) Also encoded on the tape were coefficients which allowed the machine to determine the value of the function to the accuracy needed in the problem.⁴² The interpolators, large mechanical punched paper tape readers, allowed the calculator to find the value of a function for any variable. This allowed a programmer to use a function in his program simply by loading the appropriate function tape into an interpolator unit, rather than having to write out the algorithm for its calculation, saving a great deal of time for both the programmer and the machine.

The most important component of the ASCC, the automatic sequence unit, was mounted at the right edge of the body of the machine. This unit read the program from punched paper tapes to control the flow of numbers and the performance of operations within the calculator. The paper tape had a three-section line of 24 holes across its width. The pattern of holes in the first two

sections indicated the locations of the numbers to be acted upon. This determined the flow of data along the "bus" or large circuit, which connected all sections of the computer. The third section specified what operation was to be performed upon the numbers.⁴³ The sequencer automatically advanced the tape in synchrony with the internal operations of the calculator. Every line of the program had to include a seven in a specific location to tell the computer to advance to the next line—if there was no seven, the calculator stopped and a bell rang.⁴⁴ The Mark I also automatically checked its calculations for errors, if one occurred, it would stop and the bell would ring to notify the operator.

The final three calculating sections of the ASCC were electro-mechanical tables for the calculation of logarithms to base ten, powers of ten, and sines.⁴⁵ In addition to the sequencing unit and constant switches, information could be entered into the calculator via two punched card readers. Results of calculations could be punched onto standard IBM punched cards or typed on automatic typewriters.⁴⁶

In addition to describing the mechanical and overall operation of the Mark I, *A Manual . . .* outlined the electrical function and circuitry of the calculator in Chapter Three. The final three chapters dealt with the programming and operation of the calculator. To compliment *A Manual . . .* on this score and further assist the programmer, Aiken and Ensign Robert Campbell (the only person ever to have run a program correctly on the first attempt) compiled a complete code book.⁴⁷ The code book elaborated the basic means of programming almost every type of mathematical problem known.⁴⁸

In sum, the Mark I was a vast electro-mechanical calculator which automatically performed decimal arithmetic under programmed control. As the first computer to hit the public with a splash, the Mark I paved the way of the Computer Age.

A New Business for IBM

The public impact is one of the most important influences of the Mark I, but the effect it had upon IBM is also worth noting. The ASCC, IBM's first successful venture in the realm of automatic general-purpose calculators, was built by a team who became influential in the design of many of IBM's later products.

Lake and Durfee went on from the Mark I project to construct the Pluggable Sequence Relay Calculator. Less sophisticated than the Mark I, the various parts of this computer were literally connected by wired plug boards to sequence calculations. However, the use of plug boards and electro-magnetic relays allowed it to run faster than its predecessor.⁴⁹ Two of the machines were installed at the Watson Scientific Laboratory at Columbia University. Wallace Eckert, the director of Columbia's Watson Lab, and Frank Hamilton from the ASCC project, then designed the Selective Sequence Electronic Calculator (SSEC). The SSEC was a hybrid machine, composed of both electro-mechanical relays (advocated by Hamilton for their reliability) and electronic vacuum tubes (suggested by Eckert for their speed).⁵⁰ Although it was dismantled in 1952, only four years after its widely-publicized dedication, the SSEC was important because members of its design team went on to play crucial roles in the design of some of IBM's first fully-fledged computer systems.⁵¹

The history of the Mark I's use at Harvard is also very important. Many revolutionary applications were developed for the calculator which broadened the scope of computing at an early stage. During the War, the calculator was used to generate mathematical tables of the values of certain complex functions, such as Bessel functions and Henkel functions. These functions were important in such applied physics problems as ship design, ballistics, and radio wave propagation. Until the Mark I, only a few values of the Bessel function had been calculated since its definition two-hundred years before.⁵¹ The values of these functions were published in volume after volume of the *Annals of the Computation Laboratory*. . . . To insure the accuracy of these tables, they were photographically printed directly from the typed output of the calculator. The Mark I was also rumored to have performed calculations for the Manhattan Project.⁵²

Original Applications

After the War, at Aiken's insistence, the Mark I was used on several very original projects. Among these were programs for translating languages, and analyzing econometric models. This latter work, developed by Harvard Professor of Economics Wassily Leontief, simulated the effects of economic currents

upon national economies, and eventually led to a Nobel Prize in Economics. Leontief's was the first application of a computer to a problem in the social sciences. Aiken also urged a friend to perform his research on Newton's *Principia* on the computer.⁵³ In 1947 and 1949, the Harvard Computation Laboratories sponsored two symposia on "Large-scale Digital Calculating Machines." High on the agenda of both these conferences were discussions of new applications of computers, particularly in unconventional fields such as physiology.

The emphasis placed upon finding new applications for computers was an extension of the motive which drove Aiken to pursue the construction of an automatic calculator in the first place. "You see," Aiken said, "I used to have a lot of figuring to do and I thought it would be nice to have a machine that would make my job easier."⁵⁴ Aiken's true concerns were the results which computers could help achieve. He ventured to produce a computer only because one could not be acquired elsewhere. Later, when a commercial computer industry had developed, Aiken ceased constructing computers in favor of concentrating on research in their application and basic design. He built a curriculum at Harvard in Applied Mathematics with specific concentration on computing machinery, and advocated international cooperation in the field of computing.

The Birth of the Lab

At the end of World War II, Aiken completed his Naval service and rejoined the Harvard faculty as a Professor of Applied Mathematics. He was appointed director of the Harvard Computation Laboratory when it became independent of the Navy at the end of the Bureau of Ships contract. Aiken worked assiduously to build the staff and facilities of the Computation Lab and encourage its use throughout the University. In addition to teaching, working on the design of Mark I's successors, consulting, and traveling across the globe, Aiken arranged the financing and construction of a building to house the Computation Laboratory. The building was dedicated in 1947 at 33 Oxford Street, just north of Harvard's physics buildings. Financed primarily by government funds (many of them from the rental of the Mark I), the two-story brick building contained office space, lecture halls, a

machine shop, and a sixty-foot-square room for the installation of computers. The computer room had a large observation window for visitors. The Mark I was moved from its basement location to the modern brick building in late 1946. Upon its dedication, Harvard officials referred to the Lab as the first building of a "Science City" which would house facilities for all of the varied fields of natural science in one massive complex.⁵⁵ The first building of a centralized science complex seemed an appropriate place for a facility which, as Aiken saw it, would serve all disciplines.

With the construction of proper facilities completed, Aiken saw the immediate mission of the Computation Lab as two-fold: to build a large modern computer for use exclusively by the University, and to develop techniques and a curriculum of mathematical analysis so that the use of computers might spread throughout all fields.⁵⁶

At the end of World War II, the Bureau of Ships contract for the operation of the Mark I expired. To finance the operation of the calculator, Harvard entered into a contract with the Navy's Bureau of Ordnance. The Bureau of Ordnance paid the operating costs of the Computation Laboratory in exchange for having ballistics calculations performed on the Mark I. Unfortunately, the Bureau's projects took up most of the calculator's time, leaving little for academic research. In 1945 the Bureau of Ordnance had contracted Harvard to construct a large relay computer to be installed at the Naval Proving Grounds in Dahlgren, Virginia.⁵⁷ This contract included the operation of the Mark I until the second calculator was completed. The Mark II, finished in March 1947, was shipped in 20 trailer trucks to the Naval Proving Grounds. The largest computer in existence, it contained over 13,000 relays and was employed in the solution of complex ballistics problems.⁵⁸ The completion of Mark II signalled the end of the Bureau of Ordnance's support of the Mark I. To keep the Mark I operating, the Laboratory entered into several contracts with the Air Force and the Atomic Energy Commission. Under these contracts academic computing suffered as it had under the Bureau of Ordnance's support.

Even before the Mark II was completed, the Bureau of Ordnance extended its contract to include the construction of a further computer, the Mark



III, for installation at the Navy's Aberdeen Proving Grounds. The Mark III used vacuum tubes to perform calculations; as a result it was 250 times faster than the Mark I, and 25 times faster than the Mark II. The Mark III also incorporated a magnetic drum memory with a capacity of 64,000 digits.⁵⁹

By this time Aiken emphasized that Mark I would not be able to satisfy the computation needs of the University. Therefore, he advocated the construction of a larger calculator to serve the needs of academic research at Harvard. To complete the computer as expeditiously as possible, Aiken recommended that the Mark IV, as it was to be called, be very similar to the Mark III. Once again, however, Aiken ran into financing problems. In order to build the computer, he had to rent time on it to government agencies and private industries. When the Mark IV was complete in 1952, it was installed opposite its great-great-grandfather, the Mark I, in the Computation Laboratory.

While the effort to provide the University with a sizable computer came

to only partial fruition, the second goal of establishing a curriculum in computing was achieved with the military's help. In 1947 the Office of Naval Research sponsored a one-year Master's of Science program in the field of computing machinery. The following year, the Air Force took over responsibility for the program. By 1949 76 students had enrolled in the program, and 14 M.S. and 1 Ph.D. had been granted.⁶⁰ Aiken was instrumental in sponsoring and developing the curriculum for this program. In 1955, Harvard announced the introduction of a complete Master's and Doctoral program in Applied Mathematics focussing on the problem of automatic control. It was one of the first universities to offer such a program.⁶¹

The Boss

With its two primary objectives somewhat satisfied and private industry ready to take on the construction of computers, the Computation Laboratory became a major center for research in computer design and theories of mathematical computation. One of the only

institutions of its kind, it attracted many promising students and teachers. Visitors came from all over the globe. The Lab was a diversified and stimulating community, over which Aiken held unchallenged sway. "The Boss," or "the Old Man," as his students referred to him among themselves (he was always Professor Aiken in person) was remembered as an inspiring teacher, who had a way of driving people to achieve things they thought they could not possible do. Although he was not the chummy sort, (he always maintained the formal relationship of teacher versus student) Aiken was very accessible despite his frantic schedule.⁶²

The Lab was characterized by pride and perfectionism. With two computers operating round-the-clock, courses to be planned, and many pioneer research projects underway, lights blazed all night in the computer room and the offices downstairs. "The Boss" was likely to show up at any hour, including four in the morning, to ask if the computer was "making numbers" (i.e. running smoothly), or to try some new idea.

kitchen was set up off the side of the computer room for those working the late shifts. When an error occurred during the running of a program, the Mark I would stop and a bell would sound. Often the operator would find that Aiken had beaten him to the side of the machine. Aiken would stand rocking forward and backward on the soles of his patent leather shoes, hands fidgeting in his front pockets. "Well, what are you going to do about it?," he would prod. If the calculator had not soon resumed operating, Aiken would take off his jacket and set to work with the operator to solve the problem. This near obsessive drive to keep everything running like clockwork made Aiken the butt of good-natured kidding and practical jokes.

One day Aiken arrived at the Lab and, as always, went directly to the chart which indicated the status of the calculator. Instead of a blue line, indicating error-free operation, there was a solid red line, showing the computer had not been operating all night long. "What the hell is going on here?," he burst out at the operator on duty. "Where's Hawkins [the Chief Operator]?"

"Downstairs." Off Aiken stormed on seven-foot strides. When he found the Chief Operator, he growled, "What the hell are you doing here reading the paper? Why aren't you upstairs? The goddamn machine's been broken for thirteen hours."

"You're crazy. The machine ran all night long," responded the Chief Operator.

"Well the goddamn chart is red," Aiken thundered as he strode back upstairs. He returned to find the operator removing a strip of red tape which had been covering the blue line on the chart. "Well, I guess I've been had," he grinned. When the operators recovered from their laughter, they presented Aiken with a large red badge which he sported the rest of the day.⁶³

Aiken had a combination of a dry, teasing wit, and the ability to laugh at himself. His secretary recalled that on her first day she spilled a pile of books in the middle of the hall. "It's about time I picked those up," Aiken said flatly with a small smile as he ushered some visiting Navy brass around the prostrate woman.⁶⁴

Aiken's firmness, drive, and humor made him a good leader for an eager and brilliant staff. Most who worked

with him speak of Aiken in the fondest and most admiring of terms. Yet a comment that Aiken made to a student once betrays the attitude which earned him the enmity of some, and caused him to become disillusioned in later years: "Don't worry about people stealing your idea," he said. "If it's original you will have to ram it down their throats."⁶⁵ This attitude represented what his critics claimed was Aiken's condescending and superior air.

After the War, Aiken traveled widely assessing computing progress across the globe. Convinced of the value of the results of calculations to all people, Aiken pushed for the establishment of an International Computing Laboratory under the auspices of the United Nations. These aspirations proved politically unfeasible, and Aiken later wrote to a friend that the complications of an international bureaucracy proved insurmountable.⁶⁶

Aiken attacked bureaucratic red tape with the vigor that characterized all his work. For example, his lobby efforts to allow Harvard to operate radio transmitters without a government-licensed operator eventually led to legislation making communication satellites possible.⁶⁷ The reluctance of Harvard to fund the development of proper computing facilities greatly hindered Aiken's efforts. University policy also forbade him to do any classified government work. This made supporting the computers all the more difficult. It is understandable that Harvard had trouble justifying the great expense of a facility which fell under the domain of no department, and was difficult to think of as a utility like electricity or heat. As a result, the administration's attitude seemed to be "you want it, you fund it."⁶⁸ This Aiken did, by charging for computer time, private contracts, and soliciting donations. He arranged the contribution of a UNIVAC 1 computer system during the mid-1950's. A tumultuous conflict surrounding the purchase of an IBM 7090 computer system proved to be the final straw. Aiken retired from Harvard at the minimum age in 1961, to avoid falling "into the trap which has caught so many of my senior colleagues."⁶⁹

Life After Harvard

The desire to start a new life and learn new things at age 61 applied to his private affairs as well as his career. He divorced Monty and soon married Mary

MacFarland of Coral Gables, Florida.

His activities increased upon retirement. In 1963 he formed his own company, Howard Aiken Industries, Inc.⁷⁰ He also accepted positions on the board of directors and consulting staff of several firms. In addition, he held a distinguished service professorship at the University of Miami. While there he designed and established a computing center with the aid of the local Chamber of Commerce.

Aiken soon moved to Florida, where he lived with his new wife and his two step-daughters. During their rare moments of relaxation together, they enjoyed walking along the beach, swimming, and listening to music. On the whole, however, Aiken had little time for recreation, relaxing while en route to airports.⁷¹ While on business in Missouri, Howard Hathaway Aiken died on March 14, 1973—six days after his seventy-third birthday.

At a memorial service in his honor in Memorial Church at Harvard, friends and colleagues gathered to remember the life and accomplishments of Howard Aiken. The range of tributes attest to the diversity of his life. Students remembered him as a great teacher, others remembered him as a great Naval officer, and scientist—all remembered him as a proud and kind man. A former employee later wrote, he was "the only completely moral man I ever knew."⁷²

Aiken's work and achievements earned him wide recognition in Europe and the United States. He received many honorary degrees and awards from all over the world. In acknowledgement of his contributions, Harvard University named the computer laboratory the Howard Hathaway Aiken Computation Laboratory in 1964.

His wife, Mary, described Aiken's life best when she wrote: "It was certainly a colorful, inventive, stormy, and changing life. He came into the world and left it in a fast clean-cut way."⁷³

Endnotes

Special thanks to Professors Thomas Cheatum and Anthony Oettinger of Harvard University.

Abbreviations

HUA—Harvard University Archives, Harvard University, Cambridge, Massachusetts.
AOF—Active files of Dr. Anthony Oettinger, Chairman, Program on Information Resources Policy, Harvard University, Aiken Computation Laboratories, 33 Oxford Street, Cambridge, Massachusetts.

¹H.H.Aiken, "Memorandum on the Computation Laboratory," (Cambridge, MA, October 19, 1949), Computation Laboratory Collection, HUA, p. 1.

²Howard Hathaway Aiken A Giant Among Us in Computer Design, *Harvard University Gazette*, vol. LXIX: no. 37, p. 8.

³Howard H. Aiken to Dr. Warren Weaver, September 5, 1940, Computation Laboratory Collection, "Correspondence of Howard H. Aiken, Director, 1944-1961," Box: A-C, Folder: "Correspondence Before '44," HUA.

⁴*ibid.* The dates indicated in this letter differ from those of Aiken's Curriculum Vita. I have chosen to regard the letter as the accurate source. The letter was composed by Aiken himself, while the c.v. might have been drawn up by a secretary. Furthermore, the letter was composed nearer the dates in question. (The copy of the c.v. I have seen was compiled in 1961.) The c.v. indicates the dates of Aiken's early employment as follows:

Madison Gas and Electric Company,
1919 to 1928,

Western Electric and Manufacturing
Company, 1928 to 1931,

Line Material Company, 1931 to 1932.

⁵Howard H. Aiken to Rowland Stokes, August, 30, 1944, Computation Laboratory Collection, "Correspondence of Howard H. Aiken, Director, 1944-1961," Box: A-C, Folder: "Bureau of Ordnance," HUA.

⁶Howard Hathaway Aiken A Giant Among Us . . . , p. 8.

⁷IBM Automatic Sequence Controlled Calculator, International Business Machines, 1945, Aiken Files, Folder: "Marks," AOF, p. 2.

⁸Anthony Hyman, *Charles Babbage, Pioneer of the Computer*, (Princeton, N.J.: Princeton University Press, 1982), p. 130.

⁹Brian Randell, *The Origins of Digital Computers*, (New York: Springer-Verlag, 1982), p. 204.

¹⁰"Proposed Automatic Calculating Machine," Computation Laboratory Collection, "Personal Files of Howard Aiken," HUA, p. 5.

¹¹*ibid.*, pp. 7-18.

¹²*ibid.*, p. 18.

¹³*ibid.*, pp. 19-21.

¹⁴*ibid.*, p. 21.

¹⁵*ibid.*, p. 18.

¹⁶Howard Hathaway Aiken A Giant Among Us . . . , p. 8.

¹⁷*ibid.*

¹⁸IBM Automatic Sequence Controlled Calculator, p. 2.

¹⁹Harry Mimno, "Notes by Harry Mimno," Aiken Files, AOF, p. 6.

²⁰IBM Automatic Sequence Controlled Calculator, pp. 2-3.

²¹*ibid.*, p. 3.

²²*A Manual of Operation for the Automatic Sequence Controlled Calculator*, Annals of the Computation Laboratory of Harvard University, vol 1, (Cambridge, MA: Harvard University Press, 1946), Introduction.

²³"Co-inventor of Harvard 'Brain' Needs it for His Own Dilemma," Howard H. Aiken Biography File, HUA.

²⁴Howard H. Aiken to E.S. Gilletti, November, 28, 1944, Computation Laboratory Collection, "Correspondence of Howard H. Aiken, Director, 1944-1961," Box: A-C, Folder: "Bureau of Ordnance," HUA.

²⁵IBM Automatic Sequence Controlled Calculator, p. 3.

²⁶Interview with Robert Burns, Manager, Harvard University Parking Office, 29 Garden Street, Cambridge, Massachusetts, November 28, 1984. Burns, an operator of the Mark I, recalled this fact in a conversation on November 28, 1984.

²⁷Katherine Davis Fishman, *The Computer Establishment*, (New York: Harper and Row, Publishers, 1981), p. 36.

²⁸*ibid.*, p. 37.

²⁹Ted E. Silvey to Howard H. Aiken, November, 25, 1944, Computation Laboratory Collection, "Correspondence of Howard H. Aiken, Director, 1944-1961," Box: A-C, File: "Bureau of Ordnance," HUA.

³⁰Howard H. Aiken to Ted E. Silvey, December, 5, 1944, Computation Laboratory Collection, "Correspondence of Howard H. Aiken, Director, 1944-1961," Box A-C, File: "Bureau of Ordnance," HUA. Norbert Weiner was one of the first to envision many of the consequences of the broad use of computer-controlled machinery, a phenomenon he called, "cybernation."

³¹*A Manual of Operation . . .*, Foreword.

³²*ibid.*, Preface.

³³*A Manual of Operation . . .*, p. 11.

³⁴IBM Automatic Sequence Controlled Calculator, p. 6.

³⁵*A Manual of Operation . . .*, p. 58.

³⁶Interview with Robert Burns, November, 28, 1984.

³⁷Grace Hopper, "Howard Aiken and the Harvard Mark I," Lecture Collection of The Computer Museum, Boston, Ma.

³⁸*A Manual of Operation . . .*, p. 17.

³⁹IBM Automatic Sequence Controlled Calculator, p. 5.

⁴⁰*A Manual of Operation . . .*, p. 27.

⁴¹IBM Automatic Sequence Controlled Calculator, p. 6.

⁴²*ibid.*, p. 5.

⁴³*A Manual of Operation . . .*, p. 11.

⁴⁴*ibid.*, p. 15.

⁴⁵*ibid.*, p. 11.

⁴⁶*ibid.*

⁴⁷Interview with Robert Burns, November 28, 1984.

⁴⁸IBM Automatic Sequence Controlled Calculator, p. 6.

⁴⁹Randell, p. 192.

⁵⁰*ibid.*, p. 193.

⁵¹"New Faster Mechanical Brain Being Built At Harvard for Navy," Computation Laboratory Collection, "Clippings, Etc.," HUA.

⁵²Interview with Robert Burns, November, 28, 1984.

⁵³LB.Cohen to Kenneth Iverson, April, 23, 1981, Aiken Files, AOF.

⁵⁴"Says Era of Mechanical Calculators Lies Ahead of Us," *Boston Sunday Post*, December 28, 1947, p. 4.

⁵⁵"Harvard Puts Big Calculator in New Home," *The Christian Science Monitor*, December, 30, 1946.

⁵⁶H.H.Aiken, "Memorandum on the Computation Laboratory," p. 8.

⁵⁷Randell, p. 192.

⁵⁸"New Faster Mechanical Brain Being Built at Harvard for Navy."

⁵⁹"The Thinking Machine," *Time*, vol. LV: no. 4, January 23, 1950, p. 54.

⁶⁰Aiken, "Memorandum on the Computation Laboratory," pp. 1-3.

⁶¹R.L.Ashenurst, "Remark Prepared for Memorial Service," May 7, 1973, Aiken Files, Folder: "Harry Mimno," AOF, p. 2.

⁶²Kenneth E. Iverson, "Howard Aiken, Friend and Mentor," April, 1973, Aiken Files, Folder: "Harry Mimno," AOF.

⁶³Interview with Robert Burns, November 28, 1984.

⁶⁴Jacquelin Sanborn Sill, "A Non-Academic Tribute to Howard Aiken," Manchester, Massachusetts, March 1973, Aiken Files, Folder: "Harry Mimno," AOF, p. 2.

⁶⁵Iverson.

⁶⁶Howard H. Aiken to Dr. John Womersky, September, 23, 1952, Computation Laboratory Collection, "Correspondence of Howard H. Aiken, Director, 1944-1961," Box: C-I, Folder: "England Dead File," HUA.

⁶⁷Harry Mimno, pp. 2-4.

⁶⁸Interview with Harvey Brooks, Benjamin Peirce Professor of Technology and Public Policy, Harvard University, Division of Applied Sciences, Aiken Computation Laboratory, 33 Oxford Street, Cambridge, Massachusetts.

⁶⁹Howard H. Aiken to Dr. John C. Baker, October 31, 1961, Computation Laboratory Collection, "Correspondence of Howard H. Aiken, Director, 1944-1961," Box: A-C, Folder: "Bureau of Ordnance," HUA.

⁷⁰"Biography of Howard Hathaway Aiken," Aiken Files, AOF, p. 3.

⁷¹*ibid.*, p. 4.

⁷²Martin E. Flaherty to David A. Harnett, October 14, 1974, Aiken Files, Folder: "Harry Mimno File," AOF.

⁷³Mary E. Aiken to David A. Harnett, November 19, 1974, Aiken Files, AOF.



Howard Aiken looks over some newspaper clippings in the lounge of the Computation Laboratory. (Photo courtesy of Harvard University)

A Conversation with The Hackers

The following is transcribed from the December 16, 1984 program at The Computer Museum, "A Conversation with Steven Levy and the Hackers." The Museum invited the cast of characters from the book, HACKERS: Heroes of the Computer Revolution (Doubleday Press, November, 1984), and its author, Steven Levy, to stage a reunion of the original MIT hackers from the 1950's and 1960's. These are the visionaries whose obsessive games-playing, inventive programming, and anti-authoritarian ethic fueled the computer revolution.

The Cast of Characters

Steven Levy

and

Alan Kotok—like a God, he understands hardware; a legendary hacker.

Steve "Slug" Russell—best known for developing SpaceWar; never made a dime from it.

Tom Knight—arrived at MIT at age 16; a member of the second generation at the A.I. lab.

Mike Beeler—involved with the program called LIFE.

John McKenzie—watched over the hackers on the TX-0 and the PDP-1, and looked out for the hardware—especially the hardware.

Don Eastlake—member of the midnight computer wiring society.

Marvin Minsky—professor of the A.I. lab.

Gordon Bell—a hardware hacker.

Tom Eggers—a hacker "drop out" from MIT.

Richard Stallman—the last of the hackers.

Steve Levy: After the publication of the book, I did a lot of radio interviews and usually the first question anyone asks is, "How could you call those people heroes? These are kids who break into things all the time?" In reply, I had to patiently explain that at one time hacker meant something else. It was a badge of honor among people implying either wizardry or elegance in using the computer. The early MIT hackers did some things with computers that eventually enriched our lives.

How do you feel about the current view of hackers, especially the malicious view?

Alan Kotok: The use of the term faded in the seventies and re-emerged in a new context and was a new word. There was no common line or heritage between the two, but maybe there is a line between the two.

Tom Knight: I still think of myself as striving for the same kind of excitement that a hacker has, but I have less and less time.

Steve Levy: Are hackers born or made? Some people at the hackers conference in California suggested that hackers are born, like baby ducks—when they see something moving, they will follow it, like a hacker has to do.

Mike: As a kid I used to play with plugs and wires, thus scaring my parents. Everyone that has some experience hacking has played with hardware when they were small.

Tom Knight: You need to have a predisposition to either constructing things or logic. Now, of course, there are hackers that are purely software so might not have had to have the same childhood experience. When I was growing up, there just weren't computers, so I hacked organic chemistry for a while. Electronics was one of the only outlets. There wasn't anything else.

Alan: Model railroads.

Steve Russell: And relays. A very elaborate model railroad—that is a parallel.

Steve Levy: Since the anti-social hacker is a myth, how much did the community that evolved around hacking keep you going?

Steve Russell: Hackers were very exclusive and some people may say that their behavior is "anti-social" or not very social. There were few hackers who were reluctant to talk when the right person came along or the right subject came up.

Alan: It wasn't an isolationist type hacking in the old days. No one was in their bedroom, independent of the rest of the world. There was an "in crowd" and some rites of passage into the crowd. The atmosphere was intense among the people involved. You needed someone to talk to about ideas. There were always large crowds going out to dinner together.

Tom Knight: The lack of computers during that era and the fact that there was no timesharing led to more interaction between the hackers in the early sixties than between similar people today. Today you can go to RadioShack or ComputerLand and buy computers that are more powerful than those available in the sixties—and then you can go into your closet and hole up and not talk to the rest of the world. In the sixties you were very visible when you were on a machine.

Steve: The person who wanted to be on next was over your shoulder.

Tom Knight: Yes, and they had very strong opinions about your project and its worthwhileness. This led to a close bond between those people.

Steve Levy: Were the rules strictly adhered to?

Steve Russell: The PDP-1 and other early computers had a sign up list and you could sign up for an hour in advance, and there were rules for parcelling this out. When your time was up, you had about 5 minutes of leeway and the pressure increased, especially because the next person usually showed up early. So you got about 10 minutes of design review after your had finished your work.

Tom Eggers: There was always a fight for the extra hour of computing when we went off daylight savings time.

Tom Knight: The machines ran 24 hours a day. Seven a.m. was quite good, as it was a change between night and day phase.

Mike Beeler: Night phase started with a large dinner, followed by working through the night.

Steve Levy: What was it that made you work so hard and forget about going to class? Many hackers from that era didn't bother to get a degree.

Alan: I didn't suffer from that problem because I wouldn't get next year's stipend. A lot of pressure from my Jewish mother.

Steve Russell: The phenomena of discovering computers and flunking out is no different from the people who discover drama clubs, music, model railroads, or other manias.

Steve Levy: That's the marching band excuse. When I did my first article on hackers, I thought it was different.

Marvin Minsky: Students knew more than their professors about computers.

Gordon Bell: People are obsessed with hardware/software machines because they are animate objects that are extremely complex and often a new unexplored territory of problems. You could tell a good hack. When I taught programming, I'd look at the code and often say to the student, "Do the world a favor. Make sure that you don't write anymore programs." Hackers understood elegance and lived for the creation of machines.

Tom Knight: I think a number of things were happening then that aren't happening now, namely, getting the computer to do things for the first time—to present a Minskytron or a Spacewar or whatever. Further, hacking was the only way to learn computing. Today you can take a course—they're not great.

Mike Beeler: The newness today is different. In the sixties we were isolated; today large numbers of isolated people are working on the same problem with the same tools. A new compiler, a new adventure game, and a new Pascal—all on personal computers, nothing on a mainframe. Today repackagers of the hackers' programs can make a bundle of money off it; I don't like the ego investment of doing something for others profit. In the old hacking sense the ideas were "free".

Steve Levy: Richard Stallman, the last of the hackers, wants to say something.

Richard Stallman: You can do what I do: copyright the material, distribute it, and don't let anyone else sell it. Then everyone puts their efforts into the common pool.

Gordon Bell: Are all the EMACS (a text editor) yours?

Richard Stallman: No. There are two EMACS companies, but I think I may put them out of business. These are not my programs, but imitations of them. I think they are wrong, not because copying me is wrong, but because it is wrong to hoard programs. They are not hurting me; they are hurting everyone. I've been

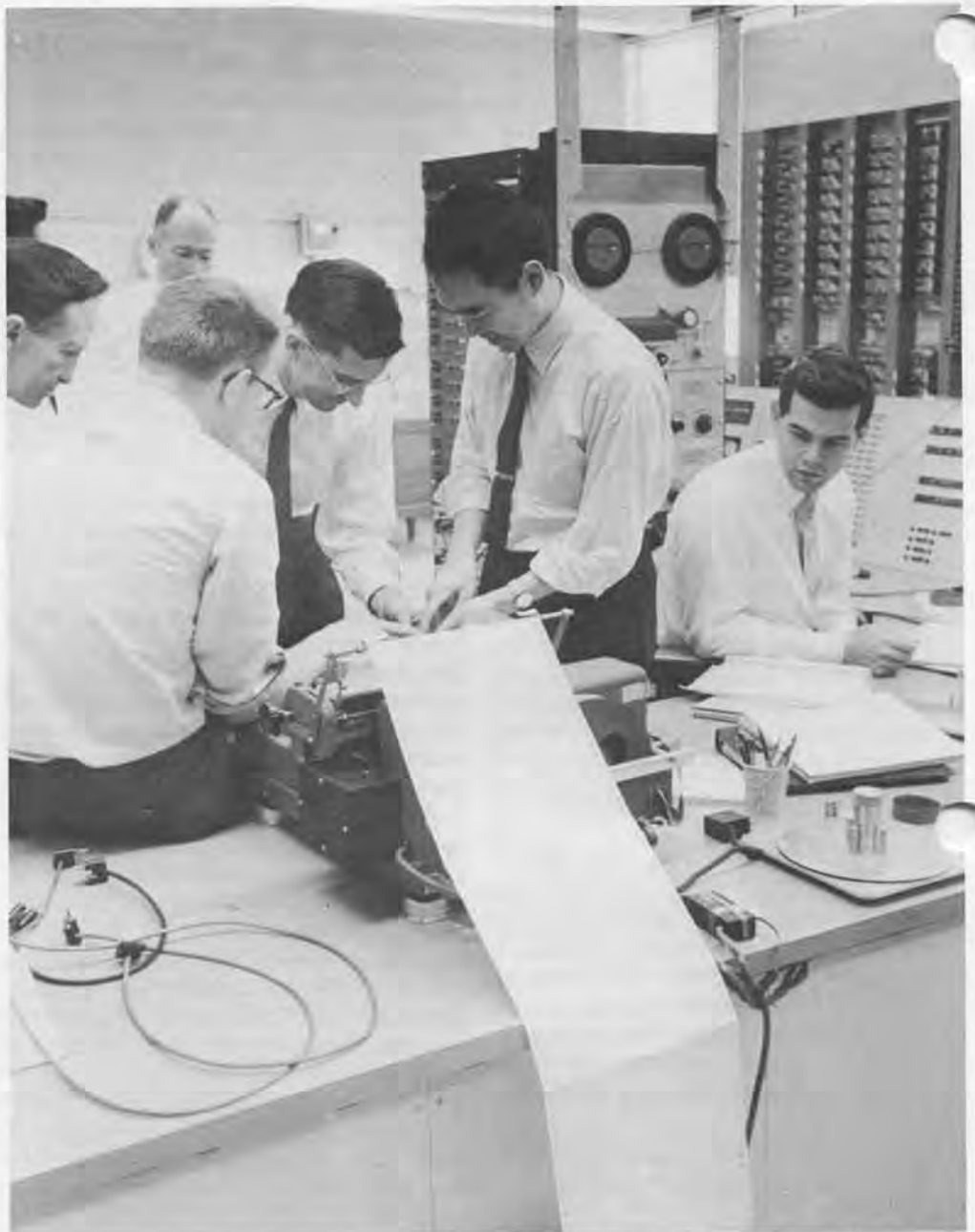

At work on the TX-0 at MIT in the 1960's (left to right): John McKenzie, Gordon Bell, Arthur House (in background), Ken Stevens, Hiroya Fujisaki, Peter Brady. (Photo courtesy of The MIT Museum)

working on an EMACS that will run on NIX and I'm going to give it away free so that the market for the costly programs will dry up.

Steve Levy: In the sixties, people weren't paying for programs. A program as innovative as SpaceWar today would be worth seven figures, but it was a free commodity at the time.

John McKenzie: In 1975, lawyers came into MIT and asked me about SpaceWar. They asked if I could prove it. In the meantime I found the PDP-1 log book that held comments about the winners and losers of the game. The end result was a deposition for a hearing with two lawyers from Bally and two from Magnavox (who was trying to tie it up); in addition, lawyers from Atari and Sanders sat in. It took three days, including explaining the schematic drawings of the PDP-1. That was settled out of court. The sequel of this story is that this year, the lawyers are around again on the same subject with the same principals.

Alan Kotok: They're coming to see me next week.

Tom Eggers: By virtue of dropping out of MIT while hacking on the PDP-1, writing DDT all hours of the day and night, my choice was working for DEC or the Army. Gordon told me I could have a job but I had to finish MIT. I said, I can't. He paid me \$500 for DDT I'd written so far.

Alan Kotok: Probably one of the first programs sold.

Tom Eggers: I had never heard about selling programs, but when I had a chance for the money so that I could pay off MIT for the term that I never took, I just took the money. The issue of ethics never crossed my mind.

Richard Stallman: Did that become the DDT used at the AI lab?

Tom Eggers: Yes.

Richard Stallman: Although DEC may have paid you \$500, it didn't become a hoarded program.

Tom Eggers: It was distributed with the PDP-6.

Tom Knight: In those days, the manufacturers delivered all the software that existed.

Steve Russell: There was no market for software. No one that had a computer paid any money for software.

Steve Levy: After Slug finished SpaceWar, it was used, copied, and improved over and over. There was no such thought as copyright.

Marvin Minsky: Eventually, SpaceWar was banned for daytime use.

Steve Russell: They put up rules for playing SpaceWar. The rules included that playing the game was lower priority than making new versions.

Tom Knight: In the early seventies, Jim Pitts at Stanford bought a PDP-11 and decided to commercialize SpaceWar. He installed it as a game in one of the Stanford sandwich shops and promptly lost lots of money. This is an example of trying hard to market something and failing miserably.

Steve Russell: Cinematronics on the Westcoast marketed SpaceWar, Asteroids and several derivations with a standard four button control. The only remarkable feature is "viscous space," so that you can slow down by stopping to accelerate, not realistic but interesting for the players.

Alan Kotok: While it only took a couple of people to get SpaceWar going, think of the number of lawyers who have been deployed on the job. No wonder that we have to graduate more lawyers than engineers.

Steve Levy: One criticism is that there were no efforts to get the world at large involved with what the hackers were doing.

Tom Knight: The computers cost a million dollars—and how could you excite the public about something like that.

Marvin Minsky: At the time we started the artificial intelligence lab most people didn't believe that it could exist. People didn't believe that machines could play chess, even after they had beaten people thoroughly. This drew the A.I. people together as a circle facing the world. It took many years to convince industry to adopt timesharing. Generally people don't adopt new ideas, that's the way it is in civilization.

Steve Levy: I heard that even the hackers resisted timesharing.

John McKenzie: They certainly resisted video screens, believing that everything had to be done in hardcopy.

Marvin Minsky: And they certainly resisted lower case.

Tom Eggers: Hackers were elitist. The word "user" was often alliterated to "loser". If you weren't a hacker and couldn't "hack," then you were on the outside.

Steve Levy: The West Coast group that started the drive to personal computers

thought of the A.I. labs as elitist. People who didn't care if computers were used. In fact, the computer people didn't even think that the Altair or the Apple I were computers that would lead anywhere and so were ignored. Is this accurate?

Tom Knight: A very accurate perception.

Marvin Minsky: The problem they were working on was how to put bigger programs into 8K machines. At that time, AI was working beyond the 64K barrier and this was what was interesting to the community.

Tom Knight: I remember working in the LOGO lab and discussing whether we should write one for the Apple. We said, "No, it's really too small." We saw it was twice as big as the largest memory for the Apple. But we didn't see that if we spent a year writing the program, then the Apple would be large enough.

Marvin Minsky: We finally got a LOGO into 1K, but it was hard.

Alan Kotok: Two thoughts about memory size: the power supply computer for the latest VAX is probably more powerful than the TX-0; the memory of the system, 32 mbytes, was larger than the entire memory of all the computers in the world when I started.

Steve Levy: Because hackers had disregard for the rules, will the examples provide a bad example?

Alan Kotok: If motivated people who will build great things have to break a few locks, that's the price.

Gordon Bell: There's a difference between fundamental thievery and needing a component in the middle of the night and finding an interesting way to get it.

Steve Russell: Elegance is getting done what you want to do without exciting or interesting the people who might catch you.

FROM THE COMPUTER MUSEUM STORE

"I WANTED TO COME HEAR ADAM OSBORNE BUT . . ."

If you wanted to come to the Computer Museum to hear one of our fascinating speakers but were unable to, you can now order audiocassette recordings of some of the talks.

In cooperation with Powersharing, a producer of computer-related audiocassettes, The Computer Museum is offering a mini-series of recordings within the broader collection offered by Powersharing. Each cassette costs \$5.95 (members \$5.35).

You can select from an impressive line-up of talks by high-technology luminaries and pioneers such as:

- Regis McKenna's scintillating talk on establishing market share in a world-wide economy. McKenna has been called "the marketing guru of Silicon Valley," being partly responsible for Apple's early rise and the successes of INTEL.
- Adam Osborne's witty and insightful discussion of the new economics of software development. Osborne draws on his experience in publishing and the notorious demise of Osborne Computers in describing where he sees software products and prices going in the next decade.



Osborne & Osborne—Adam Osborne poses with the Osborne I (to left) in the PC Gallery at the Museum following his talk on March 3, 1985. (Photo: Peter Cassidy)

- Martin "Shag" Graetz and Alan Kotok tell how their shared passion for sci-fi movies, strategy games and computers evolved into the development of SpaceWar!, reputedly the world's first computer-based video game.

Also available are other selections from the Powersharing Series:

- Steve Wozniak's humorous and remarkably candid talk about how he realized his boyhood dream of having a computer for himself and for millions of others. Adults will enjoy this tape, but so will all the children who are using Wozniak's computer in the nation's schools.
- M.I.T.'s Professor Seymour Papert, widely regarded as the father of the computer language LOGO, talks about how profoundly computers may change the way our children are educated, particularly outside of traditional classrooms.

Just indicate the cassette of your choice (by speaker) on the coupon below.

NEW COLOR SLIDES SERIES AVAILABLE

Now you can add some full-color pizzazz to your lectures and talks with The Computer Museum's new color slides series illustrating the development of computing devices. The expanded set is comprised of 48 35mm slides, divided into twelve groups of four.

We've found that the set appeals especially to middle, secondary and college instructors of mathematics, physics and computer science. Many computer industry instructors also use them for in-house training programs.



Take a few minutes to look over the list to see which interest you. The entire package of 48 slides (Groups 1-12) is available for \$45.00 (members \$40.50). Each group of four slides is \$4.50 (members \$4.05). Sorry, slides are not available individually or for reproduction.

- Group 1: Information Processing History Graphs and Charts
- Group 2: Early Calculating Devices
- Group 3: Hollerith's Tabulator and Sorter for the 1890 U.S. Census
- Group 4: M.I.T.'s Whirlwind Computer (1945-1953)
- Group 5: Early Computers
- Group 6: Supercomputers
- Group 7: Logic Technology
- Group 8: Memory Technology
- Group 9: History of Integrated Circuits
- Group 10: History of Integrated Circuits (continued)
- Group 11: History of Integrated Circuits (continued)
- Group 12: Evolution of Personal Computers

ORDER FORM

NAME	DAY PHONE		
ADDRESS			
CITY	STATE	ZIP	

Mail your order to: The Computer Museum Store 300 Congress Street Boston, MA 02210

Method of Payment Minimum charge order: \$15.00 <input type="checkbox"/> Check or money order enclosed (no COD's) <input type="checkbox"/> Visa <input type="checkbox"/> Am Ex <input type="checkbox"/> Mastercard Interbank No. <input type="checkbox"/> <input type="checkbox"/> <input type="checkbox"/> <input type="checkbox"/> (Mastercard only)	_____ Card Number _____ Signature	_____ Exp. date:
---	--	---------------------

QUAN.	DESCRIPTION	UNIT COST	TOTAL

Please add \$2.50 to cover postage & handling charges for the first item ordered; add 50¢ for each additional item.

Please check here if Museum member.

Thank you. Your purchases help to support the Museum.

SUBTOTAL	_____
MASS. 5% TAX	_____
SHIPPING	_____
TOTAL ENCLOSED	_____

The Computer Museum Program Series

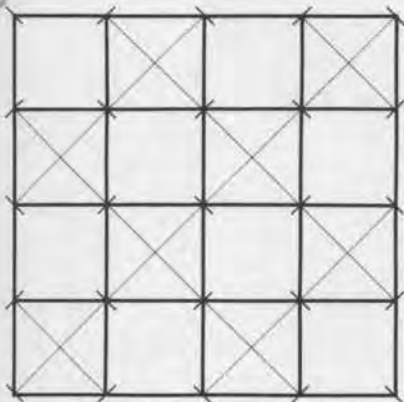

Thursday, May 2—7 p.m.

Dr. Koji Kobayashi, Chairman, NEC Corporation

The Development of the Japanese Computer Industry

Thursday, May 16—7 p.m.

COBOL's 25th Anniversary: The Story of the COBOL Tombstone

CODASYL members John L. Jones, Commodore Grace M. Hopper, Thomas Rice, Oliver Smoot, Jan Prokop and Donald Nelson will tell the story of COBOL's development and those who thought that a machine universal language would never survive.

Sunday, May 19—4 p.m.

The Human Factor: Designing Computer Systems for People

Why are some computer systems such a pleasure to use, while others are not? Authors Dick Rubinstein and Harry Hersh will show that the design of good human/computer interfaces isn't a black art.

Sunday, June 2—4 p.m.

A Museum Overview with Maurice Wilkes

Mr. Wilkes developed the EDSAC, the first stored program computer, and has played a role in many other advancements in computer technology. He will talk about many of the computers exhibited in the Museum. His memoirs will be published by MIT Press in June. A Members Reception will follow the talk.

The Computer Museum Attic Sale and Antique Show

Get your hands on computer gadgetry, antique calculating devices, mathematical instruments, photos, graphics, books, manuals, and more at the Museum's "computer flea market"—a real hacker's dream.

**Saturday, September 21
6 pm**

Benefit Preview Party and "Private Sale"
\$20 members; \$30 non-members

**Sunday, September 22
11-6 pm**

Attic Sale and Antique Show
4 PM—Panel discussion on "computer collectibles"

Clean out your attic with contributions for the Museum—fully tax deductible. One hacker's throwaways are another's key parts, so mark your calendars!

Also, vendor tables will be available for rent. Please call Majie Zeller for more information, (617) 426-2800 ext. 339.



THE END BIT 000000001



Cambridge, Mass., February 25—The Air Force announced today that it has a machine that can receive instructions in English, figure out how to make what is wanted, and teach other machines how to make it.

An Air Force general said it will enable the United States to "build a war machine that nobody would want to tackle."

Today it made an ashtray.

—*San Francisco Chronicle*

In a sulk, probably.

—*The New Yorker Magazine* of March 28, 1959 on the first object to be designed by computer and manufactured directly from the computer output.

The ashtray was donated to The Computer Museum by Douglas T. Ross and is on display in the Timeline.

Address Correction Requested

Non-Profit
Organization
U.S. Postage
PAID
Permit No. 110
Fitchburg, MA
01420

The Computer Museum 300 Congress Street, Boston, Massachusetts 02210

THE COMPUTER MUSEUM HISTORY CENTER



1 026 2147 2

THE COMPUTER MUSEUM REPORT

VOLUME 13

SUMMER 1985



Board of Directors

John William Poduska, Sr.,
Chairman
Apollo Computer Corporation
Gwen Bell, President
The Computer Museum
Erich Bloch
National Science Foundation
David Donaldson
Ropes and Gray
Sydney Fernbach
Computer Consultant
C. Lester Hogan
Fairchild Camera and Instrument
Corporation
Sir Arthur Humphreys
ICL

Theodore G. Johnson

Mitchell Kapor
Lotus Development Corporation

August Klein
Masscomp

Dr. Koji Kobayashi
NEC Corporation

John Lacey
Control Data Corporation

Robert Lucky
AT&T Bell Laboratories

Patrick McGovern
CW Communications Inc.

James L. McKenney
Harvard Business School

Carver Mead
California Institute of Technology

William Millard
Computerland Corporation

Arthur P. Molella
The National Museum of
American History,
Smithsonian Institution

Brian Randell
University of Newcastle upon Tyne

Jonathan Rotenberg
The Boston Computer Society

Jean E. Sammet
International Business Machines

Edward A. Schwartz
Digital Equipment Corporation

An Wang
Wang Laboratories, Inc.

Maurice Wilkes
Digital Equipment Corporation

Trustees

Charles Bachman, C. Gordon Bell,
Harvey D. Cragon, Robert Everett,
Andrew Knowles, George Michael,
Robert Noyce, Kenneth Olsen,
Kitty Selfridge, Michael Spock,
Erwin Tomash, Paul Tsongas

Executive Committee

David Donaldson, *Chairman*, Gwen
Bell, Theodore Johnson, August Klein,
Nicholas Pettinella, Jonathan
Rotenberg, Ronald Smart, Oliver
Strimpel, Michael Templeton

Corporate Members

Benefactor—\$10,000 or more
American Telephone & Telegraph Co.*
Apollo Computer, Inc.*
Bank of America*
Bank of Boston
The Boston Globe*
ComputerLand*
Control Data Corporation*
Data General Corporation*
Digital Equipment Corporation*
Hewlett-Packard
Honeywell Information Systems
International Data Group*
International Business Machines, Inc.*
The MITRE Corporation*
Systems Development*
The Travelers Companies
Wang Laboratories, Inc.*

Patron—\$3,000

Adage, Inc.
Addison-Wesley
Bitstream
Boris Color Lab, Inc.*
Burroughs Corporation
Commodore Business Machines, Inc.
Coopers & Lybrand
Datapoint Corporation
DECUS*
Draper Laboratories*
Gatson Snow & Ely Bartlett*
General Computer Co.
GTE Data Services, Inc.
The Honeywell Foundation
IEEE Computer Society
Index Systems*
INTERLAN, Inc.
Intel Corporation
Arthur D. Little, Inc.
Major Computer, Inc.
MASSCOMP
McGraw-Hill, Inc.
Regis McKenna, Inc.*
Microsource Financial
Mostek
National Semiconductor Corporation
NEC Corporation
Nolan, Norton & Company, Inc.*
Prime Computer Corporation
The Prudential Insurance Company
SHARE, Inc.
Software Results Corporation*
Stratus Computer, Inc.
Symbolics, Inc.
Systems Concepts
3Com Corporation*
Venture Founders Corporation

Contributor—\$1,000

Analog Devices, Inc.
American Management Systems*
Autographix
Bolt Beranek & Newman*
Cullinet Software, Inc.
Dane, Falb, Stone & Co.
E.J. DuPont DeNemours & Co.
Ford Motor Company*
General Systems Group, Inc.*
Gould, Inc.
Houghton Mifflin Company*
Hyams Trust
International Computer Ltd.*
Investment Orange Nassau, Inc.
Manufacturers Hanover Trust
Meditech*
Mentor Graphics
Micro Control Systems
Microsoft*
New York Air*
Pencept, Inc.
Standard Oil Corporation
Teradyne
XRE Corporation
ZBR Publications, Inc.

*Also contributed to the
Capital Campaign

Core Members

Harlan E. and Lois Anderson
Charles and Constance Bachman
C. Gordon Bell
Erich and Renee Bloch
Henry Burkhardt III
R. Steve Chehey
Robert C. and Eleanor W. Chinn
Robert G. Claussen
William Congleton
Alex d'Arbeloff
Arnaud de Vitry
David Donaldson
Douglas Drane
Robert Everett
Kenneth G. Fisher
Jay W. Forrester
Gardner Hendrie
Winston R. Hindle, Jr.
Theodore G. and Ruth T. Johnson
John Allen Jones
Mitchell Kapor
Allan Kent
Jack S. Kilby
August Klein
Andrew C. Knowles, III
David J.A. Koogler
Edward and Debbie Kramer
John W. and Edna W. Lacey
Ralph and Linda Linsalata
John Norris Maquire
Richard D. Maguire
Thomas Marill
Daniel D. McCracken
James L. McKenney
Thomas and Elizabeth McWilliams
Carver Mead
Robert M. Metcalfe
Robert M. Morrill
David and Pat Nelson
Robert Noyce
Kenneth Olsen
Stanley C. Olsen
John L. Payne
Edward G. Perkins
John William Poduska
Robert M. Price
Fontaine K. Richardson
Douglas Ross
Jean E. Sammet
Paul and Catherine Severino
Alan F. Shugart
Richard L. Sites
Ronald G. Smart
Charles E. Sporck
Ivan and Maria Sutherland
Del Thorndike and Steve Teicher
Erwin Tomash
Jean De Valpine
Charles P. Waite
Stephen L. Watson
Harvey W. Wiggins, Jr.
William Wolfson

Contributing Members

J.D. Addeleston, Lawrence Adrian,
Kendall Allphin, Timothy Anderson,
Isaac Auerbach, John Banning, John C.
Barstow, G.C. Beldan, Jr., Alfred M.
Bertocchi, Dr. John H. Blankenship,
Philip D. Brooke, Fred and Nancy
Brooks, D.F. Brown, Gordon S. Brown,
Lawrence G. Brown, Roger M. Buoy,
Marshall D. Butler, James Burley, James
Burnett, Maria L. Carr, Charles and
Virginia Casale, Donald Christiansen,
Richard J. Clayton, James F. Cody,
Richard Corben, Howard E. Cox, Jr.,
Michael Cronin, Henry J. Crouse, David
N. Cutler, Gerald Davis and Francoise
Szigetti, Nick De Wolf, Peter De Wolf,
Quentin De Wolf, James B. Deaderick,
Lucien and Catherine Dimino, Dr.
Ditargiani, Philip H. Dorn, Theodora
Drapos, Gregory L. Duckworth, Ray
Duncan, Joseph J. Eachus, Fred
Ebeling, Dr. Richard Eckhouse, Tom
Eggers, Dan L. Eisner, Bob O. Evans,
Robert A. Farmer, Andrew D. Feit, Read
T. Fleming, J. Thomas Franklin, Clark
Frazier, Alan E. Frisbie, Edward A.
Feustal, Corrin Gale, Kevin A. Galvin,
Branko J. Gerovac, David Goodman,
William Graustein, John Griffith,
Dr. Roberto Guatelli, Jerrier A.
Haddad, Michael P. Halter, William
R. Hambrecht, J. Scott Hamilton,
Sheryl Handler, Walter and Catherine
Hawkins, William Helm, Jr., Robert and
Carol Henderson, Robert B. Hoffman,
Thomas L. Hohmann, Nancy S. Horie,
M. Ernest Huber, Bill Hunzeker,
Cuthbert C. Hurd, Michael Jerabek,
Charles A. Jortberg, Richard M. Karoff,
Bryan S. Kocher, Alan Kotok, Stanley
Kugell, Theodore Kuklinski, Raymond
Kurzweil, Robert Laman, Andrew
Lavien, Glen G. Langdon, Jr., John R.
Levine, Michael Levitt, John V. Levy,
Steven B. Lipner, John Lowry, Carl
Machover, Andrew H. Mason, Joe W.
Matthews, Robert Mayer, Jr., Richard
McCluskey, Tron McConnell, F. Warren
McFarlan, Jim McIntosh, Robert W.
McKnight, Todd Medlock, R.W. Meister,
Allen Moulton, Dr. J. Craig Mudge,
Carol E. Muratore, Dr. and Mrs. Isaac
R. Nassi, Cynthia L. Nelson, Stewart
Nelson, Joseph Nestor, Joseph M.
Newcomer, Chuck Newman, Tim K.
Nguyen, Bernard J. Nordmann, Bill
Noyce, James N. O'Boyle, Jr., Anthony
G. Oettinger, John E. Parker, Kenneth
D. Patterson, James and Martha Patton,
Nicholas and Nancy Pettinella, James
H. Philip, Linda J. Phillips, Paul R.
Pierce, Juan A. Pineda, James A. Pitts,
Andrew Plescia, J. Eric Pollack, James
N. Porter, C. Mike Riggles, Ann and
Robert Roe-Hafer, David C. Roh, Peter
R. Rony, Daniel Rose, David Rose,
Jonathan Rotenberg, Martin S. Roth,
Thomas S. Roy, II, Eugene Rudolphe,
Michael J. Samek, Peter R. Samson,
F. Grant Saviers, Edward A. Schwartz,
Oliver and Kitty Selfridge, W. Lee
Shevel, John J. Shields, III, Diane
J. Skiba, Ph.D., Allen G. Sneider, Stuart
Solomon, John R. Spencer, John Stark,
Max J. Steinmann, William M. Steul, J.
Michael Storie, Charles A. Stott,
Howard Sussman, David Tarabar,
Warren G. Tisdale, Michael G.
Tomasic, Sherry Turkle, G. Michael
Uhler, Noah E. VanDenburgh, Christian
Walker, Allan L. Wallack, Joseph B.
Walters, Jr., Thomas E. Welmers, John
D. Wick, Hugh M. Wilkinson, III,
Andrew Wilson, Richard T. Witek,
Frederic and Robin Withington, T.J.
Wojcik, Jr., D.L. Wyse, Jeffrey N. Zack

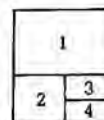

The cover photographs are still frames
from the following computer animated
films (see article on page 4):

1. The adventures of Andre & Wally B.
Lucasfilm Ltd.
2. Snoot and Muttly, Susan Van Baerle
and Douglas Kingsbury
3. Carla's Island, Nelson Max
4. Vol Libre, Loren Carpenter

Contents

1

The President's Letter
Dr. Gwen Bell

**Computer Animation in
the Museum**

Oliver Strimpel

8

**The Story of the
COBOL Tombstone**

10

**Recollections of Memories
from RCA in the Fifties**

Jan Rajchman

14

**Honeywell Animals Find
a New Habitat**

16

**Questions About the
New Exhibits**

17

Fall 1985 Program Series

The Computer Museum

The Computer Museum is a non-profit 501(c)3 foundation that chronicles the evolution of information processing through exhibitions, archives, publications, research, and programs.

Museum Hours: The Museum hours are 10 AM-6 PM, Tuesday, Wednesday, Saturday, and Sunday and 10 AM-9 PM, Thursday and Friday. It is closed Mondays, Christmas, New Years, and Thanksgiving.

Membership: All members receive a membership card, free subscription to The Computer Museum Report, a 10% discount on merchandise from The Computer Museum Store, free admission and invitations to Museum previews. For more information, contact Membership Coordinator at The Computer Museum, 300 Congress Street, Boston, MA 02210, (617) 426-2800.

RossinGreenbergSeronick&Hill
Advertising Consultants

Germain-Lawrence-DRK, Inc.
Public Relations Advisors

Staff

Dr. Gwen Bell, President

Michael Templeton, Executive Director

Dr. Oliver Strimpel, Associate Director and Curator
Robert Carr, Manager of Interpretive Program;
Russell Landers, Floor Manager; Kurt Levitan,
Exhibit Operations Manager; William Wisheart,
Registrar.

Mark Hunt, Marketing Director
Louise Dornitz, Public Relations Manager;
Jessica Pollard, Communications Assistant;
Kathleen Keough, Functions Coordinator;
Marjie Zeller, Editor

Michael Oleksiw, Development Director
Anne Janckes, Development Assistant
Scott Reilly, Membership Assistant

Eva Radding, Business Manager
Debra Cohen, Store Manager; Steve Klinke,
Assistant Store Manager; Nancy Dattoro,
Office Manager; Deborah Goudreau,
Business Office Assistant.

**The
Computer
Museum** 300 Congress Street
Boston
Massachusetts
02210

The President's Letter

When I wrote the first letter in the first *The Computer Museum Report* in May 1982, I was the President, Treasurer, and Executive Director of the Museum. The whole staff consisted of three other people plus some summer students, and there were about 100 members. After a year, the Board of Directors decided that I shouldn't create, write, and sign the checks and Professor James McKenney became Treasurer.

Then this year, the Museum had its first assessment on the way to accreditation by the Association of American Museums. It became equally clear to me that the role of President and Executive Director of an ongoing public museum were indeed different. There was no way for me to do all that I have been doing as President—maintaining a close, ongoing relation with the computer industry—and also be a director of this major museum that is making a significant footprint in the Museum community.

It is with great pleasure that I introduce Michael Templeton as the new Executive Director. Michael was actually the first museum professional to visit the museum! In the fall of 1980, when he was the Executive Director of the Association of Science and Technology Centers, ASTC, he scheduled a meeting at the Museum in Marlboro of their advisory board for the travelling exhibit, Chips and Changes. At the time, he encouraged me to push ahead and develop the Museum.

My next visit with Michael was in Portland, Oregon, where he had become the Director of OMSI, the Oregon Museum of Science and Industry, a Museum that I had long admired. Why? First, Oregon Software originated there. This company was formed by a group of students and their physics teacher, Rusty Whitney, who wrote a Pascal compiler on the PDP-11 in the basement of OMSI. Ten years later the company is alive and thriving. Second, OMSI pioneered in computer-based exhibits and had a very good working relationship with the electronics firms in the Northwest.

At the time of the Museum assessment, I thought that one of the few people in the world who could come in and be in synch with the Museum was Michael Templeton. When I called his home in Portland, I learned that he was consulting at the National Science Foundation. He changed his plans and travelled back to Portland via Boston, walking into the middle of an exhibit planning meeting. Everyone felt that this was a match that was meant to be. I will stay on as President and CEO (in the jargon of industry) and he will be the Executive Director and COO.

The New Trustees

Each year, a class of the Board of Directors retires to become Trustees of the Museum. This year, Gordon Bell, Harvey Cragon, Robert Everett, George Michael, Ken Olsen, Kitty Selfridge, and Erwin Tomash made this step. Gordon Bell and Bob Everett will continue to work on the development committee to ensure that the capital campaign will reach its goal by 1988, Harvey Cragon, George Michael and Edwin Tomash will remain involved with the Collection and Exhibition Committee. Kitty Selfridge, who started the member volunteer organization, will remain an active member of the Museum. And finally, Ken Olsen, who was the first Chairman of the Board, will remain a vital force behind the scenes.

The New Board Members

Seven people were elected to the Board of Directors, each bringing special talents and perspectives to the table.

Sir Arthur Humphreys, retired Chairman of ICL Ltd., renews the Museum's connection with The Charles Babbage Institute, of which he is a trustee, and strengthens our international ties.

August Klein, President of MASSCOMP, has come on board as the Chairman of the Museum's capital campaign. In Gus's words, "I don't just join an organization, I



Michael Templeton



August Klein

Robert Lucky



Carver Mead



William Millard

Jonathan Rotenberg



Maurice Wilkes

invest in it." His experience comes from both business and philanthropy: he was a 25 year employee of IBM and served as a director of United Way in Greenwich, Connecticut, Denver, Colorado, and Jacksonville, Florida. Gus is establishing a committee to meet our March, 1988, deadline of \$10,000,000. He also says, "Hey, I'm delighted to start with one-third of the goal in our pocket."

Robert Lucky, Executive Director of the Research, Communications Sciences Division at AT&T, is a Fellow of the IEEE, a member of the National Academy of Engineering, and a member of the Advisory Committee of the National Science Foundation. He will help the Museum develop its collections, exhibitions, and publications on the subject of communications and computers.

Carver Mead, Gordon and Betty Moore Professor of Computer Science at Cal Tech, views the microprocessor as computer. He is spearheading our efforts to "get the semiconductor story right." This leads the Museum in the direction of collecting and exhibiting the evolution of chips and how they are made.

William Millard, Chairman of ComputerLand, was part of the firm that developed the groundbreaking IMSAI-8080 microcomputer. Watching the early growth of the IMSAI dealer network, Bill Millard established ComputerLand in 1976, a franchise network that provided financial and business experience to computer retailers. He is personally interested in both history and the future. Reflecting these interests, he has established a ComputerLand competition for the earliest microcomputer artifacts donated to the Museum. He will also spearhead a long range planning committee for the Museum.

Jonathan Rotenberg is President and Founder of the Boston Computer Society, the largest one of its kind in the United States. His longtime dream has been to establish a computer discovery center—an idea that extends the museum exhibit plans. He will work with us to build the computer discovery center into the Museum.

Maurice Wilkes built the first, operational, full-scale stored program computer, the EDSAC, and gave the very first Computer Museum Lecture, making him a bona fide pioneer not only in computers but in the establishment of this Museum. Maurice, a senior engineer at Digital Equipment Corporation, is extraordinarily interested in the preservation of both the software and hardware that laid the foundations for the industry. Parts of the EDSAC, languishing in the basement of the Science Museum in London, were sent to us for exhibiting. His contributions will help us develop historical exhibitions planned for next year.

The new Board members have a diversity that reflects that of the Museum. Our exhibits contrast state of art with historic firsts, include the stories of individuals and corporations, and encompass all the levels of integration from silicon to software.

The future of the Museum will continue to evolve. The new executive director and new class of directors renew our activities. Personally, my role will again change as the Museum becomes broader and deeper. And I'll be around and willing to do what is needed to make the Museum great.

Gwen Bell
President

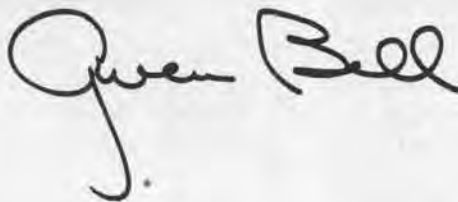
A handwritten signature in black ink that reads "Gwen Bell". The signature is written in a cursive, flowing style. The first name "Gwen" is written in a larger, more prominent script, and "Bell" follows in a similar but slightly smaller script. There is a small dot at the end of the signature.

Computer Animation in the Museum

by Oliver Strimpel

Film and video animated by computer are an important record of hardware and software development. The need to produce large numbers of images and to animate them smoothly absorbs a large amount of computer time and fully exploits all the available spatial and color resolution of computer graphic systems. Makers of film and video have consistently stretched their resources to the limit.

The Museum is building up a collection of computer-animated film and video. An important recent acquisition is a set 12 films donated by Ken Knowlton made at AT&T Bell Laboratories between 1963 and 1976. The computer (an IBM 7094) was used both to draft the images on a microfilm recorder (a Stromberg-Carlson 4020), as well as to calculate what should be drawn. A short piece by Ed Zajac that simulates the

oscillations of a communications satellite in the Earth's gravitational field was completed in 1963, making it the earliest computer generated film known to the Museum. Several of the films are educational, visually explaining subjects such as Bell Labs' own movie-making system, programming languages, and Newton's laws of motion and gravitation. Others explore human visual perception using images with random noise, and still others use the medium for its aesthetic possibilities.

Another significant set of computer-animated films were donated by F R A Hopgood. He led a group who used the Atlas computer at the Rutherford Laboratory in England to develop a convenient high-level computer animation system from 1968 to 1973. The Museum's films explain concepts in computing and physics, but non-technical entertaining

films were also made. The system was later developed into a package called ANTICS which continues to be used today, particularly in Japan.

Also in the collection is a record of the first real time animation, a simulated flight of the Apollo LEM. This was filmed from the screen of an Adage Graphics Terminal in 1967.

The Museum has created a mini-theater in "The Computer and the Image" gallery to screen some of the more recent pieces in the computer animation collection for the public. Five pieces spanning the development of the art were selected for a 20 minute program which shows continuously. Each piece demonstrates creative and original use of the techniques of computer animation.

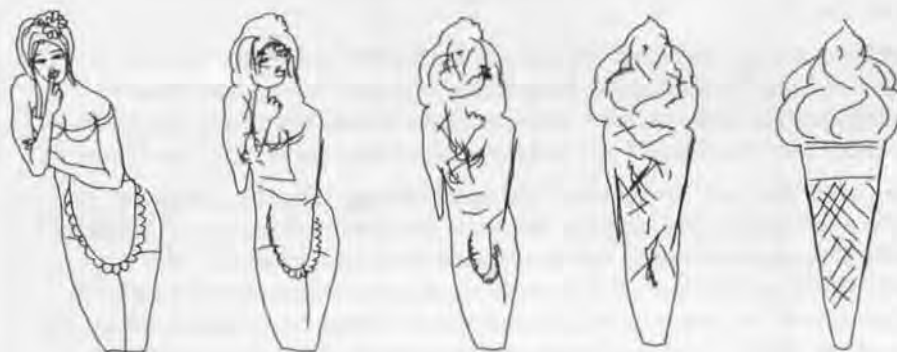

Computer key frame inbetweening is the process whereby the artist only draws the frames that represent the end of a movement or the completion of a metamorphosis. The computer automatically computes and draws the intermediate frames. Here, the artist drew the first and last pictures of the series using a tablet connected to a computer, and the machine generated the frames in between. When seen as moving film, the metamorphosis appears continuous.

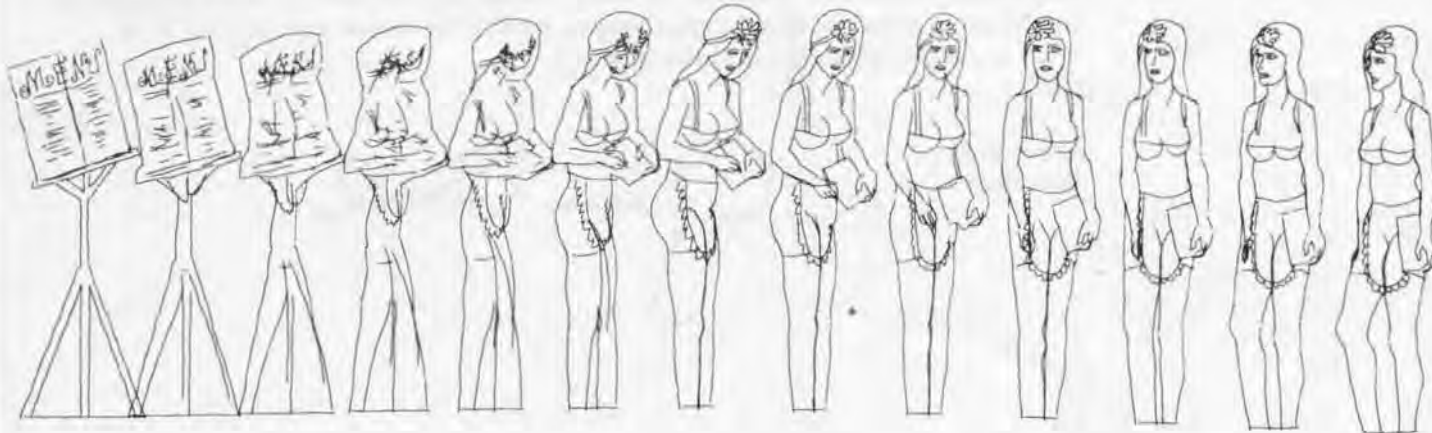

Hunger (1975)

by Peter Foldes

National Research Council, Ottawa,
Canada and National Film Board
of Canada

Hunger is the first film to use the computer to animate hand-drawn images. It shows a man with an insatiable appetite devouring a huge quantity of food. He is then tormented by nightmares in which hordes of starving people devour his own body. The freedom offered by computer animation is used to its fullest extent to convey the film's disturbing message. For example, as he eats, the man's body steadily becomes more inflated and numerous mouths appear to help him eat faster. His visions are graphically portrayed, as in the woman metamorphosing into an ice cream cone.

The technique used is known as "key frame inbetweening." In traditional animation, the animator draws key frames while assistants laboriously draw intervening frames to make motion appear smooth. But in this film, the 'veens' were drawn by computer. The machine works out the intermediate frames by taking averages of the initial key frame and the final one. In *Hunger* the interpolation is linear, which means that the motion starts off jerkily and progresses smoothly till the end-point is reached. Naturally, animators wish to control motion. Contemporary 'tweening' systems now allow many types of movement to be simulated. The most common requirement is to start off slowly, accelerating gradually, and then slow down to a stop. Real living characters generally follow this type of motion.

Vol Libre (1980)

by Loren Carpenter

In *Hunger*, all the key frames are line drawings created by the artist. The computer smooths the passage between these frames. In *Vol Libre*, the computer is used to generate all the images—indeed the images are so complex that they could not be drawn by hand. The film shows a flight through an imaginary landscape of mountains, valleys and lakes. As the landscape is synthetic, the viewpoint can be moved freely, simulating truly free flight.

The landscapes were simulated using a class of mathematical objects

termed fractals by their discoverer, Benoit Mandelbrot. Many natural phenomena, such as clouds, rivers, coastlines, turbulent flow, and capillary networks can be modelled as fractals. *Vol Libre* is the first film that used fractals to simulate a landscape. It also showed that such an artificial landscape could be viewed from several angles and still appear self-consistent. This is not obvious, as the landscape surface is not a real entity, and only the visible portion in the 'camera' is calculated for each frame.

The film received a standing ovation when it was first shown at the ACM SIGGRAPH conference in 1980. Despite images that are crude in comparison to today's, the film is true to its name, conveying an exhilarating sense of liberation from the shackles of gravity and inertia.



View of mountains in a fractal landscape. To create the landscape, Loren Carpenter started off by entering 180 altitude points. These points were connected, giving an initial database of 300 triangles to represent the landscape. The computer then used a random process to assign a midpoint for each triangle, either above or below the plane of the triangle, and connected the

Carla's Island (1980)

by Nelson Max,

Lawrence Livermore
National Laboratory

Nelson Max made the first attempt to model the appearance of moving water for the film *Carla's Island*. A range of simulated lighting is shown on the water surface, from broad daylight to moonlight.

Ray-tracing, modified by some time-saving short cuts, was used to render the play of light on the rippling water surface. During the sunset and rising and setting of the moon, a single cycle of water wave motion was repeated many times, but the colors were changed by altering the color table. This meant that there was no need to recalculate all the reflections. The results worked out for one set of colors were



edges with the new midpoint to make three new, smaller triangles. The process was repeated until the triangles were only a couple of pixels across. The splitting was carried out afresh for each viewpoint.

reused for a different set, chosen to shift towards the colors of sunset and then moonlight. The effect is convincing, and only required a very small amount of extra computer time for a considerable extension in the length of film.



The water surface is modelled by a collection of travelling sine waves. To calculate the lighting, a simplification of a rendering technique known as ray-tracing is used. In ray tracing, the computer follows individual light rays backwards from the viewpoint, reflecting or refracting them off objects in the artificial scene until they hit a light source, matte surface or fade. The destination of the ray is used to work out the ray's contribution to the image. As a ray has to be followed for each pixel of the image, ray tracing is very demanding of computer time. As a short cut, the rays in Carla's Island are only followed for a maximum of 2 reflections on the water, and then assumed to originate from whatever they point to. It still took a Cray-1 supercomputer 7 seconds to compute each 512 by 384 frame.

Snoot and Muttly (1984)
by Susan Van Baerle and
Douglas Kingsbury,
Ohio State University

Snoot and Muttly are two bird-like creatures who play together in a rainbow colored world under trees and floating bubbles. Three types of animation are used. The tails, necks and legs of the animals not only move but change shape as they walk. Taking the legs, for example, the animator input the positions of the hip, knee and ankle for five key positions during a step. The com-

puter then interpolated between the positions.

The heads, feet, eyes and beaks are animated by normal key frame animation, following a smooth rotation without changing shape between the key positions. Finally, the bubbles were placed randomly on a grid and were then moved both systematically to simulate a wind or natural buoyancy, as well randomly between themselves. The computer smoothed the movement between the grid points.

Snoot, Muttly, the bubbles and the trees are rendered with a smooth-shading model simulating sunlight.



Snoot and Muttly are constructed using simple shapes: the bodies are ellipsoids, the necks, tails and legs are tubes, and the head and eyes are spheres. Despite this crudeness, the creatures are convincing and full of character owing to their movement. Successive key frames are shown in these pictures.

André & Wally B. (1984)
by Steven Baraniuk, Loren Carpenter,
Ed Catmull, Rob Cook, Tom Duff, Craig
Good, John Lasseter, Sam Leffler, Eben
Ostby, Tom Porter, William Reeves,
David Salesin and Alvy Ray Smith of
the Computer Graphics Project, Lucas-
film Limited

This 1.8 minute film is presently the most sophisticated piece of computer animation. It opens with a sunrise shot of a magnificent forest, zooming in to reveal an android, André, waking up and stretching. Soon he is confronted with an aggressive-looking bee, Wally B. In classic Disney cartoon style, André momentarily diverts the bee's attention and then flees with Wally in hot pursuit.

André and Wally B. were created on a computer by a Disney-trained animator. Using a tablet and a vector display, he input the characters by hand and then used the computer to animate them. In order to give him the necessary freedom, 547 independent controls were needed for the model of André, 252 for Wally B. Careful attention was given to the interface so that the animator could make use of the available flexibility without becoming aware of the complexity of the computing task.

Once the vector version was complete, the characters were rendered with color and texture and added to the forest backgrounds. For the first time in computer animation, motion blur was added. Without motion blur, sharp edges of animated characters tend to 'strobe', or double up. By deliberately blurring moving objects as if they were moving with the camera shutter open, the strobing disappears and the motion looks more realistic.

To create even this short clip occupied many months of the entire computer graphics research team at Lucasfilm. The huge computer processing needs were met by 10 VAX 11/750's, including those of Project Athena at MIT, and Cray XMP-2 and XMP-4 supercomputers of Cray Research.

The Museum is continually collecting computer animation. The Computer Animation Theater is a showcase of the collection, changing each year to display new pieces. Acquisitions include early work going back to the 1960's, as well as very recent material selected from the film show at each year's ACM SIGGRAPH conference, the prime forum for this medium. This year's selection will be on show at the Museum by this fall.

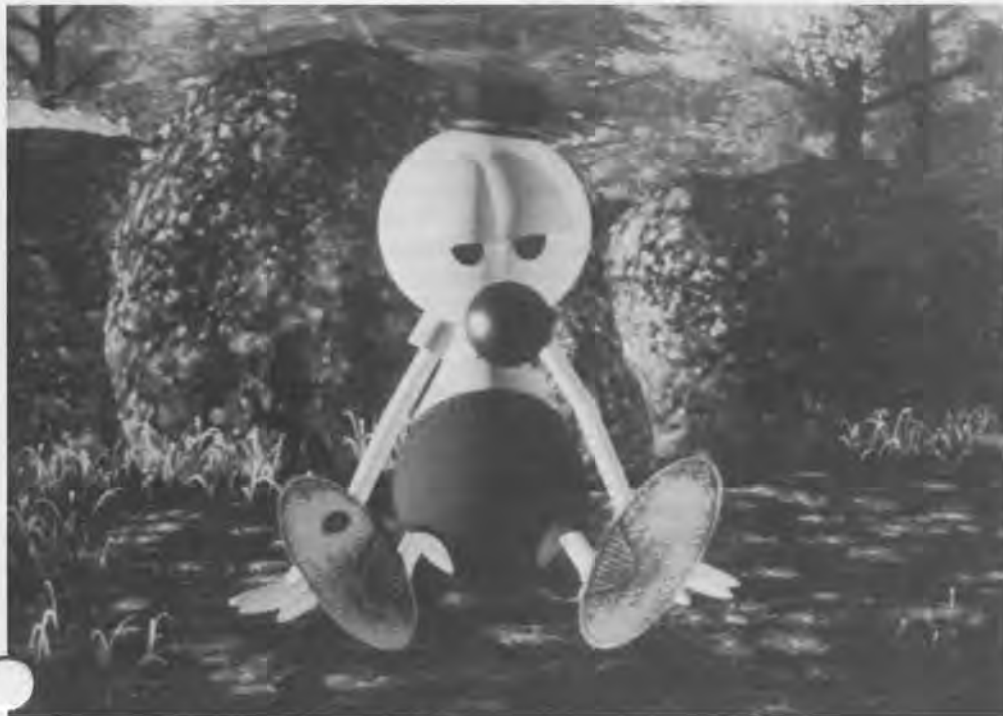

André waking up in the forest. André is a full three-dimensional model. He and Wally B. move in a forest background generated from a 3-dimensional database of 46,254 trees. These were made using particle systems which, rather like fractals, have the property that with a simple starting set of data, complex natural-looking shapes can be generated by repeatedly applying a simple set of rules.

The Story of the COBOL Tombstone

The following is a transcript of COBOL's 25th Anniversary Celebration at The Computer Museum on May 16, 1985.

John L. Jones, Chairman of the CODASYL Committee: The fact is that no one has ever admitted any involvement in the Tombstone. Furthermore, no one has ever explained the meaning, intent, and thought behind the Tombstone.

Let me explain that COBOL and the CODASYL Committee are alive and well and have never had to make use of this tombstone. Both are strictly voluntary committees; in fact all of the work is done by volunteers and always has been done that way. We work on actual language development, refinement and clarification.

One of the key concepts of COBOL was Flowmatic, an idea that was developed by Commodore Grace Hopper. Flowmatic had one other derivative from an Air Force Project, the Air Material Command Compiler, "AIMACO," that was, as far as I'm aware, the first effort to take one language and apply it to efforts on two very different machines, the IBM 705 and the UNIVAC 1105. The compiler ran on the UNIVAC 1 and developed programs for the binary 1105 and the decimal 705. That was another inspiration to begin COBOL.

In 1953-54, most people wanted to program in machine language. The idea of compilers, like the first idea of power steering in automobiles, was intensely resisted: you lost the "feel" of the machine just as you might lose the "feel" of the road. I worked quite a bit with Grace at that time, talking about a compiler "A0" that she had written. In my 1954 Master's thesis I quoted her about using networks of small computers to perform functions that at that time were limited to big computers. Then, this quote about what we now call "distributed processing and micros" was used in the IBM anti-trust case around 1980.

Grace Hopper: When I started, I just went ahead with the idea. I have later learned that it is much easier to apologize than to get permission. In the case of Flowmatic, we discovered that a lot of people hated symbols, even though the mathematicians and engineers loved them. These people used words. We proposed that we should write programs in English statements providing a compiler that would translate to machine

code. I was told that this couldn't happen because computers don't understand words. I said that they didn't have to; they just had to compare bit patterns. "Add" has just as many bit patterns as a plus sign does. But I was getting nowhere. So we acted on the motto: Just go ahead and do it. The lesson that we learned from COBOL is that you must go ahead and do it and make it work, and then get out and sell it.

Donald Nelson, Chairman of the COBOL Committee: The size of specifications of COBOL has grown from a stack of pages three-quarters of an inch high to a stack four inches in thickness. About 60 percent of the programs that exist are written in COBOL, and on mainframes it's about 70 percent. The language has evolved over the years to meet many of the criticisms about it. Suggestions and revisions can be made by any group and are then reviewed by the committee.

Jack Jones: Howard Bromberg was very involved in COBOL from the beginning. The first demonstration that Grace's COBOL compiler worked on different machines was done on a UNIVAC 1 and then Howard's on an RCA 501.

We are missing Charlie Phillips, who recognized the idea of COBOL when he was in the Defense Department, and put his energy behind it to make it happen. In 1959, his efforts made COBOL come to life. His untimely recent death was very unfortunate and we sincerely miss him on this occasion that he was looking forward to.

Howard Bromberg: I thought a long time about the Tombstone and whether tonight was the appropriate forum to come clean. Let me set the background.

During the formative days, the COBOL activities represented the primary computer manufacturers of the time. A handful—8 manufacturers—and a double handful of computer users were represented. At that time we were attempting to create a specification for a language that would be understandable by users, translatable by machines and easy to learn. We were also concerned that the language would be acceptable on all computers, even though there weren't that many back then.

Having worked with Grace Hopper, I subsequently worked for RCA carrying her banner and using the techniques that she taught me. I was the corporate representative to the COBOL committee and the manager of the Automatic Pro-

gramming Group. This group at RCA was creating an embodiment of the COBOL language specifications in our hardware. We kept about one week behind the COBOL language committee. When we moved a week ahead of the committee, I got nervous. RCA wanted to commercialize COBOL as a product, to have a marketing edge. The other manufacturers were seeking the same goal. As a result we sometimes became testy with one another, and with the organization running the activity. The Committee would meet every six weeks, with each member having very specific technical assignments. The meetings would last three to four days and then we would return to our companies to scheme and work.

One Friday afternoon about 3 o'clock I had an opportunity to discuss my frustration with the chairman of the CODASYL committee, Charlie Phillips. He was the coordinator of everything, good and bad. As such, he was the recipient of a lot of verbal abuse and, later on, a lot of praise. I discussed with Charlie the speed of specification of COBOL. After I described, in colorful language, how I felt and the problem... that this was causing me and my company, suggesting that he do something "with it," I hung up and left work in a fit of pique.

As I drove down the freeway, I saw, to my surprise, a monument company next to an exit. Easy off. Easy on. So I did the easy off.

I went in and said, "I'd like to buy a monument."

The salesman said, "You've come to the right place. What did you have in mind?"

"A serious monument that would show my appropriate respect. Since I have to send it, I would like it to be compact." He stepped back and let me wander around. I chose that tombstone because I liked the sacrificed lamb effect.

Mind you, when you buy a monument, it is blank. So the clerk asked, "And what name do you want inscribed?"

I said, "I'll write it for you." I wrote the name down: COBOL.

"What kind of name is that?"

"Well it's a Polish name. We shooened it and got rid of a lot of unnecessary notation."

"Fine. Give me the money and come back in two weeks."

In two weeks I returned, still in a fit



Howard Bromberg and Commodore Grace Hopper share a gleeful moment by the infamous COBOL Tombstone. (Photo: Lilian Kemp)

of pique, mind you. To my surprise, he had gold leafed the name. Today is the first day that I have seen it in twenty-five years and I am still very pleased. Back then, I took it home, not to my office, which is probably the smartest thing that I've ever done. My neighbors helped me build a crate for it out on the sidewalk because they wanted to get it out of the neighborhood. I put my name and home address on it and sent it to Charlie Phillips at the Pentagon and felt better.

Grace wanted me to remind you that I sent it collect.

Now, I have denied this story for years. People would call up and ask me, "Hey, did you send that tombstone?" And I would always respond, "What tombstone?" It appeared in a drawing on the cover of the ACM Communications. More phone calls. I would say, "I don't know anything about it." Grace in her travels used to tell the anecdote. And even more phone calls. But still denial, until tonight.

Back to that time. Two weeks thereafter I had still not heard from Charlie. The fit of pique returned. And I said, "He's doing this to me on purpose." So I called him. We chatted about the weather and other nice things. And I thought, he's got me. Finally I said, "By the way, did you receive something in the mail?"

Charlie Phillips said, "I did indeed. Wonder what you meant by that?"

I said, "Thank you, Charlie." And I hung up.

I was then called to the Vice Presidential suite of RCA where I worked. The suite was interesting because all of the

doors were eight feet tall and the ceilings of the room were twelve feet. I always thought that it was to make the vice presidents feel important and it made me feel very unimportant. After waiting the requisite amount of time, I was ushered into the boss's office. He said, "People at the headquarters in Rockefeller Center have heard that you sent a tombstone to somebody at the Department of Defense. They think this may hamper our ability to bid successfully on defense contracts. Did you do that?"

I said, "Yes."

He said, "Would you like to explain to me why?"

How are you going to explain this to a marketing vice president? So I said, "No."

He said, "Thank you." I went back to my office and sort of organized things, just in case. To their great credit I never heard a word about it again. That also helped my denial to this time. It's here. I did it and I'm glad.

I wondered on the flight out here, whether it really means anything—this hunk of marble. Why are we all here? I guess that it means different things to different people. From my standpoint it shows me the humor that we are able to associate with the work that we were and are doing. . . . the ability to make fun of oneself personally and professionally makes us noble.

COBOL was so different. There were no individuals; they were sublimated to the group. The accomplishment was incredible because we flew in the face of tradition not knowing any better. COBOL "created" a standard.

Standards are usually not created; they are recognized and they evolve. In the next twenty-five years I believe that we will continue to profit from the lesson we learned from COBOL: that a language has to help people talk to people. People do not talk to machines. This is the whole assumption on which COBOL has been built.



Participants in COBOL's 25th Anniversary Celebration at The Computer Museum on May 16, 1985, surround the COBOL Tombstone. Left to right: Ron Hamm, current CODASYL Committee Chairman John L. Jones, Dr. Jan Prokop, Oliver Smoot, CODASYL Secretary Thomas Rice, current COBOL Committee Chairman Donald Nelson, Commodore Grace M. Hopper, Michael O'Connell and Howard Bromberg. Also present were Connie Phillips and Nan Wilson, the daughters of Charles A. Phillips. (Photo: Lilian Kemp)

Recollections of Memories from RCA in the Fifties

by Jan Rajchman

The following is a transcript of Jan Rajchman's talk at The Computer Museum on March 7, 1985, on The Computer Museum Program Series. Mr. Rajchman is the retired Vice President of Research Information Sciences at RCA.

Maurice Wilkes (builder of Cambridge University's EDSAC): I first heard Jan Rajchman lecture at a course at the Moore School in Philadelphia in the summer of 1946. He spoke about the selectron, which was a vacuum tube for storing information, and I admired his ingenuity at the time. Some may think that the pin limitation began with semiconductors, but I can assure you that it started with vacuum tubes.

In the early fifties, I visited Jan at the RCA Laboratories in Princeton where he was working on core memories. I can remember him asking me if I thought that programmers would ever want as much memory as 10,000 words. There was a view then, held by von Neumann, among others, that you didn't need much core memory provided that you had a magnetic drum to back it up.

At that time as today, Jan carried out pioneering work on memory technology and it is with pleasure that I am introducing him tonight.

Jan Rajchman: In 1939, a U.S. Army Colonel visited RCA and spoke of the German superiority in the air and the lack of controllers for U.S. anti-aircraft guns. The mechanical directors for the guns, which had been designed for use on ships and tanks, were utterly too slow for aircraft. The Colonel said, "I don't know anything about electronics except that it's fast, so why don't you look at the problem." The job was assigned to me.

My natural inclination was to look at how the problem was solved mechanically and to do it electronically the same way. After a few months, I discovered that doing anything analog at high speed was very difficult. Very soon I switched to the digital approach with a binary base and the laboratory developed various arithmetical units including shift registers, adders, multipliers, and an arbitrary function generator, now called a read only memory. It also became evident that the digital technique with many tubes would be very bulky and it would take a long time to develop an anti-aircraft fire control de-

vice. At that time, the printing of ballistic tables fell behind the invention of new gun types needing new tables. The idea of one central machine for generating ballistic tables was the origin of what became the ENIAC.

There was some question as to whether the ENIAC could be built at RCA, where we had already done more work, or at the Moore School of the University of Pennsylvania. Frankly, RCA had cold feet. The RCA hierarchy felt that any machine with 30-40,000 tubes would be a monster and would never work. In effect, RCA turned down the job of building the ENIAC. However, we were asked to cooperate, and I went to consult many times. They adapted the read only memory and a decimal rate counter.

While the ENIAC was first tested to make ballistic tables, it quickly became apparent that other problems had higher priority, including some for the atomic bomb. A major issue was how to change the design of the machine from one problem to another. The original ENIAC was designed for a specific problem and then patch cords allowed it to be set up for a different problem. Then people said, "Well, why not relays instead of patch cords?" And from that they said, "Well, why not vacuum tubes? There are vacuum tubes everywhere else." Very, very slowly the idea for the stored program evolved. That is to say, the idea that you could build a machine for any problem without having to know the problem in advance. You could program the machine later to solve the problem. The evolution of this idea took a surprisingly long time. What was missing, of course, was the memory. Obviously the stored program computer has to have a memory for the program and the data.

One of the first ideas (due to Pres Eckert, I believe) was to use a delay line where pulses at one end are detected at the other end, and then are put back at the input. Of course, the more memory there is, the longer one has to wait for any desired bit. It was clear that a "random access" was desirable to avoid this dilemma. The term "random access" was born and I was very unhappy about it. There is nothing "random" about random access memory, because, in fact, the exact address is selected deterministically. I also didn't like the word memory. Memory in animals is more than

storage. I like the way the British put it, an addressable store of information. But the term random access memory stuck.

After the war, von Neumann, who was the great proponent of the stored program computer, undertook to build a machine at The Institute for Advanced Study, and asked RCA Laboratories to provide the random access memory on which it was to be based. That task was assigned to me. In those days, with the triumph of the cathode ray tube in television and oscilloscopes, it was natural to think of using it for a random access memory. Charge is simply deposited on the screen by directing the beam to the selected address where it remains until again bombarded by the beam. Addressing involved analog deflection and storage depended on good insulation of the screen. Many groups (notably MIT) attempted to realize memories in this manner. Most found that structuring the target was necessary. Professor F. C. Williams at Manchester University succeeded in avoiding any such structuring by using a metallization on the outside of an ordinary cathode ray tube and an ingenious use of the naturally occurring redistribution of secondary electrons near the bombarded area. His scheme was a very inventive *tour de force* and provided early memories using commercially available tubes. However, the signals were very weak and the system of analog deflection very delicate. Extreme electromagnetic as well as mechanical insulation was necessary to protect the machine from vibrations such as those due to a passing truck. (By the way, F. C. Williams' ideas were subsequent to those of the Selectron Tube.)



Figure 1. An early RCA cathode ray tube that could have been used for storage.

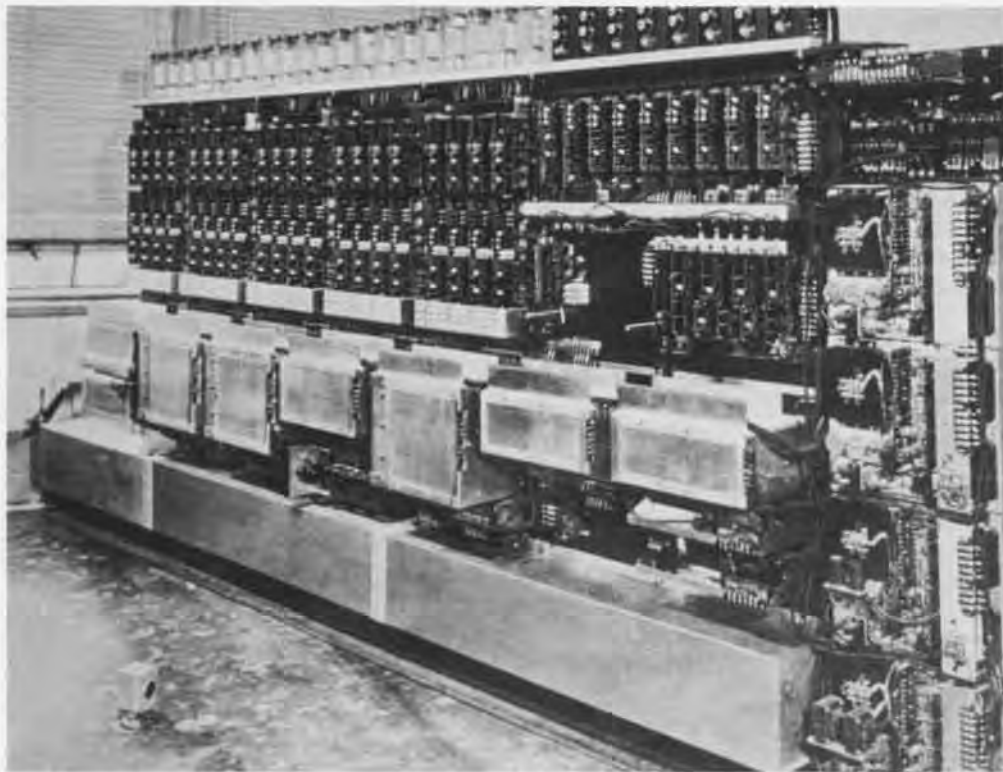

Figure 7. The monster circuitry and power supplies needed to drive the selectron memory at RCA. This machine is similar to the Johnniac built at Rand.

The idea of the core memory is very simple. A core is made of a material that has a square hysteresis loop. When magnetized by a current pulse, it will assume one or the other of its two magnetizations, and thereby "remembers" in which direction it was magnetized. This "memory" property is a free gift of nature. The main artifice that had to be devised was the magnetization of one core among many in an array in a desired direction, without disturbing the state of any other core. This is achieved by the coincidence of two currents, one along rows and the other along columns, whose combined effect magnetizes the core at the intersection. The currents are too weak to singly change the magnetization of a core as their magnetomotive force is below the "knee" of the hysteresis loop. Of course the critical need is for a material with a square loop. Actually, I had thought of the concept long before; in fact, I cannot remember when it was not evident to me. However I did not know of any material with a "square loop."

To my great amazement one day, I was reading a technical journal and I found that the Germans had developed a square loop material that was used in magnetic amplifiers for submarines. ARMCO Corporation in Philadelphia acquired the patent rights and were manufacturing the material, which consisted of a very thin ribbon of permalloy. This very delicate ribbon was "wrapped" around a ceramic bobbin. Each such bobbin could serve as an element of the core memory. MIT had

also discovered the ARMCO bobbins and we both used them in early experiments. They were about \$10 each, relatively bulky and delicate. It seemed evident that ferrites would be preferable. Ferrites are made of metal oxides, are insulators, produce no eddy currents, and were and are widely used for high frequency transformers and television yokes. In these applications, any hysteresis produces great losses and is carefully avoided. I approached experts on ferrites at RCA and asked them

whether the hysteresis they so carefully avoided could instead be greatly accentuated and I was very surprised that in less than six months they produced excellent square hysteresis materials. We immediately proceeded to model tiny cores from those materials. Incidentally MIT approached other material exper. and also obtained good materials at approximately the same time.

Figure 8. The principal of the core memory.

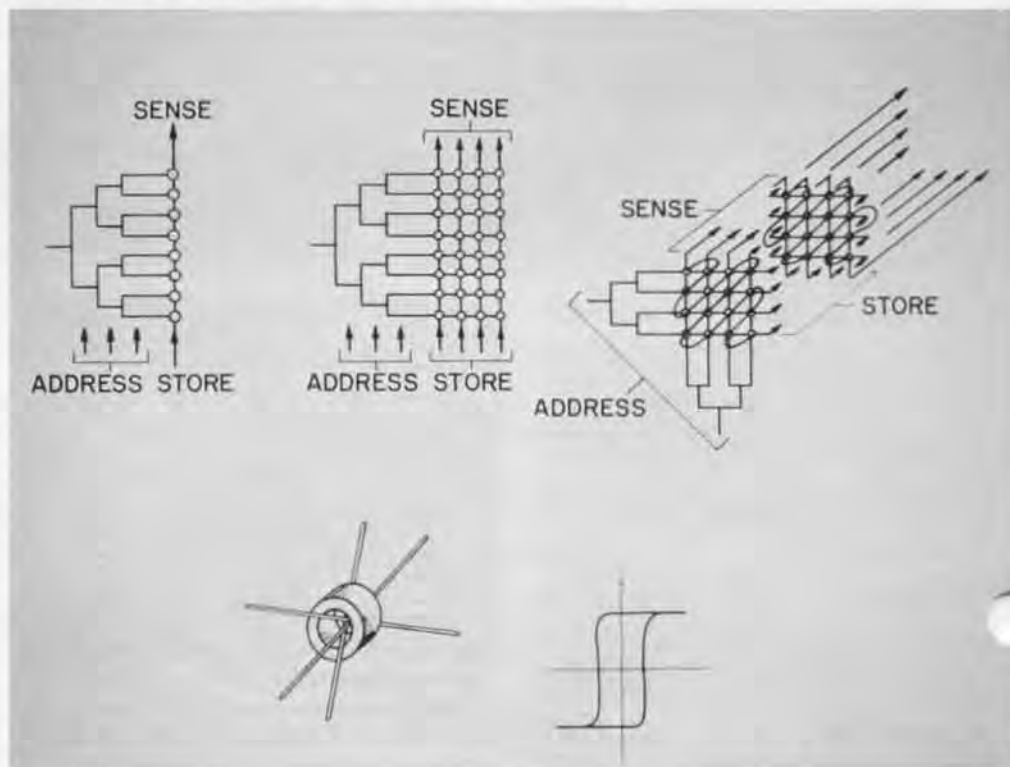

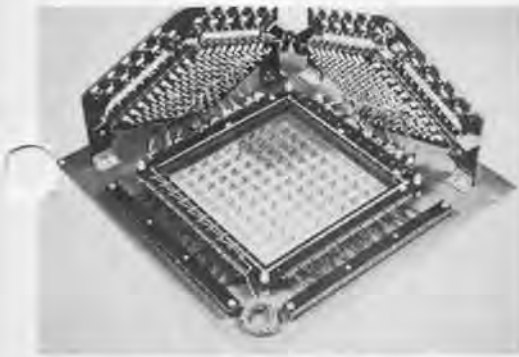

Figure 9. One of RCA's first core memories.

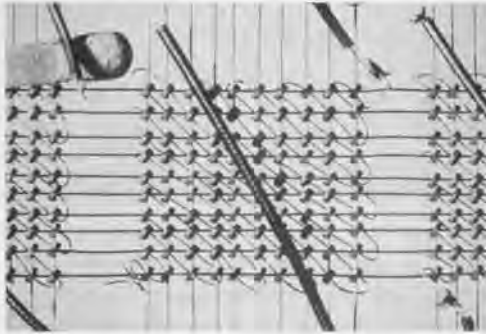

Figure 10. Detail of an early RCA memory. Note the use of decimal numbers, chosen because of the craze for decimal machines prevalent at the time.

As is well known, the core memory became the standard and was a key in the development of computers. It was surprising that the memory, which by its very operation requires many elements, should be made by discrete elements assembled into arrays. Why not an "integrated" fabrication of some sort whereby all magnetic elements and their linking conductors are made by some overall integrated technique that made the whole array at once. Thus, from the very beginning there was an issue of "integration" versus "automation" (as cores became gradually made by automated presses, were tested automatically and assembled semi-automatically). For example, RCA and Bell Labs made ferrite plates with an array of holes, each threaded by metalized coatings on the plates. Many groups worked on plated wires, which could be made by a continuous process. However, the cores continued to be made by improved methods and, by and large, provided better operation at lower cost, and thus prevailed against all other magnetic memory approaches. In a sense, automation won against integration.

All the efforts at integration were not lost, however. In experimenting with apertured ferrite plates, we invented the transfluxor, a core with two holes, i.e. a



Figure 11. Cores held on a strand of human hair.

relay with no moving parts. The transfluxor was used in some of the early satellites and for foolproof controls in the New York subway. Ironically, the Russians read our papers and used these devices in many industrial controls as they were very slow in developing transistors. Such magnetic logic circuits might be the basis of computers (in fact Univac had a design) if the transistor had not been invented.

A brief mention should be made of our early attempts at integration on a grand scale: planes with half a million bits. These utilized the cryotron, a superconductive switch invented by Dudley Buck at MIT, and made by thin film evaporation techniques. Interestingly enough, our main problems turned out not to be with the indispensable operation at liquid helium temperature, but rather with the problems of imperfections that seem inevitable with such large and dense arrays. It is these imperfection problems that plague present day large capacity chips, and that are being solved by sophisticated error correcting methods and extreme care in fabrication.

The modern development of integrated circuits is of course one of the present day wonders. Memory chips with a million or more bits are being manufactured at very low cost. The integrated circuit memory chips have given us a solution to the memory that is better by orders of magnitude than any previous technology. In fact, it is very difficult to imagine a better technology. The chip is a triumph of fabrication of geometries at the micron, and soon submicron, scale. Operation is obtained by deliberate geometrical shaping and deliberate synthesis of materials, and is all human artifact, not based on some fortuitous natural property, as that of the square hysteresis of some magnetic material.

In the early days, when any workable random access memory was a great achievement, von Neumann thought that a forty thousand bit capacity would be sufficient, provided there

was a sufficiently large serial mechanical memory to back it, i.e., tape, drums and later discs. I was always convinced that there is essentially no limit to the need for capacity in the random access memory, and thought that there was no fundamental need for a hierarchy of memories but merely a practical recognition that such hierarchies provide indispensable storage capacity. Today, large capacity chips provide enough memory so that some personal computer systems need nothing additional (HP). This trend will continue into larger computers, particularly when non-volatile techniques are further developed. In the meantime, greater capacity in random access memories are being sought for image storage and manipulation, as well as for many, if not most, tasks sought by artificial intelligence. I believe that semi-conductor technology will provide ever greater capacities for these uses. Though nature stores in DNA at densities orders of magnitude greater no reasonable proposal has yet been made to exploit such molecular storage for a random access memory or even for a memory that is accessed in some more sophisticated way, such as through the stored contents. Most inventions of men are imaginative intellectual constructs that more often try to defy nature rather than to imitate it.

Honeywell Animals Find a New Habitat

Six of the famous computer component animals built by Honeywell are on display at the Museum. These six of the more than 100 animals made were "rounded up" by Morris Dettman, who sponsored these sculptures for a Honeywell advertising campaign that ran from 1964 to 1978. Honeywell put together the display of the animals along with an introductory case with illustrations of the ad campaign.

Each animal sculpture was produced from the contemporary computer components of the time. Since about half a dozen sculptors from the Boston area were used, several different types were produced. For the most part, the animals are either sculpted from styrofoam or formed from wire mesh and then the components put on the surface to form an appropriate mosaic.

The Story of the Animals

The first sculpture was a fairly primitive, pterodactyl-looking bird escaping from a cage. The headline proclaimed, "You're free. Honeywell's 'Liberator' lets you switch to the H-200 without reprogramming."

The second sculpture was a racehorse. The headline was: "The Honeywell 200 is off and running."

The dragon on display at the Museum was used with the slogan, "Honeywell's new computers introduce a little magic to banking." Walking around the case, the visitor can see how the components are attached to the wire mesh frame.

After use within the ads, the popular animals were often given as awards to employees and customers. We have heard that the pride of lions lie in rest in Phoenix and a six-foot span eagle is in Washington, D.C. The Museum would

like to play Noah and at least compile a listing—one by one—of the locations of the animals with a guarantee that we would take any in and preserve them for posterity.



Mr. and Mrs. Morris Dettman with a fish—or half a fish. Not all animals were done in the round since the purpose was photography for ads. Morry said, "The \$1,500 to \$5,000 price tags on any of the animals was quite cheap when you think of fees for models' time, props and so forth."



This early bird sculpture got the Honeywell ad campaign off the ground in 1964.



Wanted: Animals for the Permanent Collection.

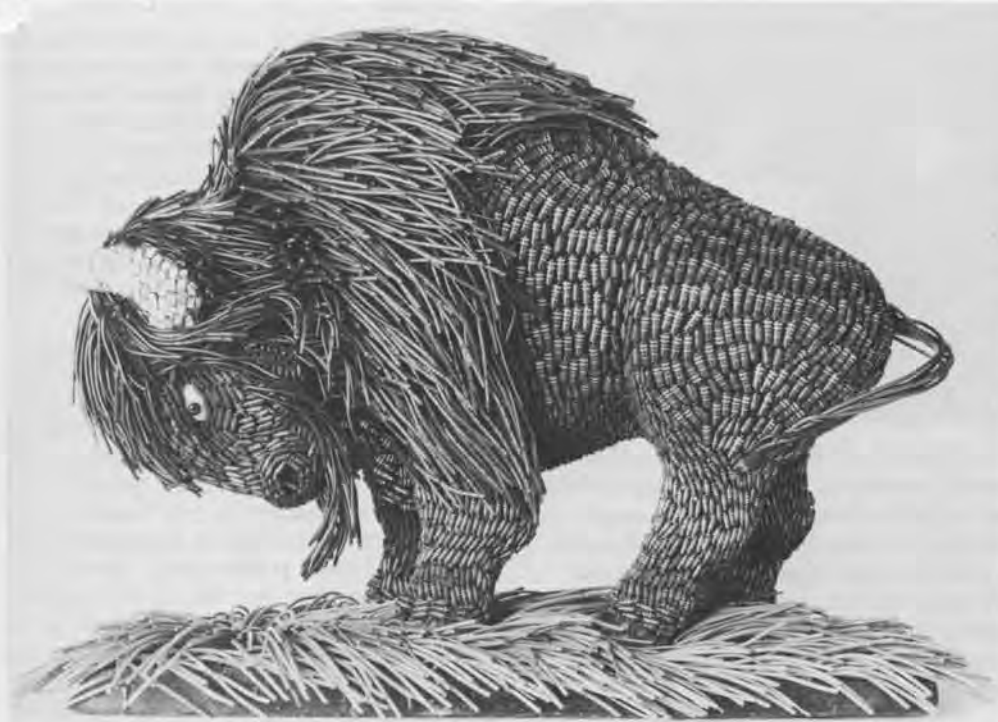

A Search for Lost Animals

The whereabouts of most of the one hundred animals, sculpted between 1964 and 1978 for one of the longest running ad campaigns, are unknown. If anyone knows the location of any of the other animals, the Museum would like to increase the flock for its collection, along with any of the other ephemeral material that was made to capitalize on their appeal. To date, the Museum has only a deck of cards and several posters, although calendars, small replicas and other items were made.

Honeywell's animals are an important part of the culture of computing and thus appropriate to be collected by the Museum. Anyone who saw the ads didn't forget them. The transistors, resistors, switches, cabling, diodes, and later integrated circuits from which they were made brought the "insides" of the computers to the forefront, demystifying and even making light of the magical equipment inside of the computer "black box."

Twenty-one years ago, Morris Dettman had the vision to create these animals and this year he saw to it that the display was made and loaned to the Museum for the enjoyment of the public.

The fox has a styrofoam base and can be identified as one of the later sculptures because of the use of integrated circuits for the legs.



Questions About the New Exhibits

A number of new interactive exhibits were completed and new artifacts placed on display for the May 3rd annual meeting of the Board of Directors and our benefit party.

If you couldn't make the benefit, "The Magical Mystery Tour," you can still visit the Museum and take the trivia quiz on our new exhibits and win a prize. When you complete the quiz, give it to one of the interpreters and you will be rewarded with one of the Museum's special treasures.

In the 1950-70 timeline, the tombstone epitaph stands for _____.

A tin automatic reference guide was made for _____.

The integrated circuit exhibit includes an evolving number of chips under the microscope. What are the colors of the IBM 64K chip? _____.

A number of additions have been made to the burial mound of single-user machines. The Honeywell Kitchen Komputer, an IMSAI, a Scelbi, and Apollo's first workstation with _____ disk drives.

In the Image Gallery, there is a bar-relief image of the _____, the S in typography has _____ lines of resolution, the teapot can be illuminated in _____ different ways, the fourth order fractal is colored _____, and, can the tree carry the girl over the house to the rabbit? _____ (yes or no).

Six Honeywell animals show off the components of the era from 1964 to 1978. The blue stripes on the fish are made of _____.



Trying to get the EXTRA question: What is the resistance of the largest component of the owl's ear? _____.



Paul Severino, President of Interlan, with David and Chris Potter, didn't have to trace the location of the ethernet cable, because Paul arranged the gift and Dave managed the installation. When you visit, look for the yellow cable that starts in the computer room on the first floor and runs throughout the Museum.



Danny Hillis, the builder of the tinker-toy tic-tac-toe computer, making a point to Mitch Kapor. He's probably explaining the answer to the question: Where is the tinkertoy logic thinnest in the tic-tac-toe computer? _____.

Exhibits of the Best

Computer Graphics Image Contest

The Grand Prize of The First Annual International Computer Graphics Image Contest sponsored by Raster Technologies, Inc., and The Computer Museum was awarded to Don Stredney and Jose Garabis of Cranston/Csuri Productions for their rendering of "Medical Poster." Eight other winners, five in the professional category, and three in the student category, will be on display at the Museum through January 1.

Oliver Strimpel, the Museum's curator who sat on the judging panel, was impressed with the quality and diversity of content in the 300 images that were received. "The entrants spanned a wide range of technique, from paint on a personal computer to ray tracing and procedural modelling on high resolution devices. I was particularly pleased to receive the first (known to the judges) ray-traced rendering of a caustic curve and we awarded this image second prize in the professional category."

Winners in the professional category were:

1st: "Movie Package" by Maria Palazzi, Cranston/Csuri Productions.

2nd: Untitled by Michael Sciulli, J. Arvo and Melissa White, Apollo Computer Inc.

3rd: "Wood Duck" by Russell Brown, Adobe Systems.

Honorable mentions: "Under construction" by Patrick McCormack, U.S. Air Force, Scott AFB; "Knoll" by David Kamins, Boston University Computer Graphics Laboratory.

Winners in the student category were:

1st: "Space Tubes" by Anne Seidman, William Kolomyjec and John Donkin, Ohio State University.

2nd: "Study of Expression, No. 6" by Andrew Pearce and Milan Novacek, University of Calgary.

3rd: Untitled, by Hillary Kapan, University of Oregon.

Original Artwork of BYTE Covers on Display Starting September 8

In honor of BYTE's tenth anniversary, the Museum will display a retrospective of Robert Tinney's original artwork for BYTE covers. Since 1975, Robert Tinney has created more than 80 BYTE covers—from spoofs on the industry, the user and computer design to illustrations of highly technical subjects.

The Museum Store will also carry limited editions of prints and T-shirts from these covers.

Fall 1985 Program Series

Sundays at 4 p.m.

September 8

Tony Hoare, Oxford University
The Mathematics of Programming
BYTE's Tenth Anniversary Lecture

September 15

Gardner Hendrie
From the First 16-bit Mini to Fault Tolerant Systems

September 22 1-4 p.m.

Stephen Ciarcia, BYTE Columnist
Ciarcia's Circuit Cellar Showcase

September 29

Walt Tetchner, DEC, and Dennis H. Klatt, MIT
DECTALK: History and Applications of a Talking Computer

October 6

Richard Greenblatt, Vice President, Lisp Machines Inc.
Artificial Intelligence at MIT: 1963-70

October 13

Alan Kay, Fellow, Apple Computer
Personal Computing before Micros

October 20

Siggraph Video Fest
The Best Computer Video of Siggraph 1985

October 27

Oliver Selfridge, GTE Corporation
Where do we want artificial intelligence to go?

November 3

Andries van Dam, Brown University
Computer Graphics: From Arcane Specialty to Anyone's Game

November 10

Otto Laske, Gregory Garrey, Peggy Brightman,
New England Computer Arts Association, Inc.
The Computer Arts in Perspective: Music, Graphics, Choreography.

November 17

Peter Rony, IEEE Computer Society and
Japan Micro-Mouse Association
Mappy, the Micro-mouse Inaugural Run of the Maze at the Museum

November 24

Tom Snyder, Tom Snyder Productions
Educational Software: A Satire of Itself?

Thursdays at 7 p.m.

October 10

Barry Vercoe, MIT Experimental Music Studio
The Computer as Chamber Music Performer

October 24

Trip Hawkins, President, Electronic Arts
The Rebirth of the Home Computer

November 7

Joel Moses, MIT Dept. of Electrical Engineering &
Computer Science
The Organization of Large Systems
The Carl Engleman Memorial Lecture on
Artificial Intelligence

November 21

Philip J. Davis, Brown University
Millions of Digits of Pi: What's Behind It All?

December 5

Nelson Max, Lawrence Livermore Laboratories
Computer Animation in Mathematics, Molecular Biology and Art

The Computer Museum

All programs will take place in The Computer Museum Auditorium. Admission to the programs is free for Computer Museum members, and free to others with admission to the Museum: \$4 for adults; \$3 for students and senior citizens. Reserved seats are available to members by sending \$2 per seat per program to Programs Coordinator, The Computer Museum, 300 Congress Street, Boston, MA 02210. Please make checks payable to The Computer Museum and clearly indicate which program(s) you plan to attend. Seats may also be reserved by paying \$2 at the door up to one half hour before the program begins.

Sponsored in part by grants from the Bank of Boston and Digital Equipment Corporation.

For more information call 423-6758.



Sunday, September 22, 11:00-6:00

ATTIC SALE

Get your hands on computer gadgetry, photos, graphics, books, manuals, and more at the Museum's "computer flea market"—a real hacker's dream.

Clean out your attic with contributions to the Museum's sale—fully tax deductible. One hacker's throwaways are another's key parts! Items may also be sold on consignment, and vendor tables are available for rent. For more information about participating in the ATTIC SALE, contact Jessica Pollard at The Computer Museum (617) 426-2800.

Saturday and Sunday, October 27 and 28, 11:00-6:00

"A LOOK AT THE FIRSTS"

As part of Museum Goers Month, we invite you "behind the scenes" to see some of the historic firsts in our stored collection. Meet *Shakey*, the first computer-controlled robot ever built, try out the first mechanical calculator, or play the world's first computer video game, *SpaceWars!*, running on the vintage PDP-1 computer. Some of the MIT hackers who created the *SpaceWars!* program in 1962 will be on hand to challenge those who dare. For nostalgia buffs we will power up the IBM 1401 and display the first digital computer—the ENIAC.

THE END BIT

0000000001

The first view of another planet from a vantage point in space taken on July 15, 1965 when the space probe Mariner 4 flew by only 6,118 miles from the surface of Mars.

After the failure of Mariner 3 (whose camera shroud had jammed), NASA project scientists at The Jet Propulsion Laboratory anxiously awaited the signals from Mariner 4's cameras during the final approach to Mars. A picture was transmitted to Earth as a stream of eight bit numbers, each of which was coded for the brightness of a point in the picture. They were arranged column by column, starting at the top left hand corner. When the data started to come in—at a rate of one eight bit number a second—the project scientists, eager to see the first closeup of the Martian surface, took turns to hand color-code the strips of data hot off the printer. Bob Nathan, one of the scientists, recalls that after approximately four hours about half the picture (100 columns) was in place, someone pointed to the wavy line near the bottom of the picture exclaiming "hey—could that be Mars?"

The information on the picture is minimal, owing to the uneven response of the Mariner's TV camera and the fact that the edge of Mars was cloud-covered.

On loan from NASA, Jet Propulsion Laboratory, Pasadena, California.

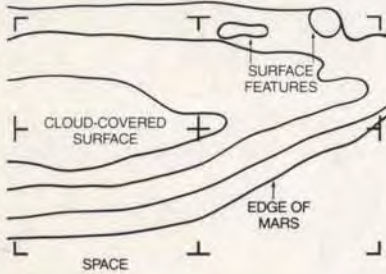
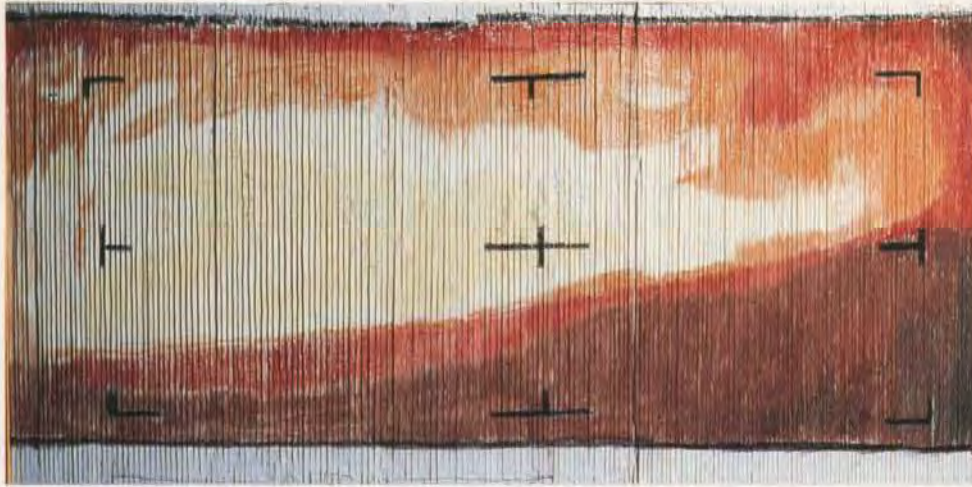

Address Correction Requested

Non-Profit
Organization
U.S. Postage
PAID
Permit No. 110
Fitchburg, MA
01420

The Computer Museum 300 Congress Street, Boston, Massachusetts 02210

THE COMPUTER MUSEUM HISTORY CENTER



1 026 2147 6

THE COMPUTER MUSEUM REPORT

VOLUME 14

FALL/WINTER 1985

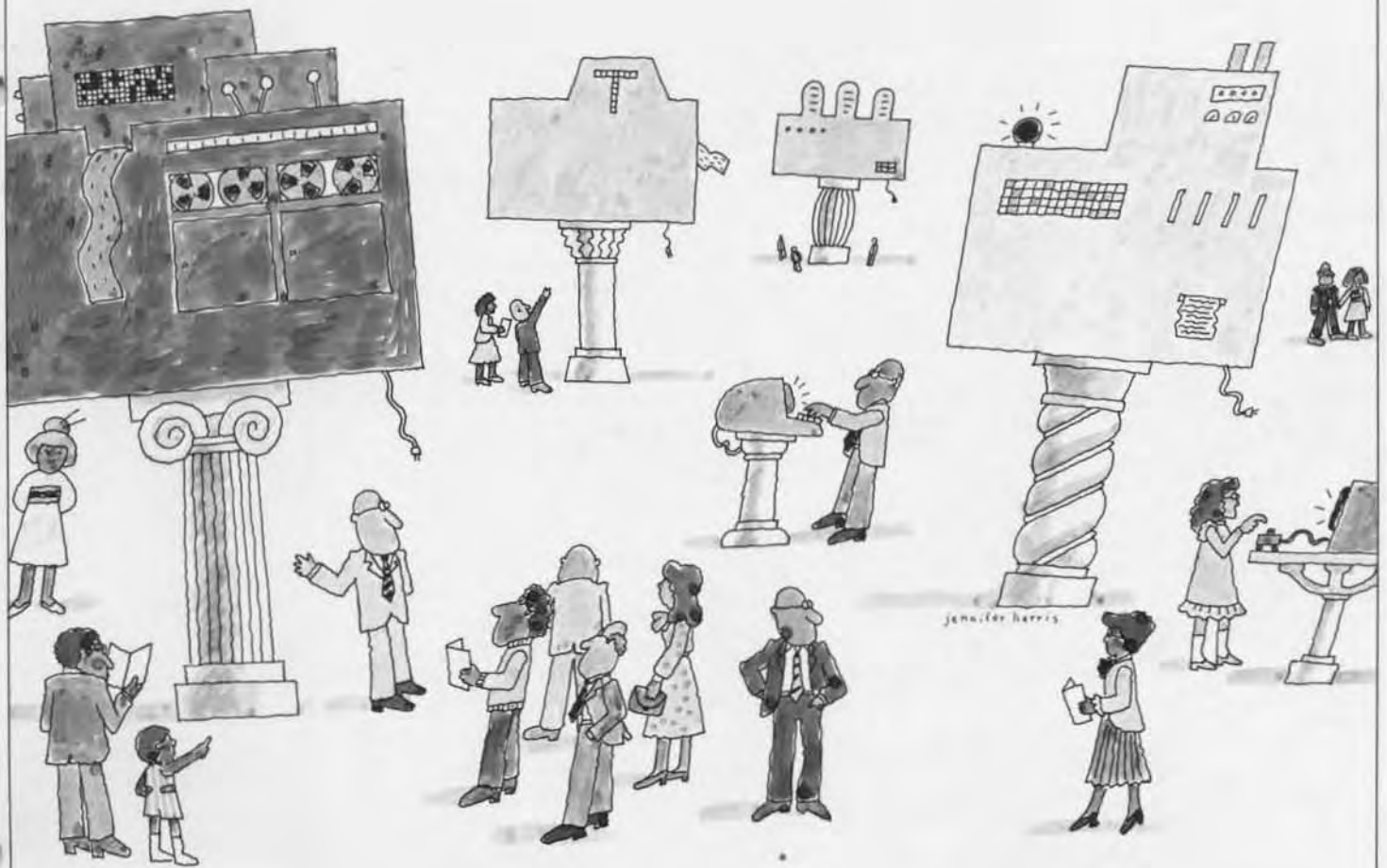

Board of Directors

John William Poduska, Sr.,
Chairman
Apollo Computer Corporation
Gwen Bell, President
The Computer Museum
Erich Bloch
National Science Foundation
David Donaldson
Ropes and Gray
Sydney Fembach
Computer Consultant
C. Lester Hogan
Fairchild Camera and Instrument
Corporation
Sir Arthur Humphreys
ICL
Theodore G. Johnson
Mitchell Kapor
Lotus Development Corporation
August Klein
Masscomp
Dr. Koji Kobayashi
NEC Corporation
John Lacey
Control Data Corporation
Robert Lucky
AT&T Bell Laboratories
Patrick McGovern
CW Communications Inc.
James L. McKenney
Harvard Business School
Carver Mead
California Institute of Technology
William Millard
Computerland Corporation
Arthur P. Molella
The National Museum of
American History,
Smithsonian Institution
Brian Randell
University of Newcastle upon Tyne
Jonathan Rotenberg
The Boston Computer Society
Jean E. Sammet
International Business Machines
Edward A. Schwartz
Digital Equipment Corporation
An Wang
Wang Laboratories, Inc.
Maurice Wilkes
Digital Equipment Corporation

Trustees

Charles Bachman, C. Gordon Bell,
Harvey D. Cragon, Robert Everett,
Andrew Knowles, George Michael,
Robert Noyce, Kenneth Olsen,
Kitty Selfridge, Michael Spock,
Erwin Tomash, Paul Tsongas

Executive Committee

David Donaldson, *Chairman*, Gwen
Bell, Theodore Johnson, August Klein,
Nicholas Pettinella, Jonathan
Rotenberg, Ronald Smart, Oliver
Strimpel, Michael Templeton

Corporate Members

Benefactor—\$10,000 or more
American Express Foundation
American Federation of Information
Processing Societies
American Telephone & Telegraph Co.*
Apollo Computer, Inc.*
Bank of America*
Bank of Boston
The Boston Globe*
ComputerLand*
Control Data Corporation*
Data General Corporation*
Digital Equipment Corporation*
Hewlett-Packard
Honeywell Information Systems
International Data Group*
International Business Machines, Inc.
NEC Corporation*
The MITRE Corporation*
The Travelers Companies
Wang Laboratories, Inc.*

Patron—\$3,000

Adage, Inc.
Addison-Wesley
Bitstream
Boris Color Lab, Inc.*
Burroughs Corporation
Coopers & Lybrand
Datapoint Corporation
DECUS*
Draper Laboratories*
Gaston Snow & Ely Bartlett*
General Computer Co.
The Honeywell Foundation
Index Systems*
Intel Corporation
Arthur D. Little, Inc.
Major Computer, Inc.
MASSCOMP
McGraw-Hill, Inc.
Regis McKenna, Inc.*
Ropes & Gray
Microsource Financial
United Technology Mostek
Nolan, Norton & Company, Inc.*
Prime Computer Corporation
The Prudential Insurance Company
SHARE, Inc.
Software Results Corporation*
Stratus Computer, Inc.*
Symbolics, Inc.
3Com Corporation*
/u/s/rl group
Venture Founders Corporation

Contributor—\$1,000

Analog Devices, Inc.
American Management Systems*
Arthur Andersen, Inc.
Autographix
Bolt Beranek & Newman
Citicorp (USA), Inc.
Cullinet Software, Inc.
Dane, Falb, Stone & Co.
E.J. DuPont DeNemours & Co.
Foley Hoag & Elliot
Ford Motor Company*
General Systems Group, Inc.*
Germain Lawrence DRK
Gould, Inc.
Greylock
GTE Data Service, Inc.
GTE Laboratories, Inc.
Houghton Mifflin Company*
Hyams Trust
International Computer Ltd.*
Investment Orange Nassau, Inc.
LTX Corporation
Manufacturers Hanover Trust
Meditech*
Mentor Graphics
MICOM-Interlan, Inc.
Micro Control Systems
Microsoft*
New York Air*
PC Magazine
Peat, Marwick & Mitchell
Pell, Rudman, Inc.
Pencept, Inc.
Polese-Clancy, Inc.
Standard Oil Corporation
Teradyne
XRE Corporation
ZBR Publications, Inc.

*Also contributed to the
Capital Campaign

Core Members

Harlan E. and Lois Anderson
Charles and Constance Bachman
C. Gordon Bell
Erich and Renee Bloch
Henry Burkhardt III
R. Steve Cheheyil
Robert C. and Eleanor W. Chinn
Robert G. Claussen
William Congleton
Alex d'Arbeloff
Arnaud de Vitry
David Donaldson
Douglas Drane
Robert Everett
Kenneth G. Fisher
Jay W. Forrester
Gardner Hendrie
Winston R. Hindle, Jr.
Peter Hirschberg
Theodore G. and Ruth T. Johnson
John Allen Jones
Mitchell Kapor
Allan Kent
Jack S. Kilby
August Klein
Andrew C. Knowles, III
David J. A. Koogler
Edward and Debbie Kramer
John W. and Edna W. Lacey
Ralph and Linda Linsalata
John Norris Maguire
Richard D. Mailery
Thomas Marill
Daniel D. McCracken
James L. McKenney
Thomas and Elizabeth McWilliams
Carver Mead
Robert M. Metcalfe
Robert M. Morrill
David and Pat Nelson
Robert Noyce
Kenneth Olsen
Stanley C. Olsen
John L. Payne
Edward G. Perkins
John William Poduska
Robert M. Price
Fontaine K. Richardson
Douglas Ross
Jean E. Sammet
Paul and Catherine Severino
Alan F. Shugart
Richard L. Sites
Ronald G. Smart
Charles E. Sporcck
Ivan and Maria Sutherland
Del Thorndike and Steve Teicher
Erwin Tomash
Jean De Valpine
Charles P. Waite
Stephen L. Watson
Harvey W. Wiggins, Jr.
William Wolfson

Contributing Members

Kenneth R. Adcock, J.D. Addeleston,
Lawrence Adrian, Timothy Anderson,
Isaac Auerbach, Richard G. Bahr, John
Banning, Art & Betty Bardige, Steve F.
Barneby, John C. Barstow, G.C. Beldon,
Jr., James Bell, Alfred M. Bertocchi, Dr.
John H. Blankenship, Daniel S. Brick,
Philip D. Brooke, Fred and Nancy
Brooks, D.F. Brown, Gordon S. Brown,
Lawrence G. Brown, Roger M. Buoy,
James Burley, James Burnett, Maria L.
Carr, Charles and Virginia Casale,
George Chamberlain, Donald
Christiansen, Richard J. Clayton,
James F. Cody, Richard Corben, Howard
E. Cox, Jr., Michael Cronin, Henry J.
Crouse, Daniel Crowley, David N.
Cutler, Nick De Wolf, Peter De Wolf,
Quentin De Wolf, James B. Deaderick,
Lucien and Catherine Dimino, Mr.
Ditargiani, Philip H. Dorn, Theodora
Drapos, Ray Duncan, Joseph J. Eachus,
Fred Ebeling, Dr. Richard Eckhouse,
Tom Eggers, Dan L. Eisner, Lucian
Endicott, Bob O. Evans, Robert A.
Farmer, Andrew D. Feit, Read T.
Fleming, J. Thomas Franklin, Clark
Frazier, Alan E. Frisbie, Edward A.
Feustal, Lorrin Gale, Kevin A. Galvin,
Branko J. Gerovac, David Goodman,
William Graustein, John Griffith,
Stephen Gross, Dr. Roberto Guatelli,
Jerrie A. Haddad, Michael P. Halter,
William R. Hambrecht, J. Scott
Hamilton, Sheryl Handler, Walter and
Catherine Hawkins, Frank E. Heart,
William Helm, Jr., Robert and Carol
Henderson, Margaret Herrick, Robert B.
Hoffman, Thomas L. Hohmann,
Nancy S. Horie, M. Ernest Huber, Bill
Hunzeker, Michael Jerabek, Charles A.
Jortberg, Richard M. Karoff, Lawrence
J. Kilgallen, Martin Kirkpatrick, Bryan
S. Kocher, Alan Kotok, Stanley Kugell,
Theodore Kuklinski, Raymond
Kurzweil, Robert Laman, Glen C.
Langdon, Jr., Andrew Lavien, John R.
Levine, Michael Levitt, John V. Levy,
Steven B. Lipner, Carl D. Lowenstein,
John Lowry, Arthur Luehrmann, Carl
Machover, Julius L. Marcus, Andrew F.
Mason, Joe W. Matthews, Robert
Mayer, Jr., Richard McCluskey, Tron
McConnell, F. Warren McFarlan, Jim
McIntosh, Robert W. McKnight, Todd
Medlock, R. W. Meister, Bernard G.
Mills, Charles Minter, Allen Moulton,
Dr. J. Craig Mudge, Carol E. Muratore,
Dr. and Mrs. Isaac R. Nassi, Cynthia L.
Nelson, Stewart Nelson, Joseph Nestor,
Joseph M. Newcomer, Chuck Newman,
Tim K. Nguyen, Bernard J. Nordmann,
James N. O'Boyle, Jr., Anthony G.
Oettinger, Lawrence & Pauline Oliva,
John E. Parker, Kenneth D. Patterson,
James and Martha Patton, Nicholas and
Nancy Pettinella, James H. Philip,
Linda J. Phillips, Paul R. Pierce, Juan A.
Pineda, James A. Pitts, Andrew Plescia,
J. Eric Pollack, James N. Porter, Robert
C. Probasco, C. Mike Riggle, David
Rodgers, Ann and Robert Roe-Hafer,
David C. Roh, Peter R. Rony, David
Rose, Paul Rosenbaum, Jonathan
Rotenberg, Martin S. Roth, Thomas S.
Roy, II, Eugene Rudolphe, Michael J.
Samek, Peter L. Samson, F. Grant
Saviers, Edward A. Schwartz, Andrew
Scott, Oliver and Kitty Selfridge, W. Lee
Shevel, John J. Shields, III, Diane J.
Skiba, Ph.D., Allen G. Sneider, Stuart
Solomon, John R. Spencer, John Stark,
Max J. Steinmann, William M. Steul,
J. Michael Storie, Charles A. Stott,
David Tarabar, John V. Terrey, William
R. Thompson, Warren G. Tisdale,
Michael G. Tomasic, Sherry Turkle, G.
Michael Uhler, Noah E. VanDenburgh,
Thomas Vaughn, Christian Walker,
Allan L. Wallack, Joseph B. Walters, Jr.,
Thomas E. Welmers, John D. Wick,
Hugh M. Wilkinson, III, Kevin
Willoughby, Andrew Wilson, Richard T.
Witek, T.J. Wojcik, Jr., D.L. Wyse, Jeffery
N. Zack

Contents

1

The President's Letter
Dr. Gwen Bell

3

The Evolution of "C&C"
Japanese Aspect
Dr. Koji Kobayashi

7

The Collection

16

Blue Room Blues

The President's Letter

"Museums in the modern world exist, we are told, to fulfill a fourfold function: to collect, conserve, exhibit and elucidate. There is rarely any mention of the balance between them, and the stress is always on the first, irrespective of whether the other three can be fulfilled in terms of resources. Collect or die. . . . What we should be doing instead is assessing our collections, refining some (dare I mention disposal, embodied in that emotive word 'de-accessioning?'), closing others, and, even more important, putting what we have got into good order."

Sir Roy Strong
Director, Victoria & Albert Museum
The Listener 25 July 1985

Collecting was the original goal of the Museum, and is our *sine qua non*. But as our collections increase, selection, conservation, and elucidation become more and more important. This issue of the *Report* lists the artifacts acquired in the last year and provides a time to assess our holdings.

The table on page 2 enumerates the Museum's computer-era artifact and film collections characterized by the levels of integration from the manufacturing base through applications and even including ephemera. The heart of the collection is in the middle: computer subassemblies and computers themselves. Subassemblies are the largest single collection of artifacts because they include transducer systems, secondary memories, and other major components. The 106 computers are all different, second or third copies of the same machine are not counted here. Why not stop here? Components are often the only remnants of early machines or are sufficient to show a given technology, such as the Atlas "toothbrush memory" or the Intel 4004 microprocessor. Since the goal of the museum is to document all aspects of computer technology, which includes manufacture. The process of how things are made are best recorded on film, hence this becomes a critical form of collecting.

Software, applications, and ephemera overlay the hardware technology levels. The way that software artifacts are counted here is highly misleading: the three items are all historical artifacts, such as Bill Gates' original paper tape of the BASIC assembler for the Altair. Operating systems and software in use have not been entered into "the collection." On their retirement from active use, a judgment will be made as to whether they should be placed in the permanent collections. The largest collection of software that we have is in the form of written documentation, such as the original handwritten Brooker Morris Compiler-compiler. Much of the paper documentation has been accepted, categorized by the box-load and set aside. However, we are sufficiently familiar with the material to find the sets of cartons that researchers need; we have recently supplied lawyers with documents required for several different cases of litigation. The material has not been properly sorted or cataloged and this is on the Museum's agenda. Our collection of applications also appears small, because these are often in the form of documents. The development of the Image Gallery led to the rapid expansion of materials that use computer graphics. Examples include early computer-generated pictures, film and objects designed or manufactured using computers.

Ephemera are intriguing and can be especially important to museums. Old buttons, t-shirts, coffee cups, posters, promotional material, video-tape spoofs, commercials and other objects recreate the spirit of the past as well as the technology. Professor Brian Randell, Chairman of the Museum's Exhibits and Collections Committee, recently wrote to us saying, "I can't stress the importance of collecting ephemera enough. When I was preparing a lecture on computing in the sixties, the advertisements triggered more memories about the era than did the technical articles." Without ephemera the 1950-69 timeline case would be less lively, and the IBM 1401 room would not have any semblance to reality. If anyone has a button

The Computer Museum

The Computer Museum is a non-profit 501(c)3 foundation that chronicles the evolution of information processing through exhibitions, archives, publications, research and programs.

Museum Hours: The Museum hours are 10 AM-6 PM, Tuesday, Wednesday, Saturday, and Sunday and 10 AM-9 PM, Thursday and Friday. It is closed Mondays, Christmas, New Years, and Thanksgiving.

Membership: All members receive a membership card, free subscription to The Computer Museum Report, a 10% discount on merchandise from The Computer Museum Store, free admission and invitations to Museum previews. For more information, contact Membership Coordinator at The Computer Museum, 300 Congress Street, Boston, MA 02210, (617) 426-2800.

Staff

Dr. Gwen Bell, President

Michael Templeton, Executive Director

Dr. Oliver Strimpel, Associate Director and Curator
Robert Carr, Manager of Interpretive Program
Russell Landers, Floor Manager; Kurt Levitan, Exhibit Operations Manager; William Wisheart, Registrar

Mark Hunt, Marketing Director
Louise Domenitz, Public Relations Manager
Jessica Pollard, Communications Assistant
Kathleen Keough, Functions Coordinator

Michael Oleksiw, Development Director
Anne Jenckes, Development Assistant
Scott Reilly, Membership Assistant
Linda Clingan, Museum Benefits Coordinator

Eva Radding, Business Manager
Lee Cohen, Store Manager; Steve Klinke, Assistant Store Manager; Nancy Dettero, Office Manager; Deborah Goudrecault, Business Office Assistant

THE COMPUTER COLLECTIONS

(calculators, card equipment and other pre-computing devices are omitted)

	Number of Artifacts	Films
Ephemera	10	3
Applications	22	105
Software (historical)	3	22
Computers	106	64
Sub-assemblies	329	20
Components	85	1
Manufacturing	16	7

collection (and some one out there must have one), we would love to have the ".... . Memorial Collection of Computer Buttons," or any other special collection or individual items.

This year, the Museum is undertaking a special search for artifacts relating to the history of personal computers. Computerland's President Bill Millard clearly saw that the Museum needed a more comprehensive collection of early personal computers and the materials that went with them in order to create a better exhibit. He convinced Pat McGovern of Computer-World to run a series of advertisements publicising our collecting effort and encouraging donations of early personal computing artifacts. As an extra inducement, donors of the "best" finds will be brought to the Museum for the grand opening party of the new personal computer exhibit. The Curator, Oliver Strimpel will be accepting nominees for acquisition until April 1, 1986. Judging will be based on when and where the machine or software was developed, completeness of the artifact, uniqueness, and importance to the history of personal computing.

In this way, the Museum hopes to add many objects to the permanent collection to provide primary source material for history. Even though the book shelves are beginning to groan under the weight of published accounts of personal computing, none begin to be comprehensive, and many are inaccurate. I recently talked to an author who was trying to describe the early days of using the model 33 teletypes with their paper tape readers. He described them as being "kludges" because he had heard they didn't work very well. I asked, "Have you ever seen one working?" He had not even seen one working or not—or talked to anyone who had used one.

The Museum is also trying to establish an international collection and an international view of the history of computing. The article by Dr. Koji Kobayashi of NEC describes his personal involvement in computing in Japan and their early machines. He is regretful when he remembers that the NEAC 2201, NEC's first transistorized computer was junked! And we are both pleased that he is sending the NEAC 2203, a 1958 machine, to The Computer Museum.

This issue of the Report is made possible by all of the people who have donated all of these artifacts to the collection. We all wish to thank them for entrusting their "memories" to us.

Gwen Bell



P.S. I wanted to update everyone on the museum's 1985 Attic Sale. On September 22nd, a number of companies, individuals, and volunteers joined museum staff in an old-fashioned attic sale of surplus and donated items, museum store merchandise, and retired photomurals from old exhibits that generated more than \$2000 to support the museum. Collecting museums approach attic sales the way porcupines make love—very gingerly—to be sure that no one confuses a museum selling donations or duplicate items unsuited for its collections with deaccessioning—the formal process of separating a collected artifact from a museum collection. In our case, the Attic Sale has benefitted donors, buyers, and the museum itself. We're planning to do it again next year, and are looking for both volunteers to make it a great event and for donations for resale. Just give me a call.

The Evolution of "C & C" A Japanese Aspect

The United States and Japan have both been involved in the progress of telephony and computing from the very beginning. Now, the advances are spreading throughout the world and can lead to a new era in mutual understanding.

Dr. Koji Kobayashi

In 1876, two Japanese students, Shuji Izawa and Kentaro Kaneko, participated in Bell's experiments with early telephony. Japanese was the second language to be spoken over the telephone set. The very next year, Japan imported two telephone sets that served as a trigger for the establishment of the Ministry of Communications in 1885, and subsequently the nationwide telephone system.

Twenty-three years later in 1899, EC Corporation was incorporated as a joint venture with what was then the Western Electric Company to implement this telephone system. NEC started by manufacturing telephone sets and switchboards. One of the epoch-making events in the communi-

cations technology in the 1930's was the development of the non-loaded cable carrier transmission system. The 1,900 mile system between Japan and China, completed in 1939, was produced entirely with Japanese technology, components and materials. I consider this to have served as the basis of establishing Japan's telecommunications technology.

With the advent of electronics technology, based on the invention of the transistor at AT&T Bell Laboratories, NEC proceeded to manufacture transistors and enter the computer field. In 1959 NEC exhibited the NEAC 2201 computer at the AUTOMATH in Paris. This was one of the first transistorized commercial computers to be

publicly operated.

In November 1964 when I became President of NEC, half of NEC's total sales were accounted for by Nippon Telegraph and Telephone (NTT), a semi-public corporation, and other government agencies. Although NTT had several 5 year plans for domestic communications networks, I thought that NEC should not rely only on the demand for domestic communications equipment, but that the company should expand and develop new business. Therefore, NEC went into overseas market. In 1964 total sales were 270 million dollars. In 1984 sales grew 30 times in 20 years to 8 billion dollars. Today, NEC's overseas business amounts to 3 billion dollars or 35% of total sales.

NEC has had business dealings with 144 countries, operating 20 manufacturing companies in 13 countries, 23 plants in 13 countries, and 23 sales and service companies in 13 countries. NEC employs 90,000 people, 11,000 outside Japan.

1930's: Desire to Develop Original Technology When I joined NEC in 1929, 90% of the telecommunications patents were owned by foreign countries. Japan's material and component industry was very small with most of the important materials imported from abroad. Young engineers including myself tried hard to find ways to change this. From 1930 a trend emerged that a nation's telecommunications infrastructure should not rely on imported technologies, and that equipment should be supplied based on domestic requirements and proprietary technologies. Thus, developing technology became a goal of Japanese engineers.

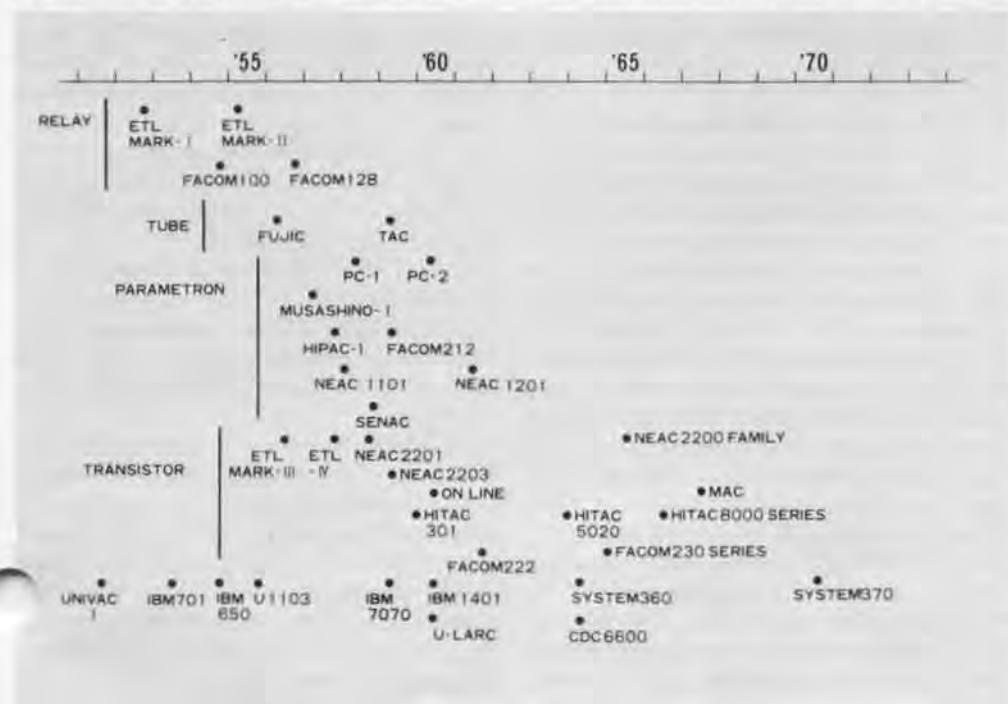

Roots of Japanese Computers

At that time, Dr. Shigeyoshi Matsumae and Dr. Noboru Shinohara of the Ministry of Communications proposed the first non-loaded cable carrier transmission system in the world. I was selected to participate in this development project to lay 1,900 miles of cable circuits between Japan and China. In 1939, after 7 years of work, the project was completed based on the original technology of Japan. I learned that to accomplish a project, whether it may take 10 years or 20 years, if the team settles down to work and uses their own abilities without relying on a quick fix of borrowing things, the road will open up in due course.

The Forerunner of Japan's Computer Development It is said that Japan's computer industry started about 10 years behind the United States. In 1946 when the world's first electronic calculator, ENIAC, was unveiled at the University of Pennsylvania, Japan was in a period of turmoil. After the conclusion of the peace treaty in 1952, communications led to the reinvigoration of technology. The development of radar during the war brought progress in pulse technology, and led to the development of digital multiplex systems using pulse-time and pulse-code modulation. Later, this digital technology came to form the basis of computer development. FM radio and television broadcasting began and consumer markets were born. The new word "electronics" presaged the birth of new industries. As research and development intensified, computers and semiconductors came to be considered major products for the future.

Japanese Computers In 1951, a computer project started under the leadership of Professor Hideo Yamashita of Tokyo University with the cooperation of Toshiba Corporation. This was called TAC, Tokyo University Automatic Computer, and is a Japanese vacuum tube computer. After much effort, the 7,000 vacuum tube machine was completed in 1959.

In 1949, Mr. Bunji Okazaki of Fuji Photo Film Co. began the development of FUJIC. Working almost alone, he completed it in 1956. This computer, used for the design of camera lenses, was the very first machine ever manufactured and put into practical use in Japan. It is exhibited at the Science

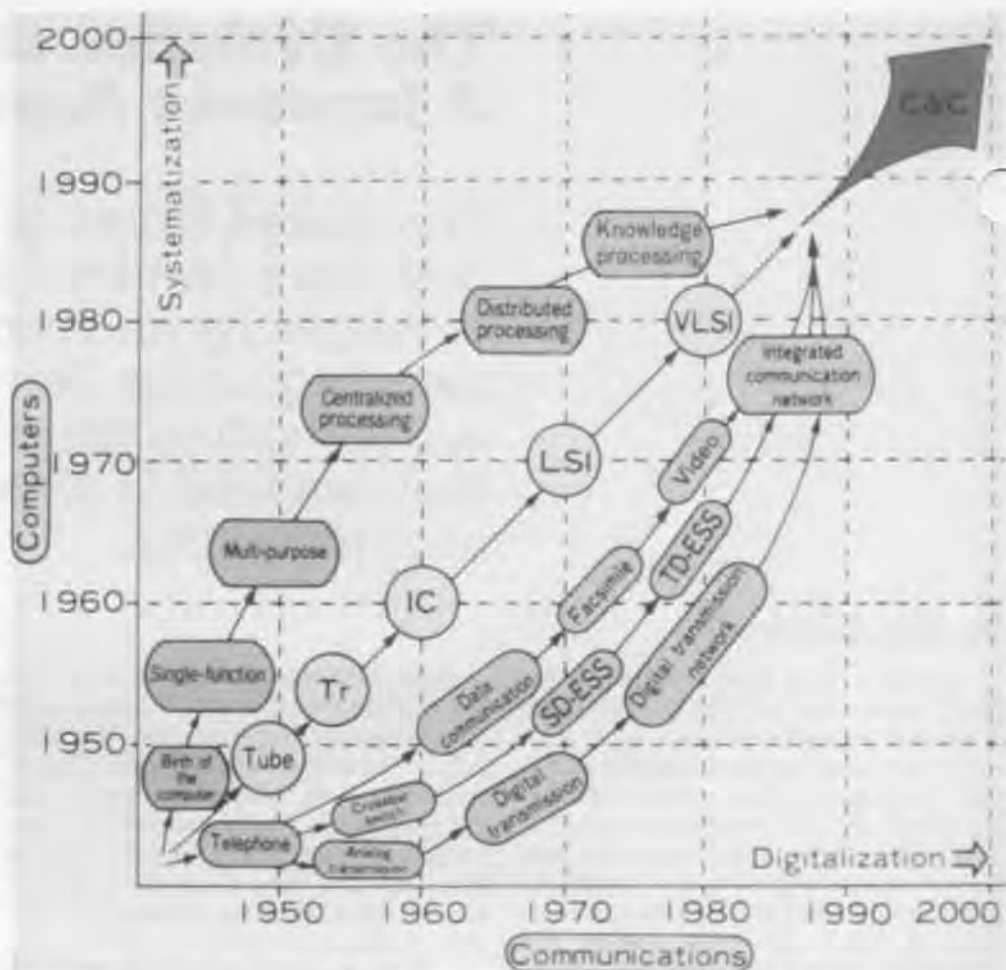

Museum at Ueno in Tokyo. Mr. Okazaki later moved to NEC and participated in the development of computers.

Before FUJIC was developed, relay type mechanical calculators were studied by the Electro-Technical Laboratory of the Ministry of International Trade and Industry. The resulting ETL Mark I was completed in 1952, and the ETL Mark II, in 1955. The logic formulas adopted for the circuit designs for the ETL Mark I were based on the 1935 Nakashima-Hanzawa theory of switching systems. This research was similar to the 1938 theory of Dr. C. E. Shannon of Bell Telephone Laboratories which attracted worldwide attention in the scientific community. The Japanese theory, however, was not announced overseas.

The invention of the transistor in 1948 by Bell Laboratories was a big shock to us. However, NEC succeeded in the trial manufacture of point contact type transistors in 1953 and then the development of various semiconductor products progressed rapidly.

In 1954 the parametron was invented by Dr. Eiichi Goto of Tokyo University. The parametron, a kind of solid circuit, was remarkably stable compared to conventional vacuum tubes and was far less expensive than transistors, which were expensive at

that time. Because of these merits, the possibility of using this new element was eagerly discussed because it was an original invention from Japan.

The leading developers of the parametron were the faculty of Tokyo University, engineers at the Electrical Communication Laboratory of Nippon Telegraph and Telephone, and Kokusai Denshin Denwa Co., Japan's international telecommunications carrier. Under the guidance of Professor Hidetoshi Takahashi at Tokyo University, the PC-1 computer using parametrons was developed in 1958 and the PC-2 in 1960. At NTT Laboratory the MUSA-SHINO-1 started operation in 1957.

The late Professor Kenzo Jo of Osaka University was another computer pioneer. Under his guidance, research on an ENIAC type model was started in 1947 and completed in 1952.

Computer Development at NEC In the field of communications the parts which limited the performance of multiplex carrier transmission equipment were filters. The design of these filters was extremely difficult, and the method used was direct experimentation. In 1955 Dr. Hitoshi Watanabe conceived of a new filter design theory that required calculations beyond the capacity of existing computers. As a

As a result, NEC decided to build a computer using the newly invented parametrons. In 1955, research and development was started on the NEAC-1101 followed by prototype manufacture in 1958. This first computer was used not only for the design of filters but also for the development of new technology and products. Figure 1 shows boards that are on display at The Computer Museum. Based on this technology, NEC developed the SENAC-1 jointly with Tohoku University, and named it the NEAC-1102. Later, NEC delivered the NEAC-1103 to the Defense Agency Research Laboratory.

With the success of the NEAC-1101, I determined that NEC would develop computers as a new business. This led to the introduction of small-size computers for business use, called the NEAC-1200 series.

Transistor Computers In 1954, Dr. Hiroshi Wada, director of the electronics department of the Electro-Technical Laboratory of the Ministry of International Trade and Industry, began developing computers using transistors. The ETL Mark III using point-contact transistors was completed in 1956, followed in 1957 by ETL Mark IV using junction-type transistors.

When I saw the ETL Mark IV, I immediately decided to commercialize it at NEC and introduced this computer one year later in 1958, thanks to energetic efforts of the company's engineers. This computer, the NEAC-2201, was exhibited at the Paris AUTOMATH in June 1959. Soon after that, the IBM 1401 was put on the market, and the age of the second generation of computers, which used transistors, began.

Computer Systems NEC further improved the NEAC-2201 by adding additional memory and input and output equipment to create an "electronic data processing system," the NEAC-2203. Programming efforts were greatly reduced by the early development of a compiler, named NARC. NEC proceeded with the development of complicated numerical calculation routines, such as programs for solving transportation problems, optimum path calculations, and linear programming. Through these experiences I came to fully realize the vital importance of software.

Japan's first on-line real-time seat

reservation system, based on NEAC-2203 technology, was put into use at the Kinki Nippon Railways in 1960.

In 1967, NEC developed Japan's first time-sharing system using a large-scale NEAC-2200 model 500 as the main computer. This was the end result of a long process starting with the NEAC-2202, which could be shared by 7 terminals based on the time division principle. Understanding the value of timesharing, NEC followed MIT's project MAC closely and used it as a model. NEC also called it the MAC system. With the first delivery to Osaka University, NEC's computer business evolved from small-scale, to medium-scale, then to large-scale, and from off-line to on-line systems.

Japan's Computer Development

Three unique features have channeled the direction of computer development in Japan.

First, Japan's commercial computer industry started with transistor machines jumping over the first generation of vacuum tube-based computers.

Second, Japan's computer industry grew from communications technology utilizing technology, components, and elements which were developed for communications equipment. Thus communications and computers have developed a technologically close relationship in such things as circuit designs, analog to digital conversion, and adoption of solid-state circuitry.

In contrast, most American and European computer manufacturers began as office equipment makers supplying such products as punch-card systems. In their development processes, they converted their machines to electronic systems, and became computer producers.

Third, the Japanese government exerted helpful efforts during the formative period of the electronics industry, promoting telecommunications, consumer electronics, computers, and semiconductor products.

Through the first half of the 1960's, single purpose machines were classified into scientific use and office use. Then the trend shifted to multipurpose computers for general use.

In the mid-1960's, along with the increase in processing volume and diversification of usage, the family series machines became dominant. Manufacturers provided various scales of

computers, ranging from small to medium, and later from small to large. All members of a family could share the same software. This was the age of the "line-oriented computer." NEC offered numerous models with the name of the NEAC-2200 series.

This family series had a big advantage over "point-oriented computers" in that software assets could be consolidated based on a consistent system design philosophy. NEC called this the "one machine concept." The vertical integration of the NEAC-2200 series oriented itself to centralized processing systems using large-scale computers. By the latter half of the 1970's, excessive centralization caused the hardware to become very large and complex, and at the same time, made it inevitable that software too must become voluminous and complicated. As a result, system flexibility and reliability were reduced and a remarkable amount of manpower was required for maintenance.

A distributed processing system was conceived to overcome these problems by processing information at the site of its generation and usage. In place of single super large computer, a number of comparatively small-scale computers and intelligent terminals incorporating computer functions are integrated through communications lines. This offsets the demerits of vertical integration and makes systems more economical. The "area-oriented computer" has both vertical and horizontal integration.

Based on this concept, NEC developed "DINA", Distributed Information processing Network Architecture, the architecture that incorporates the knowledge and experience gained from NEC's original communications technologies.

"C & C" As computers approach communications, communications is beginning to approach computers. Communications equipment has become digitalized and communications services have developed from the simple transfer of information to higher level services including processing and storage of information. In 1977, succeeding the announcement of "DINA" in the previous year, NEC announced the NEAX-61, the first digital switching system for telephone offices. In that year, I announced the concept

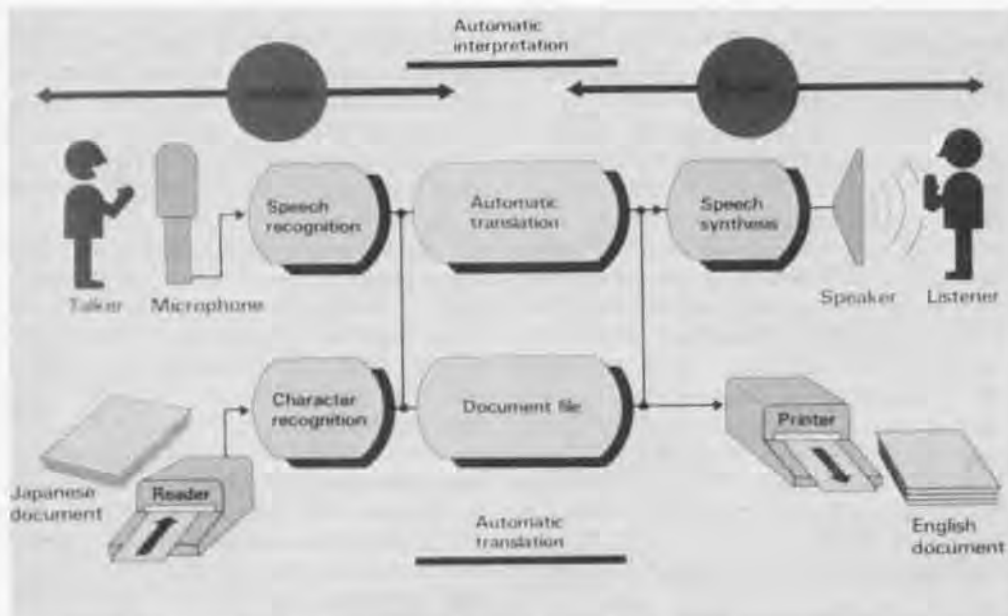

An Image of Automatic Interpretation Systems

of the merger of computers and communications at the Atlanta INTELCOM 77. Then in 1978, at the third U.S.A.-Japan Computer Conference held in San Francisco, I announced this concept by using the phrase "C&C," which stands for the integration of computers and communications. Since then I have made "C&C" NEC's corporate identity.

From the technological viewpoint, "C&C" is the integration of computers and communications technologies. From the view point of "C&C"'s influence in social and economical world, it can be summarized in three points.

First, "C&C" can become an information-related infrastructure of world-wide scale.

Second, the constituent elements of this infrastructure will serve as valuable tools for solving various social problems, promoting economic and cultural development, and contributing to international mutual understanding.

Third, the effective use of information resources can overcome the limitations that restrict the optimum utilization of the world's natural resources.

"Man and 'C & C'" In the 1980's, "C&C" entered a new phase. The realizable ideal is that anyone, not just experts, can fully and easily utilize information systems in order to obtain a richer social and cultural life.

Human effort is facilitated by software. Due to the rapid increase in the amount of software required, a software crisis exists. "C&C" can only pro-

duce desirable benefits for humanity if software is produced efficiently.

"'C & C' and the World" The activities of AT&T and IBM show that the convergence of Computers and Communications is indeed the actual trend of the industry. AT&T, the world's largest telecommunications company, has entered the computer business. And IBM, the giant of the computer industry, is aggressively trying to enter the communications field.

Even now, the world's industrial map is in the process of being reorganized, centering around information and knowledge and equipment for handling them. NEC has been in the telecommunications business since its establishment over 86 years ago, and in the computer and semiconductor businesses for some 30 years. Because of this, NEC has been able to perceive and respond to major market shifts precisely.

Automatic Interpretation Telephones Throughout my 56 year career at NEC, I have believed it is my mission to create conditions by which anyone can talk to anyone else, at any place and any time. In the world today, mutual understanding between nations is terribly insufficient, and it can only be overcome through the unrestricted flow of information.

I have always thought that automatic interpreting telephone systems would be one of the keys to fully realizing "C&C." When this system is actualized, if the other party speaks to

me in English, I can hear those words in Japanese, and vice versa, my words in Japanese will be conveyed to the other party in English.

If this automatic interpretation telephone system comes into wide use, it will not only make daily business extremely convenient, but it also will contribute greatly to the maintenance of world peace. Because of the development of transportation and communications, people throughout the world have become able to communicate with each other at the grass roots level like never before in history. This means that people of one nation are coming to understand the ways of thinking and life styles of peoples of other nations. As a result, all the people of the world are beginning to recognize that they are all part of one humankind. If the barriers of language are removed by this automatic interpretation telephone system, communications and exchange at the grass roots level will further expand, and world peace may be realized.

The Collection

New acquisitions during the period June 15, 1984 to August 31, 1985

Prior acquisitions are listed in Computer Museum Report numbers 1,5 and 10

Computers

Amdahl Corporation,
Amdahl 470V/6 Computing System,
(X436.84)
Gift of Major Computer, Inc.

Apollo Computer, Inc.,
Apollo DN100 Workstations,
2 nodes, (X533.84)
Gift of Apollo Computer, Inc.

Apollo Computer, Inc.,
Apollo Domain DN300-1MB
Workstation, (X424.84 (A-D))
Gift of Apollo Computer, Inc.

Apple Computer, Inc.,
Apple II Plus Computer, (X539.84)
Gift of Katherine Schwartz

Apple Computer, Inc.,
Apple Lisa, (X496.84) (X497.84)
(X498.84)
Gift of Apple Computer, Inc.

Apple Computer, Inc.,
Apple Macintosh, (X499.84)
(X500.84) (X501.84)
Gift of Apple Computer, Inc.

Autographix, Inc.,
Autographix 200 System, (X590.85)
Gift of Autographix, Inc.

Commodore Business Machines, Inc.,
Commodore 64 Personal
Computer, (X366.84 (A-E))
*Gift of Commodore Business
Machines, Inc.*

Commodore Business Machines, Inc.,
Commodore PET 2001 Personal
Computer, (X364.84)
*Gift of Commodore Business
Machines, Inc.*

Commodore Business Machines, Inc.,
Commodore PET 2001 Personal
Computer, (X445.84)
Gift of Microsoft Corporation

Commodore Business Machines, Inc.,
Commodore VIC-20 Computer,
(X367.84)
*Gift of Commodore Business
Machines, Inc.*

Compaq Computer Corporation,
Compaq DeskPro Computer,
(X481.84) (X482.84) (X483.84)
*Gift of Compaq Computer
Corporation*

Compaq Computer Corporation,
Compaq Portable Computer,
(X484.84) (X485.84) (X486.84)
*Gift of Compaq Computer
Corporation*

Computer Controls Corporation,
DDP-116 General Purpose
Computer, (X578.85)
*Gift of Boudreau Computer
Services, Ltd.*

Computer Products Corporation,
CP 10/50 General Purpose Analog
Computer, (X552.85)
Gift of Per A. Holst

Control Data Corporation,
Little Character, (X437.84)
*Loan from Control Data
Corporation*

Data General Corporation,
Data General Desktop Model 10,
(X479.84) (X480.84)
Gift of Data General Corporation

Data General Corporation,
Data General Eclipse, (X502.84)
Gift of Data General Corporation

Digital Equipment Corporation,
Digital PRO 350 Computer,
(X435.84)
*Gift of Digital Equipment
Corporation*

Digital Equipment Corporation,
Rainbow, (X478.84); Rainbow 100,
(X477.84); Rainbow 100+, (X476.84)
*Gift of Digital Equipment
Corporation*

Digital Group, The,
Digital Group System 2,
26K Computer, (X555.85)
*Gift of St. George's School,
Newport RI*

Evans and Sutherland Computer
Corporation,
Evans and Sutherland Line
Drawing System 2, (X540.84)
Gift of Case Western University

Gould, Inc.,
Gould 32/55 Computer System,
(X529.84); Gould 8600 II Computer
System, (X528.84)
Gift of Gould, Inc.

Hewlett-Packard Company,
HP150 Personal Computer,
(X432.84) (X433.84) (X435.84)
Gift of Hewlett-Packard Company

Honeywell, Computer Control
Division,
Honeywell H316 General Purpose
Digital Computer [Kitchen
Computer], (X579.85)
*Gift of Boudreau Computer
Services, Ltd.*



Amdahl 470V/6, by Amdahl Corporation, 1975. In 1975 Gene Amdahl, a major contributor to the design of the IBM System 360, announced his own company's first computer, the 470V/6. Amdahl's strategy was to produce computers which would out-perform IBM's top systems, but be completely compatible with them. In this the V/6 was successful, competing with the IBM 370/165 and 168. While selling for approximately the same amount (\$4 million), the V/6 was rated at 3.6 million instructions per second with memory expandable up to 16 megabytes, making it almost twice as powerful as the 370/168.

The Museum's machine is serial number 2, the second machine produced by the Amdahl Corporation. Originally installed at the University of Michigan, the unit was later bought by American Cyanamid of New Jersey, and then by Major Computer, Inc.

*Donated by Major Computer Inc.,
Minnetonka, Minnesota*

IBM,
IBM Personal Computer XT,
(X430.84) (X431.84) (X562.85)
Loan from IBM

IMSAI Manufacturing Corporation,
IMSAI 8080 Microcomputer System,
(X589.85)
Loan from Mike Miller

Kaypro Corporation,
Kaypro 10 Computer, (X487.84)
Gift of Kaypro Corporation

MASSCOMP, Inc.,
MASSCOMP MC-500 Computer,
(X515.84)
Gift of MASSCOMP, Inc.

Microdata Corporation,
Microdata EXPRESS Computer
Prototype, (X377.84 (A-D))
Gift of Ing. C. Olivetti C. S.p. A.

MOS Technology, Inc.,
KIM-1 Microcomputer, (X365.84)
*Gift of Commodore Business
Machines, Inc.*

National Cash Register Company,
NCR 399 Computer, (X451.84)
Gift of Bay State York Company

National Semiconductor
Corporation,
SCMP Development System
Mother Board, (X386.84); SC/MP
Development System Mother Board
mounted on box, (X383.84)
*Gift of National Semiconductor
Corporation*

NEC Corporation,
NEC APC III Personal Computer,
(X494.84) (X495.84)
Gift of NEC Systems Laboratory

NEC Corporation,
NEC PC-8000 Computer, (X446.84)
Gift of Microsoft Corporation

NEC Corporation,
NEC TK-80, (X447.84)
Gift of Microsoft Corporation

Osborne Computer Corporation,
Osborne 1 Computer,
(X362.84) (X363.84)
*Gift of Osborne Computer
Corporation*

Packard-Bell Company,
Packard-Bell 250 Computer,
(X463.84)
Gift of Dr. Claude Kagan

Philips Business Systems,
Philips P359 Computer, (X594.85)
*Gift of New England Provision
Company*

Polymorphic Systems,
Polymorphic System 8813
Computer, (X614.85)
Gift of Robert and Margaret Wesley

SCELBI Computer Consulting, Inc.,
SCELBI-8H Mini-computer,
(X574.85)
Gift of Carlton B. Hensley

Sinclair Research Limited,
Sinclair ZX80 Personal Computer,
(X513.84); Sinclair ZX81 Personal
Computer, (X514.84)
Gift of Sinclair Research Limited

Spiras Systems, Inc.,
Spiras-85 Computer, (X549.85)
*Gift of Dartmouth College
Radiophysics Laboratory*

Sutherland, James,
ECHO IV Home Computer,
(X509.84)
Gift of James Sutherland

Univac Division, Sperry Rand
Corporation,
Univac Phoenix Computer,
(X563.85)
Gift of Herbert Teager

Wang Laboratories,
Wang 2200 System, (X602.85)
Gift of Martin Levine

Wang Laboratories,
Wang PIC (Professional Image
Computer) System, (X566.85)
Gift of Wang Laboratories



Scelbi 8H, by Scelbi Computer Consulting Inc., 1974. The Scelbi 8H (pronounced Sel-bee) was the first commercially-advertised computer based on a microprocessor. The first advertisement for the Scelbi appeared in March 1974, seven months before the debut of the Altair in January 1975. Nat Wadsworth, the Scelbi's chief designer, thought the computer would be used in scientific, electronic, and biological applications; hence, the abbreviated name Scelbi.

Designed for the hobbyist, the Scelbi 8H was based on the Intel 8008 microprocessor and was available both in kit form and fully assembled. It had 4K of internal memory, cassette tape and teletype interfaces, and a CRT based on an oscilloscope. Later on a combination monitor, editor, and assembler in ROM became available. Starting in April 1975, the company made versions with up to 16K of memory. These models were called Scelbi 8B's, the "B" standing for "business."

Wadsworth, an engineer for General DataComm Industries of Danbury, Connecticut, became interested in the idea of a small computer for personal use after attending a seminar given by Intel on the 8008. He and several co-workers decided to build such a computer and in 1973 he left his job to work full-time on the computer. Scelbi

Computer Consulting, Inc. of Milford, Connecticut was incorporated in August of that year. The development of the computer suffered a severe setback when Wadsworth suffered a heart attack in November 1973. The company persisted, however, and announced their product in April 1974. The 8H was first advertised in the ham radio magazine *QST* because Wadsworth realized that many amateur radio hobbyists were "died-in-the-wool electronic enthusiasts." Just as orders started to roll in, Wadsworth had a second heart attack. In all, Scelbi Computer Consulting sold roughly 200 computers, losing \$500 per unit.

From his hospital bed Wadsworth wrote a book to accompany the Scelbi 8H, *Machine Language Programming for the 8008*. The company published the book by offset printing a teletype output. The book was a hit; thousands were ordered. This success prompted Scelbi to concentrate on software for 8008- and 8080-based computers, such as the Altair. This shift in emphasis ultimately made the the company a profitable concern, but meant the early demise of the Scelbi 8's.

Donated by Carlton B. Hensley

[Based on "The Early Days of Personal Computer," by Stephen B. Gray in *Creative Computing*, November 1984.]

Subassemblies and Components

Burroughs Corporation, Electrodata division, Burroughs 205 Modules, (X524.84); Burroughs 205 Magtape Hybrid Read Amplifier Modules, (X525.84)
Gift of James Williams

Computer Image Corporation, Scanimate Video/Pulse Distribution Amplifier Module, (X401.84)
Gift of Peter Sorensen

Control Data Corporation, CDC 6600 "Cordwood" Module, (X402.84)
Gift of Control Data Corporation

Cray Research, Inc., Slice of Cray I, (X438.84)
Gift of Cray Research, Inc.

Digital Communications Associates, Inc., IRMA board: First coaxial cable interface for micro-to-mainframe communications, (X580.85)
Loan from Dr. W. Waverly Graham, III, Digital Communications Associates, Inc.

Digital Equipment Corporation, MicroVax II: Central processor and floating point integrated circuits, mounted and unmounted, (X581.85)
Gift of Digital Equipment Corporation

Eckert-Mauchly Computer Corporation, Univac I Arithmetic Unit, (X491.84)
Loan from the Smithsonian Institute, National Museum of American History

Harris Semiconductor, Harris 6120 Microprocessor (PDP-8 on a chip), (X439.84)
Gift of John Clarke

IBM, IBM 360/30 Console, (X461.84)
Loan from IBM

Minneapolis Honeywell Regulator Company, DATAmatic Division, Datamatic 1000 module, (X597.85)
Gift of Alvin Landsman

National Semiconductor Corporation, SC/MP CPU Boards, (X384.85) (X385.84) (X388.84) (X389.84); IMP-16C CPU Board, (X380.84); IMP-8C CPU Board, (X379.84); DP8350 Chip mounted in Carrier, (X397.84); PACE CPU Board, (X390.84); PACE Application CPU Card, (X391.84); SO2321 Water, (X393.84); SO3001 Water, (X395.84); SO1603 Water, (X394.84); DP8350 Water, (X396.84)
Gift of National Semiconductor Corporation

NEC Corporation, NEAC-1101 Parametron subunit, (X417.84); NEAC-2203 Gate Package, (X415.84); NEAC-2203 Dynamic Flip-Flop Package, (X414.84)
Gift of NEC Corporation

Philbrick Researches Inc., George A., Vacuum Tube OP Amplifier (model K2-W), (X375.84)
Gift of Michael Callahan

Potter Instrument Company, Inc., Potter Tape Control Unit logic cards, (X545.85 (A-C))
Gift of Keith Gobeski

Remington Rand Corporation, LARC Power Supply Regulator Module, (X455.84); LARC Servo Thyatron, (X456.84)
Loan from Lawrence Livermore National Laboratory

Texas Instruments, Inc., Texas Instruments Microminature Computer integrated circuits, (X464.84)
Gift of Texas Instruments, Inc.

Sinclair ZX80 and ZX81, by Sinclair Research Ltd, 1980. Sinclair Research Limited, founded by Sir Clive Sinclair, announced the ZX80 in February of 1980. Based on the Zilog Z80A microprocessor it had an internal RAM of 1K. A 4K integer version of BASIC was also available in ROM. The machine used a membrane keyboard for input and a domestic TV as its display device. Programs and data could be stored on standard cassette tapes.

The ZX80 sold for under 100 pounds in the UK, \$199 in the US—a major price break-through. This compared to about \$500 for the TRS-80 and about \$1100 for an Apple II with 16k of RAM. Manufacturing cost was kept low by use of the membrane keyboard and the single board design, in which all the circuitry including memory, ROM, CPU, a total of 22 chips were mounted on just one printed circuit board.

The ZX81, also introduced in late 1980, had only 5 chips including the ROM, microprocessor, two 512 byte RAM's and the uncommitted logic array (ULA). The use of the largely untried ULA's (also known as gate-arrays) was a novel and bold move. The ULA performed all the functions not carried out by the processor, RAM or ROM, earning it the nickname "dogsbody." It replaced nearly 20 of the ZX80's chips. The ROM had a floating point Basic and, in contrast to the ZX80, the ZX81 could maintain a display on the screen while the processor was performing another task. This made animation possible, a major factor for game-playing users. In 1981 a 16k RAM became available for the ZX81 for just under \$100.

At the end of 1981, Timex took over the US marketing of Sinclair's machines. The ZX81 was renamed Timex/Sinclair 1000 and sold for \$99.95.

These models brought the computer well within the mass retail consumer market for the first time. Hundreds of thousands of ZX80's and ZX81's were sold—more than any other computer at the time.

Donated by Sinclair Research Limited of Boston.



Memories

AT&T Bell Laboratories,
AT&T 1K & 4K RAM wafer and
chips, (X577.85)
Loan from AT&T Bell Laboratories

AT&T Technology, Inc.,
AT&T 256K wafer, (X467.84); AT&T
64K RAM chip, (X468.84)
Gift of AT&T Technology, Inc.

Commodore Business Machines, Inc.,
Commodore 1541 Disk Drive,
(X425.84)
*Gift of Commodore Business
Machines, Inc.*

Data Disc, Inc.,
Data Disc 7200 Series Disc Memory,
(X449.84)
*Gift of Houghton Mifflin Company,
TSC Division*

Digital Equipment Corporation,
DECTAPE, (X601.85)
Gift of Ivan E. Sutherland

Digital Equipment Corporation,
Digital Core Memory Stack,
(X470.84)
*Gift of Digital Equipment
Corporation*

Digital Equipment Corporation
Reader Head from 25,000th
Winchester Disk Drive, (X404.84)
*Gift of Digital Equipment
Corporation, Colorado Springs*

Fabri-tek, Inc.,
Core Memory Stack (36-bit)
from MA10 Memory used on
KA10, (X452.84)
*Gift of University of Queensland,
Australia*

Hewlett-Packard Company,
HP 9100A ROM layer pre-chip,
(X471.84)
Gift of Hewlett-Packard Company

Hitachi, Ltd.,
Hitachi 256K DRAM (unpacked chip
package), (X569.85)
Gift of Hitachi America

Honeywell Information Systems,
Honeywell Model 58 miscellaneous
circuit boards, Read-Only Memory
and Magnetic Core Memory,
(X598.85)
Gift of Thermo Electron Corporation

IBM,
IBM 64K-bit RAM chips, unmounted
and w/mounting double layer
package, (X543.85)
Gift of IBM

IBM,
IBM 729 Tape Drive, (X460.84)
Loan from IBM

IBM,
IBM System 3 96-column punched
cards, (X428.84)
Gift of Allied Plywood Corporation

Intel Corporation,
Intel chip collection, (X462.84)
Gift of Intel Corporation

MIT,
Whirlwind Electrostatic Storage
Tube, (X412.84)
Loan from Robert R. Everett

Mostek, Inc.,
Mostek 4096 2-inch wafer, (X582.85)
Gift of Mostek, Inc.

Mostek, Inc.,
Mostek 4K memory chips, (X561.85)
Gift of Mostek, Carrollton, TX

Mostek, Inc.,
Mostek MK4096 masks, rubylith,
and MK4096 wafer, (X444.84)
Gift of Howard Sussman

National Semiconductor
Corporation,
PACE memory card, (X392.84);
SC/MP memory board, (X387.84);
IMP memory board, 16 bit,
(X382.84); IMP-16L memory board,
(X381.84)
*Gift of National Semiconductor
Corporation*

NEC Corporation,
NEC 64K & 256K DRAM chips,
unmounted and mounting pins,
(X583.85)
Gift of NEC Information Systems, Inc.

Nixdorf Computer Corporation,
Nixdorf 820/23 Rod Cell Memory
Board, (hardwired insurance
program), (X613.85)
Gift of Richard S. Beers

Tektronix, Inc.,
Tektronix 564 storage tube cross
section, (X411.84)
Gift of Tektronix, Inc.

Sub-Category: Pre-computing or Non-Computer Related Memories

Valenta, Jerry & Sons, Inc.,
Jacquard Punched Cards, (X519.84)
Gift of Jerry Valenta & Sons, Inc.

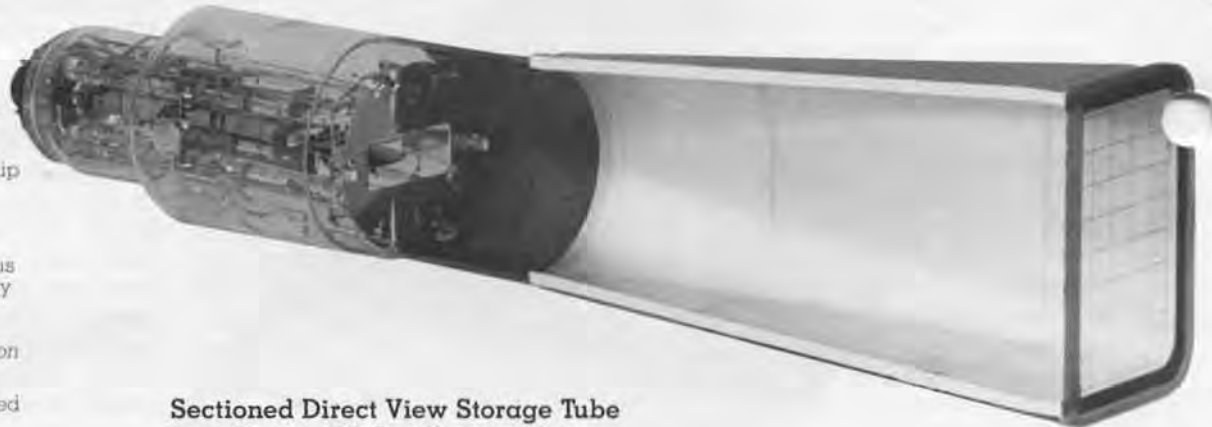

Sectioned Direct View Storage Tube from Model 564 Oscilloscope by Tektronix Inc., 1962. The direct view storage tube (DVST) was invented by Robert H. Anderson in the late 1950's. First introduced in the Tektronix model 564 oscilloscope, it enabled the display of transient electrical signals. It was soon realized that DVST's could be used as display terminals with computers, and by 1969 Computer Displays Inc., Computek Inc. and Tektronix Inc. were all selling DVST terminals based on Tektronix tubes.

The key feature of the DVST is its ability to store a vector image without the need for constant refreshing. This brought down the price of computer graphic displays from, say \$80,000 for the IBM 2250, to under \$10,000, causing a vast expansion in the availability and use of computer graphics.

A DVST contains a writing gun, flood guns and a phosphor storage screen. The storage screen has an outer transparent conducting layer and an inner phosphor layer. When the write gun's beam is switched on it creates a positive charge where it strikes the phosphor as a result of secondary electron emission. This attracts the electrons from the flood guns which are on continuously, and causes the areas struck by the write gun's beam to luminesce without the need for refresh. The screen is erased by making the whole target more positive, effectively writing the whole screen and then lowering the potential, erasing the screen.

*Donated by Tektronix Inc.,
Beaverton, Oregon*

Crystal Globe, MIT Electronic Systems Laboratory, 1963. In 1964 researchers at MIT's Electronic Systems Laboratory (ESL) first demonstrated a system capable of online graphical input and output to a computer. They used a modified DEC 330 scope connected under the Project MAC Compatible Time-Sharing System to an IBM 7094. The goal was to improve man-machine interaction to the point where computer-aided design became feasible. A key development was the devising of 'natural' methods

of input to the computer; the crystal globe epitomises this effort.

"... since individual knobs are inconvenient when two or more actions must be coordinated, such as rotating about more than one axis simultaneously, a three-dimensional input device has been devised. This unit, called the 'globe', has spring-loaded limited rotation about three mutually perpendicular axes. Each axis has a simple cam and microswitch encoder, with three discrete codes each side of

neutral. The globe is used as a three-step rate control, with the rate scaling entirely under program control. [The globe is] read only by the computer, and [has] no wired console function. Programmed interpretation of [the globe]... gives maximum flexibility at the cost of a very small amount of computer time."

John Ward, project member,
1966 AFCEA Convention

On loan from John Ward, MIT

Transducers

Adage, Inc.,
Adage 3006 Display Processor,
(X504.84)

Gift of Adage, Inc.

ALTEK Corporation,
APACHE Digitizing Cursor
Prototype, (X454.84)

Gift of ALTEK Corporation

Bolt Beranek and Newman, Inc.,
Grafacon 1010A Digitizing Tablet,
(X550.85)

*Gift of Dartmouth College
Radiophysics Laboratory*

California Computer Products, Inc.,
Calcomp Model 560R Drum Plotter,
(X565.85)

Gift of Herbert Teager

Control Data Corporation,
Data Terminal, (X458.84)

*Loan from Control Data
Corporation*

Dataproducts Corporation,
Dataproducts Matrix Printer, Model
M100, (X537.84); Dataproducts
BP-1500 Band Printer, (X505.84)

Gift of Dataproducts Corporation

Digital Equipment Corporation,
Dectalk, (X472.84) (X473.84)
(X474.84) (X475.84)

*Gift of Digital Equipment
Corporation*

Digital Equipment Corporation,
DIGI, (X541.85)

*Gift of Digital Equipment
Corporation*

Grinnell Systems Corporation,
Grinnell GMR 27-20 Display
System, (X508.84)

*Gift of Grinnell Systems
Corporation*

Hewlett-Packard Company,
Hewlett-Packard 7586B pen plotter,
(X503.84)

Gift of Hewlett-Packard Company

IBM,
IBM Model 016 Key punch, (X595.85)

Gift of Greydon Carl Freeman

IBM,
IBM Plasma Display, (X493.84)

Loan from IBM

Lexidata, Inc.,
Lexidata LEX 90/35 graphics
display system, (X510.85)

Gift of Lexidata, Inc.

Micro Control Systems, Inc.,
Space Tablet, (X512.84)

Gift of Micro Control Systems, Inc.

MIT Electronic Systems Laboratory,
Crystal Ball from ESL Display
Console, (X405.84)

Loan from John E. Ward

MIT Electronic Systems Laboratory,
Focusing Light Pen from ESL
Display Console, (X406.84)

Loan from John E. Ward

Pencept, Inc.,
Penpad Tablet, (X488.84)

Gift of Pencept, Inc.

Polaroid Corporation,
Polaroid Video Printer, Model 8,
(X593.85)

Gift of Polaroid Corporation

Rand Corporation,
Stylus for the Rand Tablet,
(X413.84 A-B); Rand Graphic Input
Tablet, (X450.84)

Gift of Rand Corporation

Rand Corporation,
Rand Graphic Input Tablet and
Stylus, (X564.85)

Gift of Herbert Teager

Rand Corporation,
Rand Tablet Mesh of Copper Wire,
(X544.85)

Gift of Ivan E. Sutherland

Remington Rand Corporation,
Univac 1 Unityper, (X490.84)

*Loan from the Smithsonian
Institute, National Museum of
American History*

Scriptel Corporation,
Scriptel Transparent Digitizing
Tablet, (X506.84)

Gift of Scriptel Corporation

Summagraphics Corporation,
BitPad One, (X511.84)

*Gift of Summagraphics
Corporation*

Tektronix, Inc.,
Oscilloscope Type 564B, (X410.84);
Tektronix 4115B Terminal, (X459.84)

Gift of Tektronix, Inc.

Teletype Corporation,
Teletype Model 35, ASR,
(X369.84); Teletype, (X369.84)

(X370.84); Teletype 15AA Typing
Unit w/ Stand, (X372.84); Teletype
Transmitter/Distributor,
(X373.84 A-B)

Gift of Matthew Reilly

Teletype Corporation,
Teletype ASR 33 w/ stand, (X448.84)

*Gift of Houghton Mifflin Company,
TSC Division*

Teletype Corporation,
Teletype Model 33, (X429.84)

*Gift of Michael Tardiff
and Stephen Russell*

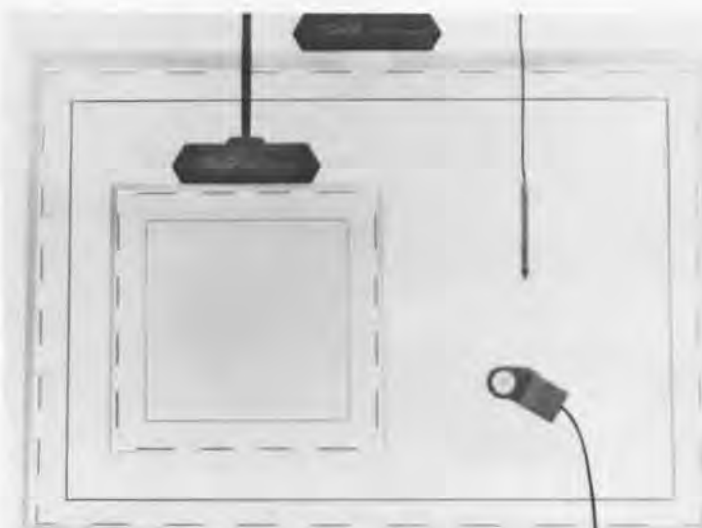

Transparent Digitizing Tablet, by Scriptel Corporation, 1984. A transparent tablet allows original artwork or photographs to be placed underneath the tablet—protected from scratching or staining. The tablet can be mounted onto a flat display screen enabling video images to be digitized. With a frosted glass finish, a slide could be back-projected onto the tablet for digitizing. A major application is the digitization of medical images, particularly X-rays.

The rear of the glass tablet is coated with a continuous layer of resistive material, indium tin oxide. One edge of the tablet is grounded while an AC voltage is applied to the opposite edge. The puck contains a receiver which produces a signal through capacitive coupling when placed on the tablet. The strength of the signal yields the coordinate along one axis which is checked by reversing the grounded and live edges. The process is repeated for the complementary pair of edges, yielding the second coordinate. 150 coordinate pair measurements are made per second.

*Donated by Scriptel Corporation,
Columbus, Ohio*

Teletype Corporation,
Teletype Model 5, (X567.85)
Gift of Stephen Dum

Unknown,
Keyboard from unidentified
machine, (X609.85)
Gift of Gordon and Gwen Bell

Visual Technology, Inc.,
Visual 550 Monitor, (X489.84)
Loan from Visual Technology, Inc.

Wright Line, Inc., The,
Wright Portable Punch, Model
2600, (X584.85)
Gift of Allan Sadoski

Calculators

Commodore Business Machines, Inc.,
Commodore 500E Calculator,
(X554.85)
Gift of Baynes Electric Supply
Company

Comptometer Corporation,
Comptometer, (X465.84)
Gift of Gordon and Gwen Bell

Faber-Castell Company,
CASTELL-Addiator DRP Slide Rule,
(X361.84)
Gift of Joseph Santangelo

FUN Incorporated,
Hokey's Secret Code Maker and
Decoder, (X588.85)
Gift of Edward Dillon

Friden Corporation,
Friden Model 132 Calculator,
(XB23.78)
Gift of Gordon and Gwen Bell

IBM,
IBM 632 Electronic Typing
Calculator, (X571.85)
Loan from Joseph Keller

IBM,
IBM Hexadecimal Adder, (X557.85)
Gift of Fred Macchio

IBM,
IBM Machine Load "Computer"
Slide Rule, (X612.85)
Gift of Richard S. Beers

IBM,
IBM Non-Listing Tabulator, (X591.85)
Gift of Mr. and Mrs. William
Dobratz

Keuffel & Esser Company,
Log Log Duplex Slide Rule,
(X360.84)
Gift of Joseph Santangelo

Layton, C & E,
Tates Arithmometer, (X559.85)
Gift of Mrs. David G. Stone

Marchant Calculating Machine
Company,
Marchant Calculator, (X399.84)
Gift of Dick Rubinstein

Monroe Calculating Machine
Company,
Mechanical Calculating Machine,
by Monroe, black with keys of
varying height, (X592.85)
Gift of Warren J. Buck and
Arthur Milinowski

Monroe Calculating Machine
Company,
Monroe 326 Scientist, (X547.85)
Gift of Henry C. Thacher and
University of Kentucky

Monroe Calculating Machine
Company,
Monroe #1 Adding Machine,
(XB90.79)
Gift of Gordon and Gwen Bell

Odhner,
Original Odhner Calculator,
(XB135.80)
Gift of Gordon and Gwen Bell

Odhner,
Original Odhner Calculator,
(X546.85)
Gift of Henry C. Thacher and
University of Kentucky

Olivetti, Inc.,
Olivetti Summa Quanta 20
Calculator, (XB86.79)
Gift of Gordon and Gwen Bell

Science Spectrum, Inc.,
Hexadecimal-Decimal Slide Rule
Calculator, (X586.85);
Octal-Decimal Slide Rule
Calculator, (X585.85)
Gift of Edward Dillon

Sharp Corporation,
Elsi MATE EI-8048 Electronic
Calculator Soroban 1, (X538.84)
Anonymous Gift

Sinclair Radionics Limited,
Sinclair Cambridge Memory
Calculator, (X359.84)
Loan from Jeremy Barker

Sumlock Anita Electronics Ltd.,
Anita 1000 LSI, (X553.85)
Gift of Brian Randell

Unknown,
Circular Slide Rule, (X587.85)
Gift of Edward Dillon

Unknown,
Resulta-9 calculator, (X536.84);
Resulta-BS7 calculator, (X535.84)
Gift of Lou Goodman

Von Reppert, R.,
Von Reppert Calculating Machine,
(X568.85)
Gift of Erwin J. and Richard W.
Reppert

Walker, R.H.,
Addist, The, (X523.84)
Gift of Ernst Halberstadt

Wang Laboratories,
Wang 320SE Calculator, (X576.85)
Gift of Kirtland Olsen

Wang Laboratories,
Wang 370 Programmable
Calculator, (X575.85)
Gift of Lorraine Olsen

Wang Laboratories,
Wang LOCI-2, (X520.84)
Loan from Wang Laboratories

Webb, C.H.,
Webb Adder, The, (X522.84)
Gift of Ernst Halberstadt



Prototype Von Reppert Calculating Machine. This artifact is truly one of a kind. It is a prototype of a calculating machine built by its inventor Richard von Reppert. Patented in 1918, the von Reppert calculator could perform "the four fundamental calculations, addition, subtraction, multiplication, and division, as well as other useful commercial work, in a practical manner." Von Reppert sold this and several other patents relating to mechanical office machines to the Underwood Company in 1920.

Over the course of his career von Reppert received over 40 patents either in conjunction with others or on his own. These include two patents issued by the German and French governments, and 8 for floating point arithmetic mechanisms for mechanical calculators. In addition to being a solo inventor, von Reppert also worked for the Underwood Company and IBM for many years.

Donated by Erwin J. and Richard W. Reppert

Miscellaneous Artifacts

Advance Watch Company,
Mini "Put Up" LCD Digital Clocks,
(X443.84 A-B)
Gift of J. Carberry

Dutton, Stephen,
Hologram Generated by Computer,
(X516.84)
Gift of Stephen Benton

Boeing Commercial Airplane
Company,
Carrier Wing Fitting Assembly-Off
Wing Escape Slide System:
computerized engineering model
used on Boeing 757, (X409.84);
Horizontal Tail-H5 from Boeing
wind tunnel model, (X407.84);
Splice Rib-Wing Tip: computerized
engineering model used on Boeing
727, (X408.84)
*Gift of Boeing Commercial Airplane
Company*

Celestron Associates, Inc.,
Fortran Infograph, (X556.85)
Gift of J.A.N. Lee

Cummins Corporation,
Cummins Conditioner, (X400.84)
Gift of Dick Rubinstein

Data General Corporation,
Data General Manufacture Exhibit
Collection, (X466.84)
Gift of Data General Corporation

Digital Equipment Corporation,
Glass Plates: Artwork for Agate or
VaxStation 300 PC board, (X548.85)
*Gift of Digital Equipment
Corporation*

Digital Equipment Corporation,
Micro T11 plot on mylar, (X603.85);
Micro T11 silicon wafers, (X604.85);
Micro T11 Engineering masks
metal layer interconnect,
polysilicon layer and diffusion
layer, (X606.85)
*Gift of Digital Equipment
Corporation*

Duckworth, Dr. Gregory,
IC clock (3 boards), (X441.84);
IC clock (1 board), (X442.84)
Loan from Dr. Gregory Duckworth

Dutton, Geoffery,
Hologram: Computer Animated
Population Density Map, (X517.84)
Loan from Geoffery Dutton

Honeywell, Inc.,
Sculptures composed of electronic
components: Buffalo, Fish, Dragon,
Grasshopper, Fox, and Rider on
Horseback, (X573.85)
*Loan from Honeywell Information
Systems, Inc.*

IBM,
IBM 1403 Printer Control Tape Rack,
(X608.85)
Gift of American Computer Group

IBM,
IBM Book of General Purpose Card
Samples, (X611.85); Paperweight
containing IBM transistor & 4
varying size ferrite cores encased
in clear lucite, (X610.85)
Gift of Richard S. Beers

Lester Associates, Inc.,
Univac I Model, (X492.84)
*Loan from the Smithsonian
Institute, National Museum of
American History*

Lockheed-Georgia Company,
Rudder Control Wheel of C141A
Transport Aircraft, (X542.85)
*Gift of Lockheed-Georgia
Company*

Melitta,
Teapot used for computer graphics
rendering, (X398.84)
Gift of Martin Newell

National Cash Register Company,
Flow Chart Template and Cards
used to program NCR390, (X469.84)
Gift of Antonia Oliver

NEC Corporation,
Keychain containing 1 Megabyte
NEC DRAM mounted &
unmounted, (X551.85)
*Gift of Howard Sussman and NEC
Electronics, Inc.*

Nike, Inc.,
Molds for casting rubber sole,
rubber soles and Nike Air running
shoes, (X530.84)
Gift of Nike, Inc.

Nolan, Jack,
Lunar Scan Reflectivity Model,
(X596.85)
Loan from Jack Nolan

Ohio Art, Inc.,
Etch-A-Sketch Screen, (X453.84)

Reeves and Sons, London,
Drawing Instrument Set of John
Heard, (X457.84)
Loan of MIT Museum

Resch, Ron,
Computer Art: "Van Leer Model,"
(X532.84); Computer Art: White
folded paper screen, (X420.84);
Computer Art: "Folded Triform,"
(X422.84); Computer Art: "Double
Yellow," (X421.84); Computer Art:
White folded paper screen,
(X419.84); Computer Art: White
folded paper screen, (X418.84);
Computer Art: "Folded Screen of
blue wool," (X423.84); Computer
Art: "Folded Metal Bird," (X531.84)
Loan from Ron Resch

Strangio, Christopher,
Transistor digital clock, (X440.84)
Loan from Christopher Strangio

Texas Instruments, Inc. and
IDEA Corporation,
Regency Radio-First commercial
transistor radio, (X374.84)
*Gift of Roger Webster and
Texas Instruments*

Unknown,
Button: "I Am A Human Being; Do
Not Fold, Spindle or Mutilate,"
(X427.84)
Loan from Jana Buchholz

Unknown,
COBOL Tombstone, (X572.85)
*Gift of Charles A. Phillips,
CODASYL*

Unknown,
Travelers 1401 Exhibit Collection,
(X376.84)
*Gift of Travelers Insurance
Company*

Xynetics, Inc.,
Xynetics Automatic Drafting
System 1100, (X518.84)

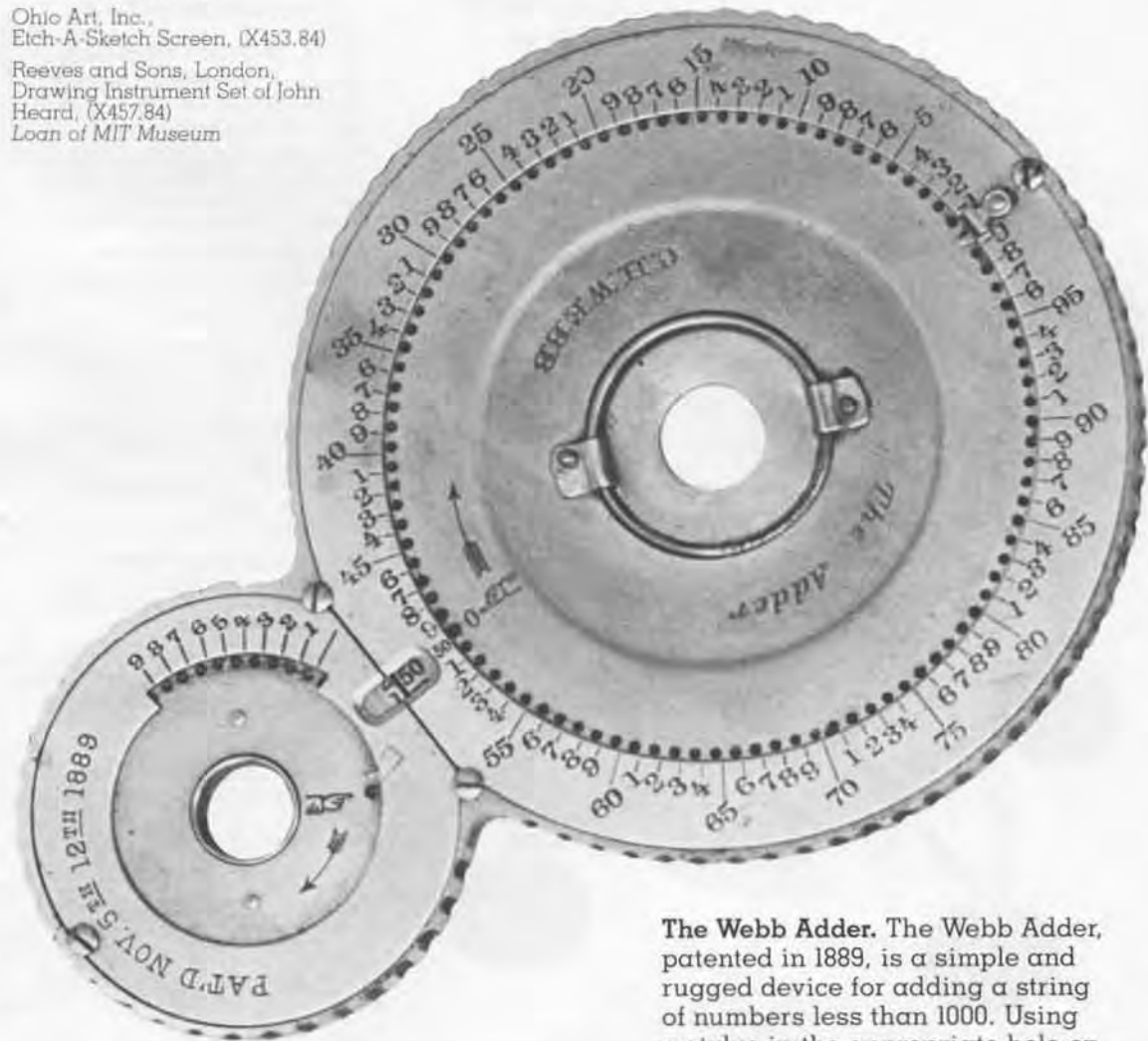

The Webb Adder. The Webb Adder, patented in 1889, is a simple and rugged device for adding a string of numbers less than 1000. Using a stylus in the appropriate hole on the larger wheel the user enters an addend in much the same way as a single digit is dialed on a telephone. When the sum of 100 is reached the larger wheel completes one revolution and advances the smaller hundreds wheel one unit by means of a simple ratchet. Results are displayed in the small window between the two wheels. The machine can add up to a sum of 4999.

Donated by Ernst Halberstadt

Special Purpose Microprocessor-based Devices

Axlon, Inc.,
Compurobot, (X600.85)
Gift of Axlon, Inc.

Centurion Industries, Inc.,
Digit Learning Arithmetic
Module, (X558.85)
Gift of Centurion Industries, Inc.

Ritam Corporation,
Monty (plays SCRABBLE
crossword game), (X599.85)
Gift of Ritam Corporation

Manuals and Documentation

Altair documentation,
DEC manuals and other
documentation, (85.4)
Gift of Peter Senn

Analogic Data-Conversion Systems
Digest and copies of six patents,
(X84.29)

Gift of Bernard M. Gordon

Annals of the History of
Computing, vols 6, numbers 3 & 4,
(85.3)

Gift of ACM

Assorted DEC manuals (given long
ago but finally recorded), (84.67)
Gift of Gordon Bell

Atlas I documentation, (84.69)
Gift of F.R.A. Hopgood

Automatic Language Translation
and A Study for the Design of an
Automatic Dictionary, (84.47)
Gift of Anthony Oettinger

Bell System documentation related
to the SAGE system, (84.77)
Gift of James Dresbach

BIT quarterly journal (1961-1984),
(84.49)
Gift of Carl-Erik Froberg

Burroughs, Bendix, CDC, IBM,
NCR, RCA, et. al. manuals and
documentation, (84.72)
Gift of Mario Barbacci

Collection of papers,
documentation and manuals
related to Computers in the
Utilities Industry, (84.76)
Gift of S.J. McMurray

Computer books (ca. 1950's), (84.37)
Gift of Nancy Stern

Computer books and manuals
(ca. 1950-1970) for use in the
Timeline exhibit, (84.39)
Loan from Dick Rubinstein

Computer Science Press recent
publications (11 library books),
(84.81)
Gift of Computer Science Press

Computer Security and Privacy
documentation, (85.16)
Gift of Jeffrey Bergart

Computer textbooks (six new titles
from Freeman Publishers), (84.63)
Gift of W.H. Freeman and
Company Publishers

Computing Mechanisms and
Linkages, by Antonin Svoboda,
(85.2)
Gift of Ted Kuklinski

Control Data Corporation reference
manuals and booklets, (84.55)
Gift of Control Data Corporation

Datamation 1960-1979, Journal of
ACM 1959-1979, Computing
Reviews 1965-1980,
Communications of the ACM
1965-1976, (84.66)
Gift of Kathryn Erat

Digital Computing Systems by
S. Williams and Theory of the
Flexagon by A.S. Conrad, (84.82)
Gift of Shag Graetz

Digital Equipment Corporation
manuals, documentation and other
computer related papers, (85.22)
Gift of Digital Equipment
Corporation

Early IBM Computers: Edited
Testimony by Cuthbert C. Hurd,
(84.44)
Gift of Lore Shaper

EDP Industry and Market Report
(nineteen bound volumes), (84.36)
Gift of Patrick W. McGovern

Electronic Design,
"Electro-Technology," "EDN," "EEE,"
"Electronic Industries" magazines
(near complete sets), (85.14)
Gift of Kirtland Olsen

Electrons and Holes in
Semiconductors by William
Shockley, (84.57)
Gift of Tony Crugnola

Ferranti documentation and
manuals, (84.33)
Gift of F.R.A. Hopgood

FORTRAN, COBOL & Whirlwind
xeroxed copies of documentation,
(84.41)

Gift of Jean E. Sammet

GE 225 documentation and other
manuals, (85.7)
Gift of Woods Hole Oceanographic
Institution

General Electric 1984 Press Kit,
(84.54)
Gift of General Electric Information
Services

Guide to Fortran Programming,
(84.35)
Loan from Dick Rubinstein

Harvard Newsletter on Computer
Graphics, vols 1, #1-5, #11, (84.84)
Gift of Stanley Klein

Herman Hollerith related
documents, (85.10)
Gift of Geolfrey Austrian

HP-65 Calculator documentation,
(85.1)
Gift of Stephen Gross

IBM 1360 Photo-digital Storage
System Manuals, (85.15)
Gift of Clarence Badger

IBM 610 manual of Operation and
programming sheets, (84.59),
Gift of W. Bruce Blattenberger

IBM 701 Thirtieth Anniversary Issue
of the Annals, (85.11)
Gift of Lore and Hans Shaper

IBM, NCR et. al. documentation
and ephemera, (85.21)
Gift of Richard S. Beers

IEEE Micro February 1984 issue,
(84.43)
Gift of Robert L. Morris

Illiac IV documentation, (84.70)
Gift of John Day

Lawrence Livermore National
Laboratory Press Kits, (85.8)
Gift of Lawrence Livermore
National Laboratory

Microdata EXPRESS Computer
documentation, (84.32)
Gift of Olivetti, Inc.

MIT ESL Crystal Ball and Focusing
Light Pen documentation, (84.45)
Loan from John E. Ward

Mr. Babbage's Secret—The Tale
of a Cypher—and APL, (84.43A)
Gift of Ole Immanuel Frankson

NEC computer documentation and
brochures, (84.53)
Gift of NEC Corporation

Neiman-Marcus Honeywell Kitchen
Computer Advertisement, (85.17)
Gift of Alan Frisbie

Princeton University Library
Chronicle (w/ article on Pierce
Electrical Design), (84.42)
Gift of Ken Ketner



Digitator, by Centurion Industries, 1974. This is not a UFO or a highly advanced computer for space exploration. It is digitator, probably the first educational tool based on a microprocessor. Built around the Intel 4004 processor in 1974 digitator claimed to be a "flexible and challenging means of testing the arithmetic abilities of elementary school children." By adjusting the two side knobs the teacher or student can set the difficulty and length of a series of problems. Stu-

dents answer problems posed to them on the display panel by entering a number on the keypad. Correct answers are rewarded by a happy face, incorrect ones by a sad face, and at the end of the exercise digitator displays the number of problems correctly answered.

Over 100,000 have been sold worldwide.

Donated by Centurion Industries, Inc.,
Redwood City, California

Programmer's card, manuals and other documentation for various machines, (84.50)
Gift of Geoff Feldman

Programmer's reference cards for AN/FSQ-7, IBM 704, 709, 1401, et. al., (84.78)
Gift of Philip H. Dorn

Programs for an Electronic Digital Computer by Wilkes, Wheeler, and Gill and Arithmetic Operations in Digital Computers by R.K. Richards, (84.61)
Gift of Gordon Bell

Proximity fuse and Project Tinkertoy documentation, (84.48)
Gift of National Bureau of Standards

Radio Electronics Mark-8 microcomputer manual, SCELBI-8H user's manual, (84.74)
Gift of David Mallory

Rand Tablet documentation, (84.52)
Gift of The Rand Corporation

SAGE documentation, (84.79)
Anonymous Gift

SAGE System documentation, (84.38)
Gift of USAF Griffiss Air Force Base

Shakey the Robot, technical report, (84.40)
Gift of SRI International

Soft*Letter newsletter (complete set), (85.20)
*Gift of Soft*Letter*

Systems Development Corporation SAGE recruiting advertisements, Mental Abilities Test and SDC magazines, (84.58)
Gift of System Development Corporation

Travels in Computerland (signed by the author), (85.12)
Gift of Ben Schneider

UAIDE Computer Animation Committee 1969 Year-end Report, (85.18)
Gift of Carl Machover

Viatron ad Wall Street Journal 10/22/68 and As A Man Thinks by Thomas Watson, Sr., (84.62)
Gift of Charles Jortberg

Audio-Visual Material

Audio:

BBC "Chip Shop" audio cassette tape of interview with Oliver Strimpel, (85.4)
Gift of the British Broadcasting Corporation

Film and Video:

Automatic Teaching Project and 425/L Norad 16 mm films, (84.75)
Gift of Herb Willman

BIOMOD-2: 16mm film and photograph of Rand Tablet, (84.52)
Gift of The Rand Corporation

Boeing CAD/CAM film segments, (84.46)
Gift of Boeing Commercial Airplane Company

Computer Animation films (12 films), (84.86)
Gift of Ken Knowlton

Computer-assisted data Processing 16mm films, (four), (84.62)
Gift of Charles Jortberg

Design of Large Computers lecture by Seymour Cray on 3/4" video, (84.30)
Gift of Lawrence Livermore National Laboratory

Information Machine, Systems Technology, and the STP Story: 3 16mm films, (84.64)
Gift of Herb Willman

LEO: 16mm film of the LEO computer in England, (84.51)
Gift of Martin Campbell-Kelly

Live at 4 television coverage of The Computer Museum Opening on 11/13/84 (VHS videotape), (84.73)
Gift of Ian MacLennan

Rutherford Appleton Laboratory films (six), (84.33)
Gift of F.R.A. Hopgood

VHS videotapes of computers introduced at Boston Computer Society meetings (13 tapes), (85.9)
Anonymous Gift

VHS videotapes of computers introduced at Boston Computer Society meetings (4 tapes), (85.19)
Anonymous Gift

Photographs:

Ace to G-15 Lecture slides, (84.85)
Gift of Harry Huskey

Control Data Corporation photographs of 6600, 160, and 1604, (84.55)
Gift of Control Data Corporation

Dartmouth Timesharing photographs (5 photos), (84.90)
Gift of Dartmouth College

General Electric UNIVAC installation being discussed by Lillian Gilbreth and William Short, (84.60)
Gift of General Electric Company

IBM 7030, LARC, IBM CPC and Univac-1 photographs, (84.68)
Gift of Lawrence Livermore National Laboratory

LINC, Whirlwind, the Memory Test Computer, and TX-2 photographs, (84.71)
Gift of Lou Hirshberg

NEC photographs of Japanese computers, (84.53)
Gift of NEC Corporation

Printed circuit process photographs, (84.48)
Gift of National Bureau of Standards

RCA computer photographs, (84.56)
Gift of RCA Corporation

SAGE transparencies (20 positives), (84.38)
Gift of USAF Griffiss Air Force Base

SAGE, UNIVAC IBM 650 and Burroughs E-102 photographs, (84.34)
Purchased from DAVA Still Photography Depository

Teradyne photographs relating to the early days of that company (3 photos), (85.13)
Gift of Teradyne, Inc.

Historical Software

Digital Equipment Corporation, SpaceWar! program, (X607.85)
Gift of Digital Equipment Corporation

Gates, William, First BASIC written for the Altair, (X507.84)
Gift of William Gates and Microsoft Corporation

Software Arts, Inc., VisiCalc Beta Test Version 0.1, (X570.85)
Gift of Ben Rosen

Bill Gates' Teletype tape to input the BASIC interpreter for the Altair. When Harvard students Bill Gates and Paul Allen read about the Altair in the January *Popular Electronics*, they decided that they might make some money by creating an interpreter for BASIC on this new microcomputer. With the 8080 instruction manual and the Altair schematics, they produced the code, fitting in less than 4K of memory, within two months. They called Ed Roberts in Albuquerque and he said, that he'd buy from the first person that showed up with one. Paul Allen took the tape to MITS where he found only one machine that had 4K of memory. When he loaded it the teletype replied with "READY." Everyone at MITS was excited: they had never seen the machine do anything. Shortly thereafter Ed Roberts arranged to bring Bill Gates from Harvard to complete the implementation and Bill never returned to school.

The Allen-Gates Altair BASIC was listed in the MITS catalog like every-

thing else it sold, and each purchase earned the authors royalties. Nevertheless even before the first release a pirated version of Altair BASIC was in free-flowing circulation. Gates, then nineteen, wrote a letter to the *Altair Users' Newsletter* entitled an "Open Letter to Hobbyists." Gates noted that while he and Allen had received lots of good feedback about the interpreter, most of the people praising it hadn't bought it. Gates asked:

Why is this? As the majority of hobbyists must be aware, most of you steal your software. Hardware must be paid for, but software is something to share. Who cares if the people who worked on it get paid?

Eventually the widespread use of the BASIC interpreter was to help Gates. When other computer companies came on line and needed a BASIC, they went to Gates' company. He had created a de facto standard for microcomputers.



Blue Room Blues



Imagine you worked down a two-mile-long tunnel half a mile underground. There you were expected to sit for eight hours a day studying the blinking yellow screen of a spotless grey machine in a cement room devoid of decoration and lit only dimly by blue lights. Once you arrived you were not allowed to leave until the end of your shift, when you took a bus back to the barracks you called home, miles from civilization.

This environment was the workplace for radar operators of the Air Force's North Bay, Canada SAGE installation. Here operators monitored the atmosphere of the northern hemisphere, on the lookout for Russian bombers and missiles. "The Blue Room," as the radar center was called, was studiously designed to minimize the fatigue of the operators: the lighting was indirect blue fluorescent, to cut down on eye strain from the blinking yellow radar scopes; electric light-

ers and ash trays were built into the consoles; and the color of the equipment was a neutral battleship grey. To ensure efficiency, personnel were required to keep their consoles clear of clutter. In fact, the only extraneous object visible in the room was a large cardboard vampire bat attached to the ceiling, in deference to the room's cave-like qualities. However, as the Museum later discovered, this was not the only individual expression the operators allowed themselves.

When the equipment from the North Bay SAGE installation arrived at The Computer Museum, cleaning revealed interesting evidence of how the operators viewed their job. Each console has several knobs covering recessed switches. When these knobs were unscrewed the backs were found to be covered with graffiti written by the operators. The hidden messages ranged from the banal to the unpublishable. While ostensibly observing the

rigid regulations regarding a spotless work area, the operators still managed to express themselves clandestinely.

Here is a selection of the messages left by the operators hidden in their consoles:

"Put this back"
"HELP"
"Art Clark 1979"
"Bravo Crew is the pits"
"Look on the other knob"
"Superbowl XXII"
"Send the Cowboys to the superbowl"
"Don't you feel useless"
"\$25"
"Hi Jack"
"Help I'm trapped in here"
"No step take off Hey"
"1 May '79"
"I can't stand it"

Fall/Winter Program Series

Sundays at 4 pm

January 19

I. Bernard Cohen, Professor Emeritus, History of Science, Harvard University
Computing at Harvard in the Forties: The Story of Howard Aiken and the Incredible Harvard Mark I
Robert Campbell and Richard Bloch, programmers on the Harvard Mark I will join Professor Cohen for the question and answer session.

January 26

Dan Bricklin, co-inventor of micro-computer spreadsheets
VisiCalc—From Idea to Realization and Dissemination

February 2

Danny Hillis, Chief Engineer, Thinking Machines Inc & Builder of The Tinker Toy Computer
The Connection Machine: What Will a Computer with Thousands of Processors Do?

February 9

Carl Machover, Computer Graphics Pioneer
Behind the Screens: Computer Graphics From 1960 to the Year 2000

March 2

A.K. Dewdney, columnist Scientific American
Computer Recreations in Science: A PC-TREK into Uncharted Worlds

March 9

Peggy Brightman,
Artistic Director, CHOREO
Computer Dance

March 16

John Kemeny, Professor of Mathematics and Past President, Dartmouth College
BASIC: From Birth in the Sixties to Re-birth of a New True Basic for Contemporary Computing



February 13

ENIAC's Fortieth Birthday Party
On February 13th 1946, at 10:30 AM the ENIAC was first switched on. This event signalled the birth of the electronic digital computer.

In celebration of this very special occasion, J. Prespert Eckert, Chief Engineer of ENIAC and co-inventor with the late John Mauchly, will present a lecture. The official birthday party will follow. . . . Watch for your invitation in the mail.

February 15-23

A Special Week of Computer Activities and Games For Children of All Ages
Call our talking computer for details:
423-6758

Friday March 14 at 7:30 pm

Computer Dance Performance by CHOREO
"Boston's Computer-Friendly Dance Company"—DANCE UMBRELLA
Members Admitted Free.

Thursdays at 7 pm

Film and Video Screenings

February 20th and February 27th

Computers in the Movies:
Two feature films that starred computers will be shown.

March 6

The Early Years of Computer-Generated Video: 1973 to 1983.

March 13

Current Computer-Generated Video and Animation:
The Best from the SIGGRAPH Video Shows of 1984 and 1985

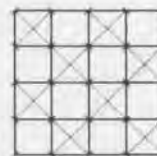

**For more information
call 423-6758.**

All programs will take place in The Computer Museum Auditorium. Admission to the programs is free for Computer Museum members, and free to others with admission to the Museum: \$4 for adults; \$3 for students and senior citizens. Reserved seats are available to members by sending \$2 per seat per program to Programs Coordinator, The Computer Museum, 300 Congress Street, Boston, MA 02210. Please make checks payable to The Computer Museum and clearly indicate which program(s) you plan to attend. Seats may also be reserved by paying \$2 at the door up to one half hour before the program begins.

Sponsored in part by grants from the Bank of Boston and Digital Equipment Corporation.

The Computer Museum

ECHO IV

In June, 1965 Jim Sutherland, a computer systems engineer with Westinghouse Electric Corporation, carted some scrap computer components from work to his home outside Pittsburgh. In less than a year he had constructed a working computer in his basement. The ECHO IV, short for Electronic Computer for Home Operation composed of four parts, caused quite a stir as it heralded the age of the home computer. Initially publicized in 1966 by the public relations department at Westinghouse, word of Sutherland's computer began to spread with the appearance of an article in Popular Mechanics and several television and radio interviews in 1968. The aspect of the ECHO IV

which the popular media harped upon most was its integration into Sutherland's home. The ECHO IV was a home computer in more than the sense that it occupied a room in his basement; it was connected to various terminals and systems throughout the house. Sutherland explained how one day he hoped to have the computer control many aspects of his household, such as the heating system, an alarm system, the garage door, the inventory of household items, and storage of the family's diet and budget information. At a point when there was great uncertainty as to how the computer boom would affect the average household, Sutherland's computer seemed a concrete indication of what the future might hold.

Sutherland's accomplishments were perceived to be so prophetic that he and his wife, Ruth, received many invitations to speak to Home Economic associations across the country on the computerized household of the future. Sutherland concentrated on a brief, and not very technical description of the ECHO IV and its potential uses, while his wife focused on what it was like to have a computer in the household. She allayed any fears that a computer might replace a housewife, stressing its advantages as a time saver and limitations resulting from only being able to follow instructions. She expressed excitement at the new challenge which programming the computer presented to her life. The Sutherlands' talks culminated in an address at the IEEE meeting in Pittsburgh on February 16, 1971.

The ECHO IV was contained in four units housing the memory, arithmetic, CPU, and input/output units respectively. Along with the four cabinets, a programmer's console including a printer, paper tape reader, and keyboard, was installed in the basement. In addition there was a control console in the kitchen, and digital clocks which the computer controlled throughout the house. Most of the components were finished in mahogany.

The ECHO IV was nearly a member of the Sutherland family. As Sutherland told Datamation in 1970, "The sleepless nights I've spent with that stupid machine. For a while there, I'd have given it to you. I'd hear it running in the middle of the night when it wasn't supposed to. So there I'd be, standing at the workbench in my pj's, groping for bugs."

Sutherland finally decided it was time to send this member of the family off to face the wide world on its own, and in 1984 he donated the ECHO IV to The Computer Museum.



Address Correction Requested

Non-Profit
Organization
U.S. Postage
PAID
Permit No. 110
Fitchburg, MA
01420

THE COMPUTER MUSEUM REPORT

VOLUME 15

SPRING 1986

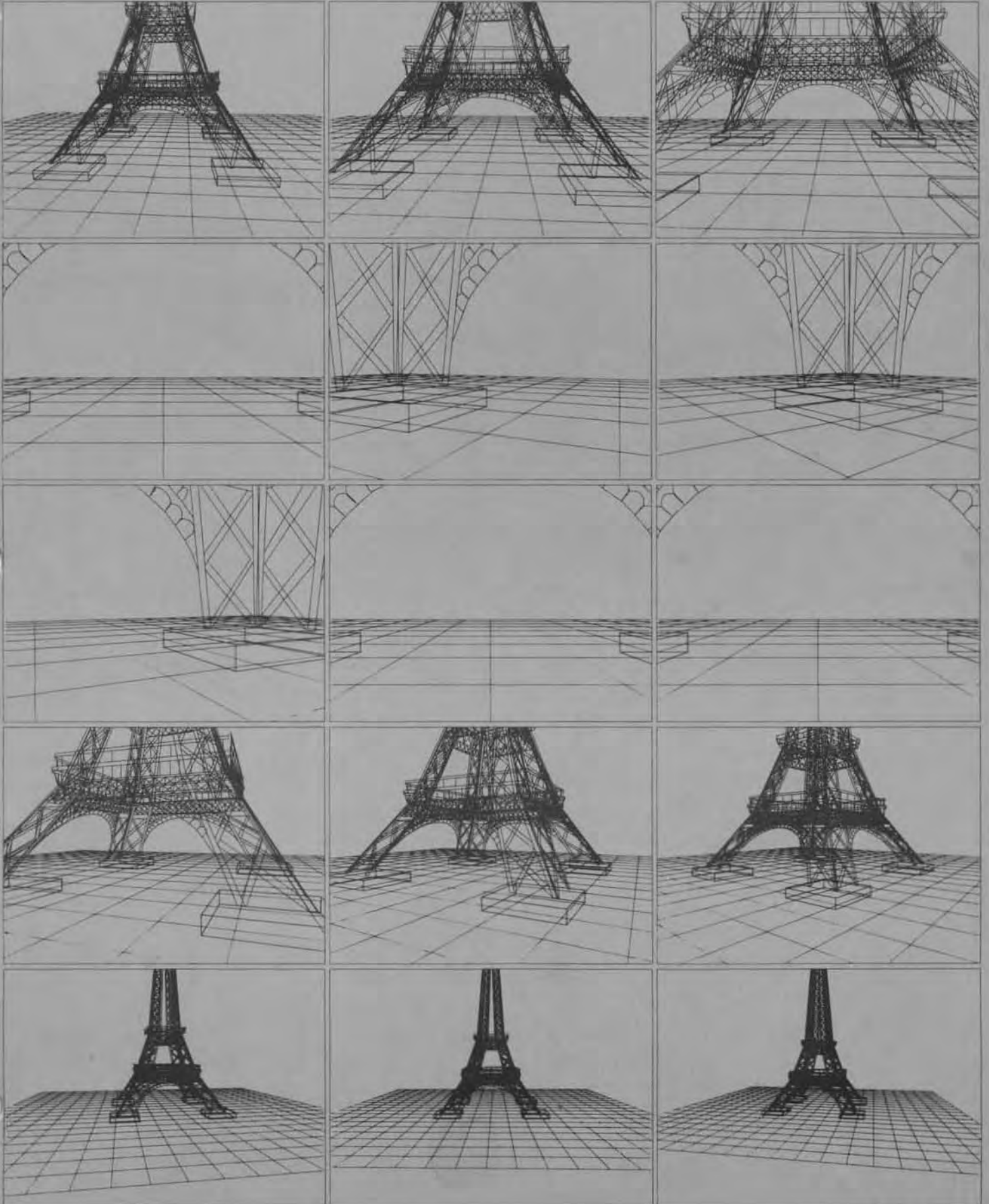

Board of Directors

John William Poduska, Sr.
Chairman and CEO
Belmont Computer, Inc.

Gwen Bell, President
The Computer Museum

Erich Bloch
National Science Foundation

David Donaldson
Ropes and Gray

Sydney Fernbach
Computer Consultant

C. Lester Hogan
Fairchild Camera and Instrument Corporation

Arthur Humphreys
ICL

Theodore G. Johnson

Mitchell Kapor
Lotus Development Corporation

August Klein
Masscomp

Dr. Koji Kobayashi
NEC Corporation

John Lacey
Control Data Corporation

Robert Lucky
AT&T Bell Laboratories

Patrick McGovern
CW Communications Inc.

James L. McKenney
Harvard Business School

Carver Mead
California Institute of Technology

William Millard
Computerland Corporation

Arthur P. Molella
The National Museum of American History
Smithsonian Institution

Brian Randall
University of Newcastle upon Tyne

Jonathan Rotenberg
The Boston Computer Society

Jean E. Sammet
International Business Machines

Edward A. Schwartz
Digital Equipment Corporation

An Wang
Wang Laboratories, Inc.

Maurice Wilkes
Digital Equipment Corporation

Trustees

Charles Bachman, C. Gordon Bell, Harvey D. Cragon, Robert Everett, Andrew Knowles, George Michael, Robert Noyce, Kenneth Olsen, Kitty Seltridge, Michael Spock, Erwin Tomash, Paul Tsongas

Executive Committee

David Donaldson, *Chairman*, Gwen Bell, Theodore Johnson, August Klein, Nicholas Pettinella, Jonathan Rotenberg, Ronald Smart, Oliver Strimpel, Michael Templeton

Contributing Members

Kenneth R. Adcock, J.D. Addeleston, Lawrence Adrian, Timothy Anderson, Roland Arndt, Isaac Auerbach, Richard G. Bahr, Art & Betty Bardige, Steve F. Barneby, John C. Barstow, G.C. Beldon, Jr., James Bell, Alfred M. Bertocchi, Dr. John H. Blankenship, Bontronics, Daniel S. Bricklin, Philip D. Brooke, Fred and Nancy Brooks, D.F. Brown, Gordon S. Brown, John and Ann Brown, Roger M. Buoy, James Burnett, Maria L. Carr, Charles and Virginia Casale, George Chamberlain, Richard J. Clayton, James F. Cody, Richard Corben, Howard E. Cox, Jr., Michael Cronin, Henry J. Crouse, Daniel Crowley, Curriculum Associates, David N. Cutler, Nick De Wolf, Peter De Wolf, Quentin De Wolf, James B. Deaderick, Delta Management, Lucien and Catherine Dimino, Ditarigiani Family, Phillip H. Dorn, Theodora Drapos, Ray Duncan, Joseph J. Eachus, Fred Ebeling, Dr. Richard Eckhouse, Tom Eggers, Dan L. Eisner, Lucian Endicott, Bob O. Evans, Robert A. Farmer, Geoffrey Feldman, Read T. Fleming, Larry Forte, Clark Frazier, Alan E. Frisbie, Edward A. Feustal, Lorrin Gale, Kevin A. Galvin, Branko J. Gerovac, David Goodman, William Graustein, Stephen Gross, Dr. Roberto Guatelli, Jerrier A. Haddad, Tom & Rosemarie Hall, Michael P. Halter, J. Scott Hamilton, Sheryl Handler, Frank E. Heart, Daniel and Nancy Heff, William Helm, Jr., Margaret Herrick, Thomas L. Hohmann, Nancy S. Horie, M. Ernest Huber, Charles A. Jortberg, Richard M. Karoff, Lawrence J. Kilgallen, Martin Kirkpatrick, Bryan S. Kocher, Neal Koss, Alan Kotok, Marian Kowalski, Stanley Kugell, Theodore Kuklinski, Raymond Kurzweil, Robert Laman, Glen C. Langdon, Jr., Curt Larock, Andrew Lavien, Tsvi Lavi, John R. Levine, Michael Levitt, John V. Levy, George Logemann, Carl D. Lowenstein, John Lowry, Lube, Inc., Arthur Luehrmann, Carl Machover, Julius L. Marcus, Andrew H. Mason, Joe W. Matthews, Robert Mayer, Jr., Richard McCluskey, Tron McConnell, F. Warren McFarlan, Jim McIntosh, Robert W. McKnight, William and Vesta McLean, Todd Medlock, R.W. Meister, Richard G. Mills, Charles Minter, Allen Moulton, Dr. J. Craig Mudge, Carol E. Muratore, Dr. and Mrs. Isaac R. Nassi, Cynthia L. Nelson, Stewart Nelson, Joseph Nestor, Joseph M. Newcomer, Tim K. Nguyen, Bernard J. Nordmann, James N. O'Boyle, Jr., Anthony G. Oettinger, Lawrence & Pauline Oliva, John E. Parker, Kenneth D. Patterson, James and Martha Patton, Nicholas and Nancy Pettinella, James H. Philip, Linda J. Phillips, Paul R. Pierce, Juan A. Pineda, James A. Pitts, Andrew Plescia, J. Eric Pollack, James N. Porter, David Potter, Robert C. Probasco, Audret Reith, C. Mike Riggle, Linda and David Rodgers, Ann and Robert Roe-Hater, David C. Roh, Michael Rooney, Daniel Rose, David Rose, Paul Rosenbaum, Jonathan Rotenberg, Martin S. Roth, Thomas S. Roy, II, Eugene Rudolphe, Howard Salwen, Michael J. Samek, F. Grant Saviers, Andrew Scott, Aaron and Ruth Seidman, Oliver and Kitty Seltridge, W. Lee Shevel, John J. Shields, III, Diane J. Skiba, Ph.D., Allen G. Sneider, John R. Spencer, Max J. Steinmann, William M. Steul, J. Michael Storie, Charles A. Stott, David Tarabar, John V. Terrey, William R. Thompson, Warren G. Tisdale, Michael G. Tomasic, Sherry Turkle, G. Michael Uhler, Noah E. VanDenburgh, Thomas Vaughn, Christian Walker, Allan L. Wallack, Joseph B. Walters, Jr., Thomas E. Welmers, Bob Whelan, John D. Wick, Hugh M. Wilkinson, III, Kevin Willoughby, Andrew Wilson, T.J. Wojcik, Jr., D.L. Wyse, Jeffrey N. Zack

Corporate Donors

Benefactor—\$10,000 or more

AFIPS, Inc.*
American Express Foundation
American Telephone & Telegraph Co.*
Apollo Computer, Inc.*
Bank of America*
The Boston Globe*
ComputerLand*
Control Data Corporation*
Data General Corporation*
Digital Equipment Corporation*
Hewlett-Packard
Honeywell Information Systems
International Data Group*
International Business Machines, Inc.
The MITRE Corporation*
NEC Corporation*
Sanders Associates
The Travelers Companies
Wang Laboratories, Inc.*

Patron—\$3,000

Adage, Inc.
Addison-Wesley
Arthur D. Little, Inc.
Bitstream
Boris Color Lab, Inc.*
Burroughs Corporation
Coopers & Lybrand
DECUS*
Draper Laboratories*
Gaston Snow & Ely Bartlett*
General Computer Co.
The Honeywell Foundation
IEEE
Index Systems*
Intel Corporation
Liberty Mutual Insurance Co.
Arthur D. Little, Inc.
Lotus Development Corporation
Major Computer, Inc.
MASSCOMP
McGraw-Hill, Inc.
Microsource Financial
NEC Systems Laboratory, Inc.
Nolan, Norton & Company, Inc.*
Prime Computer Corporation
The Prudential Insurance Company
Regis McKenna, Inc.*
Ropes & Gray
SHARE, Inc.
Software Results Corporation*
Stratus Computer, Inc.*
Symbolics, Inc.
3Com Corporation*
United Technology-Mostek
/u/s/ group
Venture Founders Corporation

Contributor—\$1,000

Access Technology
Analog Devices, Inc.
American Management Systems*
Arthur Andersen, Inc.
Autographix
Bank of Boston
Bolt Beranek & Newman
Boston Safe Deposit & Trust Company
BusinessLand
Citicorp (USA), Inc.
Cullinane Foundation
Dane, Falb, Stone & Co.
Deloitte Haskins & Sells
E.J. DuPont DeNemours & Co.
Foley Hoag & Elliot
Ford Motor Company*
General Systems Group, Inc.*
Gould, Inc.
Greylock
GTE Data Service, Inc.
GTE Laboratories, Inc.
Houghton Mifflin Company*
Hyams Trust
International Computer Ltd.*
Investment Orange Nassau, Inc.
LTX Corporation
Manufacturers Hanover Trust
Meditech*
Mentor Graphics
MICOM-Interlan, Inc.
Micro Control Systems
Microsoft*
New York Air*
Pathway Design, Inc.
PC Magazine
Peat, Marwick, Mitchell & Co.
Pell, Rudman, Inc.
Pencept, Inc.
Polase-Clancy, Inc.
Shawmut Corporation
Standard Oil Corporation
Teradyne
XRE Corporation
ZBR Publications, Inc.

* Contributed to the Capital Campaign

Core Members

Harlan E. and Lois Anderson
Charles and Constance Bachman
C. Gordon Bell
Erich and Renee Bloch
Henry Burkhardt III
R. Steve Chehey
Robert C. and Eleanor W. Chinn
Robert G. Claussen
William Congleton
Alex d'Arbeloff
Arnaud de Vitry
David Donaldson
Douglas Drane
Robert Everett
Kenneth G. Fisher
Jay W. Forrester
Gardner Hendrie
Winston R. Hindle, Jr.
Peter Hirschberg
Theodore G. and Ruth T. Johnson
John Allen Jones
Mitchell Kapor
Allan Kent
Jack S. Kilby
August Klein
Andrew C. Knowles, III
David J.A. Koogler
Edward and Debbie Kramer
John W. and Edna W. Lacey
Ralph and Linda Linsalata
John Norris Maguire
Richard D. Mallery
Thomas Marill
Daniel D. McCracken
James L. McKenney
Thomas and Elizabeth McWilliams
Carver Mead
Robert M. Metcalfe
Allen Michels
Robert M. Morrill
David and Pat Nelson
Robert Noyce
Kenneth Olsen
Stanley C. Olsen
John L. Payne
Edward G. Perkins
John William Poduska
Robert M. Price
Fontaine K. Richardson
Douglas Ross
Jean E. Sammet
Paul and Catherine Severino
Alan F. Shugart
Richard L. Sites
Ronald G. Smart
Charles E. Sporcik
Ivan and Maria Sutherland
Del Thordike and Steve Teicher
Erwin Tomash
Jean De Valpine
Charles P. Waite
Stephen L. Watson
Harvey W. Wiggins, Jr.
William Wolfson



Contents

- 1 The President's Letter
Dr. Gwen Bell
- 2 The Museum Mouseathon
- 6 From the First 16-bit Mini to
Fault Tolerant Computers
Gardner Hendrie
- 10 Classic Film Clips Showing
Computing from 1920 to 1980
- 14 A Real-Time Event
- 16 Computer Graphics Image
Contest
- 17 Spring Program Series
Calendar

Cover

Effie, by Keith Waters, first student place in the CalComp International Computer Art Competition. Winners on display at the Museum February 1-March 30 1986.

The Computer Museum

The Computer Museum is a non-profit 501(c)3 foundation that chronicles the evolution of information processing through exhibitions, archives, publications, research, and programs.

Museum Hours: The Museum hours are 10 AM-5 PM, Tuesday, Wednesday, Saturday, and Sunday and 10 AM-9 PM, Thursday and Friday. It is closed Mondays, Christmas, New Years, and Thanksgiving.

Membership: All members receive a membership card, free subscription to The Computer Museum Report, a 10% discount on merchandise from The Computer Museum Store, free admission and invitations to Museum previews. For more information, contact Membership Coordinator at The Computer Museum, 300 Congress Street, Boston, MA 02210, (617) 426-2800.

Staff

Dr. Gwen Bell, President

Michael Templeton, Director

Dr. Oliver Strimpel,
Associate Director and Curator
Kurt Levitan, Exhibit Specialist; William Wisheart,
Registrar; Terry Mullins, Education Coordinator;
Gregory Schroeder, Reservationist; Gregory
Welch, Research Assistant.

Mark Hunt, Marketing Director
Louise Domenitz, Public Relations Manager;
Jessica Pollard, Communications Assistant;
Kathleen Keough, Functions Coordinator.

Michael Oleksiw, Development Director
Anne Jenckes, Development Assistant;
Scott Reilly, Membership Coordinator;
Linda Clingan, Museum Benefits Coordinator.

Ma Radding, Business Manager
Cohen, Store Manager; Steven Klinke,
Assistant Store Manager; Stephanie Finley,
Assistant to the Store Manager; Nancy Dattero,
Office Manager; Deborah Goudreau, Business
Office Assistant.

Germain DRK
Public Relations Advisors

Benson Clemons Design

The President's Letter

Dear Members,

The Museum has now been open for one year. A year in which we have learned a great deal about our potential and our members' interests. We hope to put that knowledge to work in order to serve you better: putting on a wide variety of programs; scheduling special temporary exhibitions; holding innovative fund-raisers; and offering new products in our store that let you "have a bit of the Museum" for yourself, wherever you are.

Our program series, founded to serve our membership and attract the attention of the public, has also diversified. For the Fourth of July we put on our first Computer Animation Festival and had one of our best attended afternoons ever. Our winter program series features a Thursday evening film series. A simple talk on "micromice" escalated into the first Boston Mouseathon, described by Oliver Strimpel in the first article. Museum founder Alan Frisbie from Los Angeles wandered in for a visit and ended up spending the whole day! The event turned out to be a real "crowd please" and boost for micromouseketeering. The February Kids Computer Fair brought widespread participation from schools, user groups, educational software developers and Museum enthusiasts.

We also "fell into" doing temporary exhibitions with a show of the original artwork for BYTE magazine covers by artist Robert Tinney. This was so well received that we kept the show on display in the space near the auditorium until we could fill it with something else. It came down in mid-January in time for the January 31st opening of "The Electronic Paintbrush." The cover of this report features one of the works from this exhibition. The result of a competition sponsored by CalComp in honor of their 25th anniversary, the exhibition was first displayed at the California Museum of Science and Industry. It will be here until March 31. "Colors of Chaos," an extraordinary set of computer generated fractal images, will be on view from April 10th through June 15th. The space works for such exhibits and we welcome your suggestions for others that might be appropriate for the Museum to show.

Before we moved, the annual benefit was established. Now our fund-raising efforts have also grown and diversified. The Marlboro "yard sale" was transformed into an even more successful "attic sale" appealing to both collectors and tinkerers. In December, the Museum held "A Real-Time Event"—a truly unique fund-raiser as described later in this report issue. February's Fortieth Birthday Party for ENIAC was inspired by member Annie Roe-Hafer and heavily supported by Bitstream, Inc. a corporate member. June 8th will bring our annual gala with the Board of Directors and another chance to hear from one of them on the state of computing. Each of these events are fund-raisers and fun-raisers that appeal to different parts of the Museum's audience, and allow a great deal of interaction between members and the staff.

Finally, we have produced a videotaped version of the "See It Then" theater at the Museum. This film has gotten such good reviews for providing a quick and fun overview of the history of computing that we had to make it available, especially for everyone who teaches and can't bring their classes to the Museum. If a picture is worth 1,000 words, then this videotape is worth a 100,000 word reading assignment.

The suggestion box is open. Most of these ideas came to us from members and then they grew. In reviewing this list, it's clear to me that the Museum has an important membership. We're here because you are too.

Gwen Bell

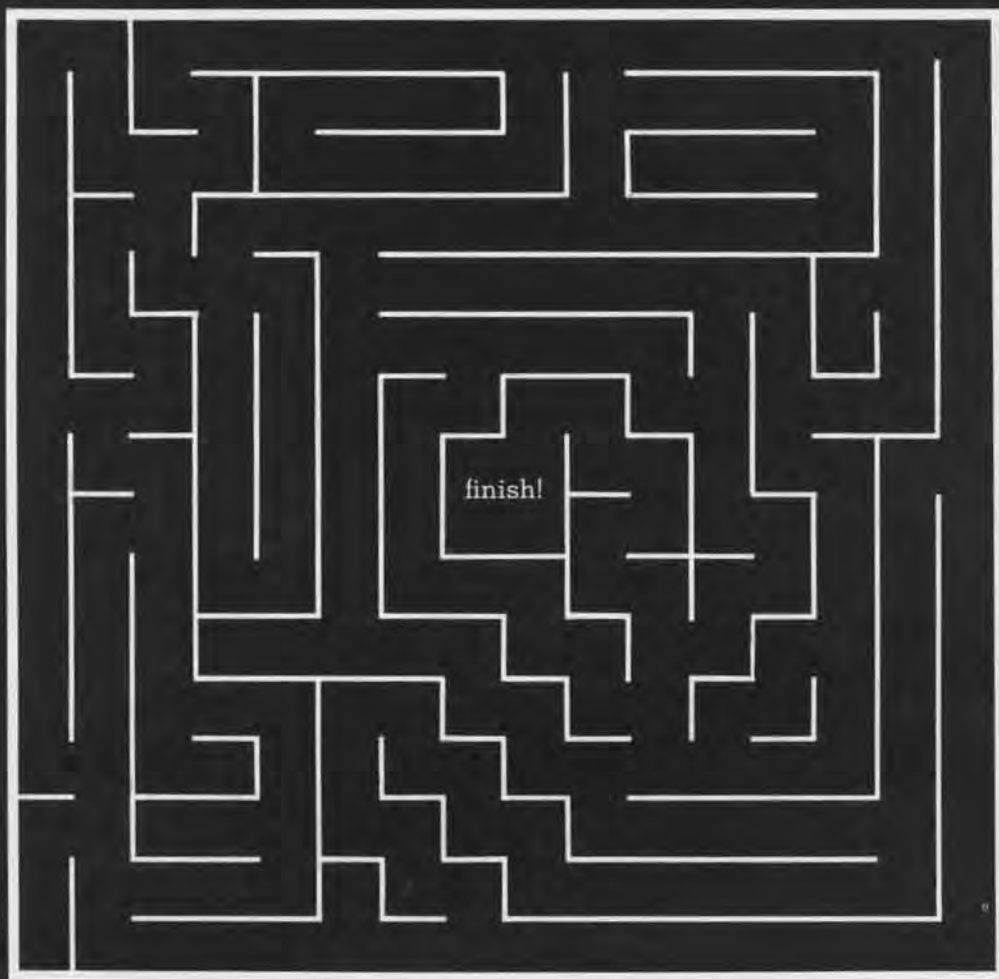

start

finish!

Maze layout used in Mouseathon finals

The maze was selected to have a number of routes to the center which had similar length, but a varying number of corners. This offered a subtle test of the mouse's strategy in choosing between rapid cornering and acceleration down a straight. Note also the zig-zagging required in the final approach.

The maze consists of 16×16 squares, each 18cm on a side. The walls are 12mm thick, 5cm high, painted white with red tops. The target is the center, and the start is at the 'bottom left' corner. The running surface is chipboard, painted black with non-gloss emulsion paint. The walls are composed of removable segments connecting posts at the corners of the squares, so that mazes can readily be changed.

What is a Micromouse?

A micromouse is a mobile sensing robot that can negotiate a maze. The contest rules state that the mouse must be self-contained, cannot use combustion as an energy source and cannot leave part of its body behind while in the maze. It cannot jump over, climb, scratch, damage or destroy the maze walls. It must be less than 25cm in both length and width; there is no height restriction.

Most mice use active infrared sensors to locate the walls. A pulse of 1000 nanometer infrared is shone downwards from a vane that extends over the walls adjacent to the mouse. The red top of a wall sends back a strong reflection, while the black floor does not. Some mice, notably the Finnish team have used acoustic sensors. The Noriko mice used the position gyroscope as an additional

sensing device to preserve accurate control during rapid cornering.

The most popular microprocessor used to control the mice is the Z80. In 1981, Alan Dibley went so far as to saw off the keyboard of a Sinclair ZX80 computer and use it intact to control his Euromicro finalist, 'Thezeus'. Indeed, the 'Thezeus' series were largely built out of bits of junk—piano wire, rubber bands (for tires), and parts from radio-controlled models.

Championship Rules (similar to rules applied at the Museum Mouseathon)

Each mouse has 15 minutes in the maze. It can make as many runs as it likes, and the fastest 'inward' run from the start to the center is recorded. If a mouse 'gets into trouble', it must be taken out of the maze and restarted at the beginning. No information on the maze can be fed to the micromouse. For full rules see IEEE Micro, Vol 4 No 6, (1984) pg 86; for information about future contests, contact Micromouse Committee, IEEE Computer Society, 1730 Massachusetts Avenue NW, Washington, DC 20036.

The Museum Mouseathon

Origins

It all began with a 1977 announcement in *Spectrum* magazine that the time was ripe for microprocessors to put on wheels for a self-controlled ride. The challenge was to build a mouse that could find its way to the heart of a maze, remember it, and then run the course as fast as possible. The IEEE Computer Society formalized the competition, specifying maze and mouse dimensions, and trials took place throughout 1978 with a final race at the National Computer Conference in 1979. The winner was the only mouse among the 24 entrants that made it to the finish! The rest of the entrants got stuck or confused, or just failed to start. But the contest looked like fun. These small mobile robots require hardware for propulsion, steering, guidance, wall and track sensing and software for mapping and strategy. The fixed set of rules constrains the problem and the contest provides a quantitative measure of progress.

International Micromouse Racing

The idea has taken off in Europe and Japan. Under the impetus of Dr. John Billingsley, mice from the UK, Finland, West Germany, Switzerland have competed in European championships held every year since 1980.

Since the first Japanese micromouse contest in 1980, the Japan Micromouse Association has grown to 800 members spread throughout the country. The association has a permanent board of directors, consisting of senior academics, industry executives and officials of the Japan Science Foundation. A bimonthly magazine 'Mouse' is published, covering micromouse events worldwide.

In 1985 the Japan Micromouse Association held a World Micromouse Contest coinciding with the World Expo in Tsukuba City, Japan. With support from the Japan Science Foundation and NAMCO Ltd., the Japan Micromouse Association invited teams from Britain, Finland, Germany, South Korea and the United States to compete. It soon became clear that the visiting mice were no match for the Japanese entrants. The first five prizes all went to mice from a single Japanese microcomputer club—the Fukuyama Club, from Hiroshima Prefecture.

Micromice in the US

Although the idea originated in the United States in 1977, it has not caught on. In 1984, in an effort to rekindle US interest, the Japan Micromouse Association presented the IEEE Computer Society with an official micromouse maze for use in the US contest where participants in the world contest would be selected. Mappy, the official mouse of the Japan Micromouse Association was loaned together with the maze. In the Spring of 1985, The Computer Museum and the IEEE Computer Society agreed to site the maze at the Museum, develop a micromouse exhibit and hold a special inaugural event.

The Museum Event

Dr. Peter Rony of the IEEE Computer Society and Dr. John Billingsley from Portsmouth, England kicked off the Museum's race week with a lecture/demonstration on Sunday, November 17. Dr. Billingsley demonstrated three mice he had brought from England.

A group from The Japan Science Foundation, NAMCO and the Fukuyama Club were also invited. Mr. Hirofumi Tashiro, Secretary General of the Japan Micromouse Association and Manager of the Director's Office at NAMCO Ltd. led the group. Three

members of the Fukuyama club came: Mr. Masanori Nomura, a trained veterinarian, Mr. Masaru Idani, system technical researcher for Japan System Design Co. Ltd. and Mr. Eiichi Fujiwara. The IEEE Computer Society arranged for Mr. Key Kobayashi, an interpreter to attend.

The Inaugural Run

John Billingsley's three English mice rapidly cleared customs at Logan airport in Boston where they are used to seeing weird electronic contraptions. 'Thumper', the 1981 European champion by David Woodfield, runs on four wheels and turns by swivelling his wheels, not by rotating the whole body. His large and heavy frame tends to thump the walls, hence the name. His ability to talk, apart from being very funny, is used for diagnosis. 'T6', the latest in a series of 'Thezeus' mice by Alan Dibley, and 'Enterprise', the 1984 European Champion by David Woodfield are both three-wheeled mice with DC motors to provide propulsion on the back wheels and an optical distance counter on the steered front wheel. All three use the Z80 microprocessor.

Though delicate, the mice survived the journey intact, and they were

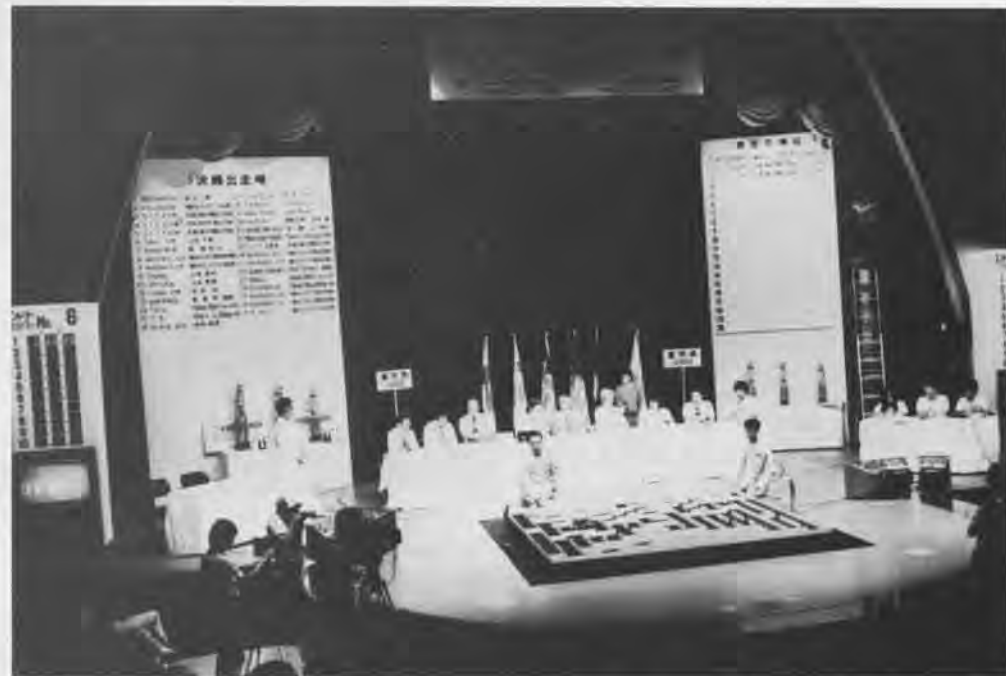

The 1985 World Micromouse Contest at Tsukuba. Fifteen contestants from 5 overseas countries and 120 from Japan competed.

checked out on a trial maze. It soon became apparent that Thumper was most confused, and T6 was steering straight into the walls. Preferring not to attribute this performance to jet lag, we suspected that the maze itself was not giving the infrared signature required by the mice. The mice detect the walls by using active infrared sensors that stick out above the walls of the maze and look down. The tops of the walls are meant to be reflective in infrared (around one micron wavelength) and the black floor of the maze is meant to absorb infrared. However, the floor of the maze, though black, looked rather shiny in the infrared, so after obtaining permission from the IEEE Computer Society, we covered the maze floor with a thick coat of the mattest black emulsion we could find. Thumper and T6 still occasionally went 'blind', so we began to suspect the walls. Using Thumper as an infrared reflectometer, we found that the dull red plastic layer that covered the tops of the walls was actually a very poor reflector of infrared. So we covered all the wall tops with strips of highly infrared reflective red sticky paper, and this solved the problem.

At the start of the Sunday lecture, Peter Rony spoke on behalf of the IEEE Computer Society, presenting the Museum with the loan of the official maze, and encouraging future mouse-building activities in the US. John Billingsley then described the history of European micromouse events and demonstrated the three English mice. Thumper, though slow and lumbering, makes up for it by his speech, saying "I will find the shortest route" as he pulls off from the start. Apparently at random, he sings out with a repertoire consisting of remarks such as 'I hope there are no cats in here', 'my work is never done' and 'I could do with a rest—my wheels are killing me!' When comparing Thumper to the later mice, it's hard to believe that he is more than all talk and no action—he was actually the European champion in 1981.

Enterprise and T6 learn the maze after relatively little exploration and take advantage of the straight passages with bursts of acceleration.

The Mouseathon

After 21 hours in the air, the Japanese participants arrived late on the Thursday before the Saturday event. Refreshed the following morning, they unpacked their mice—all members of the 'Noriko' series. The older X1 and X2 performed well at once, but X3 and X4 seemed a bit worse off for the long

After a burst of speed down a straight, T6 brakes just in time to round a corner.



Mr. Tashiro watches Mappy at the maze's start NAMCO, a large manufacturer of computerised games and toys, built 10 identical show mice in 1981 to promote interest in micromouse racing. Modelled after a popular Japanese cartoon character, Mappy plays the role of a mouse policeman, scouring every alleyway of the maze to find a troublesome stray cat. With siren

blaring and baton waving, he bears down on the center of the maze where he spins around to burst a balloon with a pin mounted on his tail. Then he races back to the starting square, sirens still blaring and lights flashing, and shouts "I got 'em!" in Japanese.

Mappy will be demonstrated regularly at the Museum while on loan from NAMCO.

travel, and needed some attention from the chief engineer, Mr. Idani.

An enthusiastic crowd of over 400 people showed up for the event. Throughout the morning and early afternoon time-trials were held. Each mouse had fifteen minutes in which to make its best run to the center (see rules box). All mice completed the maze, except for Noriko X4 which never really got going. Noriko X1 came in fastest, at 14.8 seconds in contrast to Thumper who managed to talk his way through the maze in 3 minutes. Mappy performed a couple of his noisy runs, greatly entertaining the audience.

The race's judges then took their places: Susan Rosenbaum, governing body member of the IEEE Computer Society and volunteer in charge of US micromouse activities, affectionately known as 'micromom', Gwen Bell, the Museum's president, Hirofumi Tashiro and John Billingsley.

The maze was changed to make sure that memories of the time-trial maze could not give any mouse an unfair advantage and the race then began with the mice competing in the order in which they qualified.

Noriko X4 still failed to wake up, but X3 completed a run in just over 13 seconds. Next, Thumper talked his way into the corners, so badly out of alignment that he had to be retired. T6, which must be the quietest mouse ever built, came in at 37.2 seconds. Enterprise performed reliably again, never slipping or needing any kind of adjustment. But his time of 28.1 seconds proved no match for the Japanese.

Now the two fastest Noriko's battled it out. Although the Noriko mice carry out a lot of apparently redundant maze exploration at the outset, they make up for it with speed and

cornering agility once they find the shortest routes. It was breathtaking to watch the slalom as they swung around the final zig-zags towards the finish. Several times the Noriko's got stuck a hair's breadth from the finish and had to be carried back to the start. In the end, powered by a freshly inserted heavy duty Nicad battery pack, X1 made a lightning fast run of only 10.85 seconds, just over half a second faster than X2's best run of 11.55 seconds.

Gwen Bell awarded the prizes—silicon wafer pendants, hung around the necks of the human participants, not the mice.

The Future

The Museum will hold more races when new mice come forward to challenge the Japanese and Europeans. There are encouraging signs—several groups took notes at the races, saying they planned to build micromice with better maze-solving strategies. For

those who want to try their hand at the software side of micromouse racing, NAMCO Ltd. makes a kit that can be purchased via the IEEE Computer Society.

John Billingsley is now promoting robot ping-pong, or 'robot'. Contestants mount their players at either end of a special table with controlled lighting and a mechanism to serve the ball. The players essentially consist of a bat fixed to an x-y plotter mounted vertically together with a vision system.

The Museum plans to collect micromice and provide a venue for future international sporting events!

IEEE Spectrum © 1985. Photographer: Malcolm Hewitt



After the award giving, from left to right: Eiichi Fujiwara, Masanori Nomura, John Billingsley, Oliver Strimpel, Masaru Idani. Mr. Idani and Mr. Fujiwara hold 1st and 3rd place winners, Norikos X1 and X3. The Noriko series employs a 'wheelchair' drive: two wheels have drive motors and steering is accomplished by driving them at different speeds. Fore and aft are wheels, castors or skids to provide stability. The newer Noriko's are DC motor driven, the older ones using stepper motors. A home-made position

gyroscope with its axis mounted horizontally gives the mouse an accurate measure of how much it has turned, a critical piece of information when the wheels are liable to skid during very rapid cornering. These mice also have easily inserted ROMs, used to give the mouse different strategies, depending on the maze. ROM-swapping and tweaking of potentiometers is not allowed in European contests where a more rigorous criterion of micromouse self-sufficiency is applied.



Judges Susan Rosenbaum (left), Gwen Bell (center), and Hirofumi Tashiro with John Billingsley commentating.

Throughout my career as a computer designer, I have set out on explorations into the unknown. Over and over again I undertook the design of new computers without the foggiest idea of how to do it. Over the last twenty years, I was involved with three different machines at three different companies. In what follows, I have corrected all the dollar amounts for inflation so that direct comparisons can be made.

A Personal Odyssey

From the First 16-bit Mini to Fault Tolerant Computers

Gardner Hendrie

1964: The First 16-bit Mini

In 1964, three companies competed in the mini-computer market, even though the name had not yet been invented and they were called real-time control computers. DEC did \$37 million in business; Computer Controls Corporation (CCC) \$50 million; and Scientific Data Systems (SDS) \$67 million business. SDS which grew to \$134 million in the next year, was clearly the successful company of the three. Then in the late sixties, SDS was bought by Xerox for about a billion dollars and became SDX. In the sixties, Xerox disbanded this fairly expensive experiment. In 1965, CCC was purchased by Honeywell, surviving until the early seventies when it disappeared into the larger organization.

In 1964, DEC was selling the PDP-5, the precursor of the PDP-8, for \$95,000. CCC was selling the DDP24, and SDS the SDS 910 and 920, each for about \$300,000. The machines had 8K bytes of memory and the basic i/o device was the flexowriter, the precursor of the ASR 33 teletype which provided a keyboard, a printer, and a paper tape puncher and reader. Software existed but was not elegant. The operating systems would run on 4K words of memory and on a FORTRAN compiler with 8K words. Back-up storage was done on magnetic drums that ranged between 32,000 and a million bytes.

At that time, I had been earning a living for ten years as an engineer. My inflation adjusted salary was \$65,000. If you look at salaries today they are equivalent. A VW bug cost just over \$5,000. A lot of things stay the same forever, adjusted for inflation.

I had designed an industrial control computer for a division of RCA that ceased to exist two years after the computer was built. When I designed that machine, I had never designed or even worked on the design of a digital computer before, nor had I taken a course in digital computers. I did have an elementary course where I learned plug board programming on an old Burroughs machine, so I had some vague idea of the basic principles of computers. The experience was my education. The computer seems absolutely prehistoric by today's standards. It took 56 microseconds to add two 24-bit numbers and cost roughly half a million dollars. NASA used this machine for checking out the main Saturn booster stage on the Apollo missions.

Lowell Bensky, whom I had worked for at RCA when I was out of college, asked me to join CCC. The VP of marketing at CCC believed that if we could build a \$75,000 computer to go along with the \$300,000 DDP24, a lot more machines would be sold. I left Foxboro to build that machine for CCC. At the time, the competition was the PDP-5 and CDC's 160. In my view, the CDC 160 with its short word length, a basic instruction that could not address all of memory, and relative, indirect and chained indirect addressing, pioneered the architectural concepts that made the minicomputer feasible. It was a commercialization of Seymour Cray's first machine at CDC, The Little Character, that can be seen at the Museum and is featured in "The End Bit" of this Report.

CCC was in a good technological position to produce a competitive com-

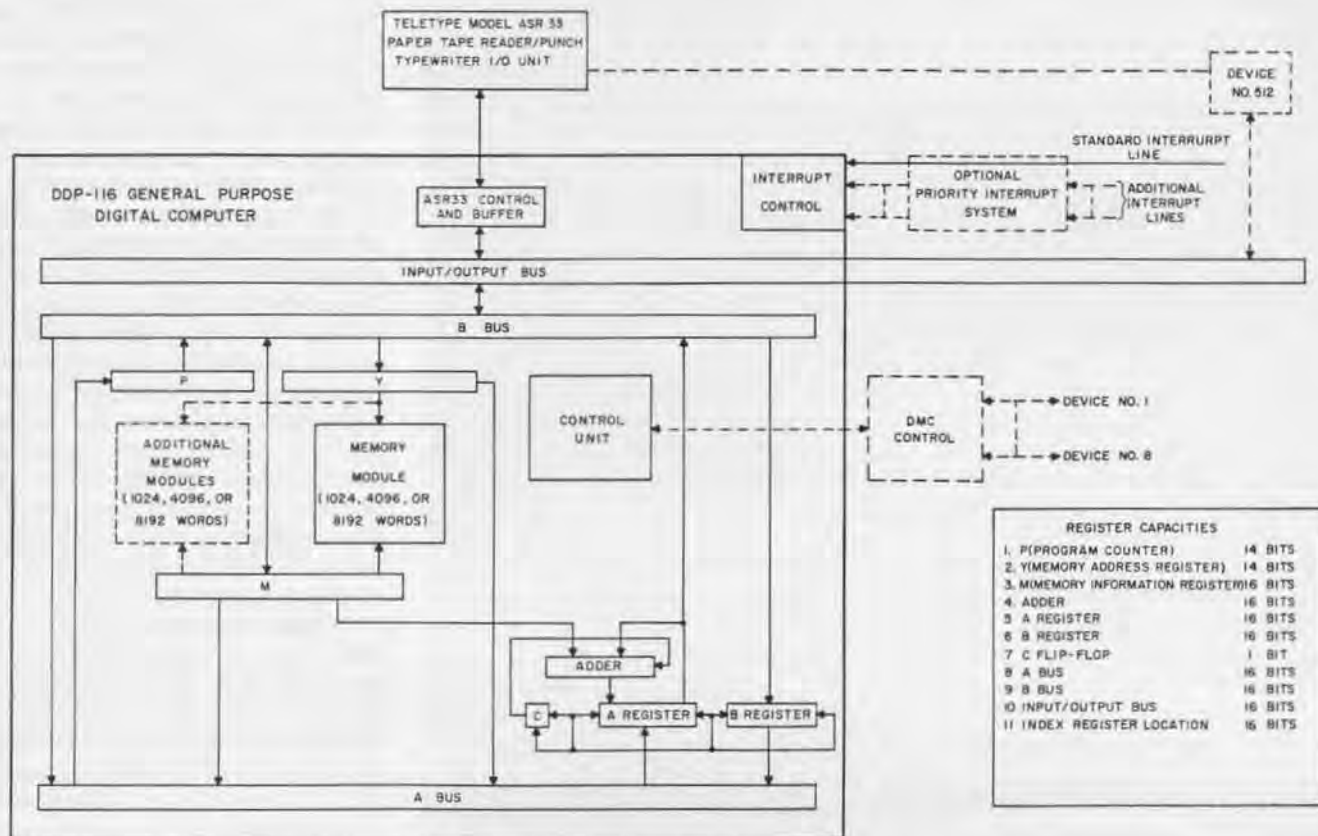

DDP-116 General Purpose Computer, Simplified Block Diagram

puter. It manufactured a set of 5 megahertz logic cards, each with a couple of flipflops of four or five and gates. Customers bought a card cage, plugged the cards in and then wire wrapped all of the cards together and interconnected them on the back. The company also had a memory division that built one of the more advanced devices for the time with a 1.7 microsecond cycle time. DEC's PDP-5 had a six microsecond cycle time memory and CCC's DDP 24 had a five microsecond cycle time memory. The question was—what should one build with this fast memory and circuit technology?

I became infatuated with the idea of building a fast, short-word length machine. 12 bits looked a little short. 14 bits looked just about right. It gave you enough code for a reasonable instruction set and addressing range. I didn't want to make it any longer than I had to because it would make the machine more expensive. In those days, the computer and its memory were the dominant costs not the i/o equipment. After a couple of weeks at CCC, I had an outline of the specifications.

Then, on April 26th, 1964, three weeks after I joined CCC, the bomb-

shell hit: IBM announced the 360 and declared that the six-bit character was no longer going to be a standard for storing alphanumeric data. Instead, it would be an eight-bit unit called the byte. It didn't take much to say, "I'll bet if we increase the cost of the processor ten percent or so and lengthen the word to 16 bits we'll make up for the cost in the market appeal of a machine that can store two eight-bit bytes on the new standard just set by IBM."

By August 1964, the specs had been completed on the DDP-116. In October the machine was announced and the first shipment was in March of 1965. Only 200 were ever sold.

In 1965, CCC announced a new logic family called the Micropac using integrated circuits. These were the first commercially available integrated circuits that were designed by CCC and subcontracted to semiconductor manufacturers. The most reliable manufacturer for these flat packs was Westinghouse. CCC had also by this time designed a less than one microsecond cycle time memory.

When the 116 was shipped in March, 1965, we immediately started to work on a low cost version, the 416, and

a higher cost version, the 516. Shipped in September, 1966, the 516 had a .96 microsecond cycle time and sold for \$82,000. The 416 built with a hobbled 116 instruction set was supposed to cost \$5,000 and sell in large quantities. While it was estimated that only 130 of the more expensive 516s would be sold. Very few 416s were ever bought, but over 2000 516s. Then a 316, lower-cost, slower machine was built to compete with DEC's lower cost 12-bit machines that seemed to be flooding the world.

After CCC was bought by Honeywell a process of decay had set in. I stayed at Honeywell working as an engineering manager and then as a product manager in marketing. Prime was formed to step into the vacuum that Honeywell left in getting out of the minicomputer market. Every machine up through the Prime 750 was object code compatible with the DDP-116 and 516.

1973: The Advent of Microprocessors

In 1973, I had the opportunity to join Data General to design a microprocessor-based computer. They had a successful 16-bit minicomputer line based on the NOVA and they wanted a NOVA

on an MOS chip. My only problem with this opportunity was that I didn't know what an MOS transistor was or how it worked. And once again I was off on a new odyssey: I didn't have the foggiest idea of how you did logic with microprocessors. Otherwise, I was excited about the challenge and took the job.

The first microprocessor, Intel's 8008, a P-channel, 8-bit device, had an accidental birth. It was the outgrowth of a contract with Datapoint who had specified the architecture for a microprocessor. After the contract period had expired and both Texas Instruments (the alternate supplier) and Intel had not delivered, the contract was cancelled. TI dropped the project but Intel chose to continue it and fund it internally. The rest is history in the microprocessor business.

Data General decided to use the newest technology: n-channel processing, which produced much faster MOS transistors, and silicon gates which provided additional interconnect capability. The decision was made to build the machine in-house at DG's

own semiconductor facility, which had been operational for about a year. The hardest part of designing a 16-bit computer on a single chip at a time when 8-bit computers represented the state of the art, was fitting it all onto the available area of silicon. The first decision was to use an internal 8-bit data path and arithmetic unit. I also decided to go to a serial i/o bus to solve some of the pin limitation problems. The adder would be the slowest part, even with carry predict circuits.

A second person was added to the project: a circuit designer in Sunnyvale. He showed me that registers are cheap and random logic terrible. With that information we decided to make a micro-coded machine, even though I had never done that before. In the process I picked up a Fairchild application book that had a picture of a PLA (programmed logic array) in the back. It looked like a nifty idea for instruction decoding. It also occurred to me that if you put a second PLA on the rear end of the first, all the decision making could be done by looking at the results of

operations and deciding what to do next. An area efficient design was developed with two PLAs for the sequencing. The chip also had a real-time clock in it and generated refresh addresses and refresh timing for the dynamic rams during periods where memory was idle and internal processing was going on in the chip.

It took me about a year to get educated and design the chip. Then we hired a technician to build a TTL simulator who put 1,000 i.c.s on wire wrap boards. He hand wired 20,000 connections to build the simulator and had it running in six months. It then took eight months to hand draw the IC layout. Because of the difficulties of the new process and the large line size, another year was consumed in getting all the details ironed out in order to make production units. Thus, it didn't ship until early 1976.

DG's single-board \$1,500 computer with the 8-K bytes of memory on a single board was equivalent to the DDP-516 that sold for \$82,000 a decade before. Adding a card cage and i/o, the price of the micro-Nova increased to \$8,300; one-tenth of the price of the previous decade.

1980: Fault-Tolerant Computers

The decision to start Stratus in 1980 was based on the apparent need for fault-tolerant computers in commercial on-line data processing environments as opposed to those built for scientific ones. This led to a new exploration since I didn't know anything about the subject. When I went to the MIT library, I was surprised to find volumes one through nine of the Proceedings of the Conferences on Fault-tolerant Computing oriented toward research and aerospace applications. The 1962 Apollo Guidance Computer built for NASA (that can be seen at the Museum) was a fault-tolerant machine. Only Tandem Computers had moved the technology to the commercial world.

Starting in 1974, Tandem had a 100 million dollar software intensive business by 1979. Any fault-tolerant system needs to be redundant until somebody invents parts that can heal themselves. The basic principle of Tandem was two computers side by side that could work with common mass storage. Errors are detected through memory parity or a stall alarm. A failure would restart the program at the last checkpoint on the backup machine. This software intensive approach could be a major problem with many terminals involved in online data processing applications. If the system



could allow some slowing down when a failure occurred, then the backup machine could be doing something useful driving normal operation. This solution had been invented in days of expensive hardware in 1974.

Stratus decided to build fault-tolerant hardware and not software. We chose a technique that required each element of the machine, such as the cpu board, to be able to detect its own failures. The simplest way to do this is to build two sets of everything and just before anything is sent out on the system bus, a comparator checks the two. If they aren't the same, the board is broken. With two boards, the work goes to the other board. This requires four sets of logic, which sounds expensive, but it isn't. I guess I should point out that we didn't figure out the scheme we used until after we raised the money for our startup.

One of the first things we did after the architecture was determined, was to put a red light on the end of a board to signal failure. Then field service didn't have to figure out what was wrong, but just take out the board and send it to the factory. Then we asked ourselves, "If field service isn't needed for fault detection, why are they needed on the customer site at all? Have the customer do it without a service call." This creates a new problem. The replacement has to be a fool proof insertion, without any special switches or an umbilical cord which might confuse the customer. In the final design, any board could be pulled out of a running machine and put in another one without anything happening.

Another problem was uncovered. How would we know what board to send to the customer for replacement? Could we depend on a secretary to pull out a bad board, read the model number, and accurately repeat it on the telephone? We thought that would be too much to ask. We added a feature that let the system read the slot location, the error state, the model number, revision level, and serial number of the bad board, finally throwing in a modem so that the computer could report the bad board directly to field service at Stratus. The electronic mail message to the Stratus computer reports what failed and all the details of the occurrence. The typical scenario is that the Stratus home office then calls up the customer and tells him that his machine has a failure. The customer doesn't know it until he's told. By then, the replacement board is on its way by Federal Express.



We also decided that there was no benefit in designing your own instruction set. It's fun, but a fool's errand if the objective is to make money. So we used commercially available microprocessors. We chose the 68000, the best machine in late 1979. Since we wanted to make a virtual machine, we found that the 68000 could not cope both with a page fault and restart, and at the same time go out and get a page from disk and lead it into memory. So two 68000s were put on each cpu board. The next step was to have part of the operating system run in the second 68000 in addition to the page fault handler. Then more and more processors were put in the system to run both operating system code and user code.

The second Stratus multiprocessor

system has six microprocessors running concurrently out of a very large shared memory. The four microprocessor version has a .125 microsecond memory cycle time and sells for \$200,000 with 4,000K bytes of main memory and a 400 megabyte disk.

A Continuing Odyssey?

It has been an adventure for me to be associated with all these computer projects. Once again I'm on a quest and will only be able to describe the avenues I explored when it is all behind me.

See How They Ran:

A Set of Classic Film Clips Showing Computing From 1920 to 1980

"See How They Ran" was assembled at the Museum and is shown there to illustrate the integration of hardware, software, other technologies and the environment of work in computing over time. Some clips were chosen because they show pioneering projects and others the flavor of the times. As a whole the film provides, in 35 minutes, a glimpse of the various components that have changed over time: size, ease of use, programming and software, and the attitude towards computers and computing.

The films were made for a variety of purposes and have different levels of sophistication. The common link is that each film is contemporary with what it is showing, very little historic interpretation is made at all. Further, all of the films were made with direct involvement of the people involved with computing at the time, rather than interpretations from other fields. The only exception is the silent ENIAC film taken in 1947, edited and narrated by Professor Arthur Burks, who was a graduate who worked on the machine, in 1981. Because of these attributes, the film has very unique pedagogical qualities—providing new insights and entertainment to trained computer professionals and the spirit of the tradition to students and interested people.

The Museum will now make this film available to others in order to serve our purpose as an educational institution.

IBM Punch Cards, 1920

This film about data processing before the computer illustrates one of its clearest antecedents.

The use of the punched card as a means of electro-mechanically storing and manipulating information was developed by Herman Hollerith for the U.S. Bureau of the Census for compiling the results of the 1890 census. The general idea of storing information on punched cards dates to the late 18th century and the use of punched cards to control the patterns woven in fabric by looms built by, among others, Joseph Jacquard. After developing machinery for the Census Bureau, Hollerith formed the Tabulating Machine Company, which later was incorporated into International Business Machines Corporation (IBM) by Thomas J. Watson. By the turn of the century several different companies were making punched card data processing systems for a wide variety of growing business uses.

The film clip shows a punched card operation of the 1920's. Women dressed in long dark skirts and white blouses transfer cards from one machine to another, and index and file them for storage. Each machine performed only one operation such as sorting cards, adding data, or printing, so the women were required to physically move the data from one machine to the next to perform a series of operations. Such systems were used through the early 1960's, when they were almost entirely replaced by computers.

ENIAC, 1946

late at night on February 13, 1946, the legend goes that the lights dimmed at the Moore School of Engineering at the University of Pennsylvania, when the 18,000 vacuum tube ENIAC was completely turned on.

Developed by J. Presper Eckert and John Mauchly, ENIAC stood for Electronic Numerical Integrator And Computer. The group who participated in the building and use of ENIAC met to discuss the next machine. In these meetings, the concept of the stored program computer was discussed and it can be said that ENIAC led directly to the development of the stored program computer.

The film show ENIAC in use computing ballistics tables which predicted the flight of a projectile under various conditions such as the wind speed and direction, the size of the shell and firing charge, and the inclination of the gun barrel. Before ENIAC, it took several people using desk calculators many months to complete such a table for a given trajectory.

ENIAC could compute the trajectory faster than real time; 20 seconds for a thirty second trajectory. However, this computation required two days of setting up the program to run on the machine. The film shows several women in knee-length skirts and bobby socks, clip-boards in hand, setting the switches on the front panel of the machine. In addition, wires had to be replugged to connect different logic components. Programming ENIAC, thus, consisted of determining how to wire the various functional components and set the dials to solve the problem.



Automatic Computing With EDSAC, 1951

Maurice Wilkes who built EDSAC narrates the film. Wilkes attended a summer school on the ENIAC held at the University of Pennsylvania in the summer of 1947, after which he returned to Cambridge University in England and started to build EDSAC, the first computer in regular operation to truly incorporate the stored program concept.

Two features, illustrated in the film, made EDSAC a more efficient computer to use and program: the internal storage of the program and the use of subroutines. Maurice Wilkes says, the film "can be seen as an advertisement for subroutines." The EDSAC programmers recognized that there were certain sets of instructions which they repeatedly used. Instead of reprogramming the operations each time they used them, they kept a copy of the set of instructions encoded on paper tape. Whenever they needed to include that particular routine in their program they simply copied the master tape onto the tape of their program. This improved the speed and accuracy of programming, and was the forerunner of higher-level, more powerful programming languages.



Whirlwind I: Programming at 3:00 A.M., 1953 From "Making Electrons Count"

This film clip was produced by MIT to demonstrate the use of the Whirlwind Computer Project. During the early period of computing in the US, computers were built almost exclusively for the federal government, particularly the military. While occasionally these early computer projects were undertaken by federal agencies or private organizations, the majority were developed at universities as government projects. The universities saw the benefit of computing for a wide variety of research and educational purposes. In the film a medical research scientist learns how to program the Whirlwind to perform a calculation for optical lens design. His experience illustrates what it was like to work on an early computer: the difficulty of writing a program which worked, the separation of the programmer from the machine, and how the computer ran only one program at a time.

Both the EDSAC and Whirlwind films were used by universities to show the advantage of using computers to do very difficult problems in a research and educational environment. Prior to this time, there were common statements that three to fifty computers would be sufficient for the world's problems. These films quickly provided evidence that every university, and then every department in every university, and every research lab would be soon writing applications to justify the addition of computers.



FORTRAN, 1957

By 1954, it became clear that computing was to grow as an activity and that a scientific language was needed to ease programming. FORTRAN, short for "formula translation" was being developed then by IBM and remains an important language today.

However, by 1957 it had not reached terribly wide acceptance. Many early programmers were emotionally committed to program in machine or very low-level languages. This film makes the case for programming in FORTRAN providing a very simple problem to contrast with machine language and shows a very serious advocate for this radical change.

Ellis D. Kroptechev and Zeus, A Marvelous Time-Sharing System, 1967

This student-produced film from Stanford University is a humorous spoof of the trials and tribulations of a college hacker condemned to use batch processing. Story set in the university computing center and cafeteria provides an accurate feeling for what it was like to program a computer during the 1960's.

It also illustrates an important transition from punched card batch processing computers, to time-sharing computing using teletypes and then video terminals.

Ellis D. Kroptechev is a "man with a problem, a girl and a deadline." We watch as Ellis struggles with jammed card punches, and numerous errors to complete his program in time and meet his girl friend. Ellis has to wait hours for his turn. Finally, when his program is run unsuccessfully, he must work through the listings by hand to find the errors. He cannot use the computer to assist him, in fact, he never even sees it, he can only submit his program on punched cards to the operator. In his final moments of despair Ellis is saved by Zeus, A Marvelous Time-Sharing System, in which he can directly enter the program into the computer, debug and run it himself. In no time his program runs perfectly, and in triumph he walks arm in arm with his girl friend into the sunset.



STRETCH: The IBM 7030, 1960-1981

This unique film, produced for the Museum, shows one of the first supercomputers ever built.

The IBM 7030 or STRETCH as it was called was designed between 1954 to 1961 to tackle the most advanced and demanding problems of scientific computation. It embodied many technological breakthroughs, and had a great influence on later IBM machines. The concept of the "byte" versus the "bit" was developed to represent an 8-bit "syllable" of the 64-bit long Stretch word. Then in 1964, the 8-bit byte was made into a de facto industry standard with the IBM 360.

Only seven STRETCH's were ever built.

The one filmed was pieced together for the Brigham Young University computer center from the original machines from Los Alamos and from Mitre, before it was shipped to the Museum. By then it had become a dinosaur with only a 256K primary memory of 64-bit words requiring a very large room and a team of attendants.

A Real-Time Event

On December 7, 1985 The Computer Museum held a very special event—"A Real-Time Event." Created by Susan Poduska, the gala evening was an unusual and ambitious combination of a multi-media fashion show which told the story of the "computer era" through music, dance, slides and commentary, plus a fundraising auction which featured over 60 unique items. A real-time success, the event attracted over 200 guests and raised \$35,000 for the Museum.

As searchlights criss-crossed the Museum's facade, they caught the 1956 T-Bird parked in the elevator just to set the mood. Guests mingled in the 5th and 6th floor galleries where silent auction items and bid sheets were displayed, and a sumptuous buffet was served, compliments of The Ocean Club.

The 5th floor auditorium outfitted with risers, runway and stage lights became a theater for a night. The slide show brought back the faces, fads, events, and inventions of the times, framing the models who performed vignettes choreographed to music that evoked the essence of each era. As the models swooned to "Mr. Sandman," commentators Susan Poduska and Donn Edwards told us of "Wizards and sages at MIT who were whirlwinding a new computer . . . and An Wang and

Jay Forester, busy stringing magnetic rings which became known as core memory, while UNIVAC earned fame in 1952 by predicting Eisenhower the presidential winner. Many liked Ike . . . but everyone loved Lucy!"

This multi-media production brought 40 years of memories to life. Fashions were gathered from every imaginable source—from GoodWill Industries to California computer chip artwear by Melissa Panages, from personal collections to the latest from Saks Fifth Avenue.

The show was followed by another production—the Live Auction. Channel Seven news reporter Hank Philippi as Master of Ceremonies was joined by industry stars Gordon Bell, Danny Hillis, Mike Parker, Bill Poduska and Jonathan Rotenberg as auctioneers. Throughout the evening guests bid on 45 silent auction items of all kinds. Auction co-chairs Joe and Carol Levy drew on companies and individuals from all sectors . . . restaurants, airlines, hotels, retailers and artists joined the computer community in making generous contributions to the auction. Who would have thought that Lorimar Productions, The Sheraton Corporation, and American Airlines would jointly offer a trip to Hollywood for lunch with Ana-Alicia on the set of Falcon Crest? or that Phil



Gwen Bell, Michael Templeton, and Committee Member Patti Marx, dressed in their Real-Time best.

Cooper would offer a flight on his WWII B-25 Bomber? Portraits, theater tickets, software, hardware, catered dinners, and a talking teddy bear were just some of the many wonderful items that helped raise the \$35,000 for the Museum.

"A Real-Time Event" was a major fund raiser (and fun raiser) thanks to the monumental efforts of chairperson and producer Susan Poduska, and auction co-chairpersons Carol and Joe Levy.

Their enthusiasm drew the participation of a particularly diverse and illustrious group of people all of whom gave generously of their time and talents. We would like to take this opportunity to express our deepest gratitude to the committee, the volunteers, the contributors and the museum staff—the people who made it all happen:

Bill Poduska inks in a bid for the silent auction on Liz Nolan's 'Bidmobile' while Danny Hillis (Thinking Machines Inc.), Susan Poduska, Event Chairperson and Museum Benefit Coordinator Linda Clingan look on.



PHOTOS BY ROGER FARRINGTON

The Fashion Show

Produced by Susan Poduska
Commentary by Susan Poduska and Donn Edwards
Directed by Donn Edwards, The Boston Ballet
Choreographed by—Bruce Wells,
Associate Artistic Director, The Boston Ballet
Fashion Coordinator—Pati Marx
Fashion Historian—Mary Lou Touart
Music Production—Edie Bowan, Goodtimes Music
Lighting Design—Visual Design Associates
Slide Show Production—Janet Cole
Script Research—Kate Jurow, Jurow Reynolds Associates
Stage Manager—Alexandra Lunn
Models from Copley Seven Agency
Vintage Clothing from the collections of:
Mary Lou Touart, Richard Talbot and Clemmie Lynn,
Uptown Strutters, Allston Beat
Contemporary Fashions by Saks Fifth Avenue
"Fashions that Inspire" by Le Chateau
Computer Chip Artwear by Melissa Panages

The Committee and Supporters:

Connie Bachman
Mary Baldwin
Gwen Bell
Linda Bodman
The Boston Computer Society
Linda Clingan
Caroline Collings
Cricket Press
Alice Del Sesto
Louise Domenitz
Ann Everett
Joyce Fredkin
Richard Friedman
Wendy Germain, Germain DRK
Carol Gilbaugh
Gourmet Caterers
Annie Roe-Hafer
Robert Hafer
Jack Hodgson
Anne Jenckes
Ben Kalica
Kathy Keough
Tom Labsley
Tim McNeill
Mary McKenney
James L. McKenney
Susan Parrish
Hank Phillippi
Ed Touchette, Graphic Designer
Emily Weiss
Bill Wisheart
Doris Yaffe, Saks Fifth Avenue
Matt Young, The Ocean Club, Cambridge

The Following Individuals and Companies Made Generous Auction Contributions

American Airlines
Apple Computer
The Arbor Inn
Arne's Fine Seafood
Bay Tower Room
Gwen Bell
Peter Benjamin, photographer
The Beverly Hills Hilton
Mr. & Mrs. Lawrence A. Bianchi
Bitstream, Inc.
The Boston Ballet Company
The Boston Computer Society
The Cambridge Center for Adult Education
The Charles Hotel
Continental Airlines
Phil Cooper, Palladian Software, Inc.
Debra Corbett, fine artist
Culinary Classics
Debra's Catering to Your Every Whim
The Cast of Dynasty
East Meets West
Face Life
Fifth Avenue Limousine Service
Debbie Germain, Piece-A-Cake
Gourmet Caterers, Inc.
GWV Travel, A division of The Interface Group
The Hampshire House
Hewlett Packard Company
Danny Hillis
Jameson and Thompson Framers
Javelin Software
Jonah's
Carol & Joe Levy
Lorimar Productions
Lotus Corporation
Lotus Development
Mr. & Mrs. James L. McKenney
Montanas
Natural Microsystems
NEC
New York Air
The Ocean Club
Nancy Philo Olsen, fine artist
Andrea Peters, fine artist
Hank Phillippi
Polymedia
Jerry Rabinowitz, photographer
Annie Roe-Hafer
Savenors Market
Sheraton Corp.
S.T. Dupont, Orfèvres a Paris
The Tandy Corporation
Robert Tinney, fine artist
Tomy Corporation
Toshiba America
The Wang Center for the Performing Arts
Warners Bros. Television & the Cast of "Spenser for Hire"
Michael P. Wasserman Associates

We would like to remind all the contributors and all the guests that every bit of their generosity sharpened the leading edge of the world's only computer museum.

Computer Graphics Image Contest

The Computer Museum and Raster Technologies Inc. are co-sponsoring The Second Annual International Computer Graphics Image Contest. The contest represents an international search for the most outstanding computer graphics image. Entries will be judged on both technical excellence and creative originality. As with last year's contest, the judges include the Museum's curator, Dr. Oliver Strimpel and members of the educational, technical and artistic communities: Dr. Richard Phillips, professor in the de-

partments of Aerospace Engineering and Computer Science and Engineering at the University of Michigan, Dr. Andries van Dam, professor of the Computer Science Department, Brown University, Ms. Terry Blum, fine artist and coordinator of the computer graphics lab at the Fashion Institute of Technology and Mr. Robert P. Holton, publisher of *Computer Graphics World*.

Prizes range from \$200 to \$2000 and winning images will replace the 1985 winners on display in *The Computer*

and the *Image* gallery at the Museum in September. Members are invited to submit entries and are encouraged to spread the word among friends and colleagues. Please contact Raster Technologies at (617) 692-7900 for further information and entry forms. Contest entries must be in 35mm slide format, and reach Raster Technologies by June 1 1986.



The Hexadecimal Puzzle

An Advanced Mathematical Puzzle With Sixteen Variations

The Computer Museum is offering you a limited opportunity to purchase The Hexadecimal Puzzle in an edition signed by the puzzle's inventor. The puzzle is offered to you at a cost of only \$39.95 (members \$35.95).

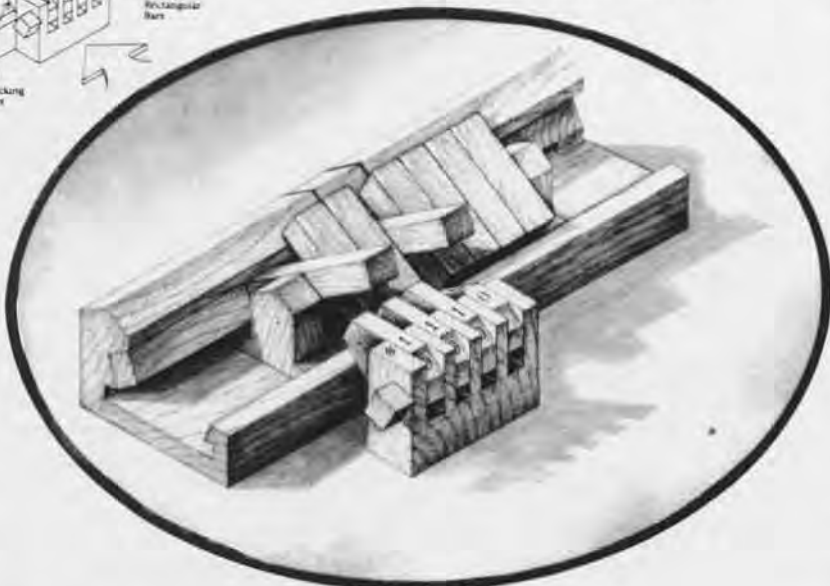
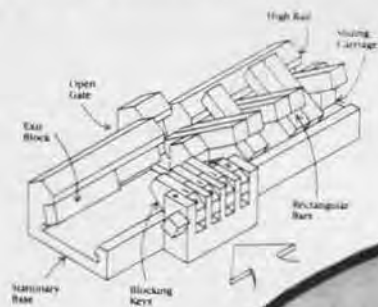

The Hexadecimal Puzzle is a binary switching sequence puzzle designed by William Keister, a pioneer in switching system theory and design at Bell Laboratories. The object is to remove the sliding carriage from the stationary base. This can be accomplished by switching each of the eight rectangular bars on the carriage from their initial position under the high rail to a position over the high rail. The switching action is hindered by a set of four blocking keys; to switch a given carriage bar, all bars to its left must have previously been switched to a pattern which matches the blocking key pattern for that bar.

Each of the four blocking keys can be adjusted by the player to a "0" or "1" position. Because of this, the blocking key pattern can be adjusted to 16 unique settings, forming sixteen unique puzzle sequences. Made of cherry wood, the Hexadecimal Puzzle is a handsome object as well as a challenging pastime.

Write The Computer Museum Store, or phone (617) 542-0476.

Spring Program Series

1 3

Robert McAndrews, President, The New England Commons
Wired Learning: The Future of Computer Networking in Higher Education

April 10

Dr. Peter Richter, Professor of Physics at the University of Bremen and Dr. Robert Devaney, Professor and Chairman of Mathematics, Boston University

Colors of Chaos
Background and explanation of the images in the exhibit
(see below)

April 17

Seymour Papert, Professor, MIT, Learning Epistemology Group, Media Lab
Computers and Learning in Early Childhood

May 1

Lillian Schwartz, Computer Artist Pioneer, Bell Laboratories
The Computer as a Medium in the Arts

May 8
1 Night

"Forbidden Planet", 1956, 98 minutes, color.
A classic science fiction film, "Forbidden Planet" is the story of an interstellar expedition that discovers the lone survivors of an earlier voyage. Morbius (Walter Pigeon) and his daughter are the survivors found amidst the remnants of an incredible advanced civilization whose inhabitants mysteriously vanished centuries before.

Lecture Series Thursday Nights at 7pm

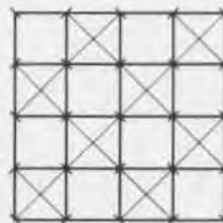

April 10

Colors of Chaos

An exhibit of computer generated images showing the iteration of complex functions.

A vividly colored series of images created by Dr. Peter Richter and colleagues at The University of Bremen, West Germany, shows the Mandelbrot Set and several Julia Sets. The function iterated here is simply squaring the complex number. Another series, by Professor Robert Devaney of Boston University, shows iterations of sine and cosine. The richness and beauty of the patterns was entirely unpredicted before computer exploration became possible.

The exhibit opens on April 10 with a special reception for museum members starting at 6pm followed at 7pm by a lecture. Peter Richter and Robert Devaney will explain what the images mean and how to generate such images yourself.

Courtesy of Heinz-Otto Peitgen and Peter Richter

The End Bit

0000000001

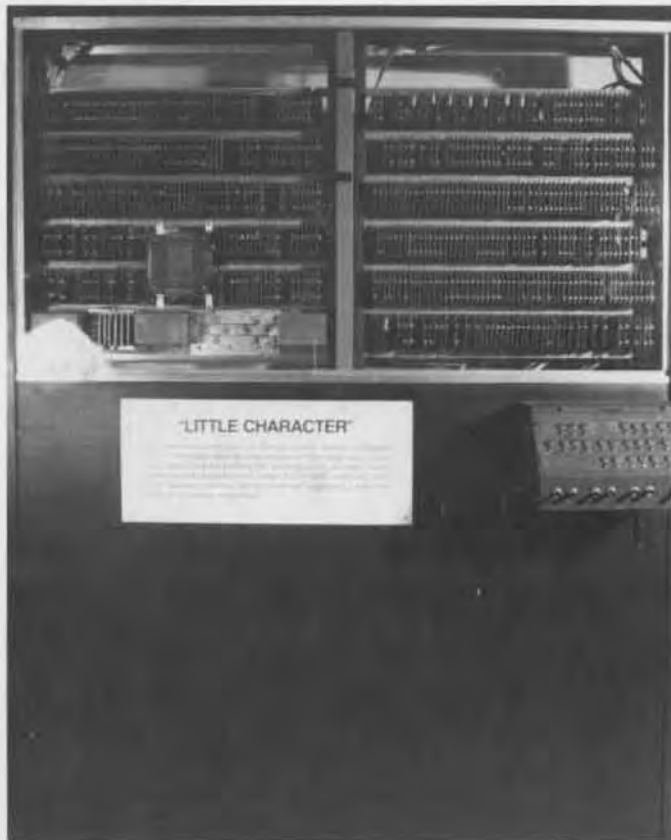

Little Character, by Control Data Corporation, 1959. The Little Character was a prototype computer developed to test the concept of modular circuit design at Control Data Corporation shortly after its incorporation in August 1957.

When he joined the young company in 1958, Seymour Cray tried to persuade president William Norris that there was a market for a low-cost, high-speed computer designed for scientific applications. Norris was sufficiently convinced to let Cray develop the Little Character. The machine used a small number of standard circuits made by loading transistors onto small circuit boards. These in turn were connected via a hand-wired backplane.

The Little Character vindicated Cray's modular design and Norris was convinced. The company then used the ideas embodied in the Little Character to build the Control Data 1604, a computer aimed at the low-priced scientific market.

On loan from Control Data Corporation, Minneapolis, Minnesota

Address Correction Requested

Non-Profit
Organization
U.S. Postage
PAID
Permit No. 110
Fitchburg, MA
01420



THE COMPUTER MUSEUM REPORT

VOLUME 16

SUMMER 1986

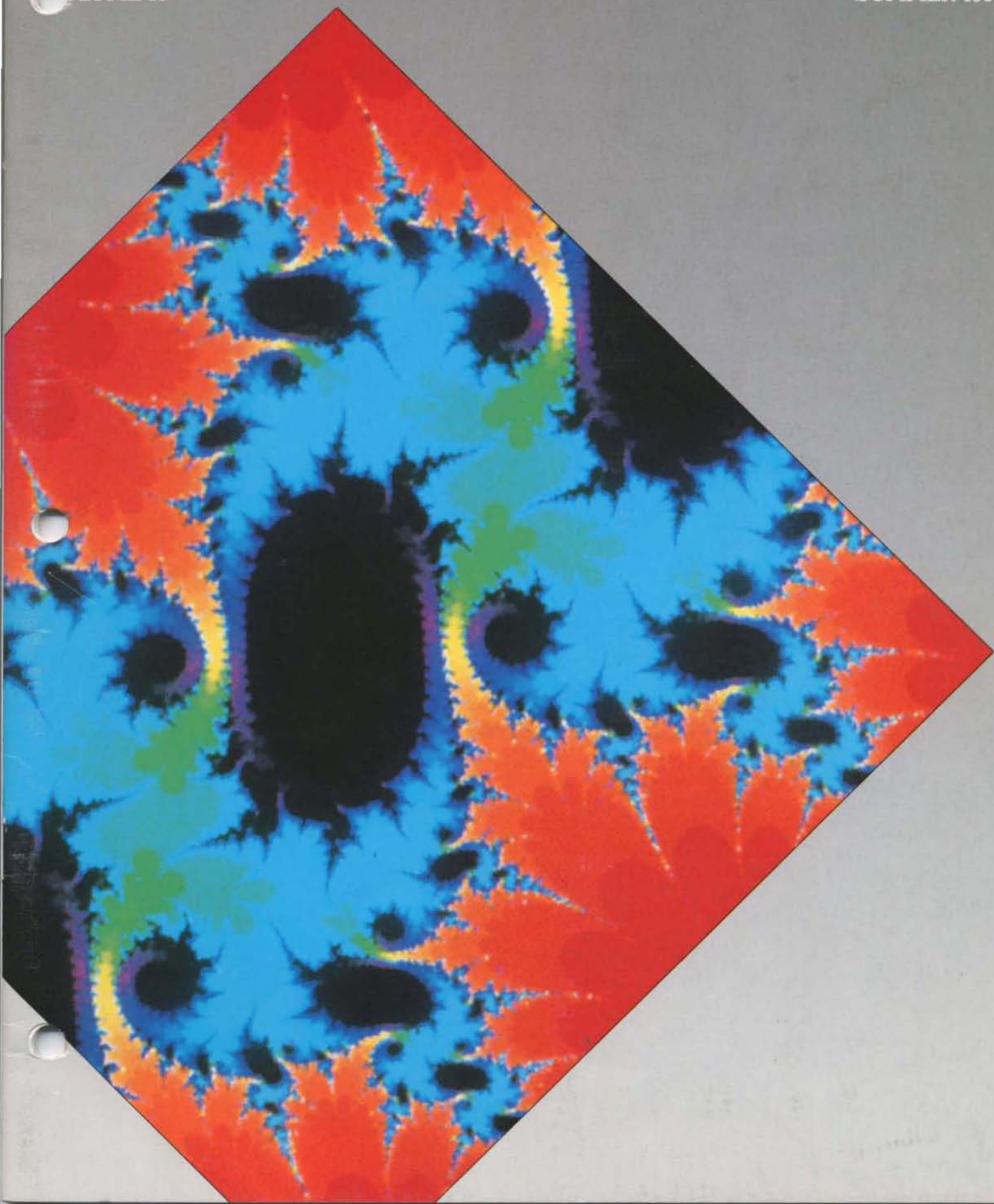

Board of Directors

John William Poduska, Sr.
Chairman and CEO
Belmont Computer, Inc.
Gwen Bell, President
The Computer Museum
Erich Bloch
National Science Foundation
David Donaldson
Ropes and Gray
Sydney Fernbach
Computer Consultant
C. Lester Hogan
Fairchild Camera and Instrument
Corporation
Arthur Humphreys
ICL

Theodore G. Johnson

Mitchell Kapur
Lotus Development Corporation

August Klein
MASSCOMP

Dr. Koji Kobayashi
NEC Corporation

John Lacey
Control Data Corporation

Robert Lucky
AT&T Bell Laboratories

Patrick McGovern
CW Communications, Inc.

James L. McKenney
Harvard Business School

Carver Mead
California Institute of Technology

William Millard
Computerland Corporation

Arthur P. Molella
The National Museum of
American History,
Smithsonian Institution

Brian Randall
University of Newcastle upon Tyne

Jonathan Rotenberg
The Boston Computer Society

Jean E. Sammet
International Business Machines

Edward A. Schwartz
Digital Equipment Corporation

An Wang
Wang Laboratories, Inc.

Maurice Wilkes
Digital Equipment Corporation

Trustees

Charles Bachman, C. Gordon Bell,
Harvey D. Cragon, Robert Everett,
Andrew Knowles, George Michael,
Robert Noyce, Kenneth Olsen,
Kitty Selfridge, Michael Spock,
Erwin Tomash, Paul Tsongas

Executive Committee

David Donaldson, *Chairman*, Gwen
Bell, Theodore Johnson, August Klein,
Nicholas Pettinella, Jonathan
Rotenberg, Ronald Smart, Oliver
Strimpel

Corporate Donors

Benefactor—\$10,000 or more
AFIPS, Inc.*
American Express Foundation
American Telephone & Telegraph Co.*
Apollo Computer, Inc.*
Bank of America*
The Boston Globe*
ComputerLand*
Control Data Corporation*
Data General Corporation*
Digital Equipment Corporation*
Hewlett-Packard
International Data Group*
International Business Machines, Inc.*
The MITRE Corporation*
NEC Corporation*
Raytheon Company
Sanders Associates
The Travelers Companies
Wang Laboratories, Inc.*

Patron—\$3,000

Addison-Wesley
Arthur D. Little, Inc.
Bitstream
Boris Color Labs, Inc.*
Burroughs Corporation
Coopers & Lybrand
Data Translation
DECUS*
Draper Laboratories*
Gaston Snow & Ely Bartlett*
General Computer Company
Gourmet Caterers, Inc.
Honeywell Information Systems
IEEE Computer Society
Intel Corporation
Liberty Mutual Insurance Company
Lotus Development Corporation
Major Computer, Inc.
MASSCOMP
McGraw-Hill, Inc.
Microsource Financial
NEC Systems Laboratory, Inc.
Nolan, Norton & Company, Inc.*
Phoenix Software Associates Ltd.
Prime Computer Corporation
The Prudential Insurance Company
Regis McKenna, Inc.*
Ropes & Gray
Software Results Corporation*
Stratus Computer, Inc.*
Sun Microsystems
Symbolics, Inc.
3Com Corporation*
i/u/s/i group
Venture Founders Corporation

Contributor—\$1,000

Access Technology
Adage, Inc.
Analog Devices, Inc.
American Management Systems*
Arthur Andersen, Inc.
Autographix
Automatix
Bank of Boston
Bank of New England
Baybanks
Bolt Beranek & Newman
Boston Safe Deposit & Trust Company
BusinessLand
Citicorp (USA), Inc.
Cullinane Foundation
Dane, Falb, Stone & Co.
Deloitte Haskins & Sells
E.J. DuPont DeNemours & Co.
Foley Hoag & Eliot
Ford Motor Company*
General Systems Group, Inc.*
GenRad
Gould, Inc.
Greylock
GTE Data Services, Inc.
GTE Laboratories, Inc.
Houghton Mifflin Company*
Hyams Trust
Index Technology Corporation
INNOVA
International Computer Ltd.*
Investment Orange Nassau, Inc.
LTX Corporation
Manufacturers Hanover Trust
Meditech*
Mentor Graphics
MICOM-Interlan, Inc.
Micro Control Systems
Microsoft*
New York Air*

Pathway Design, Inc.
PC Magazine
Peat, Marwick, Mitchell & Co.
Pell, Rudman, Inc.
Pencept, Inc.
Polesse-Clancy, Inc.
Price Waterhouse
Project Software & Development, Inc.
Shawmut Corporation
Standard Oil Corporation
Teradyne
Warner & Stackpole
XRE Corporation

* Contributed to the Capital Campaign

Core Members

Harlan E. and Lois Anderson
Charles and Constance Bachman
C. Gordon Bell
Erich and Renee Bloch
Howard E. and Jody Brewer
Henry Burkhardt III
Roger and Mary Cady
R. Steve Chehey
Robert C. and Eleanor W. Chinn
Pat Clark
Robert G. Claussen
William Congleton
Alex d'Arbeloff
Arnaud de Vitry
David Donaldson
Douglas Drane
Robert Everett
Kenneth G. Fisher
Jay W. Forrester
William Foster
Gardner Hendrie
Winston R. Hindle, Jr.
Peter Hirshberg
Theodore G. and Ruth T. Johnson
John Allen Jones
Mitchell Kapur
Allan Kent
Kack S. Kilby
August Klein
Andrew C. Knowles III
David J. A. Koogler
Edward and Debbie Kramer
John W. and Edna W. Lacey
Ralph and Linda Linsalata
John Norris Maguire
Richard D. Mallery
Thomas and Marian Marill
Daniel D. McCracken
James L. McKenney
Thomas and Elizabeth McWilliams
Carver Mead
Robert M. Metcalfe
Allen Michels
Robert M. Morrill
David and Pat Nelson
Robert Noyce
Kenneth Olsen
John L. Payne
Edward G. Perkins
Russell Planitzer
John William Poduska
Robert M. Price
Fontaine K. Richardson
Benjamin Robelen
Douglas Ross
Jean E. Sammet
Paul and Catherine Severino
Alan F. Shugart
Richard L. Sites
Ronald G. Smart
Charles E. Sporcik
Ivan and Maria Sutherland
Del Thorndike and Steve Teicher
Erwin Tomash
Jean De Valpine
Charles P. Waite
Stephen I. Watson
Harvey W. Wiggins, Jr.
William Wolfson

Contributing Members

Patron—\$500 or more

Anonymous, Ray Duncan, Tom Eggers,
Alan E. Frisbie, Tom and Rosemarie
Hall, Andrew Lavien, Nicholas and
Nancy Pettinella, Paul R. Pierce,
Jonathan Rotenberg, Oliver and Kitty
Selfridge, J. Michael Storie, Bob
Whelan, Leo R. Yochim

Sponsor—\$250

Isaac Auerbach, G. C. Beldon, Jr.,
Philip D. Brooke, Richard J. Clayton,
Richard Corben, Howard E. Cox, Jr.,
Lucien and Catherine Dimino, Philip H.
Dorn, Dan L. Eisner, Bob O. Evans,
Branko Gerovac, Dr. Roberto Guatelli,
M. Ernest Huber, Lawrence J. Kilgallen,
Martin Kirkpatrick, Marian Kowalski,
Raymond Kurzweil, Michael Lavitt, Carl
Machover, Julius Marcus, Joe W.,
Matthews, Tron McConnell, R. W.
Meister, Richard G. Mills, Joseph
Nestor, Joseph M. Newcomer, James N.
O'Boyle, Jr., Linda J. Phillips, J. Eric
Pollack, Linda & David Rodgers,
Thomas S. Roy II, William M. Steul,
Charles A. Stott, John V. Terrey, G.
Michael Uhler, Allan L. Wallack,
Andrew Wilson.

Donor—\$100

Kenneth R. Adcock, Lawrence Adrian,
Timothy Anderson, Rolland Arndt,
Richard G. Bohr, Art and Betty Bardige,
Steve F. Barneby, John C. Bartsow,
James Bell, Alfred M. Bertocchi, Dr. John
R. Blankenship, Richard C. Bloom,
Biontronics, Daniel S. Bricklin, Fred and
Nancy Brooks, D. F. Brown, Gordon S.
Brown, John and Ann Brown, Roger M.
Buoy, James Burnett, W. Carlson, Maria
L. Carr, Charles and Virginia Casale,
George Chamberlain, James F. Cody,
Michael Cronin, Daniel Crowley,
Curriculum Associates, David N. Cutler,
Nick De Wolf, Peter De Wolf, James B.
Deaderick, Delta Management,
Ditargiani Family, Theodora Drapos,
Joseph J. Eachus, Fred Ebeling, Dr.
Richard J. Eckhouse and Dr. Ruth
Maulucci, Lucian Endicott, Geoff
Feldman and Sharon Lipp, Larry F.,
Clark Frazier, Edward A. Feustal, Kevin
and Judith Galvin, David Goodman,
William Graustein, Stephen Gross,
Jerrie A. Haddad, Michael P. Halter, J.
Scott Hamilton, Frank E. Heart, Daniel
and Nancy Heff, Margaret Herrick,
Thomas L. Hohmann, Nancy S. Horie,
Charles A. Jortberg, Richard M. Karoff,
Bryan S. Kocher, Neal Koss, Alan and
Judith Kotok, Stanley Kugell, Robert
Laman, Curt Larock, Tsvi Lavi, John R.
Levine, John V. Levy, Reed Little,
George Logemann, Carl D. Lowenstein,
John Lowry, Lube, Inc., Arthur
Luehrmann, Andrew H. Mason, Robert
Mayer, Jr., Richard McCluskey, F.
Warren McFarlan, Jim McIntosh,
William and Vesta McLean, Todd
Medlock, Charles Minter, Allen
Moulton, Dr. J. Craig Mudge, Carol E.
Muratore, Dr. and Mrs. Isaac R. Nassi,
Cynthia and Richard Nelson, Tim K.
Nguyen, Bernard J. Nordmann, Anthony
Oettinger, Lawrence and Pauline Oliva,
John E. Parker, Kenneth D. Patterson,
James and Beverly Philip, Juan Pineda,
James A. Pitts, Andrew Plescia, James
N. Porter, David Potter, Robert C.
Probasco, Audrey Reith, C. Mike Riggle,
Ann and Robert Roe-Hater, David C.
Roh, Michael Rooney, Daniel Rose,
David Rose, Eugene Rudolphe, Howard
Salwen, Michael J. Samek, F. Grant
Saviers, Andrew Scott, Aaron and Ruth
Seidman, W. Lee Shevel, John J. Shields
III, Diane J. Skiba, Ph.D., Allen G.
Sneider, David Tarabar, William R.
Thompson, Warren G. Tisdale, Noah E.
VanDenburgh, Thomas Vaughn,
Christian Walker, Joseph B. Walters, Jr.,
Thomas E. Welmers, John D. Wick,
Hugh Wilkinson III, Kevin Willoug,
Paul Wittman, T. J. Wojcik, Jr., D.,
Wyse, Jeffrey N. Zack.

THE PRESIDENT'S LETTER

Contents

- The President's Letter
Gwen Bell
- 2 ENIAC
J. Presper Eckert
- 6 ENIAC Birthday Party
- 8 VisiCalc and Software Arts
Daniel Bricklin
- 11 Index to The Computer Museum
Report
- 16 Colors of Chaos
Oliver Strimpel
The End Bit 0000000001

Cover

Colors of Chaos.
Julia set of $(.1 + .17i)\sin(z)$ after
35 iterations by Robert L. Devaney,
Boston University (see article
on page 16).

The Computer Museum

The Computer Museum is a non-profit 501(c)3 foundation that chronicles the evolution of information processing through exhibitions, archives, publications, research and programs.

Museum Hours: The Museum hours are 10 AM-6 PM, Tuesday, Wednesday, Saturday, and Sunday and 10 AM-9 PM, Thursday and Friday. It is closed Mondays, Christmas, New Years, and Thanksgiving.

Membership. All members receive a membership card, free subscription to The Computer Museum Report, a 10% discount on merchandise from The Computer Museum Store, free admission and invitations to Museum previews. For more information, contact Membership Coordinator at The Computer Museum, 300 Congress Street, Boston, MA 02210, (617) 426-2800.

Staff

Dr. Gwen Bell, President

Dr. Oliver Strimpel, Associate Director and Curator
Kurt Levitan, Exhibit Specialist; William Wisheart, Registrar; Terry Mullins, Education Coordinator; Gregory Schroeder, Reservationsist; Gregory Welch, Research Assistant

Mark Hunt, Marketing Director
Lea Cohen, Store Manager
Louise Domenitz, Public Relations Manager
Linda Holokamp, Communications Assistant
Kathleen Keough, Functions Coordinator

Michael N. Oleksiw II, Development Director
Anne Jenckes, Development Assistant
Scott Reilly, Membership Coordinator

Ray Niro, Director of Finance and Administration
Jancy Dotters, Office Manager; Pat Pearson, Business Office Assistant

German DRK
Public Relations Advisors

Benson Clemons/BCOM Design

This young Museum is still filled with first experiences. Two are especially worthy of attention: three of our first interns have achieved important career objectives and the first members survey has been completed.

The Museum's first intern from the pre-Boston days, Beth Parkhurst, passed the general examinations in history for her doctorate at Brown University and has been awarded a Smithsonian Fellowship to study women in programming. Her first paper on the subject was presented at the 1985 meeting of the American Historical Association and will be published in *Daedalus*.

Gregory Welch, who took a year off from Harvard to work on the 1401, Cray, and manufacturing exhibits, has not only graduated Magna Cum Laude but also received the Shaw Travelling Fellowship. Greg will spend next year studying science and technology museums of Europe.

Bill Wisheart, who started as an intern on the collections after graduation from Boston College, has been accepted in the master's program in Computer and Information Sciences at Dartmouth College.

Survey of Museum Members

Almost 100 members replied to the first survey of the membership and it's my pleasure to publish its results. The respondents, from 25 different states, reflect the wide geographic distribution of members, with membership in 46 states, 9 European countries and Australia, Brazil, Canada, Japan, Indonesia and Israel. Before opening in downtown Boston, the ratio of local to non-local members was 2:3. Now it has reversed.

One-third of the respondents had visited the Museum three or more times and another one-third had never visited it. In the month of March, three percent of the visitors were members.

Preservation of computers and a liking for history were by far the most common reasons for becoming a member. Only 13% cited membership benefits as the reason for joining.

Respondents felt that the most important feature of the current membership plan is The Computer Museum Report. Thus, the Report is an important area where we can better serve members. The most interesting articles were on history, followed by anecdotes about artifacts, and articles about exhibits. The sense, in reading the individual comments, is that the Report should stand on its own. One written comment noted:

I like historical articles both about the museum collections and computing in general. I am not overly fond of reports about events or exhibits that don't make sense unless you have been there.

Many respondents would like the Museum to undertake more outreach activities and include more member participation. By outreach, people mean both travelling exhibits, events, and making films available. These projects are all within the long range plan of the Museum. The first step is making films available. For example, Sperry videotaped the Presper Eckert talk and will add the historic ENIAC film to it. The purpose is to make this available for distribution by the Museum and by Sperry. The Museum is also beginning to build up a data base for member involvement with a redesign of the membership renewal form allowing you to indicate your wish to actively participate. Collecting activities is one area where members can be particularly helpful.

It's very rewarding to watch the network of Computer Museum alumni and members grow.

Gwen Bell
President



Dr. J. Presper Eckert (foreground), co-inventor of ENIAC (Electronic Numerical Integrator And Computer). As the world's first all-electronic digital computer, ENIAC weighed more than 30 tons and occupied approximately 15,000 square feet. Performing 5,000 additions or subtractions per second, ENIAC launched the computer industry as we know it today. Dr. Eckert currently serves as Vice President and Technical Advisor for Sperry Corporation.

ENIAC

The Electronic Numerical Integrator And Computer

J. Presper Eckert

If you consider the ENIAC as the starting point, the computer is forty years old. So, by the way, is the United Nations and I feel that we've done alot better than they have.

Talking about the ENIAC is like going back into the attic of my mind. And going into my real attic, I found a clipping from February 15, 1946. It says:

"Mathematical brain enlarges man's horizons. . . A new epoch in the history of human thought began last night The scope and area in which man's brain can grasp, predict, control suddenly opened outward into the distance with revelation of secret construction during the war of a 30 ton mathematical brain that solves the unsolvable."

I read another article that said every time we turned the ENIAC on it dimmed the lights in West Philadelphia. This is pure fiction. We had it connected to a regulator in the generator room that was adequate for its power level.

Although the press notes that February 13th is when the machine was turned on, February 13 is an arbitrary date on which an announcement was made after some tests and trials. Other reporters stated that over 200 people worked on the project but the maximum group was 50 and the usual was about 30.

I met Dr. Mauchly at an advance management defense training course at the University of Pennsylvania. This course included about 30 people not in electrical engineering, of whom 16 were Phds. I was one of the lowest people on the totem pole; I was a graduate student and a teaching assistant. The meetings with Mauchly were along with a lot of very bright people. Mauchly and I had time to talk and we found that we both had a passion to build some kind of computing device. Mauchly had worked for the weather bureau and one of his motivations was to build a device that would help to predict the weather. The other thing that he had done as a professor of physics was build gas tube and neon lamp counters. I ran tests on them and found that they were not only slow but had very bad margins of safety, although they had the advantages of

being cheaper than vacuum tubes overall.

Those responsible for the ENIAC project and present at the dedication appear in the group photo. I reported directly to Dr. John Brainerd and he reported to Dean Pender, a very wise man, who had been head of electrical engineering at M.I.T. before he came to be dean at the Moore School.

Colonel Gillen, the contract officer for the Army at Aberdeen Proving Ground, named the ENIAC, The Electronic Numerical Integrator And Computer. Originally, the name stopped with Integrator because we had only planned to use it for equations relating to the flight of a shell. As time went on, various people felt that the machine should be used for other problems. Colonel Gillen realized the uses would get more complicated so he added "And Computer" to the name. He said this was political protection. If the general accounting office said we went beyond the original bounds, we could point to the name and say it was in the proposal.

Second to me in the photo is General Barnes, head of the Ordnance Department. In 1943, I reported to the Roxboro draft board consisting of a French teacher and two men in the textile business. They thought everyone should be drafted, especially everyone in textiles where the men could be replaced with women. They also thought that anyone at the University could not possibly be doing anything for the war effort. I was doing something, but they couldn't be told what it was. They thought I was a new form of draft dodger. Each time before they called me, the French teacher would forewarn me and the university staff could be prepared. The doctors knew me quite well because I actually took the preliminary exam six or seven times. When the French teacher went on vacation, the other two men decided they would get me. I was called without advance notice and almost drafted. By this time, the University realized the importance of the project, contacted the Ordnance Department and got a letter signed both by General Barnes, head of Ordnance of the US Army, and General Hersey, the head of selective service. The Roxboro draft board didn't harass me anymore.

After graduation from Penn, I worked at MIT's Radiation Laboratories building a special amplifier to test a switching device used in radar. The design of this amplifier, having a rise time of a tenth of a micro-second with a gain of over a thousand, gave me experience building high speed circuits. Then I had a project to measure a radar signal—travelling out and back—with an accuracy of 1 yard out of 100,000 in less than 9 nanoseconds. This was quite a problem because small, at the time, was 100 nanoseconds. I was instructed to do this with analog methods and decided in several weeks that they didn't know what they were talking about. I proposed a digital system using electric delay lines and another system using a mercury delay line that I invented for the purpose. Brit Chance, my boss, let me try my idea even though he didn't believe in it. I was working on that device using counters and delay lines when the idea for building the ENIAC came along.

While I was at MIT, Mauchly dictated a memo about the design of a computer that his secretary typed with several carbon copies. The original was given to Dr. Brainerd to mimeograph and distribute. Brainerd apparently lost the paper before it was copied. Herman Goldstine asked for one of the carbon copies; but no one



Presper Eckert.



Left to Right: J. Presper Eckert, Jr., Chief Engineer; Professor J.G. Brainerd, Supervisor; Sam Feltman, Chief Engineer for Ballistics, Ordnance Department; Captain H.H. Goldstine, Liaison Officer; Dr. J.W. Mauchly, Consulting Engineer; Dean Harold Pender, Moore School of Electrical Engineering, University of Pennsylvania; General G.M. Barnes, Chief of the Ordnance Research and Development Service; Colonel Paul N. Gillon, Chief, Research Branch of the Army Ordnance Research and Development Service.

could find one. Fortunately Mauchly's secretary still had her shorthand notes so she reproduced them for Goldstine who used them to get interest at Aberdeen Proving Ground. This formed the basis for Aberdeen's request for a proposal for a machine from the Moore School. Dr. Brainerd who was in charge of getting projects for the School was now pleased with the idea. The three of us wrote a proposal and delivered it to Aberdeen on April 9th, 1943 (my 24th birthday). Dr. Brainerd and Dr. Goldstine presented the proposal to Colonel Gillen and Dr. Deterick, a civilian scientist. During the presentation, Mauchly and I, sitting in the next office, wrote the technical appendices backing up the proposal. When the group emerged, we asked, "What happened?" Goldstine said, "We gave them the story and Deterick said, I've got to go to another meeting but it seems pretty good and Simon agreed to give you the money." After we caught up on our sleep, we started to work right away even though the contract did not arrive for several months. Actually, the ENIAC project started on April 10, 1943.

Herman Goldstine was a great help getting us classified documents on counters built by RCA and NCR. These counters were used by the Ballistic Research Laboratory to measure the speed of shells as they left the guns. I built both circuits and by modifying the RCA counter arrived at a very stable design. We then de-

cid on standards for the rest of the circuitry. I talked to the people at RCA's tube research laboratory in Harrison, NJ, about tubes and they shared the results of experiments where they got a much longer tube life by running them at lower voltages than consumer products. They also advised us to use standard tubes because they never got all the bugs out on special runs. They said it took 100,000 tubes before they were working right. I asked, "What do you do with the first 100,000." They said, "We sell them."

My education had prepared me to lead an engineering design team. At Penn Charter, I had a phenomenal math teacher who had put ten of us in a fast track studying solid trig, college algebra, differential calculus, and enough other material so that on testing at Penn I had completed the first year or so of engineering mathematics. Although I was admitted to MIT, my parents thought it would be better if I stayed closer to home and went to Penn. My father wanted me to study at the Wharton School of Finance, but I left after a short time because I hated it. I then went to the physics department but I couldn't get in because they were full and that's how I ended up in electrical engineering.

Carl Chambers, my advisor at the Moore School, was a mathematician, engineer, a former employee of RCA, and had a father who, at one time, was president of the American

Actuarial Society. When Carl grew up his father wrote the exams and would give Carl the summer job of grading them if he could pass it. And he always could. So he was also a fine statistician. When I got a D in something like nineteenth century English novelists, I went to him. And he said, "That's ok. I did the same myself. In fact, I figured if I got too good a grade on something I didn't like, I was spending too much time on it." Carl taught me the importance of very careful design. I did some circuit design for him and he always had me test it for all the variations possible. For the ENIAC, I implemented that idea with a vengeance. I didn't like the idea of ever making a failure by not doing it quite right; that can set progress back a step instead of forward. The Wright brothers were quite good in this way. They decided that Dr. Langley's equa-

tions that were available were probably not quite right even though his little plane had gone 4,000 feet powered by a steam engine. They decided to do something no one had done; build a wind tunnel first to test the wing designs. That's the real story behind Kitty Hawk. It's like the ENIAC: they didn't invent the engine or the idea of a wing or even the idea of an engine and a wing assembly. Another example is FM. In 1924, John Carson, who worked for Thornton Fry at Bell Labs, wrote a paper that worked out the equations for FM. He showed that in the normal ten kilocycle band width, FM would result in equally as much noise as AM. They also reasoned that building an FM detector was harder than AM and therefore they bypassed it. He was exactly right in all his mathematics, but of all the engineers who read it not one tried it. Then Major Armstrong came along and thought about it, saw that wide bands were available by then, and made FM work.

When we were building the ENIAC, the only other company I know who had experience building a machine with a large tube count was The Hammond Organ Company. They built about 1,000 Novachords, fully electronic musical instruments (synthesizers), each with 170 vacuum tubes. Eventually I bought an obsolete one for \$100 from a men's drinking society. I refinished the cabinet, repaired some circuits, and replaced all 1,000 resistors. When I retired my machine five years ago, all the 144 tubes (operating at about 5 volts versus the specified 6.5) in the tone generating part were original. If the tubes gave any trouble then we lightly sandpapering the pins and they would work again; the surface of the pins deteriorate but nothing else.

At the time we were hassled by a number of scientists for relying on vacuum tubes. Enrico Fermi knew an electrical engineer named Willy Higginbottam working on a 150 vacuum tube counter at Los Alamos. Fermi assumed that the level of engineering perfection that we used was the same as Higginbottam who had a much simpler problem. We knew what we were up against and had to have long life from the tubes. Fermi, a great statistician and physicist, ran statistics on Higginbottam's counters and told Dr. John von Neumann that with the number of tubes in our machine it perhaps would only run 5 minutes without stopping. Since the ENIAC was 1,000 times faster than anything else, if it only worked 5 minutes out of every hour or

so it would still be perhaps 100 times faster than any other machine. So we didn't worry about it.

The big surprise to us was that programming would turn out to be so enormously difficult. That was a shock to everyone. At the beginning, every time the machine came up with a wrong answer, we blamed it on a machine failure. We soon learned to blame it on a programming error. We were incredibly careful in designing the machine. I took a slide rule and rechecked every circuit that was designed at least to a rough approximation. I found that I had to do this or the rules that we had set were not being stuck to. We realized that we had about 4,000 knobs on the machine. We started to wiggle a few test knobs and found that they could come loose. Someone suggested that we use hardened set screws with a hole in the switch shaft. We tested them and no

knobs fell off. We "high potted all the wiring", that is we put it out on high voltage to check for weak spots in any insulation.

I had had experience with mice eating some forms of wire. So we got some mice, put them in a cage, starved them for a while, and then put in various kinds of wire that we were considering using. Sure enough, they loved some of the kinds of tubing we were planning to use. Then we used only wiring that passed the mouse test.

People often thought I was a nut because I was so fussy about standards, but I was only implementing the concept behind the famous statement of William Thompson, Lord Kelvin that Colonel Gillen had prominently hanging in his office. It stated, "When you measure what you are speaking about and express it in numbers, you know some things about it.

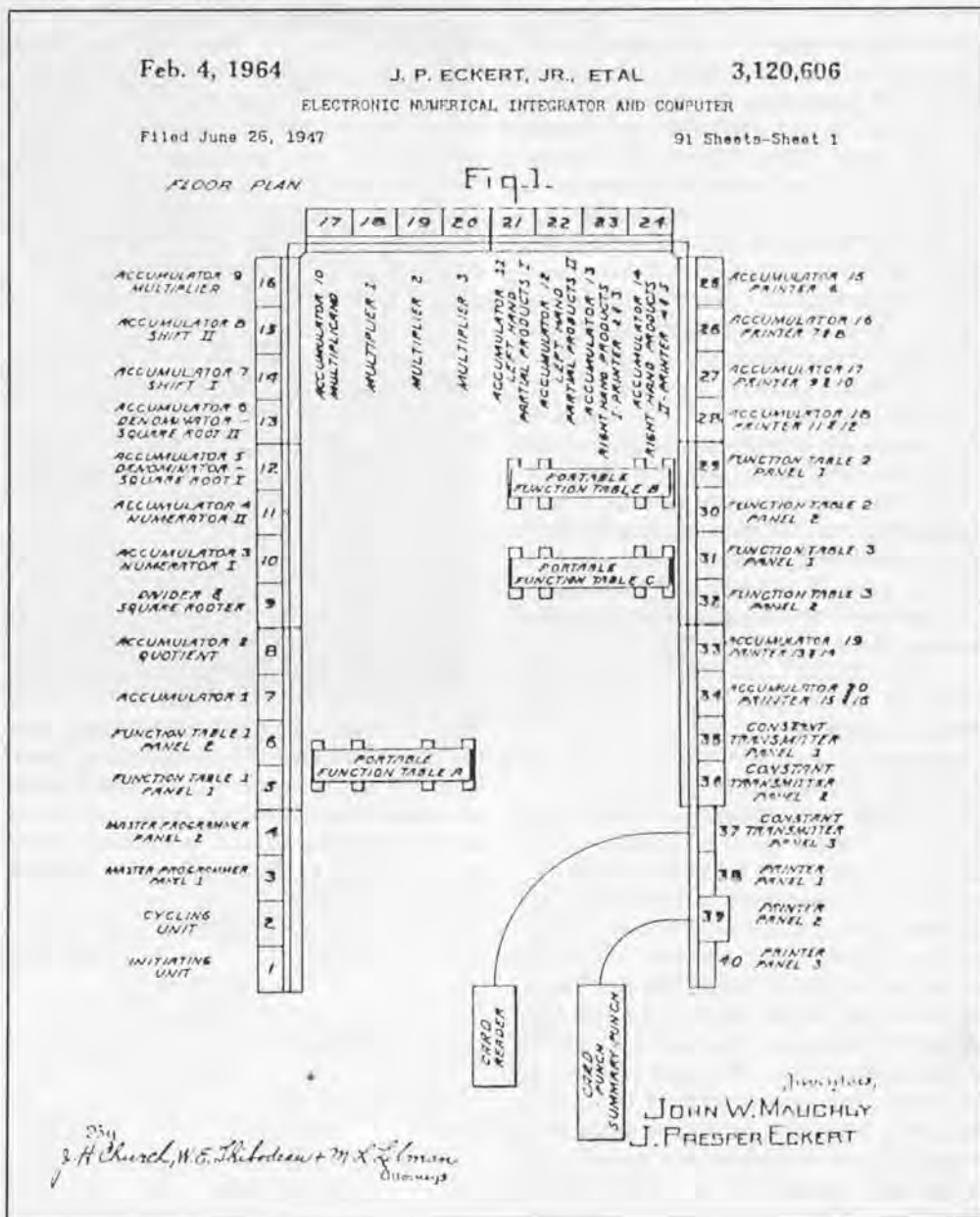

But when you cannot measure it, express it in numbers, your knowledge is of a meagre and unsatisfactory kind. It may be the beginning of knowledge but you have scarcely in your thoughts advanced the stage of science."

The other principle that I went on, was that one ought to be liberal about new ideas but be conservative on their execution. In later years, we had a big sign in one of our labs and it said, "Principle or execution." What it meant was, when something didn't work was it due to the principle or to its execution.

I sometimes see articles that say John Mauchly was the idea man and Pres Eckert the implementer. This is a vast over simplification. In the beginning, John had built some counters and I had worked on the differential analyzer. I had learned to use a desk calculator, but I didn't know as much about them as John. Mauchly knew how desk calculators worked inside. I had never integrated an equation by difference calculus. John taught me alot about the problems to be solved on the ENIAC. I had designed a lot more circuits than John. When we started the ENIAC, John introduced me to his concepts for a subroutine in the machine. It was one of the big principles of the ENIAC. Using a straight line programming as in the Harvard Mark I, I figured the ENIAC would have had over a million tubes instead of 18,000. I was told later that Babbage may also have had the idea of subroutines. Our idea was to have nesting of subroutines. If Babbage had the idea outlined, then Aiken probably would have used subroutines on the Mark I. We introduced Aiken to the idea of subroutines. What you can say is that John worked more on software and I worked more on hardware.

I think that I have enough evidence to show that I developed the idea of internal storage or the stored program. I proposed the idea to Mauchly. Arthur Burks, in an article in the *Annals of Computer History*, over and over again tries to compare the ENIAC to the Differential Analyzer. I think this is strange because I don't see any comparison. If there is a connection it is this: before Mauchly wroteup the ENIAC idea for Brainerd, we said the worst feature of the Differential Analyzer was the inaccuracy of the integrators. We had worked to achieve a one-hundredth of a percent accuracy from the previous tenth of a percent, but we decided we were at the top of an S curve. The machine might achieve a thousandth of a percent

accuracy, but only with hard work and that was the end of the curve. Further room for improvement would have to be electronic. We thought that we might take the shafts that came into the integrator, put little pinwheels with stripes on them, look at them with photocells and get pulses out that told how the shafts were spinning around. These would be fed into some counters, multiply these counters, accumulate them in another counter, and then use another pinwheel on the output shaft and feed it back through a servomechanism to make it track the thing. This was a mechanical integrator whose guts were sort of a digital system. We decided that was crazy, if we were going to have all these pulses then we should shoot them directly and get rid of all the gears. Then we thought this counting pulses is crazy, to count a million you need a million, but in the binary code it only takes twenty pulses. And even in a decimal system that can be based from a punch card machine, it will only take 60 pulses. So we decided we would code numbers and shoot them around that way in our machine. And that's about the extent to which the differential analyzer influenced the ENIAC. Later Dr. Floyd Steel developed the Digital Differential Analyzer that had some popularity for some time.

The best way to dismiss Atanasoff is to say the machine really never worked and he didn't have a system. That's the big thing about an invention: it's that you have a whole system that works. De la Rue tried to build a lamp in 1820, Starr in 1845, Swan in 1880, and Edison built a whole system that related to the generator that was only developed five years before. Every one of Edison's ideas had been used before. Edison was a system's engineer and made it all work. The ENIAC was built as a system that has led directly to today's computers. I look back at the scenario and ask you to consider the following question: How would you like to see your life's work end up on a tenth of a square inch of silicon?

ENIAC's Birthday

On February 13, 1986, The Computer Museum celebrated ENIAC's 40th birthday with a champagne-and-cake gala complete with 1940's orchestra to remind revelers of the era which gave birth to the machine.

ENIAC's Big Birthday Bash was conceived and sponsored by Ann Roe-Hafer, Marketing Director for Bitstream, Inc. of Cambridge. Starting in 1985, Bitstream dubbed February 13th the beginning of the Digital Year with a special calendar. The 1986 edition of the calendar was given to each attendee.

Many aspects of the event paid tribute to ENIAC's significant impact on the evolution of the computer. The invitation to the Birthday Bash was designed and produced using computer generated graphics featuring the special effects of digital fonts. ENIAC received the most fantastic birthday card ever produced by a computer for a computer, thanks to the Fantastic Animation Machine. They created a computer generated animated video birthday greeting that was displayed throughout the evening, and has now been added to the Museum's permanent collection. The 20-second long piece required about 100 hours of compute time and would normally cost about \$3000 per second of finished video—a labor of love to honor ENIAC and a show of support for The Computer Museum.



Presper Eckert and Kay Mauchly.

Maurice Wilkes, Gwen Bell, Mike Parker, Presper Eckert and Kay Mauchley.

The birthday cake for 500 guests was fashioned after a Bitstream font spelling out E-N-I-A-C. A tastier type there will never be. Among the decorations was a ten by one foot digital sign in the Museum elevator carrying a continuous birthday message.

To insure many happy returns of the day, eight "ENIAC Enthusiasts", AT&T, International Typeface Corporation, NCR Corporation, Michael Parker, John Poppen, XRE Corporation, Herman Zapf, and Zenith Data Systems, each contributed \$10 for every year of ENIAC's age to support the event and subsequent Museum projects.

The tribute to ENIAC was really a tribute to those who had created her. What turned this celebration into a momentous occasion was the talk by her co-inventor, Dr. J. Presper Eckert. Dr. Eckert's appearance drew a full house with close to 500 guests seated and standing in the auditorium, and watching on closed circuit T.V. in the galleries.

Bitstream president, Michael Parker was Master of Ceremonies for the evening. He first presented Bernard Gordon, President of Analogic, to introduce Dr. Eckert. Bernard Gordon, who had worked for Eckert Mauchly Computer Company, introduced Dr. Eckert as, "the greatest engineer and role model I've ever known". In his opening remarks, Dr. Eckert expressed his regret that co-inventor John W. Mauchly was not there to share his stories or be a part of the celebration. However, he noted that Kay Mauchly Antonelli, Mauchly's widow, and a programmer on the ENIAC, was in attendance.

After Dr. Eckert's talk, a film composed of the only existing original footage of the ENIAC from 1946 was viewed. It was met by the audience with both awe and amusement, and was a perfect transition from the inspiring talk by Dr. Eckert to the official toast and cake cutting.

Michael Parker, back on the podium, offered the first toast to the "41st digital year". The next toast "to the ENIAC" was given by Professor Maurice Wilkes, who studied the ENIAC before building the EDSAC. Kay Mauchly Antonelli toasted "the young ladies in the film", her fellow programmers. The closing toast by Dr.



Ann Roe-Hafer at the ENIAC function table, wearing the Eckert-Mauchly medallion.

Eckert was in memory of John W. Mauchly.

The Sperry Corporation, which absorbed the Eckert Mauchly Computer Company, is producing a video tape of the lecture and the 1946 film clips for the Museum's collection.

The ENIAC birthday celebration drew the attention of the media nationwide: it was featured on the CBS Morning News, National Public Radio's *All Things Considered*, WNEV-TV's *Sci-Tech Spot* and Cable News Network, and it was the subject of articles in *TIME* Magazine, the *New York Times*, the *Boston Globe*, the *Boston Herald*, and the *Baltimore Sun*. Also picked up by both the Associated Press and United Press International wire services, the story ran in over 50 newspapers across the country—from the *Honolulu Advertiser* in Hawaii to the *Tribune* in Scranton, Pennsylvania, from *Investor's Daily* in Los Angeles, California to the *Daily Southern Economist* in Chicago, Illinois!

Ushered into the world with special press conferences, the computer continues to hold public fascination with its growth from childhood to maturity.

VisiCalc and Software Arts: Genesis To Exodus

Daniel Bricklin

Bob Frankston, who wrote the first spreadsheet has noted, "In the early part of the century, with the growth of telephones, experts said that everyone in the world would be a telephone operator by the nineteen fifties."

People laugh and say, "That's not true."

But it turns out, it is true. By 1950 everyone had a dial phone and knew how to "be an operator."

Similarly, a few years ago, *Fortune Magazine* and others were predicting that a million programmers would be needed by the nineteen eighties. Now with a million users of VisiCalc, two million users of 1-2-3, and with another million users of other spreadsheets, four million people are programming on spreadsheets alone. The prediction is true. People just don't know they are programmers.

Ben Rosen once said, "You communicate with VisiCalc in English." What he meant was that you communicate in a way that feels natural, but it isn't English. It feels natural, but it's also a programming language. FORTRAN was also quite natural for people who worked with formulas. Unfortunately FORTRAN, when used to do other kind of programming, is strange and unnatural. Different kinds of programming languages are needed for different applications. The programming language is not important, but it is important that people program. In fact, a single computer language restricts a person to one way of thinking. If people learn spreadsheets and word processing, then they are on their way to programming.

In the early seventies, it was predicted that the first personal computers would be used to control the watering of the lawn, store recipes and do other household tasks. Personal computers are still not used for these tasks, but are used, among other things, to run spreadsheets. In fact, when new personal computers are announced a spreadsheet program is part of the package.

GENESIS

Bob Frankston and I met in late 1969 or early 1970 at MIT when we worked at



Bob Frankston and Dan Bricklin.

TECH Square at the now defunct Multics Project. We learned about good code and products that either did not capture people's imaginations or were not marketed well. After MIT, I went to Digital where I was project leader of the WPS-8, their first commercial word processor, and I also worked on computerized typesetting. This gave me a lot of experience with screens and editing. Bob was writing BASIC on a consulting basis for a small company, ECD Corporation, that was making a machine called the MicroMind (may it rest in peace).

I wanted to start a small business with Bob, so I decided to go to Harvard Business School to learn the "secrets" of doing this. I spent a lot of time in Aldrich 108 with 80 other first year students. Sitting there in the spring of 1978, I came up with the idea of the electronic spreadsheet. With all those other classmates to contend with the professor, there's lots of time for day-dreaming, especially if you sit in the front row and the professor looks out above you. I invariably made simple addition mistakes in my homework. I

wanted to do what the professor did on his blackboard: he would erase one number and Louis up in the back of the room would give him all the calculations that he had done all night to recalculate everything. I wanted to keep the calculations and just erase one number on my paper and have everything recalculated.

I had my little TI calculator that I would rest my hand on and imagine that it was a mouse-like object controlling a head up display similar to that of an airplane pilot. Then I could look ahead and say, "15% would be ok." Going with that metaphor I knew I wanted to move all kinds of things around. Getting more practical I thought it could be done on a micro like a Z80 with a screen and also a mouse. The first machine that I considered was the PDT from DEC, an LSI-11 based machine that didn't sell very well. Having heard about it, I learned that it would be on display at the annual shareholders' meeting. By holding one share of stock, I was able to go and see it. They were not very aggressive in trying to sell it to me. In the

summer of 1978, I made a decision that when I graduated in 1979 I would pursue creating the electronic spreadsheet on DEC equipment and maybe sell it door-to-door on Route 128.

Before I left for the summer of '78, I went to various professors for advice. I went to my finance professor, but he was busy and couldn't see me. I went to my production management professor and he said, "Well, that's really a good idea. People really use blackboards and they will use two roomfull of them to set up the numbers for manufacturing production schedules. If you could do that electronically and connect them, then it would save time." But he was too busy to help me. Nevertheless I was encouraged by what he said. Then I went to an accounting professor. He told me, "Improving the human interface to any system would be good." Finally, I got to see my professor of finance. Looking up from his FORTRAN listings, he said, "There are many financial forecasting tools already. The idea will never sell. People have everything they need. But why don't you ask one of my students, Dan Fylstra, and he'll tell you why you can't sell personal computers to real estate agents to do their calculations." That's how I met the person who eventually published VisiCalc.

Dan Fylstra, a second year business school student, was running a small home computer publishing company called Personal Software. He had just signed up a chess program called Microchess.

STARTING SOFTWARE ARTS

Frankston and I got together and decided we would work on an electronic spreadsheet in Bob's attic in Arlington, Mass.

One of the most difficult and important ideas was how to label where something was. It was clear to me that the simplest way was a grid coordinate system. Since people usually think in letters and numbers, I labelled the top with letters and put numbers down the side. My background had been on interpreters, on Multics I had implemented APL twice and VisiCalc is an interpreter. I used these skills and viewed VisiCalc as a programming language. Instead of the program being vertical, it was in two dimensions.

In the fall of 1978, we made a deal with Dan Fylstra that we would produce this electronic spreadsheet and he would publish it. We went to a Chinese restaurant out by Fresh Pond, Bob and I ordered without msg and

Dan with it, and we got some very good terms. Two-thirds of the profits, 35.7% of the gross, went to us. In those days, Dan's company, Personal Software, was in an apartment in Allston.

Then sitting in a Kentucky Fried Fish place, Bob and I came up with the name of our company, Software Arts.

That fall, I prototyped the product in 200 lines of BASIC to simulate the electronic spreadsheet. I wanted to have a mouse, but the machine that Fylstra had that was available to use, the Apple II, didn't have one. The Apple did have game paddles to turn the dial and move things sideways. So I modified it to behave like a mouse and position things. Unfortunately the cursor moved too slowly using the paddles so I switched to the two arrow keys, one going right and one left, and used the space bar to go up and down. Then it ran much faster.

The final version of the original VisiCalc was written on the MULTICS system at MIT which we paid dearly for out of our pockets. We used timesharing at night. Bob would get up at 3 PM when I would get back from school and work until 6 or 7 in the morning. Since MIT took three months to bill, we also had a little float.

The name VisiCalc was conjured up at "Vic's Egg on One" outside of Porter Square on Mass Ave. Early one morning, Frankston and Fylstra, desperate to come up with a name, were having breakfast and each claimed to have come up with the name. I claim they just looked at the menu that said "Vic's" — and were inspired. Frankston threw together the first working version of VisiCalc in two to three weeks.

In January 1979, Fylstra went off to Apple and Atari to show them the product. Markulla at Apple said, "Hm, interesting checkbook program you market it yourself, we're not interested." Atari was very interested but their machine was not ready. The first VisiCalc ad appeared in the May 1979 issue of *BYTE*. That same month, TI's personal computer was delayed and Radio Shack had 50% of the PC market. The year before, Apple had shipped 20,000 systems and IBM sold 5,000 systems in the PC market.

We sent copies of VisiCalc to influential people, including an analyst at Morgan Stanley in New York, Ben Rosen. Ben liked his copy (the one that is now archived at the Museum) and wrote about it, saying, "Someday this may be the software tail that wags the hardware dog." And he was apparently right, because the spreadsheet par-



tially made personal computers sell so well.

In June 1979, Software Arts moved from Bob's attic to a basement in Central Square, purchased our own Prime 550 timesharing system, and announced the product. Since I had just graduated and Bob was living like a student, we had simple requirements. We borrowed from friends and family to purchase the Prime. We didn't receive pay for about a year — and we used lots of float on Master- and Visa-cards.

"ALL HAIL VISICALC"

The first mention of VisiCalc in the *New York Times* appeared on the first page of the second section in a humorous article entitled, "A Layman's Trip into the Mega-mega Land of Computers." In giant letters, the author said, "All hail VisiCalc." He thought it was funny. We thought we could now say, *New York Times* says, "All hail VisiCalc."

In the winter of 1979, Software Arts moved again. Later, Julian Lange, a professor at Harvard, was hired and eventually became President. VisiCalc was then moved onto a large variety of machines. After a year, the original version was no longer sold, but replaced by an upgraded version.

We won Adam Osborne's White Elephant award for changing the course of industry. Our first cover shot was on the Boston Computer Society's *Computer Update*.

Then we had our first real competition. The Osborne I was announced with hardware and software bundled

together to give the user no choices. Osborne had to have a spreadsheet and convinced someone to write SuperCalc.

I received the Grace Murray Hopper award from the ACM, for something I had done under the age of 30. (Since I was no longer under 30, it made me feel good.)

Personal Software, riding on the wave of VisiCalc, published other things named "visi", like VisiTrend and VisiPlot, written by Mitch Kapor, their product manager for spreadsheets and other business products. Mitch met the people at Personal Software through Bob and me.

Bob and I appeared on the cover of *Inc. Magazine*, where, Software Arts was reviewed as a company for the first time. The rivalry with the publisher, Personal Software (eventually renamed VisiCorp) was mentioned.

VISI-WARS

Because of the rivalry with our publisher, Software Arts started to look toward scientific markets. TK!Solver was developed to do this and announced on the top of the John Hancock building in 1981. At this time, Micro-Finance Inc., a little company down the street, changed its name to Lotus Development Corp.

Software Arts was growing so much that it needed more space and moved out to 128 in Wellesley Hills where an old warehouse space was renovated. We spent lots of resources developing products for new PC's that weren't successful, such as the DEC 350 and TI's personal computers. The company spread its resources very thin. We announced an Advanced VisiCalc on the Apple III, with everything everyone wanted, except we chose the wrong machine.

Lotus 1-2-3 and TK!Solver shipped within a few weeks of each other. I was the youngest distinguished lecturer at MIT until Steve Jobs gave his talk. At this time, VisiCalc was still the most popular program on the IBM PC and the Apple III.

In the spring of 1983, we realized that TK!Solver was not bringing in enough revenue to pay for our development projects. We decided Software Arts either needed additional funding or to be acquired.

Returning from the airport after midnight in September 1983, I was greeted by the information that I was being sued by VisiCorp. You can't sell a company when you are being sued! Almost everything stopped for months while the lawyers took depositions. Af-

ter four days in court, it became clear that Software Arts would win the law suit a few years later. One day the next June, I was called back from the West Coast and we laid off half the employees to save money. That was about the most down day of my life. We

"Four million people are programming on spreadsheets alone."

finally hammered out an agreement with VisiCorp where we received all the rights to VisiCalc and a check for half a million dollars. It cost both sides a substantial amount of money and management time. Don't ever do it if you can help it.

Despite this, Software Arts came out with updated versions of VisiCalc and TK!Solver for the Macintosh, and Spotlight, a desktop manager program. But the company was under-financed and we were still trying to sell it.

During this depressing time, Frankston and I turned up in *Esquire's* list of special people under 40. It was really getting very bad and we finally switched to a bankruptcy expert for a lawyer.

EXODUS

In the spring of 1985, I decided to go to Softcon and ran into Mitch Kapor, Chairman of Lotus, at the airline counter. He said, "Hey, Dan, how ya doin'?"

I said, "Lousy."

"Not really."

"Ya, lousy."

Then Mitch asked, "Do you want to talk?"

I went from my seat in steerage up to first class and Mitch and I talked about the Software Arts situation. Mitch said since Lotus was starting a scientific division they might be interested. A day or so later, Software Arts made a presentation to Lotus. Within 48 hours a letter of intent to purchase some of the assets was signed. Frankston moved over to Lotus and I was given an office.

Then Lotus decided they would no longer sell VisiCalc, and the press wrote nice things about it.

Now, I work at home in my office at my new company, Software Garden, named after the Garden city of Newton Massachusetts, where I live. My product is a "slide show" type of program that lets you create a simulation that tries to appear indistinguishable from a real running program. It's a real program for the creators of vaporware.

INDEX TO THE COMPUTER MUSEUM REPORT

Contents of each issue
Issues still in print are available for \$3 each.

Vol. 1, 1982

The Director's Letter (The Founding of the Museum) - 1
Collections of the Museum - 4
Lecture Series - 11

Vol. 2, Fall 1982 (out of print)

The Director's Letter - Gwen Bell - 1
The Apollo Guidance Computer; A Designer's View - Eldon Hall; A User's View - David Scott; Comments - Dr. Charles S. Draper - 2
Whirlwind before Core - Jack Gilmore - 8
Portrait of a Board Member, C. Lester Hogan - 9
Museum News - 10
The Computer Historian's Bookshelf - 16

Vol. 3, Winter/Spring 1983

Companion to the Pioneer Computer Timeline - Gwen Bell - 1
Bell Telephone Laboratories Model 1 Complex Calculator - 2
Zuse Z1, Z3 - 3
ABC, Atanasoff Berry Computer - 4
IBM, ASCC (Harvard Mark I) - 4
Colossus - 5
ENIAC - 6
EDVAC - 7
IAS Computer - 8
EDSAC - 9
Manchester University Mark 1 - 10
Pilot ACE - 11
National Bureau of Standards SEAC and SWAC - 12
Whirlwind - 13
The Pioneer Computers: Comparative Statistics - 14
Additional Source Material - 16

Vol. 4, Spring 1983

The Director's Letter - Gwen Bell - 1
D. H. Lehmer's Number Sieves - Richard Rubinstein - 2
Inside *The Soul of a New Machine* - Tracey Kidder and Tom West - 5
collections of the Watson Scientific Laboratory, 1945-50 - Herbert Grosch - 8
Field Trip to North Bay Canada - Gordon Bell - 13

Vol. 5, Summer 1983 (out of print)

The Director's Letter - Gwen Bell - 1
Illiack IV - R. Michael Hord - 2
Installing the Illiack IV - Jay Patton - 6
Collecting, Exhibiting and Archiving - Jamie Parker - 7
Collections of The Computer Museum - 8
The Year's Programs in Review - Christine Rudomin - 18
The Computer Historian's Bookshelf - 20

Vol. 6, Fall 1983 (out of print)

The Director's Letter - Gwen Bell - 1
Creating archives for the History of Information Processing Symposium Report - 3
The Computer Museum's Video Archives - 4
The Museum's Video and Film Collection - 5
The Origin of Spacewar - J. M. Graetz - 6
Developing Univac's Plated Thin Film Metal Recording Tape - Ted Bonn - 13
Captain Grace Hopper on the Harvard Mark 1 - 14
Spring Events - 14
Pray Mr. Babbage. . . A Character Study in Dramatic Form - Maurice Wilkes - 16

Vol. 7, Winter 1983/4

The Director's Letter - Gwen Bell - 1
Computers: A Look at the First Generation - Paul Ceruzzi with Rod McDonald and Gregory Welch - 2
The Core Process: How Ferrite Cores were made for Computer Memories - 8
The Evolution of Software - Alan J. Perlis - 10
Museum Receives University of Illinois Collection - 12
Kurzweil Reading Machine - 13
Members Visit Museum Wharf - 14
Yard Sale - 15
Museum Slides - 16

Vol. 8, Spring 1984 (out of print)

The Director's Letter - Gwen Bell - 1
The TX-O: Its Past and Present - 2
Computing at the Burndy Corporation - Gregory Welch - 12
Fall Programs - 14
The Members' Association and Move to Boston - 16

Vol. 9, Summer 1984

The Director's Letter - Gwen Bell - 1
Computer Engineering Attitudes from Eckert-Mauchly to Analogic - Bernard Gordon - 2
IBM System/360 - Bob O. Evans - 8
Museum News - 19

Vol. 10, Fall 1984

The Director's Letter - Gwen Bell - 1
The Collection - 4
The Apple I - Brenda A. Erie - 11
Pre-Preview Party - 13
IBM System/360 - Bob O. Evans - 16

Vol. 11, Winter 1984/5

The Director's Letter - Gwen Bell - 1
Exhibits - 4
The Integrated Circuit: Origins and Impacts - Robert N. Noyce - 13

Vol. 12, Spring 1985

The Director's Letter - Gwen Bell - 1
Howard Hathaway Aiken: The Life of a Computer Pioneer - Gregory W. Welch - 2
A Conversation with The Hackers - 13

Vol. 13, Summer 1985 (out of print)

The President's Letter - Gwen Bell - 1
Computer Animation in the Museum - Oliver Strimpel - 4
The Story of the COBOL Tombstone - 8
Recollections of Memories from RCA in the Fifties - Jan Rajchman - 10
Honeywell Animals Find a New Habitat - 14
Questions about New Exhibits - 16

Vol. 14, Fall/Winter 1985 (out of print)

The President's Letter - Gwen Bell - 1
The Evolution of "C & C", A Japanese Aspect - Dr. Koji Kobayashi - 3
The Collection - 7
Blue Room Blues - 16

Vol. 15, Spring 1986

The President's Letter - Gwen Bell - 1
The Museum Mouseathon - Oliver Strimpel - 2
From the First 16-bit Mini to Fault Tolerant Computers - Gardner Hendrie - 6
See How They Ran: A Set of Classic Film Clips Showing Computing from 1920 to 1980 - 10
Museum News - 14

A

ABC - see Atanasoff-Berry Computer
 ACE Notebook 3/11
 Acoustic Memory, see Memory
 Adage Graphics Terminal 13/4
 Adams, Charlie 2/8
 Aiken, Agnes Montgomery 12/5
 Aiken, Howard 3/4-5; 6/14; 7/3; 12/Cover, 2-13
 Aiken, Louise 12/5
 Aiken, Mary 12/11
 AIMCO (Air Material Command Compiler) 13/8
 Air Almanac 4/8-9
 Allen, John 8/8
 Allen, Paul 14/15
 Altair 9/end bit; 11/9; 14/8,15
 Altair Users Newsletter 14/15
 Amdahl 470V/6 14/7
 Amdahl, Gene 5/18-9; 7/7; 9/11,12,16; 11/8; 14/7
 American Astronomical Society 4/8
 American Cyanamid 14/7
 American Mathematical Society 3/2
 American Totalizer 9/3
 Analogic Corporation 9/3-7
 Anderson Jacobson Acoustic Data Coupler 10/7
 Anderson, Robert 14/10
 Andre and Wally B. 13/7
 Annals of the Computation Laboratory of Harvard University, A Manual of Operation for the Automatic Sequence Controlled Calculator 12/7
 AN/FS Q-7 (SAGE Computer) 3/13; 4/13-4; 11/5; 13/11
 Alto 5/19
 APL 7/11
 Apple 1 10/11-2; 12/15
 Apple 2 14/9
 Apollo Guidance Computer 2/3-7; 6/15; 11/9; 15/8 LEM simulation 13/4
 Archives 6/3-5
 Argonne National Laboratory 3/8
 Armco Corporation 13/12
 Assembly programs 2/8
 Astronomy 4/8-12
 Atanasoff-Berry Computer 3/4,14-5
 Atanasoff, John 1/12; 3/4
 Atari 12/15
 Atlas Computer, Manchester 13/4
 Atomic Energy Commission 3/8
 Auerbach, Al 9/3-7
 AUTOMATH, Paris 14/3-5

B

B. Altman & Co. 7/7
 "B-lines" 7/7
 Babbage, Charles 3/5; 4/8; 6/16-23; 12/4
 Bachman, Charles 1/13; 4/14; 5/18
 Backus, John 4/12
 Bally Corp. 12/15
 Baraniuk, Steven 13/7
 Barlik, Jean 9/6
 Basche, Charles 5/18
 BASIC 7/11; 9/End bit; 14/9
 interpreter for the Altair 14/15
 Batch processing 11/7
 Beeler, Mike 12/13-5
 Bell, Gordon 1/1,13; 7/12; 8/5,9; 9/17; 12/13-5
 Bell, Gwen 15/5
 Bell Laboratories 2/2,9; 4/10,11/14; 12/14; 13/13; 14/3-4
 Relay calculators 1/12
 Model 1 3/2,4,14-5
 Model V 7/3,7
 Model VI 7/3
 Tradic 7/4
 Bendix Corporation
 D-12, Digital differential analyzer 7/7
 G-15 7/4,5,7

Bensky, Lowell 15/6
 Bessel Functions 12/6,9
 Best, Dick 8/11
 Berry, Clifford 3/4; 4/11
 Bigelow, Julian 3/8,10
 Billingsley, John 15/2-5
 BINAC 9/2-3
 Bletchley Park 1/7; 3/5,11
 Bloch, Erich 9/15
 Bloch, Richard 12/8
 "Blick" 5/13
 Blickensderfer, George 5/13
 Blumenthal, Ed 9/6
 Boston English High School 2/8
 Boston Technical High School 2/8
 Bouncing Ball 6/8
 Brady, Pete 8/5,8; 12/14
 Brainerd, John 1/13
 Brigham Young University 15/13
 Bromberg, Howard 13/8-9
 Brooks, Fred 9/18
 Brown, Theodore H. 12/5
 Bryce, J.W. 12/5
 Buck, Dudley 13/13
 Burkhardt, Henry 11/6
 Burks, Arthur 1/13; 3/6,7,8; 7/7; 15/10
 Burdy Corporation 8/12-3
 Burr, H. Page 6/end bit
 Burroughs
 B-6700 5/5
 B-500 10/5
 E-101 5/11
 ILLIAC IV 5/2-6
 UDEC #2 5/11
 Bush, Vannevar 3/4
 Byhavens 4/11

C

Calculators 1/8; 5/15; 10/8-9; 14/12-3
 Calculus 5/15
 CALDIC 7/6
 Calvin, Donald 12/8
 Cambridge University 3/9
 Campbell, Robert V.D. 12/8
 Canadian National Film Board 13/5
 Canadian National Research Council 13/5
Carla's Island 13/5-6
 Carmen, Carl 4/7
 Carpenter, Loren 12/5; 13/7
 Carr, John 2/8
 Catmull, Ed 13/7
 Centurion Industries, Digitor 14/14
 Character recognition 8/8
 China 14/3
 Cinematronics 12/15
 Circle Computer 7/6
 Clark, Wesley 1/11; 8/2,3,7
 Clippinger, R. F. 3/6; 4/14
 COBOL 13/8-9
 COBOL Tombstone 13/8-9
 CODASYL Committee 13/8
 Cohen, Harold 1/11
 Colossus 1/13; 3/5,14-5
 Columbia University
 T. J. Watson Astronomical Computing Bureau 4/8
 Watson Computation Laboratory 12/9
 Compilers 14/5
 Compometer 1/8
 Communications and computers 9/16; 14/3-6
 Comutek 14/10
 Computer-aided design 11/11; 14/11
 Computer animation 13/5-7; 14/9
 Computer architecture 5/3-6,10; 7/6-7; 15/6-9
 Pipeline 5/3
 SIMD (Single Instruction Multiple Datastream) 5/4
 Computer assembly 11/9



Computer Controls Corporation (CCC) 9/6-7
 DDP-24 15/6
 DDP-116, 316, 416, 516 15/7
 Micropac 15/7
 Computer Displays Inc 14/10
 Computer graphics 11/10-2
 Computer engineering 4/5-7
 Computer Research Corporation
 CRC 101 Digital Differential Analyzer 7/6
 CRC 102 7/6
 Computing Scale Company 9/9
 Computing Tabulating-Recording Company 9/9
 Comrie, L.I. 4/8
 Consolidated Engineering 7/7
 Cook, Rob 13/7
 Coombs, Allen 10/10
 Conant, James Bryant 12/5, 6,7
 Control Data Corporation (CDC) 11/8
 "Little Character" 11/8; 15/end bit
 160 15/6
 1604 11/8
 6600 1/5; 11/8,15
 7600 11/8
 Corbato, Fernando 9/15
 Core memory, See memory
 Crago, Robert 4/13
 Crawford, Perry 3/4
 Cray Research
 Cray-1 4/3; 11/8
 Cray-2 11/8
 Cray XMP 11/10
 Cray, Seymour 1/5; 5/7; 7/7; 9/15; 11/8; 15/6
 CRT display 4/13; 6/6-12; 7/5
 Crystal Globe 14/11
 Cullinane, John 1/13

D

Darlington, Syd 2/1
 DARPA 5/2-6
 Dartmouth College 3/2
 Data General 4/5-7; 15/7-8
 Eagle 4/5-7
 Eclipse C330 11/9
 Micro-NOVA 15/8
 NOVA 2/end bit; 11/6
 Datapoint 15/8
 DATRAC 9/5
 Davies, Donald 10/10
 Davis, Joe 9/5
 Debugging 1/12; 3/9; 6/7
 DDT (Digital debugging tape) 8/6; 12/15
 DEC 330 Scope 14/11
 DECUS (Digital Equipment Computer Users Society) 6/11; 8/11
 deCastro, Edson 4/7; 11/6
 Dennis, Jack 6/7,11; 8/2-11
 Dettman, Morris 13/14-5
 Dibley, Alan 15/3

Dickinson, Halway 4/9
 Digital Equipment Corporation 1/2-3; 8/8,11; 15/6;
 see also, PDP and VAX modules 5/7
 Digitor 1/14
 Diodes 3/12; 7/3-7; 11/13
 Dirks 3/3
 Draper, Charles Stark 2/7
 Draper Laboratory 2/3-7
 Drucker, Daniel C. 7/12
 Dual-in-line integrated circuit packaging 5/10
 Duff, Tom 13/7
 Dummer 2/1
 Dunwell, Steven 9/13
 Durfee, Benjamin N 12/5,6,7,9

E

Eastlake, Donald 12/13-5
 Eberlin, Kris 2/end bit
 Eccles-Jordan flip flop 4/9
 ECHO IV 14/end bit
 Eckert, J. Presper, Jr. 3/6,7; 6/13; 9/2-7; 11/6; 13/10
 Eckert, Wallace 4/8-12; 12/9
 Eckert-Mauchly Computer Corporation 6/13; 9/2-7
 Eclipse, see Data General
 Edwards, Dan 6/7,9-12
 Edwards, David 1/13; 3/10
 EDSAC 1/2; 3/3,9,14-5; end bit; 4/3,9; 7/5,7; 15/11-2EDVAC 3/6,7,8,9,14-5; 7/5,7
 Egeland Air Force Base 8/8
 Eggers, Tom 12/13-5
 Election predictions 5/11
 EMACS 12/14
 Engineering Research Associates (ERA) 11/8
 "Abel" 7/4
 "Logistics Computer" 7/8
 1103 7/5-7; 8/8; 11/8
 1103A 7/5
 ENIAC 1/13; 3/3,5,6,7,14-5; 4/3,9; 7/3-7; 14/4;
 15/10,11,12
 Enigma 1/7; 3/5
 English Electric DEUCE drum 5/3
 EPSCO Inc. 9/5
 Eratosthenes 4/3
 ETL Mark I 14/3,4
 ETL Mark II 14/3,4
 ETL Mark III 14/3,5
 ETL Mark IV 14/3,5

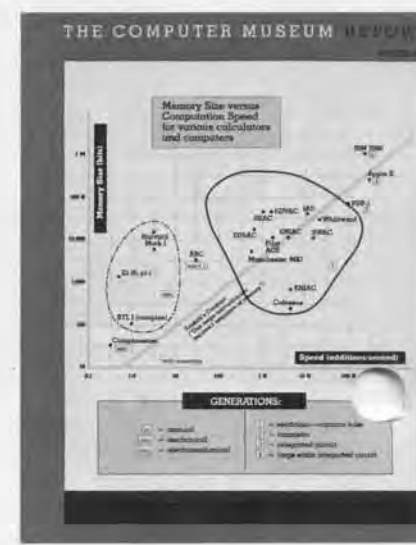



ms, Robert O. 9/8-17; 10/18
 erett, Robert 1/1; 4/13; 8/11
 Expensive Planetarium 6/11
 Expensive Typewriter 6/9

F

Fairchild Camera & Instrument 2/9;
 5/2-3; 11/14
 256 bit memory chip 5/2
 PLA (program array logic) 15/8
 Symbol 5/10
 Fano, Robert 9/16
 Fault tolerant computers 15/8-9
 Felkel, Anton 4/2
 Ferranti Mark I 7/7
 Film archives 6/3-4
 Finland 15/2
 Finn, George 4/11
 Flexwriter 2/8, 9; 6/7, 8; 7/3, 5; 8/6; 9/6
 Flight simulation 3/13
 FLIT (Microflit) 6/7-9; 8/6
 Flowers, T. H. 1/13; 3/5; 10/10
 Flowmatic 13/8
 Foldes, Peter 13/4-5
 Forgie, Jim 8/2
 Forgie, Karma 8/2
 Forrester, Jay 1/12; 2/8-9; 3/13
 FORTRAN 9/15; 15/6, 13
 Fractals 11/10
 Frankovich, John 8/2
 Franz, Gene 5/12
 Fuji film Corp 14/4
 FUJIC 14/3, 4
 Fujimura, Osamu 8/5, 8
 Fujisaka, Hiroya 8/5, 8
 Fujiwara, Eiichi 15/3-5
 Fujiyama Club, Hiroshima Prefecture
 15/3

G

Gates, Bill 14/15
 Gehring, Art 9/6
 General Data Communication
 Industries 14/8
 General Electric 4/11
 General Motors A C Sparkplug Division
 2/3
 Germany 3/3
 Gibson, John 9/15
 Gilmore, John 8/2
 Gilson circular slide rule 5/14
 Goldstine, Herman 3/8; 7/7
 Good, Craig 13/7
 Good, J. J. 3/5
 Gordon, Bernard 8/15; 9/3-7
 Gordon Institute 9/7
 Graetz, Martin "Shag" 6/7-12, 9; 8/8, 10;
 11/12
 Goto, Eiichi 14/4
 Griffith, John 9/11, 12, 16
 Grosch, Herbert 4/12-5
 Gross, Dave 8/9
 Grove, General 4/9
 Grumman Aircraft 2/3
 Gurley, Ben 8/7

H

Hackers 6/7-12; 12/13-5
 Hal, Eldon 1/2-7; 6/15
 Halle, Morris 8/9
 Hamilton, Frank E 12/5, 6, 7
 Hamm, Ron 13/9
 Hammond, Joe 7/13
 Hammond Typewriter Co. Multiplex
 5/13

Hark 8/4
 Hartree, Mrs. Douglas 10/10
 Harvard University 12/3-13
 Littauer Statistical Laboratory 6/7
 Mark I 3/3, 4, 5, 14-5; 4/10/ 6/14;
 12/3, 5-9
 Mark II 7/6; 12/3, 9
 Mark III 7/2, 6; 12/3, 10
 Mark IV 7/6; 12/3, 10
 Hawkins, W.R. 8/12
 HAX 6/8
 Heinz, John 8/5, 8
 Hendrie, Gardner 15/6-9
 Hewlett Packard
 150 11/9
 7568B plotter 11/11
 Hindenberg, Karl 4/3
 Hingham Institute 5/7-11
 Hoerni, Jean 11/13
 Hogan, C. Lester 2/2, 9
 Hollerith, Herman 9/9; 15/10
 Hollerith machines 4/8
 Home computer 14/end bit
 Honeywell 9/16; 15/6-7
 animals 13/14-5
 Hopgood, F.R.A. 13/4
 Hopper, Grace 3/5; 6/14; 7/7; 10/10;
 12/Cover,
 6, 7; 13/8-9
 House, Arthur 8/9; 12/14
 Hudson, Bob 8/2
 Hughes Aircraft 7/5
 Hughes Charactertron tubes 4/13
 Humphreys, Arthur 13/1
 Hunger 13/4-5
 Hurd, Cuthbert C. 9/9-12
 Huskey, Harry 3/12; 4/15; 7/4, 5, 7



I

IAS (Institute for Advanced Study)
 Computer 3/7, 8, 10, 14-5; 7/5, 7
 IEEE Computer Society 15/2-5
 Idani, Masaru 15/3-5
 ILLIAC I 5/3; 7/12
 ILLIAC II 5/3; 7/12
 ILLIAC III 5/3; 7/12
 ILLIAC IV 4/4, end bit; 5/2-6, 7; 8/15
 Image processing 11/10-2; 14/11
 Index registers 7/7
 Institute for Numerical Analysis, Los
 Angeles 3/12
 Integrated circuits 11/13-5
 Intel
 4004 14/14
 8008 14/8; 15/8
 8080 9/end bit; 14/15

INTELCOM, Atlanta 14/6
 International Business Machines
 Corporation (IBM)
 3/4; 4/8-12; 9/8-17; 14/6, 12; 15/10;
 see also AN/FPS Q-7, Harvard Mark I
 (ASCC)
 card accounting system 8/12-3
 CPC 4/11
 NORC (Naval Ordnance Research
 Calculator) 4/8, 11, 12
 RAMAC (Random-Access Memory
 Automatic Computer) 9/11-2
 SCAMP I, II, III 9/14
 SLT (Solid Logic Technology) 9/15
 SMS (Standard Modular System)
 9/14
 SNA (Systems Network Architecture)
 9/17
 SSEC (Selective Sequence
 Electronic Calculator) 4/8-12; 10/6;
 12/9
 Stretch (7030) 1/4; 5/19; 9/12-3; 15/13
 System 360 9/8-12; 10/18; 14/7; 15/7
 System 370 14/7
 083 Sorter 8/12-3
 088 Collator 8/12-3
 405 Tabulator 4/10
 519 Reproducer 8/12-3
 557 Interpreter 8/12-3
 603 Calculating punch 4/9
 604 4/11
 608 7/4
 610 4/11
 650 5/4, 5, 7; 7/4; 9/12
 701 4/11; 5/11, 18; 7/6, 8; 9/10
 702 9/11
 704 5/18; 6/7; 9/10-11
 705 9/11; 13/8
 709 9/11-2
 1401 8/12; 9/12, 13, 16; 11/7; 14/5
 1410 9/14; 11/7
 1440 11/7
 1460 11/7
 1620 9/12, 14
 2205 14/10
 7040 9/15
 7044 9/15
 7070 9/11, 13, 15-6
 7072 9/15
 7074 9/15
 7080 9/11-12, 15-6
 7090 8/6, 10; 9/12, 15-6; 12/11
 7094 4/4; 9/15; 12/4; 14/11
 8000 series 9/13-4
 International Computer Graphics Image
 Contest, 1st Annual Winners 13/16
 International Time Recording Company
 9/9
 Iowa State University "Symbol" 5/10
 "IT" 7/7*

J

J. Halden & Company, Calculex 5/15
 Jacoby, Marv 9/6
 Japan 14/3-6
 Defense Agency Research
 Laboratory 14/5
 Ministry of International Trade and
 Industry (MITI) 14/4;
 Electro Technical Laboratory 14/4-5
 ETL Mark I 14/3-4
 ETL Mark II 14/3-4
 ETL Mark III 14/3, 5
 ETL Mark IV 14/3, 5
 Science Foundation 15/3
 Japan Micromouse Association 15/2-5
 Japan System Design Co Ltd 15/3
 Jay, Billy 9/6
 Jo, Kenzo 14/4
 JOHNNIAC 5/16; 7/4, 7; 13/11-2
 Johnson, Harwick 2/2
 Jones, Gilbert 9/13
 Jones, John L. 13/8-9
 Jones, Larry 9/6
 JOSS 7/7
 Jovial 4/14

K

Kapor, Mitchell 10/2, 3
 Kidder, Tracy 4/5-7
 Kilburn, Tom 3/5, 10; 10/10
 Kingsbury, Douglas 13/6
 Kinki Nippon Railways 14/5
 Klein, August 13/1-2
 Knowlton, Ken 13/4
 Kobayashi, Key 15/3-5
 Kobayashi, Koji 10/3; 14/3-6
 Kokusai Denshin Denwa Co 14/4
 Kollmorgen Corporation 6/end bit; 7/13
 Kollsman Instrument 2/3
 Kotok, Alan 6/7-12, 8; 8/6, 9-11; 12/13-6
 Knight, Tom 12/13-5
 Kueffel & Esser planimeter 10/8
 Kurzweil Reading Machine 7/12; 8/14
 Kyle, Bill 2/8-9

L

Laboratory for Electronics 9/5
 Lake, Clair D. 12/5, 7, 9
 Lake wire contact relay 4/10, 11
 Langridge, Robert 8/14-5
 Lasseter, John 13/7
 Last, J. 11/14
 Lawrence Livermore Laboratory 1/5;
 9/9, 12-3; 13/5-6
 Learson, T. Vincent 9/13-4, 16, 18; 12/6
 Lefler, Sam 12/7
 Legendre, A. M. 4/3
 Lehmer, Derrick Henry 4/2-4, 14
 Lehmer, Derrick Norman 4/3-4
 Lehovic, Kurt 11/14
 Lenz, John 4/11
 Lentief, Wassily 12/9
 Levy, Steve 8/9; 12/13-5
 Levitt, Si 9/6
 Li, Francis 8/8
 LINC (Laboratory Instrument Computer)
 1/11; 11/9
 Lincoln Laboratory see MIT
 Light pen 8/4
 Loon, Hans Peter 4/11
 Lovelace, Lady Ada 12/4
 Livingston, Hugh 12/8
 LOGO 12/15
 Los Alamos National Laboratory 3/8;
 4/9; 9/9; 11/8
 Lowell Tech 2/9
 Lucasfilm 8/10
 Lucky, Robert 13/2-3
 Lukoff, Herman 9/6

M

Machine Language Programming for the 8008 14/8
 MACRO 6/7-9; 8/1,6
 Magic 7/7
 Magnavox 12/15
 Mahoney, John 12/8
 Major Computer Inc 14/7
 Manchester University 3/5,8
 Mark 1 3/10,14-5
 Mandelbrot, Benoit 11/10; 13/5
 Manhattan Project 4/9; 12/9
 Mappy 15/3,4
 Marks, Cecil 10,10
 Mason, Sam 8/8
 Massachusetts Institute of Technology (MIT) 6/7-12; 8/2-11; 9/16; 10/9
 Artificial Intelligence Laboratory 6/7,8; 12/13-5
 Electronics Systems Laboratory 6/10
 Crystal Globe 14/11
 Instrumentation Laboratory 2/3,6
 Laboratory for Computer Science 6/11
 Lincoln Laboratories 8/2-11
 LOGO Laboratory 12/15
 Project MAC 6/11; 14/5,11
 Radiation Laboratory 9/5
 Servomechanisms Laboratory 3/13
 Tech Model Railroad Club 6/10; 8/9-10
 Matsumae, Shigeyoshi 14/4
 Mauchly, John 3/6,7; 6/13; 9/6,7
 Max, Nelson 13/5
 McCarthy, John 6/11
 McClelland, William 4/12
 McDivitt, Jim 2/6-7
 McKenzie, John 6/12; 8/1-11; 11/12; 12/13-5
 McIroy, Doug 8/6
 Mead, Carver 13/2-3
 Meyer, Ron 2/9
 Memory 3/14; 7/4-5; 13/10-3
 Acoustic delay line 9/2-4
 Cathode ray tube 3/8,10,13; 13/10
 Core 2/4-5; 3/13; 7/8-9; 9/5; 13/10-3
 Delay line 3/7,9,13; 4/4; 7/4; 13/10
 Direct View Storage Tube 14/10
 Drum 3/10; 5/11; 7/3-4
 Electron Beam Access Memory 10/4
 Electrostatic 2/8
 Magnetic discs 5/5
 Magnetic tape 5/16
 Rope 2/5
 Selectron 5/16; 7/4; 13/10-1
 Semiconductor 5/2, 5-6; 13/13
 Tape (card stock) 4/9
 Thin film 5/5
 Williams tube, see CRT
 Memory Test Computer 7/7,8-9
 Michaels, Charles 9/6
 Microbit Electron Beam Access Memory 10/4
 Micro-code 8/4
 Microprocessor 11/15
 MIDAS debugger 6/7
 Millard, William 13/2-3
 Minicomputers 4/5; 15/5-9
 Minsky, Marvin 6/9; 12/13-5
 MIT, see Japan
 MITRE Corporation 5/8; 15/3
 MITS Altair 9/end bit; 11/9; 14/15
 Mock, Bob 9/6
 MODAC 404 7/7
 Modem
 Anderson Jacobson Acoustic Data Coupler 260 10/7
 Mollala, Arthur 10/3
 Molnar, Charles 1/11
 Monrobot 7/3
 Morello, Fran 9/6
 Morse, Harrison (DIT) 6/5; 8/8-9
 Motorola 2/9
 68000 15/9

Mouse-maze problem 6/8; 8/8
 Multiwire Wiring Machine 6/end bit; 7/12
 Murphy, Francis 4/11
 Murrow Edward R. 2/9
 MUSHASHINO-1 14/3-4
 NAMCO 15/3-5
 NARC (compiler) 14/5
 NASA 2/3-7
 NASA Ames 5/3-6,7
 National Bureau of Standards, see U.S.
 National Cash Register Company 9/9
 National Computer Conference 15/3
 National Physical Laboratory (UK) 3/11
 National Security Agency 9/9
 Naval Tactical Data system (NTDS) 11/8
 NEC Corporation 14/3-6
 DINA (Distributed Information Processing Network Architecture) 14/5
 NARC (compiler) 14/5
 NEAC 1101,2,3 14/3,5
 NEAC 1200 14/3,5
 NEAC 2200,1,2,3 14/3-6
 NEAX-61 14/5
 SENAC-1 14/3,5
 Nelson, Donald 13/8
 Newell, Allen 1/1
 Newell, Martin 11/11
 Newman, Max 3/5; 10/10
 Nippon Telegraph & Telephone (NTT) 14/3
 MUSHASHINO-1 14/3,4
 Nomura, Masanori 15/3-5
 Nook, Charles 5/13

Norden
 Bombsight 5/end bit
 PDP-11/34M 5/9
 Norman, Chuck 8/2
 North American Aviation 2/3
 Nova 2/end bit; 11/6
 Noyce, Robert N. 2/2; 10/13; 11/13-5
 Number sieves 4/2-4
 Oak Ridge National Laboratory 3/8
 O'Connell, Michael 13/9
 O'Donnell, Frank 12/8
 Ohio State University 13/6
 Okazaki, Bunji 14/4
 Olsen, Kenneth H. 1/1; 7/7; 8/2
 ORDVAC 3/6; 7/7
 Osaka University 14/4,5
 Oscilloscope 8/4; 14/10
 Ostby, Eben 13/7
 Otis King Pocket Calculator 8/end bit
 Palesky, Max 7/7
 Palmer, Ralph 9/9,11,12,14
 Papan, William 3/13
 Parametron 14/4
 Pascal, Blaise 1/8; 12/4
 Pascaline 1/8
 Pendrey, Donald 4/12
 Perlis, Alan 7/7; 8/14
 Peterson, Phil 8/2,5
 Pilot ACE 1/13



Pinboard programming 5/11
 Piner, Steve 6/9
 Pipelined computers 5/3
 Pitts, Jim 12/15
 Philco Corporation 9/3; 11/13
 Philco-Ford Corporation 2/3
 Phillips, Charlie 13/8-9
 Planimeter 10/8
 Plug board programming 15/6
 Poduska, John William Sr. 10/2,3; 11/9
 Polish notation 9/14
 Porter, Tom 13/7
 Preliminary Discussions of the Logical Design of an Electronic Computing Instrument 3/8
 Prime 750 15/7
 PDP (Programmed Data Processor) Series
 PDP-1 1/2,3; 6/6-12; 8/3,6,8; 11/12; 12/13-5
 PDP-2 6/8
 PDP-3 6/8; 8/6,10
 PDP-5 15/6-7
 PDP-6 12/15
 PDP-8 1/5; 5/8; 15/6
 PDP-10 5/5
 PDP-11 12/15
 PDP-11/34 5/9
 Programming 7/7
 Prokop, Jan 13/9
 Pugh, Earle W. Jr., 8/5,9
 Punch card data processing 15/10

THE COMPUTER MUSEUM REPORT

NUMBER 10 **FALL 1984**

Individual Founders Charles W. Adams; Elmer R. Adcock; David A. Allen; John Alexander; Kendall Alphin; Gene M. Andelin; Michael and Mary Anderson; Harrison E. and Lois Anderson; Applied Magnetics Corp.; Mr. & Mrs. Roland B. Arnold; Dr. John Anzures; Isaac I. Auerbach; AVX Corporation; Charles and Constance Bachman; John-Loup Bae; Robert W. Bailey, Ph.D.; John Bannock; Jeremy Barker; Steve E. Barshay; Maria S. Barston; John C. Barstow; Isidoro and Risako Baruch; Gordon & Richard Basins; G.C. Baskin, Jr.; C. Gordon & Gwen Bell; James and Roberto Bell; Chester Bell; Alan O. Bell; Whitson Bellville; Dr. Leo L. Benasque; Roger & Kay Berger; Jeffrey Bernstein; Allan M. Bernstein; Gregory C. Bittencourt; James C. Bivitt, Jr.; Britton, Inc.; Dick & Denise Blythe; David B. Block; Elizabeth Bonner; Ted Boren; Alan B. Brady; John C. Brantford; David H. Brinkley; Donald G. Brinkley; Richard A. Brockelman; David A. Brown; Gordon S. Brown; Lawrence C. Brown; Arthur and Alice Byles; James R. Bailey; Max Burnett; Jim & Margaret Butler; Marshall D. Butler; Roger C. Cady; Philip and Betsy Caldwell; Walter M. Carlson; Charles T. & Virginia G. Coale; George A. Chamberlain III; George A. Champlin; Alan Chinnock; Donald Christiansen; Peter Clancy and Carol Peters; Dr. Donald H. Clark; John D. Clarke; Richard J. Clayton; Reginald & Linzer Cleveland; George Towne Clifford; Harold Cohen; William H. Coonley; Charles W. Coombs; Harvey Cropp; Jim Crupchak; Thomas W. Cuddy, Jr.; Henry J. Cussler; James G. Cadmore; Kenneth R. Cunningham; Kent K. Curtis; David N. Cutler; Joe Cychosz; Thomas A. D'Amico; Randall Davis; Chiv E. Dawson; F. de Buss; Ed de Castro; Jean L. de Witgen; M. Armand de Vigny; Nick de Wilt; Anne R. L. Demco; J. Harvey and Barbara Daniel; Gregory Del Sesto; Bruce A. and Frances M. DeLong; Edward L. Demmer; Jack Demmer; Michael L. Detroux; David DeWan; Peter DeWald; Richard Dickerson; Lloyd I. Dickson; John diReggio; J.L. John Doerr; Henri G. Doll; James R. Donahoe; David Donohue; Patrick M. Donohue; George Donohue; Philip H. Donohue; A.S. Douglas; Doug Drane; J. Alvin Drayton; Gray Duckworth; Ray Duncan; Sanford H. Durfee; Joseph E. Eassey; Richard Eckhouse; Professor David S. Edwards; Tom Eggers; M. Gordon Ehrlich; Evans L. Emswiler; Owen E. Emswiler; Joseph E. Emswiler; Richard E. Emswiler; John H. Emswiler; Richard E. Emswiler; Robert H. Emswiler; David Emswiler; Patrick M. Emswiler; George Donohue; Philip H. Donohue; A.S. Douglas; Doug Drane; J. Alvin Drayton; Gray Duckworth; Ray Duncan; Sanford H. Durfee; Joseph E. Eassey; Richard Eckhouse; Professor David S. Edwards; Tom Eggers; M. Gordon Ehrlich; Evans L. Emswiler; Owen E. Emswiler; Joseph E. Emswiler; Richard E. Emswiler; John H. Emswiler; Richard E. Emswiler; Robert H. Emswiler; David Emswiler; Patrick M. Emswiler; George Donohue; Philip H. Donohue; A.S. Douglas; Doug Drane; J. Alvin Drayton; Gray Duckworth; Ray Duncan; Sanford H. Durfee; Joseph E. Eassey; Richard Eckhouse; Professor David S. Edwards; Tom Eggers; M. Gordon Ehrlich; Evans L. Emswiler; Owen E. Emswiler; Joseph E. Emswiler; Richard E. Emswiler; John H. Emswiler; Richard E. Emswiler; Robert H. Emswiler; David Emswiler; Patrick M. Emswiler; George Donohue; Philip H. Donohue; A.S. Douglas; Doug Drane; J. Alvin Drayton; Gray Duckworth; Ray Duncan; Sanford H. Durfee; Joseph E. Eassey; Richard Eckhouse; Professor David S. Edwards; Tom Eggers; M. Gordon Ehrlich; Evans L. Emswiler; Owen E. Emswiler; Joseph E. Emswiler; Richard E. Emswiler; John H. Emswiler; Richard E. Emswiler; Robert H. Emswiler; David Emswiler; Patrick M. Emswiler; George Donohue; Philip H. Donohue; A.S. Douglas; Doug Drane; J. Alvin Drayton; Gray Duckworth; Ray Duncan; Sanford H. Durfee; Joseph E. Eassey; Richard Eckhouse; Professor David S. Edwards; Tom Eggers; M. Gordon Ehrlich; Evans L. Emswiler; Owen E. Emswiler; Joseph E. Emswiler; Richard E. Emswiler; John H. Emswiler; Richard E. Emswiler; Robert H. Emswiler; David Emswiler; Patrick M. Emswiler; George Donohue; Philip H. Donohue; A.S. Douglas; Doug Drane; J. Alvin Drayton; Gray Duckworth; Ray Duncan; Sanford H. Durfee; Joseph E. Eassey; Richard Eckhouse; Professor David S. Edwards; Tom Eggers; M. Gordon Ehrlich; Evans L. Emswiler; Owen E. Emswiler; Joseph E. Emswiler; Richard E. Emswiler; John H. Emswiler; Richard E. Emswiler; Robert H. Emswiler; David Emswiler; Patrick M. Emswiler; George Donohue; Philip H. Donohue; A.S. Douglas; Doug Drane; J. Alvin Drayton; Gray Duckworth; Ray Duncan; Sanford H. Durfee; Joseph E. Eassey; Richard Eckhouse; Professor David S. Edwards; Tom Eggers; M. Gordon Ehrlich; Evans L. Emswiler; Owen E. Emswiler; Joseph E. Emswiler; Richard E. Emswiler; John H. Emswiler; Richard E. Emswiler; Robert H. Emswiler; David Emswiler; Patrick M. Emswiler; George Donohue; Philip H. Donohue; A.S. Douglas; Doug Drane; J. Alvin Drayton; Gray Duckworth; Ray Duncan; Sanford H. Durfee; Joseph E. Eassey; Richard Eckhouse; Professor David S. Edwards; Tom Eggers; M. Gordon Ehrlich; Evans L. Emswiler; Owen E. Emswiler; Joseph E. Emswiler; Richard E. Emswiler; John H. Emswiler; Richard E. Emswiler; Robert H. Emswiler; David Emswiler; Patrick M. Emswiler; George Donohue; Philip H. Donohue; A.S. Douglas; Doug Drane; J. Alvin Drayton; Gray Duckworth; Ray Duncan; Sanford H. Durfee; Joseph E. Eassey; Richard Eckhouse; Professor David S. Edwards; Tom Eggers; M. Gordon Ehrlich; Evans L. Emswiler; Owen E. Emswiler; Joseph E. Emswiler; Richard E. Emswiler; John H. Emswiler; Richard E. Emswiler; Robert H. Emswiler; David Emswiler; Patrick M. Emswiler; George Donohue; Philip H. Donohue; A.S. Douglas; Doug Drane; J. Alvin Drayton; Gray Duckworth; Ray Duncan; Sanford H. Durfee; Joseph E. Eassey; Richard Eckhouse; Professor David S. Edwards; Tom Eggers; M. Gordon Ehrlich; Evans L. Emswiler; Owen E. Emswiler; Joseph E. Emswiler; Richard E. Emswiler; John H. Emswiler; Richard E. Emswiler; Robert H. Emswiler; David Emswiler; Patrick M. Emswiler; George Donohue; Philip H. Donohue; A.S. Douglas; Doug Drane; J. Alvin Drayton; Gray Duckworth; Ray Duncan; Sanford H. Durfee; Joseph E. Eassey; Richard Eckhouse; Professor David S. Edwards; Tom Eggers; M. Gordon Ehrlich; Evans L. Emswiler; Owen E. Emswiler; Joseph E. Emswiler; Richard E. Emswiler; John H. Emswiler; Richard E. Emswiler; Robert H. Emswiler; David Emswiler; Patrick M. Emswiler; George Donohue; Philip H. Donohue; A.S. Douglas; Doug Drane; J. Alvin Drayton; Gray Duckworth; Ray Duncan; Sanford H. Durfee; Joseph E. Eassey; Richard Eckhouse; Professor David S. Edwards; Tom Eggers; M. Gordon Ehrlich; Evans L. Emswiler; Owen E. Emswiler; Joseph E. Emswiler; Richard E. Emswiler; John H. Emswiler; Richard E. Emswiler; Robert H. Emswiler; David Emswiler; Patrick M. Emswiler; George Donohue; Philip H. Donohue; A.S. Douglas; Doug Drane; J. Alvin Drayton; Gray Duckworth; Ray Duncan; Sanford H. Durfee; Joseph E. Eassey; Richard Eckhouse; Professor David S. Edwards; Tom Eggers; M. Gordon Ehrlich; Evans L. Emswiler; Owen E. Emswiler; Joseph E. Emswiler; Richard E. Emswiler; John H. Emswiler; Richard E. Emswiler; Robert H. Emswiler; David Emswiler; Patrick M. Emswiler; George Donohue; Philip H. Donohue; A.S. Douglas; Doug Drane; J. Alvin Drayton; Gray Duckworth; Ray Duncan; Sanford H. Durfee; Joseph E. Eassey; Richard Eckhouse; Professor David S. Edwards; Tom Eggers; M. Gordon Ehrlich; Evans L. Emswiler; Owen E. Emswiler; Joseph E. Emswiler; Richard E. Emswiler; John H. Emswiler; Richard E. Emswiler; Robert H. Emswiler; David Emswiler; Patrick M. Emswiler; George Donohue; Philip H. Donohue; A.S. Douglas; Doug Drane; J. Alvin Drayton; Gray Duckworth; Ray Duncan; Sanford H. Durfee; Joseph E. Eassey; Richard Eckhouse; Professor David S. Edwards; Tom Eggers; M. Gordon Ehrlich; Evans L. Emswiler; Owen E. Emswiler; Joseph E. Emswiler; Richard E. Emswiler; John H. Emswiler; Richard E. Emswiler; Robert H. Emswiler; David Emswiler; Patrick M. Emswiler; George Donohue; Philip H. Donohue; A.S. Douglas; Doug Drane; J. Alvin Drayton; Gray Duckworth; Ray Duncan; Sanford H. Durfee; Joseph E. Eassey; Richard Eckhouse; Professor David S. Edwards; Tom Eggers; M. Gordon Ehrlich; Evans L. Emswiler; Owen E. Emswiler; Joseph E. Emswiler; Richard E. Emswiler; John H. Emswiler; Richard E. Emswiler; Robert H. Emswiler; David Emswiler; Patrick M. Emswiler; George Donohue; Philip H. Donohue; A.S. Douglas; Doug Drane; J. Alvin Drayton; Gray Duckworth; Ray Duncan; Sanford H. Durfee; Joseph E. Eassey; Richard Eckhouse; Professor David S. Edwards; Tom Eggers; M. Gordon Ehrlich; Evans L. Emswiler; Owen E. Emswiler; Joseph E. Emswiler; Richard E. Emswiler; John H. Emswiler; Richard E. Emswiler; Robert H. Emswiler; David Emswiler; Patrick M. Emswiler; George Donohue; Philip H. Donohue; A.S. Douglas; Doug Drane; J. Alvin Drayton; Gray Duckworth; Ray Duncan; Sanford H. Durfee; Joseph E. Eassey; Richard Eckhouse; Professor David S. Edwards; Tom Eggers; M. Gordon Ehrlich; Evans L. Emswiler; Owen E. Emswiler; Joseph E. Emswiler; Richard E. Emswiler; John H. Emswiler; Richard E. Emswiler; Robert H. Emswiler; David Emswiler; Patrick M. Emswiler; George Donohue; Philip H. Donohue; A.S. Douglas; Doug Drane; J. Alvin Drayton; Gray Duckworth; Ray Duncan; Sanford H. Durfee; Joseph E. Eassey; Richard Eckhouse; Professor David S. Edwards; Tom Eggers; M. Gordon Ehrlich; Evans L. Emswiler; Owen E. Emswiler; Joseph E. Emswiler; Richard E. Emswiler; John H. Emswiler; Richard E. Emswiler; Robert H. Emswiler; David Emswiler; Patrick M. Emswiler; George Donohue; Philip H. Donohue; A.S. Douglas; Doug Drane; J. Alvin Drayton; Gray Duckworth; Ray Duncan; Sanford H. Durfee; Joseph E. Eassey; Richard Eckhouse; Professor David S. Edwards; Tom Eggers; M. Gordon Ehrlich; Evans L. Emswiler; Owen E. Emswiler; Joseph E. Emswiler; Richard E. Emswiler; John H. Emswiler; Richard E. Emswiler; Robert H. Emswiler; David Emswiler; Patrick M. Emswiler; George Donohue; Philip H. Donohue; A.S. Douglas; Doug Drane; J. Alvin Drayton; Gray Duckworth; Ray Duncan; Sanford H. Durfee; Joseph E. Eassey; Richard Eckhouse; Professor David S. Edwards; Tom Eggers; M. Gordon Ehrlich; Evans L. Emswiler; Owen E. Emswiler; Joseph E. Emswiler; Richard E. Emswiler; John H. Emswiler; Richard E. Emswiler; Robert H. Emswiler; David Emswiler; Patrick M. Emswiler; George Donohue; Philip H. Donohue; A.S. Douglas; Doug Drane; J. Alvin Drayton; Gray Duckworth; Ray Duncan; Sanford H. Durfee; Joseph E. Eassey; Richard Eckhouse; Professor David S. Edwards; Tom Eggers; M. Gordon Ehrlich; Evans L. Emswiler; Owen E. Emswiler; Joseph E. Emswiler; Richard E. Emswiler; John H. Emswiler; Richard E. Emswiler; Robert H. Emswiler; David Emswiler; Patrick M. Emswiler; George Donohue; Philip H. Donohue; A.S. Douglas; Doug Drane; J. Alvin Drayton; Gray Duckworth; Ray Duncan; Sanford H. Durfee; Joseph E. Eassey; Richard Eckhouse; Professor David S. Edwards; Tom Eggers; M. Gordon Ehrlich; Evans L. Emswiler; Owen E. Emswiler; Joseph E. Emswiler; Richard E. Emswiler; John H. Emswiler; Richard E. Emswiler; Robert H. Emswiler; David Emswiler; Patrick M. Emswiler; George Donohue; Philip H. Donohue; A.S. Douglas; Doug Drane; J. Alvin Drayton; Gray Duckworth; Ray Duncan; Sanford H. Durfee; Joseph E. Eassey; Richard Eckhouse; Professor David S. Edwards; Tom Eggers; M. Gordon Ehrlich; Evans L. Emswiler; Owen E. Emswiler; Joseph E. Emswiler; Richard E. Emswiler; John H. Emswiler; Richard E. Emswiler; Robert H. Emswiler; David Emswiler; Patrick M. Emswiler; George Donohue; Philip H. Donohue; A.S. Douglas; Doug Drane; J. Alvin Drayton; Gray Duckworth; Ray Duncan; Sanford H. Durfee; Joseph E. Eassey; Richard Eckhouse; Professor David S. Edwards; Tom Eggers; M. Gordon Ehrlich; Evans L. Emswiler; Owen E. Emswiler; Joseph E. Emswiler; Richard E. Emswiler; John H. Emswiler; Richard E. Emswiler; Robert H. Emswiler; David Emswiler; Patrick M. Emswiler; George Donohue; Philip H. Donohue; A.S. Douglas; Doug Drane; J. Alvin Drayton; Gray Duckworth; Ray Duncan; Sanford H. Durfee; Joseph E. Eassey; Richard Eckhouse; Professor David S. Edwards; Tom Eggers; M. Gordon Ehrlich; Evans L. Emswiler; Owen E. Emswiler; Joseph E. Emswiler; Richard E. Emswiler; John H. Emswiler; Richard E. Emswiler; Robert H. Emswiler; David Emswiler; Patrick M. Emswiler; George Donohue; Philip H. Donohue; A.S. Douglas; Doug Drane; J. Alvin Drayton; Gray Duckworth; Ray Duncan; Sanford H. Durfee; Joseph E. Eassey; Richard Eckhouse; Professor David S. Edwards; Tom Eggers; M. Gordon Ehrlich; Evans L. Emswiler; Owen E. Emswiler; Joseph E. Emswiler; Richard E. Emswiler; John H. Emswiler; Richard E. Emswiler; Robert H. Emswiler; David Emswiler; Patrick M. Emswiler; George Donohue; Philip H. Donohue; A.S. Douglas; Doug Drane; J. Alvin Drayton; Gray Duckworth; Ray Duncan; Sanford H. Durfee; Joseph E. Eassey; Richard Eckhouse; Professor David S. Edwards; Tom Eggers; M. Gordon Ehrlich; Evans L. Emswiler; Owen E. Emswiler; Joseph E. Emswiler; Richard E. Emswiler; John H. Emswiler; Richard E. Emswiler; Robert H. Emswiler; David Emswiler; Patrick M. Emswiler; George Donohue; Philip H. Donohue; A.S. Douglas; Doug Drane; J. Alvin Drayton; Gray Duckworth; Ray Duncan; Sanford H. Durfee; Joseph E. Eassey; Richard Eckhouse; Professor David S. Edwards; Tom Eggers; M. Gordon Ehrlich; Evans L. Emswiler; Owen E. Emswiler; Joseph E. Emswiler; Richard E. Emswiler; John H. Emswiler; Richard E. Emswiler; Robert H. Emswiler; David Emswiler; Patrick M. Emswiler; George Donohue; Philip H. Donohue; A.S. Douglas; Doug Drane; J. Alvin Drayton; Gray Duckworth; Ray Duncan; Sanford H. Durfee; Joseph E. Eassey; Richard Eckhouse; Professor David S. Edwards; Tom Eggers; M. Gordon Ehrlich; Evans L. Emswiler; Owen E. Emswiler; Joseph E. Emswiler; Richard E. Emswiler; John H. Emswiler; Richard E. Emswiler; Robert H. Emswiler; David Emswiler; Patrick M. Emswiler; George Donohue; Philip H. Donohue; A.S. Douglas; Doug Drane; J. Alvin Drayton; Gray Duckworth; Ray Duncan; Sanford H. Durfee; Joseph E. Eassey; Richard Eckhouse; Professor David S. Edwards; Tom Eggers; M. Gordon Ehrlich; Evans L. Emswiler; Owen E. Emswiler; Joseph E. Emswiler; Richard E. Emswiler; John H. Emswiler; Richard E. Emswiler; Robert H. Emswiler; David Emswiler; Patrick M. Emswiler; George Donohue; Philip H. Donohue; A.S. Douglas; Doug Drane; J. Alvin Drayton; Gray Duckworth; Ray Duncan; Sanford H. Durfee; Joseph E. Eassey; Richard Eckhouse; Professor David S. Edwards; Tom Eggers; M. Gordon Ehrlich; Evans L. Emswiler; Owen E. Emswiler; Joseph E. Emswiler; Richard E. Emswiler; John H. Emswiler; Richard E. Emswiler; Robert H. Emswiler; David Emswiler; Patrick M. Emswiler; George Donohue; Philip H. Donohue; A.S. Douglas; Doug Drane; J. Alvin Drayton; Gray Duckworth; Ray Duncan; Sanford H. Durfee; Joseph E. Eassey; Richard Eckhouse; Professor David S. Edwards; Tom Eggers; M. Gordon Ehrlich; Evans L. Emswiler; Owen E. Emswiler; Joseph E. Emswiler; Richard E. Emswiler; John H. Emswiler; Richard E. Emswiler; Robert H. Emswiler; David Emswiler; Patrick M. Emswiler; George Donohue; Philip H. Donohue; A.S. Douglas; Doug Drane; J. Alvin Drayton; Gray Duckworth; Ray Duncan; Sanford H. Durfee; Joseph E. Eassey; Richard Eckhouse; Professor David S. Edwards; Tom Eggers; M. Gordon Ehrlich; Evans L. Emswiler; Owen E. Emswiler; Joseph E. Emswiler; Richard E. Emswiler; John H. Emswiler; Richard E. Emswiler; Robert H. Emswiler; David Emswiler; Patrick M. Emswiler; George Donohue; Philip H. Donohue; A.S. Douglas; Doug Drane; J. Alvin Drayton; Gray Duckworth; Ray Duncan; Sanford H. Durfee; Joseph E. Eassey; Richard Eckhouse; Professor David S. Edwards; Tom Eggers; M. Gordon Ehrlich; Evans L. Emswiler; Owen E. Emswiler; Joseph E. Emswiler; Richard E. Emswiler; John H. Emswiler; Richard E. Emswiler; Robert H. Emswiler; David Emswiler; Patrick M. Emswiler; George Donohue; Philip H. Donohue; A.S. Douglas; Doug Drane; J. Alvin Drayton; Gray Duckworth; Ray Duncan; Sanford H. Durfee; Joseph E. Eassey; Richard Eckhouse; Professor David S. Edwards; Tom Eggers; M. Gordon Ehrlich; Evans L. Emswiler; Owen E. Emswiler; Joseph E. Emswiler; Richard E. Emswiler; John H. Emswiler; Richard E. Emswiler; Robert H. Emswiler; David Emswiler; Patrick M. Emswiler; George Donohue; Philip H. Donohue; A.S. Douglas; Doug Drane; J. Alvin Drayton; Gray Duckworth; Ray Duncan; Sanford H. Durfee; Joseph E. Eassey; Richard Eckhouse; Professor David S. Edwards; Tom Eggers; M. Gordon Ehrlich; Evans L. Emswiler; Owen E. Emswiler; Joseph E. Emswiler; Richard E. Emswiler; John H. Emswiler; Richard E. Emswiler; Robert H. Emswiler; David Emswiler; Patrick M. Emswiler; George Donohue; Philip H. Donohue; A.S. Douglas; Doug Drane; J. Alvin Drayton; Gray Duckworth; Ray Duncan; Sanford H. Durfee; Joseph E. Eassey; Richard Eckhouse; Professor David S. Edwards; Tom Eggers; M. Gordon Ehrlich; Evans L. Emswiler; Owen E. Emswiler; Joseph E. Emswiler; Richard E. Emswiler; John H. Emswiler; Richard E. Emswiler; Robert H. Emswiler; David Emswiler; Patrick M. Emswiler; George Donohue; Philip H. Donohue; A.S. Douglas; Doug Drane; J. Alvin Drayton; Gray Duckworth; Ray Duncan; Sanford H. Durfee; Joseph E. Eassey; Richard Eckhouse; Professor David S. Edwards; Tom Eggers; M. Gordon Ehrlich; Evans L. Emswiler; Owen E. Emswiler; Joseph E. Emswiler; Richard E. Emswiler; John H. Emswiler; Richard E. Emswiler; Robert H. Emswiler; David Emswiler; Patrick M. Emswiler; George Donohue; Philip H. Donohue; A.S. Douglas; Doug Drane; J. Alvin Drayton; Gray Duckworth; Ray Duncan; Sanford H. Durfee; Joseph E. Eassey; Richard Eckhouse; Professor David S. Edwards; Tom Eggers; M. Gordon Ehrlich; Evans L. Emswiler; Owen E. Emswiler; Joseph E. Emswiler; Richard E. Emswiler; John H. Emswiler; Richard E. Emswiler; Robert H. Emswiler; David Emswiler; Patrick M. Emswiler; George Donohue; Philip H. Donohue; A.S. Douglas; Doug Drane; J. Alvin Drayton; Gray Duckworth; Ray Duncan; Sanford H. Durfee; Joseph E. Eassey; Richard Eckhouse; Professor David S. Edwards; Tom Eggers; M. Gordon Ehrlich; Evans L. Emswiler; Owen E. Emswiler; Joseph E. Emswiler; Richard E. Emswiler; John H. Emswiler; Richard E. Emswiler; Robert H. Emswiler; David Emswiler; Patrick M. Emswiler; George Donohue; Philip H. Donohue; A.S. Douglas; Doug Drane; J. Alvin Drayton; Gray Duckworth; Ray Duncan; Sanford H. Durfee; Joseph E. Eassey; Richard Eckhouse; Professor David S. Edwards; Tom Eggers; M. Gordon Ehrlich; Evans L. Emswiler; Owen E. Emswiler; Joseph E. Emswiler; Richard E. Emswiler; John H. Emswiler; Richard E. Emswiler; Robert H. Emswiler; David Emswiler; Patrick M. Emswiler; George Donohue; Philip H. Donohue; A.S. Douglas; Doug Drane; J. Alvin Drayton; Gray Duckworth; Ray Duncan; Sanford H. Durfee; Joseph E. Eassey; Richard Eckhouse; Professor David S. Edwards; Tom Eggers; M. Gordon Ehrlich; Evans L. Emswiler; Owen E. Emswiler; Joseph E. Emswiler; Richard E. Emswiler; John H. Emswiler; Richard E. Emswiler; Robert H. Emswiler; David Emswiler; Patrick M. Emswiler; George Donohue; Philip H. Donohue; A.S. Douglas; Doug Drane; J. Alvin Drayton; Gray Duckworth; Ray Duncan; Sanford H. Durfee; Joseph E. Eassey; Richard Eckhouse; Professor David S. Edwards; Tom Eggers; M. Gordon Ehrlich; Evans L. Emswiler; Owen E. Emswiler; Joseph E. Emswiler; Richard E. Emswiler; John H. Emswiler; Richard E. Emswiler; Robert H. Emswiler; David Emswiler; Patrick M. Emswiler; George Donohue; Philip H. Donohue; A.S. Douglas; Doug Drane; J. Alvin Drayton; Gray Duckworth; Ray Duncan; Sanford H. Durfee; Joseph E. Eassey; Richard Eckhouse; Professor David S. Edwards; Tom Eggers; M. Gordon Ehrlich; Evans L. Emswiler; Owen E. Emswiler; Joseph E. Emswiler; Richard E. Emswiler; John H. Emswiler; Richard E. Emswiler; Robert H. Emswiler; David Emswiler; Patrick M. Emswiler; George Donohue; Philip H. Donohue; A.S. Douglas; Doug Drane; J. Alvin Drayton; Gray Duckworth; Ray Duncan; Sanford H. Durfee; Joseph E. Eassey; Richard Eckhouse; Professor David S. Edwards; Tom Eggers; M. Gordon Ehrlich; Evans L. Emswiler; Owen E. Emswiler; Joseph E. Emswiler; Richard E. Emswiler; John H. Emswiler; Richard E. Emswiler; Robert H. Emswiler; David Emswiler; Patrick M. Emswiler; George Donohue; Philip H. Donohue; A.S. Douglas; Doug Drane; J. Alvin Drayton; Gray Duckworth; Ray Duncan; Sanford H. Durfee; Joseph E. Eassey; Richard Eckhouse; Professor David S. Edwards; Tom Eggers; M. Gordon Ehrlich; Evans L. Emswiler; Owen E. Emswiler; Joseph E. Emswiler; Richard E. Emswiler; John H. Emswiler; Richard E. Emswiler; Robert H. Emswiler; David Emswiler; Patrick M. Emswiler; George Donohue; Philip H. Donohue; A.S. Douglas; Doug Drane; J. Alvin Drayton; Gray Duckworth; Ray Duncan; Sanford H. Durfee; Joseph E. Eassey; Richard Eckhouse; Professor David S. Edwards; Tom Eggers; M. Gordon Ehrlich; Evans L. Emswiler; Owen E. Emswiler; Joseph E. Emswiler; Richard E. Emswiler; John H. Emswiler; Richard E. Emswiler; Robert H. Emswiler; David Emswiler; Patrick M. Emswiler; George Donohue; Philip H. Donohue; A.S. Douglas; Doug Drane; J. Alvin Drayton; Gray Duckworth; Ray Duncan; Sanford H. Durfee; Joseph E. Eassey; Richard Eckhouse; Professor David S. Edwards; Tom Eggers; M. Gordon Ehrlich; Evans L. Emswiler; Owen E. Emswiler; Joseph E. Emswiler; Richard E. Emswiler; John H. Emswiler; Richard E. Emswiler; Robert H. Emswiler; David Emswiler; Patrick M. Emswiler; George Donohue; Philip H. Donohue; A.S. Douglas; Doug Drane; J. Alvin Drayton; Gray Duckworth; Ray Duncan; Sanford H. Durfee; Joseph E. Eassey; Richard Eckhouse; Professor David S. Edwards; Tom Eggers; M. Gordon Ehrlich; Evans L. Emswiler; Owen E. Emswiler; Joseph E. Emswiler; Richard E. Emswiler; John H. Emswiler; Richard E. Emswiler; Robert H. Emswiler; David Emswiler; Patrick M. Emswiler; George Donohue; Philip H. Donohue; A.S. Douglas; Doug Drane; J. Alvin Drayton; Gray Duckworth; Ray Duncan; Sanford H. Durfee; Joseph E. Eassey; Richard Eckhouse; Professor David S. Edwards; Tom Eggers; M. Gordon Ehrlich; Evans L. Emswiler; Owen E. Emswiler; Joseph E. Emswiler; Richard E. Emswiler; John H. Emswiler; Richard E. Emswiler; Robert H. Emswiler; David Emswiler; Patrick M. Emswiler; George Donohue; Philip H. Donohue; A.S. Douglas; Doug Drane; J. Alvin Drayton; Gray Duckworth; Ray Duncan; Sanford H. Durfee; Joseph E. Eassey; Richard Eckhouse; Professor David S. Edwards; Tom Eggers; M. Gordon Ehrlich; Evans L. Emswiler; Owen E. Emswiler; Joseph E. Emswiler; Richard E. Emswiler; John H. Emswiler; Richard E. Emswiler; Robert H. Emswiler; David Emswiler; Patrick M. Emswiler; George Donohue; Philip H. Donohue; A.S. Douglas; Doug Drane; J. Alvin Drayton; Gray Duckworth; Ray Duncan; Sanford H. Durfee; Joseph E. Eassey; Richard Eckhouse; Professor David S. Edwards; Tom Eggers; M. Gordon Ehrlich; Evans L. Emswiler; Owen E. Emswiler; Joseph E. Emswiler; Richard E. Emswiler; John H. Emswiler; Richard E. Emswiler; Robert H. Emswiler; David Emswiler; Patrick M. Emswiler; George Donohue; Philip H. Donohue; A.S. Douglas; Doug Drane; J. Alvin Drayton; Gray Duckworth; Ray Duncan; Sanford H. Durfee; Joseph E. Eassey; Richard Eckhouse; Professor David S. Edwards; Tom Eggers; M. Gordon Ehrlich; Evans L. Emswiler; Owen E. Emswiler; Joseph E. Emswiler; Richard E. Emswiler; John H. Emswiler; Richard E. Emswiler; Robert H. Emswiler; David Emswiler; Patrick M. Emswiler; George Donohue; Philip H. Donohue; A.S. Douglas; Doug Drane; J. Alvin Drayton; Gray Duckworth; Ray Duncan; Sanford H. Durfee; Joseph E. Eassey; Richard Eckhouse; Professor David S. Edwards; Tom Eggers; M. Gordon Ehrlich; Evans L. Emswiler; Owen E. Emswiler; Joseph E. Emswiler; Richard E. Emswiler; John H. Emswiler; Richard E. Emswiler; Robert H. Emswiler; David Emswiler; Patrick M. Emswiler; George Donohue; Philip H. Donohue; A.S. Douglas; Doug Drane; J. Alvin Drayton; Gray Duckworth; Ray Duncan; Sanford H. Durfee; Joseph E. Eassey; Richard Eckhouse; Professor David S. Edwards; Tom Eggers; M. Gordon Ehrlich; Evans L. Emswiler; Owen E. Emswiler; Joseph E. Emswiler; Richard E. Emswiler; John H. Emswiler; Richard E. Emswiler; Robert H. Emswiler; David Emswiler; Patrick M. Emswiler; George Donohue; Philip H. Donohue; A.S. Douglas; Doug Drane; J. Alvin Drayton; Gray Duckworth; Ray Duncan; Sanford H. Durfee; Joseph E. Eassey; Richard Eckhouse; Professor David S. Edwards; Tom Eggers; M. Gordon Ehrlich; Evans L. Emswiler; Owen E. Emswiler; Joseph E. Emswiler; Richard E. Emswiler; John H. Emswiler; Richard E. Emswiler; Robert H. Emswiler; David Emswiler; Patrick M. Emswiler; George Donohue; Philip H. Donohue; A.S. Douglas; Doug Drane; J. Alvin Drayton; Gray Duckworth; Ray Duncan; Sanford H. Durfee; Joseph E. Eassey; Richard Eckhouse; Professor David S. Edwards; Tom Eggers; M. Gordon Ehrlich; Evans L. Emswiler; Owen E. Emswiler; Joseph E. Emswiler; Richard E. Emswiler; John H. Emswiler; Richard E. Emswiler; Robert H. Emswiler; David Emswiler; Patrick M. Emswiler; George Donohue; Philip H. Donohue; A.S. Douglas; Doug Drane; J. Alvin Drayton; Gray Duckworth; Ray Duncan; Sanford H. Durfee; Joseph E. Eassey; Richard Eckhouse; Professor David S. Edwards; Tom Eggers; M. Gordon Ehrlich; Evans L. Emswiler; Owen E. Emswiler; Joseph E. Emswiler; Richard E. Emswiler; John H. Emswiler; Richard E. Emswiler; Robert H. Emswiler; David Emswiler; Patrick M. Emswiler; George Donohue; Philip H. Donohue; A.S. Douglas; Doug Drane; J. Alvin Drayton; Gray Duckworth; Ray Duncan; Sanford H. Durfee; Joseph E. Eassey; Richard Eckhouse; Professor David S. Edwards; Tom Eggers; M. Gordon Ehrlich; Evans L. Emswiler; Owen E. Emswiler; Joseph E. Emswiler; Richard E. Emswiler; John H. Emswiler; Richard E. Emswiler; Robert H. Emswiler; David Emswiler; Patrick M. Emswiler; George Donohue; Philip H. Donohue; A.S. Douglas; Doug Drane; J. Alvin Drayton; Gray Duckworth; Ray Duncan; Sanford H. Durfee; Joseph E. Eassey; Richard Eckhouse; Professor David S. Edwards; Tom Eggers; M. Gordon Ehrlich; Evans L. Emswiler; Owen E. Emswiler; Joseph E. Emswiler; Richard E. Emswiler; John H. Emswiler; Richard E. Emswiler; Robert H. Emswiler; David Emswiler; Patrick M. Emswiler; George Donohue; Philip H. Donohue; A.S. Douglas; Doug Drane; J. Alvin Drayton; Gray Duckworth; Ray Duncan; Sanford H. Durfee; Joseph E. Eassey; Richard Eckhouse; Professor David S. Edwards; Tom Eggers; M. Gordon Ehrlich; Evans L. Emswiler; Owen E. Emswiler; Joseph E. Emswiler; Richard E. Emswiler; John H. Emswiler; Richard E. Emswiler; Robert H. Emswiler; David Emswiler; Patrick M. Emswiler; George Donohue; Philip H. Donohue; A.S. Douglas; Doug Drane; J. Alvin Drayton; Gray Duckworth; Ray Duncan; Sanford H. Durfee; Joseph E. Eassey; Richard Eckhouse; Professor David S. Edwards; Tom Eggers; M. Gordon Ehrlich; Evans L. Emswiler; Owen E. Emswiler; Joseph E. Emswiler; Richard E. Emswiler; John H. Emswiler; Richard E. Emswiler; Robert H. Emswiler; David Emswiler; Patrick M. Emswiler; George Donohue; Philip H. Donohue; A.S. Douglas; Doug Drane; J. Alvin Drayton; Gray Duckworth; Ray Duncan; Sanford H. Durfee; Joseph E. Eassey; Richard Eckhouse; Professor David S. Edwards; Tom Eggers; M. Gordon Ehrlich; Evans L. Emswiler; Owen E.

bie, I.I. 4/11
 Alwigen, John 11/8
 Rony, Peter 15/3,4
 Rosen, Saul 5/11
 Roenbaum, Susan 15/5
 Ross, Doug 6/5,8; 8/8-9,10; 10/9
 Rotenberg, Jonathan 13/2-3
 Russell, Steve "Slug" 6/7-12, 9; 12/13-5
 Rutherford Laboratories 13/4

S

SAGE System 4/13-4, 14/16 see also AN/FS Q-7
 Salesin David 13/7
 Sampson, Peter 6/8-12
 Sanders Corporation 12/15
 Saunders, Robert 6/7-12
 Scelbi Computer Consulting Inc 14/8
 Scelbi 8H 14/8
 Schreier, Helmut 3/4
 Schreine, Ned 9/6
 Schweickart, Rusty 2/6-7
 Schulz, Stan 8/11; 11/12
 Science Museum, Ueno 14/4
 Scientific Data Systems (SDS) 15/6
 Scott, David 2/6-7
 Scripnel Corp., Transparent Digitizing Tablet 14/11
 SDS-910, 920 15/6
 SEAC (Standards Eastern Automatic Computer) 3/12, 14-15; 7/3,5
 Seeber, Rex 4/10
 Selectron tube, see memory
 Selridge, Oliver 5/19
 Semiconductor diodes 9/3-5
 Semiconductor industry 11/13-5
 Semiconductors 2/2; 11/13-5; 14/4,5; 15/7,8
 Shannon, Claude mouse 8/8
 Shopley, Howard 12/4,5,7
 Shaw, Bob 9/3,6
 Shepard, Brad 9/6
 Shinohara, Noboru 14/4
 Sims, John 9/6
 Sinclair ZX-80 14/9
 Sinclair ZX-81 14/9
 Sinclair, Sir Clive 14/9
 Slide rules, circular 5/14-5
 Slotnick, Daniel 5/3-6
 Smith, Alvy Ray 13/7
 Smith, Edward E. 6/7
 Smith, Mary Norton 4/10
 Smolar, Gerry 9/6
 Smoot, Oliver 13/9
Snoot and Mully 13/6
 Snyder, Betty 9/6
 Snyder, James 7/2
 SOAP 7/7
 Software definition 7/10-2
 SpaceWar! 1/2; 6/6-12; 8/10; 11/12
 Speech synthesis 8/8-9
 SPEEDCODE 7/7
 Sperry Corporation
 Sperry Rand 9/5
 Sperry Univac
 NTDS (Naval Tactical Data System) 11/8
 Stad, Ben 9/6
 Stahlman, Richard 12/13-5
 Stanford University 12/15
 Stockham, Thomas 6/7; 8/6
 Stevens, Kenneth 8/5, 8; 12/14
 Stibitz, George 1/12; 3/2,3
 Stall, Reed 6/13
 Stored program concept 1/13; 3/3,5,6,7,8
 Stratus Computer Corporation 15/8
 Stratus Computer 15/8
 Strimpel, Oliver 15/5
 Stromberg-Carlson 4020 12/4
 Subroutines 2/8; 15/11
 Supercomputers 5/3-7

Survey of Domestic Electronic Digital Computing Systems 1955 5/3-7
 Sutherland, Jim 14/end bit
 SWAC (Standards Western Automatic Computer) 3/12, 14-5
 Switzerland 15/3
 Symbol 5/10
 Syracuse University 4/10

THE COMPUTER MUSEUM REPORT



T

Tabulating Machine Company 9/9
 TAC (Tokyo University Automatic Computer) 14/3,4
 Takahashi, Hidetoshi 14/4
 Tandem Computer Corporation 15/8-9
 Tandy Radio Shack Corporation 10/5
 Tashiro, Hirofumi 15/3-5
 Tech Model Railroad Club see MIT
 Tektronix Model 564 oscilloscope 14/10
 Telecommunications 14/3-6
 Teletype 3/2; 15/6,13
 tape 14/15
 Telex Corporation 9/16
 Teller, Edward 4/11; 9/12-3
 Texas Instruments 2/3; 5/3
 Speak and Spell 5/12
 Thomas, L.H. 4/11, 12, 15
 Thompson, Joe 2/8,9
 Thornton, James 11/8
 Tic-tac-toe 6/8
 Timesharing 8/10; 9/16; 14/5, 11, 13
 Timex/Sinclair 100 14/9
 Tohoku University 14/5
 Tokyo University 14/4
 PC-1.2 14/3,4
Tomorrow: The Thinking Machine 6/5
 Toshiba Corp 14/4
 Townsend, Ed 5/8
 Transistor 1/6; 2/2; 8/7; 11/13; 14/4,5
 Troxel, Dan 8/8
 TRS-80 10/5; 14/9
 TX-0 1/1-2; 6/5,7-8; 8/1-11; 12/13-4
 TX-1 8/6
 TX-2 8/4,5,7
 Turing, Alan 1/13; 3/5,11

U

UK 15/2-5
 Underwood Corp 14/12
 Underwood, Fran 9/11
 U.S. Army
 Aberdeen Proving Grounds 3/6; 7/7; 12/10

U.S. Bureau of Standards 6/13
 see also SEAC, SWAC
 U.S. Navy 3/3; 12/3
 Naval Mine Warfare School 12/5
 Naval Observatory 4/8
 Naval Proving Grounds, Dahlgren 7/8; 12/9
 Office of Naval Research 3/13
 U. S. Social Security Act 9/9
 USSR Government Minsk 2 logic board 10/6
 UNIX 12/15
 Univac Corporation 5/7
 LARC 6/13; 9/12-3
 NTDS CP-642 5/7; 11/8
 Uniservo 6/12
 1 4/11; 6/13; 5/16; 7/4,5,7; 9/3; 11/6; 12/11; 13/8
 1100 9/12-3
 1105 13/8
 University of California, Berkeley 4/4
 University of Illinois 3/8; 5/3-6
 University of Michigan 14/7
 MIDAC 7/7
 University of Pennsylvania, Army Ballistic Research Laboratory 3/6
 Moore School of Electrical Engineering 3/7; 5/11; 6/13; 13/10; 15/11

V

Vacuum tubes 3/7,12; 4/2,9; 7/3-7; 8/7; 9/3; 11/5; 13/10
 van Baerle, Susan 13/6
 van Dam, Andries 8/15
 VAX 8/1; 11/5,10,11; 12/15; 13/7
 Vector graphics 14/10
 Video archives 6/3-5
 Voice recognition 8/4
 Vol Libre 12/5
 Von Neumann, John 3/7,8; 7/4,7; 9/10; 13/10,13
 Von Reppert Calculating Machine 14/12
 Von Reppert, Richard 14/12

W

Wada, Hiroshi 14/5
 Wadsworth, Nat 14/8
 Walker, Robert 6/11
 Wang, An 7/7; 9/5; 10/2-3
 Ward, John 6/8; 8/8; 14/11
 Watanabe, Hitoshi 14/4
 Watson, Thomas Jr., 9/10,11,13,18; 12/6
 Watson, Thomas Sr., 4/8-12; 9/9; 12/3,5,6,7
 Wayne State University 7/5
 UDEC #2 5/11
 Webb Adder 14/13
 Wedilog 7/7
 Weik, Martin 7/3
 Weiner, Jim 9/3,7
 Weiner, Norbert 12/7
 Weizenbaum, Joseph 4/15; 7/7
 Welch, Frazer 9/6
 Wendell, Doug 9/6
 West Germany 15/2
 West, Tom 4/5-7
 Western Electric 9/3
 Westinghouse Electric 5/4
 semiconductor flatpacks 15/7
 Wheeler, David 10/10
 Whirlwind 2/8-9; 3/12,13,14-5; 4/13; 6/7,8; 7/4,6; 8/9; 11/4; 15/12
 White, Derwood 12/8
 Wiitanen, Wayne 6/7
 Wilkes, Maurice 1/12,13; 3/9, end bit; 5/18; 7/7; 9/3,7,10,16; 10/10; 13/2-3,10; 15/11

Wilkinson, James 1/13; 3/11; 10/10
 Williams, Al 9/18
 Williams, F.C. 1/13; 3/5,10,12; 10/10
 Wilson, Lou 9/6
 Winsor, Paul 9/6
 WISC 7/7
 Woodbury, Bill 4/11
 Woodfield, David 15/3
 Woodger, Mike 4/14
 World Micromouse Contest, World Expo, Tsukuba City 15/3

X

Xerox Corporation 15/6
 Xerox PARC Alto 5/18

Y

Yamashita, Hideo 14/4
 Yarnell, Gail 7/13

Z

Zajac, Ed 13/4
 Zilog Z80 15/3
 Z80A 14/9
 Zingg, Ray 5/10
 Zuse, Konrad 1/12; 3/3; 7/3; 10/10
 1/4,12; 3/3,14-5 Z-2-4 3/3

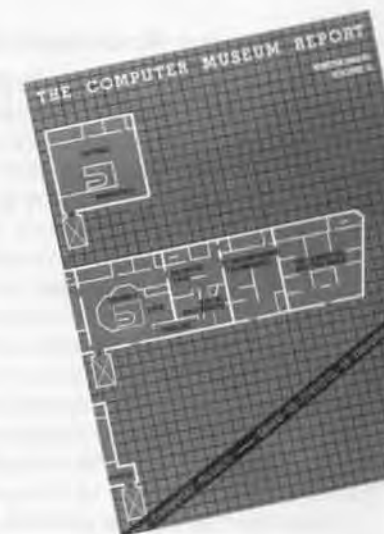

Colors of Chaos

A Special Exhibit
April 11-September 8
1986

Oliver Strimpel

The pictures of Colors of Chaos are the result of using computer graphics as a tool for research in complex dynamics, a branch of mathematics and physics. The goal is to understand what happens to simple mathematical formulae when they are iterated.

The pictures are built up in the following way: each point is iterated using the mathematical formula under investigation. For example, if the formula is the trigonometrical function cosine, this corresponds to entering the number corresponding to a point in the picture into a calculator, and pressing the cosine button again and again. The point in the picture is then colored depending on what happens. In some of the pictures, the color shows how quickly the point "escapes" to infinity, leaving black those points that never escape. In others, the colors show where points end up under iteration, with the shades indicating how quickly they get there. Thus the colors represent the dynamics of the iteration.

Julia Sets and Mandelbrot Sets

Two types of picture can represent the iterative process. In the Julia set, the initial value of the complex number at the start of the iteration is varied over the plane. The parameters of the iteration are fixed. A point is in the set if it lies on the boundary of the points that become larger and larger as the iteration proceeds. Each set of parameters creates a whole different Julia set. One of the remarkable discoveries revealed in Robert Devaney's images is that the Julia set can change dramatically, even evaporate completely, for very small changes in the parameters of the iteration. The picture shown on the front cover is a still image from a film showing the dramatic change in the structure of the Julia set for the sine function as the parameter is varied. The black region shows points that have not escaped to infinity after 35 iterations, while the colored regions show escaped points. Red points tend to infinity the fastest, followed by points colored in orange, yellow, green, blue and violet.

The Mandelbrot set is an example of the second type of picture. Here, it is the value of the parameter that is varied over the plane and the initial value of the complex number is

set to zero everywhere. Each formula being iterated has only one of these pictures. A point is a member of the set if it never escapes to infinity under iteration.

The first formula investigated by Benoit Mandelbrot in 1975 was simply the squaring of the complex number in which one iteration step consists of squaring the number and adding a constant. By varying this constant over the plane as the parameter, Mandelbrot discovered a cardioid shaped set with a hairy boundary—the Mandelbrot set. To the mathematicians' surprise, this shape appears to be universal in that it crops up, albeit somewhat modified in detail, when many other formulae are iterated. When the boundary of the Mandelbrot set is examined in fine detail, baroque swirls, spirals and tendrils appear, including some that lead to offshoots containing smaller replicas of the Mandelbrot set itself. It is this fascinating structure at the boundary of the Mandelbrot set that is vividly represented in the Colors of Chaos images that came from the Bremen group.

Julia sets and Mandelbrot sets can take a lot of computing. Firstly, each point of the picture has to be iterated separately (unless one uses a parallel machine), so the time taken to create an image is proportional to the total number of pixels computed. Secondly, the number of iteration steps required per point can be as high as several thousand. The closer to the boundary of the Mandelbrot or Julia set you go, the longer it takes a point to 'make up its mind' as to where it is really attracted. Each iteration step takes several floating point multiplies or the evaluation of a trigonometrical function. Robert Devaney has just used 72 hours of the Cray supercomputer at Digital Productions to make a new spectacular film showing Julia sets of cosine. It will be added to the video showing in the exhibit.

Images in the Colors of Chaos Exhibit

A series of twelve pictures shows Julia Sets and Mandelbrot Sets generated by the iteration of polynomial functions and ratios thereof by a team from the University of Bremen led by Heinz-Otto Peitgen and Peter Richter.

A second series shows Julia sets of sine, cosine and the exponential



function by Robert L. Devaney from the Department of Mathematics at Boston University.

Why do this?

Because it's there! The beauty of the images continues to spur along ever

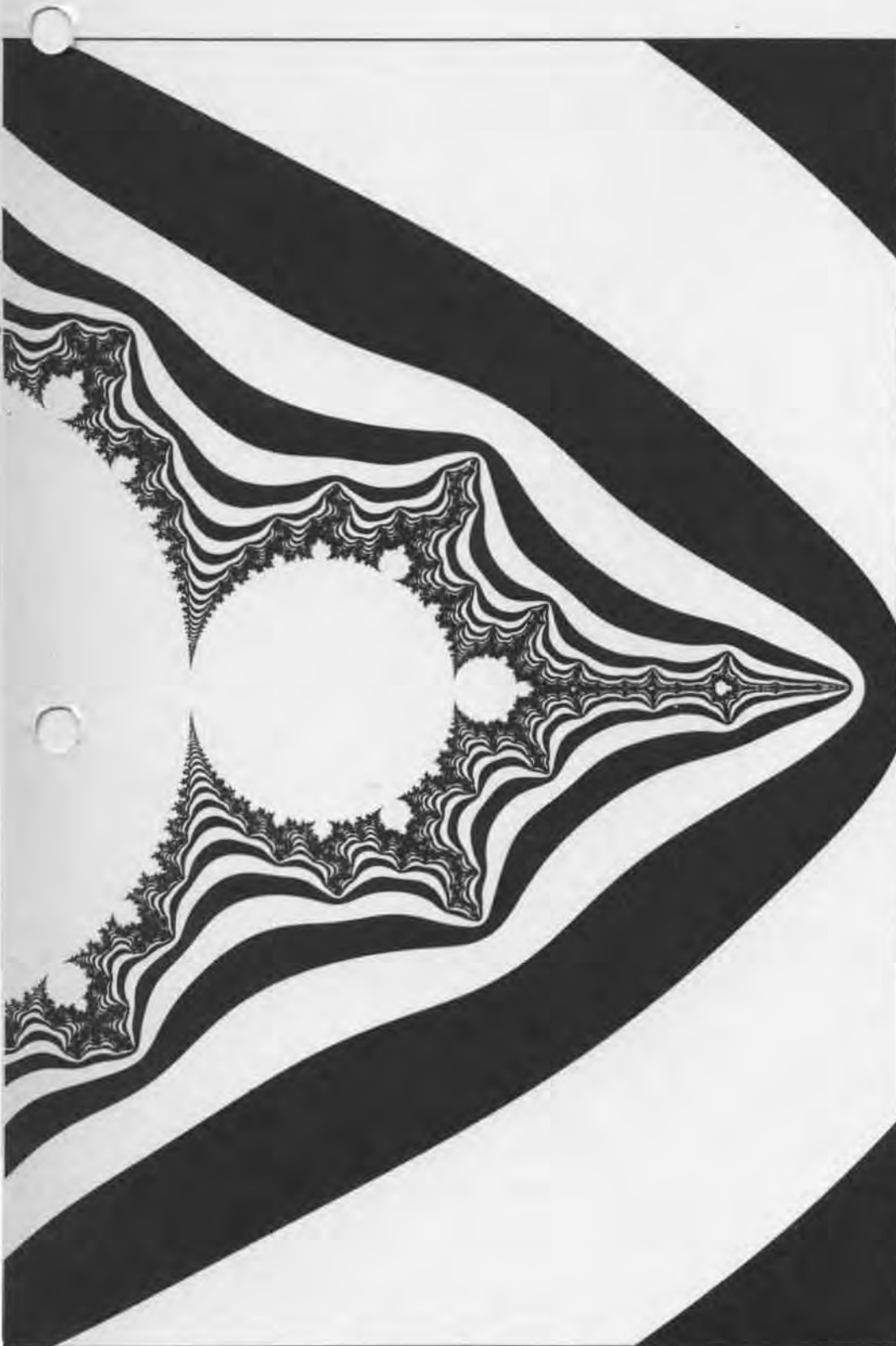

more detailed explorations of these newly discovered objects. But the computation of Julia sets and Mandelbrot sets can also be viewed as numerical experiments in complex dynamics. When combined with mathematical intuition, they uncover universal pat-

terns and stimulate the progress of mathematics. They are also important in the new field of fractal geometry. Indeed the boundary of the Mandelbrot set is a fractal. Mandelbrot conjectures that it may have a fractal dimension of 2, which would mean

that all offshoots would have to be connected to the main set and that the set's surface has barely been scratched. According to John H. Hubbard, Professor of mathematics, Cornell University, who was the first to make detailed computer images of the Mandelbrot, it is "the most complicated object in mathematics".

The iteration of complex functions also models the way many non-linear natural systems evolve. Simple iterative laws can predict very complex, chaotic behaviour. Examples include the growth and decline of the population of a biological species, the motions of the planets, the changes in the weather and even the daily fluctuations of the stock market.

The Mandelbrot set, courtesy of Benoit Mandelbrot/IBM

Further Reading:

The Beauty of Fractals by H-O Peitgen and P. H. Richter, Springer-Verlag 1986

This new release contains approximately 75 color and 65 black and white illustrations, including many of the images on display in the exhibit. The text appeals to both layman and expert, and ranges from philosophical background to suggestions on how to generate your own fractal images. (\$33.95 postpaid, \$30.95 members)

The Fractal Geometry of Nature by Benoit B. Mandelbrot, W. H. Freeman, 1983 (\$38.95 postpaid, \$35.45 members)

Introduction to Chaotic Dynamical Systems by Robert L. Devaney, Benjamin Cummings, 1985 (\$33.95 postpaid, \$30.95 members)

The above books are available from The Computer Museum Store. Also available are a set of 8 color postcards of the Bremen images, including several on display in the exhibit (\$4.00 + 1.00 postage).

Scientific American Computer Recreations column by A. K. Dewdney, August 1985 issue



The End Bit 0000000001

The first computer-generated land use map produced in May 1959 on the TX-0 at MIT. It shows the assessed land value of a 1000 x 1000 foot area of central Boston. Boylston Street and the Boston Common form the right edge of the map. The triangle shaped block is the Sheraton Plaza Hotel. The three shades of grey represent land value, with white the highest. The data was amassed from various records and gridded into 20 x 20 foot cells by hand. After input into the TX-0, maps were displayed on the CRT and photographed with a specially mounted Polaroid camera. *Map produced by Gwen Bell for Harvard's Graduate School of Design master's project; program by Gordon Bell.*

Address Correction Requested

Non-Profit
Organization
U.S. Postage
PAID
Permit No. 110
Fitchburg, MA
01420



SYN	DESCRIPTION	DATE	DRW. BY	CHKD BY	ENGR.
A	RELEASED FOR PRODUCTION				

The Catalog of Personal Computers

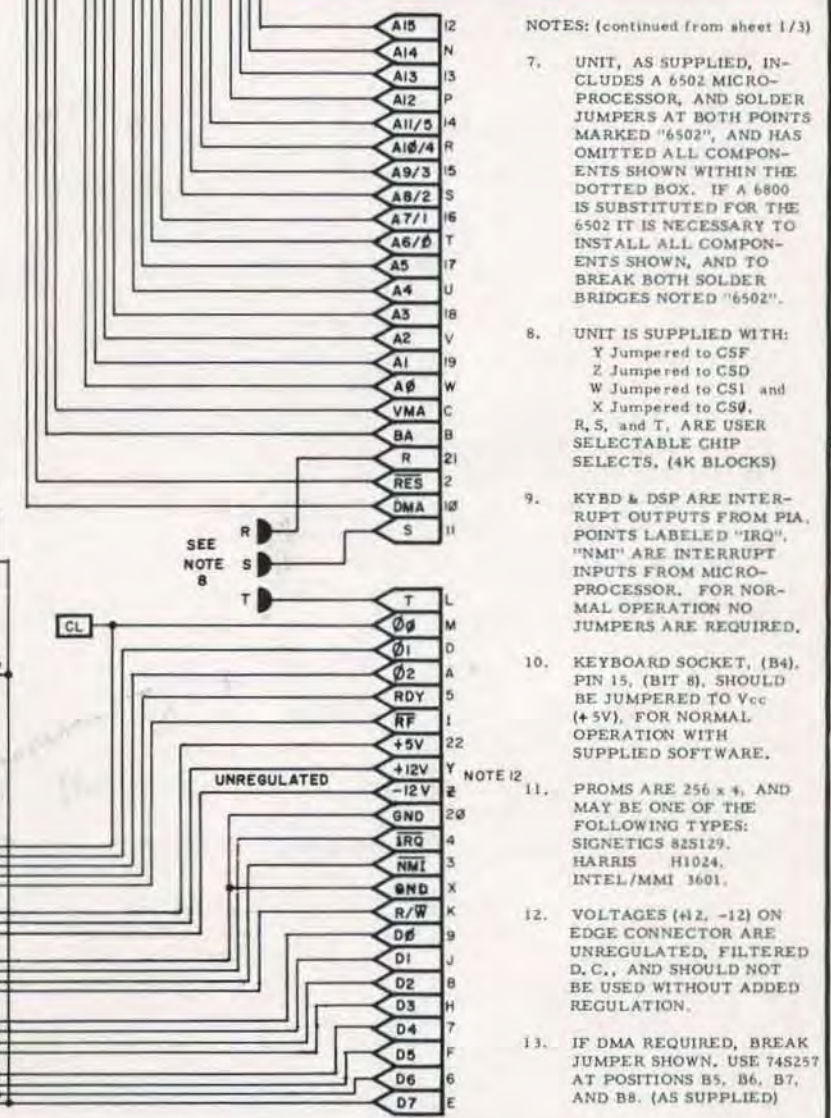
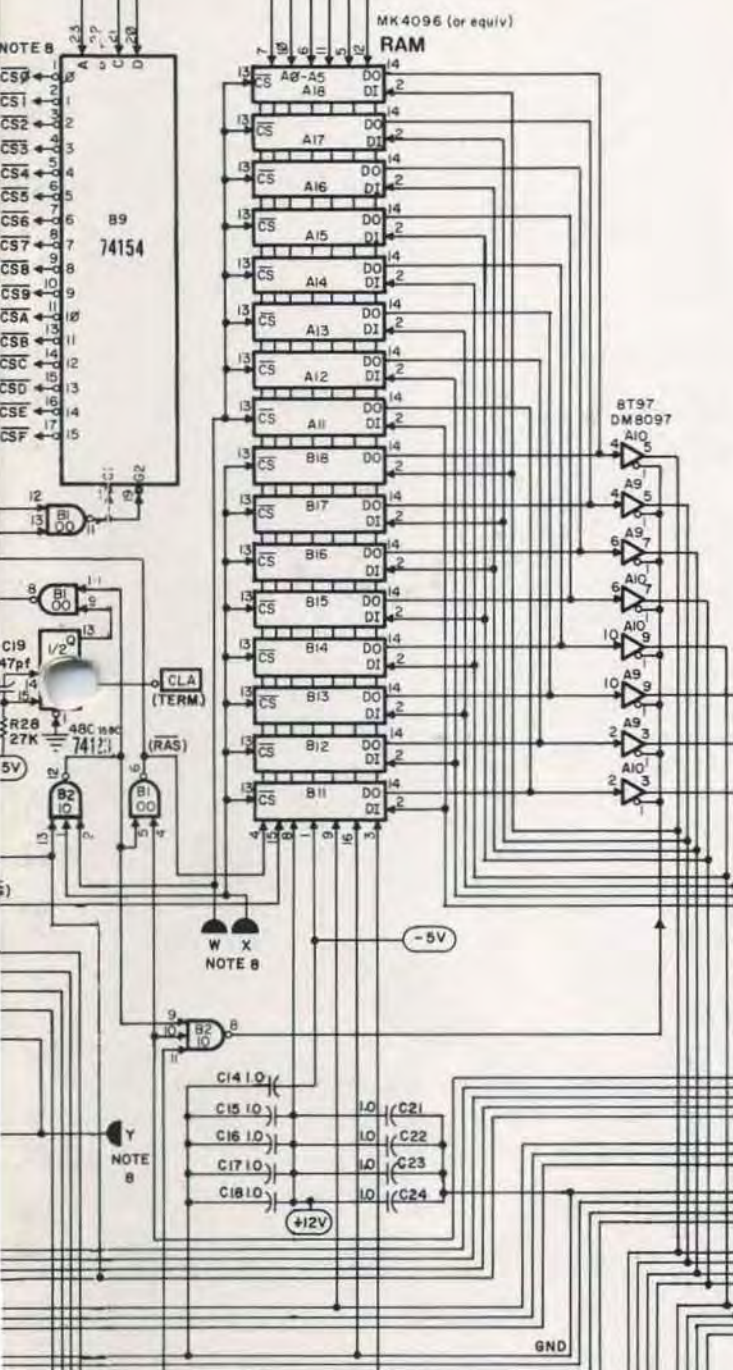

- NOTES: (continued from sheet 1/3)
- UNIT, AS SUPPLIED, INCLUDES A 6502 MICRO-PROCESSOR, AND SOLDER JUMPERS AT BOTH POINTS MARKED "6502", AND HAS OMITTED ALL COMPONENTS SHOWN WITHIN THE DOTTED BOX. IF A 6800 IS SUBSTITUTED FOR THE 6502 IT IS NECESSARY TO INSTALL ALL COMPONENTS SHOWN, AND TO BREAK BOTH SOLDER BRIDGES NOTED "6502".
 - UNIT IS SUPPLIED WITH:
Y Jumpered to CSF
Z Jumpered to CSD
W Jumpered to CS1 and X Jumpered to CS0.
R, S, and T, ARE USER SELECTABLE CHIP SELECTS. (4K BLOCKS)
 - KYBD & DSP ARE INTERRUPT OUTPUTS FROM PIA. POINTS LABELED "IRQ", "NMI" ARE INTERRUPT INPUTS FROM MICRO-PROCESSOR. FOR NORMAL OPERATION NO JUMPERS ARE REQUIRED.
 - KEYBOARD SOCKET, (B4), PIN 15, (BIT 8), SHOULD BE JUMPERED TO Vcc (+5V), FOR NORMAL OPERATION WITH SUPPLIED SOFTWARE.
 - PROMS ARE 256 x 8, AND MAY BE ONE OF THE FOLLOWING TYPES: SIGNETICS 82S129, HARRIS H1024, INTEL/MMI 3601.
 - VOLTAGES (+2, -12) ON EDGE CONNECTOR ARE UNREGULATED, FILTERED D.C., AND SHOULD NOT BE USED WITHOUT ADDED REGULATION.
 - IF DMA REQUIRED, BREAK JUMPER SHOWN, USE 74S257 AT POSITIONS B5, B6, B7, AND B8. (AS SUPPLIED)

reproduce this document, or any part thereof, nor to make use of any information herein contained is granted, except by written agreement with, or license by, the Apple Computer Company.

INTERPRET THIS DRAWING PER USAS1 Y14.5 UNLESS OTHERWISE SPECIFIED DIMENSIONS ARE IN INCHES TOLERANCES ON: FRACTIONS - +1/16 *** ±.1 ANGLES - ±1° ** ±.1 SURFACE FINISH - *** ±.010	DRAWN BY R. WAYNE	DATE 4-2-76	APPLE COMPUTER COMPANY
	CHECKED S WOZNIAK	DESIGN ENGINEER 3-10-76	
MATERIAL - REF - 00100 NEXT ASSY USED ON APPLICATION	APPROVED SCALE	DRAWING NO 00101	SHEET 2 OF 3

Board of Directors

Dr. John William Poduska, Sr.
Chairman
Stellar Computer, Inc.

Dr. Gwen Bell,
Founding President
The Computer Museum

Erich Bloch
National Science Foundation

David Donaldson
Ropes and Gray

John J. Evans
Manufacturers Hanover Trust

Dr. Sydney Fernbach
Computer Consultant

Gardner Hendrie
Arthur Humphreys
ICL

Mitchell Kapor
Lotus Development Corporation

August Klein
MASSCOMP

Dr. Koji Kobayashi
NEC Corporation

Dr. Robert Lucky
AT&T Bell Laboratories

James L. McKenney
Harvard Business School

Dr. Carver Mead
California Institute of Technology

Dr. Robert M. Metcalfe
3Com Corporation

Dr. Arthur P. Molella
The National Museum of
American History,
Smithsonian Institution

Russell Noftsker
Symbolics

Nicholas Pettinella
Intermetrics, Inc.

Jonathan Rotenberg
The Boston Computer Society

Jean E. Sammet
International Business Machines

Edward A. Schwartz
Digital Equipment Corporation

Irwin J. Sitkin
Aetna

Dr. W.J. Spencer
Xerox Corporation

Dr. An Wang
Wang Laboratories, Inc.

Trustees

Charles Bachman, C. Gordon Bell,
Harvey D. Cragon, Robert Everett,
C. Lester Hogan, Theodore G. Johnson,
Andrew Knowles III, John Lacey,
Patrick McGovern, George Michael,
William Millard, Robert Noyce,
Kenneth Olsen, Brian Randell,
Kitty Selfridge, Michael Spock,
Erwin Tomash, Paul Tsongas,
Maurice Wilkes

Executive Committee

David Donaldson, *Chairman*, Dr. Gwen
Bell, Theodore Johnson, August Klein,
Ralph Linsalata, Prof. James McKenney,
Nicholas Pettinella, John William
Poduska, Sr. Jonathan Rotenberg, Paul
Severino, Hal Shear, Ronald Smart,
Oliver Strimpel

The
Computer
Museum
300 Congress Street
Boston
Massachusetts
02210

Corporate Donors

Sustainer
American Telephone & Telegraph*
Bank of America*
The Boston Globe*
ComputerLand*
Control Data Corporation*
Data General Corporation*
Digital Equipment Corporation*
Hewlett-Packard
International Business Machines, Inc.*
NEC Corporation*
Wang Laboratories, Inc.*

Benefactor—\$10,000

AFIPS, Inc.*
American Express Foundation
Apollo Computer, Inc.*
International Data Group*
The MITRE Corporation*
Raytheon Company
Sanders Associates
The Travelers Companies
Xerox Corporation

Patron—\$3,000

Addison-Wesley
Bitstream
Boris Color Labs, Inc.*
Burroughs Corporation
Computer Society of the IEEE
Coopers & Lybrand
Data Translation
DECUS*
Dentsu (New York), Inc.
Draper Laboratories*
Gaston Snow & Ely Bartlett*
General Computer Company
Gourmet Caterers, Inc.
Honeywell Information Systems
Liberty Mutual Insurance Company
Lotus Development Corporation
Major Computer, Inc.
MASSCOMP
McGraw-Hill, Inc.
The MITRE Corporation
NEC Systems Laboratory, Inc.
Nolan, Norton & Company, Inc.*
Phoenix Software Associates Ltd.
Prime Computer Corporation
The Prudential Insurance Company
Regis McKenna, Inc.*
Ropes & Gray
Software Results Corporation*
Stratus Computer, Inc.*
Sun Microsystems
Symbolics, Inc.
3Com Corporation*
/u/s/rl group

Contributor—\$1,000

Access Technology
Adage, Inc.
Analog Devices, Inc.
American Management Systems*
Arthur Andersen, Inc.
Arthur D. Little, Inc.
Autographix
Automatix
Bank of Boston
Bank of New England
Baybanks
Bolt Beranek & Newman
Boston Safe Deposit & Trust Company
BusinessLand
Citicorp (USA), Inc.
Cullinane Foundation
Dane, Falb, Stone & Co.
Deloitte Haskins & Sells
Foley Hoag & Eliot
Ford Motor Company*
General Systems Group, Inc.*
GenRad
Goldman, Sachs Co.
Gould, Inc.
Greylock
GTE Data Services, Inc.
GTE Laboratories, Inc.
Houghton Mifflin Company*
Hyams Trust
Index Technology Corporation
INNOVA
Intel Corporation
International Computer Ltd.*
Investment Orange Nasaa, Inc.
LTX Corporation
Manufacturers Hanover Trust
Meditech*
Mentor Graphics
MICOM-Interlan, Inc.
Micro Control Systems
Microsoft*
New York Air*
Pathway Design, Inc.

PC Magazine
Peat, Marwick, Mitchell & Co.
Pell, Rudman, Inc.
Pconcept, Inc.
Polesse-Clancy, Inc.
Price Waterhouse
Project Software & Development, Inc.
Shawmut Corporation
Standard Oil Corporation
SYMEDCO
Teradyne
Warner & Stackpole
XRE Corporation
* Contributed to the Capital Campaign

Core Members

Harlan E. and Lois Anderson
Charles and Constance Bachman
C. Gordon Bell
Erich and Renée Bloch
Howard E. and Jody Brewer
Henry Burkhardt III
Roger and Mary Cady
Howard Cannon
R. Steve Chehey
Robert C. and Eleanor W. Chinn
Pat Clark
Robert G. Clausen
William Congleton
Alex d'Arbeloff
Arnaud de Vitry
David Donaldson
Douglas Drane
Robert Everett
Kenneth G. Fisher
Jay W. Forrester
William Foster
Gardner Hendrie
Winston R. Hindle, Jr.
Peter Hirschberg
Theodore G. and Ruth T. Johnson
John Allen Jones
Mitchell Kapor
Allan Kent
Jack S. Kilby
August Klein
Andrew C. Knowles III
David J. A. Koogler
Edward and Debbie Kramer
John W. and Edna W. Lacey
Ralph and Linda Linsalata
John Norris Maguire
Richard D. Mallory
Thomas and Marian Marill
Daniel D. McCracken
James L. McKenney
Thomas and Elizabeth McWilliams
Carver Mead
Robert M. Metcalfe
Allen Michels
Robert M. Morrill
David and Pat Nelson
Russell Noftsker
Robert Noyce
Kenneth Olsen
John L. Payne
Edward G. Perkins
Russell Planitzer
John William Poduska
Robert M. Price
Fontaine K. Richardson
Benjamin Robelen
Douglas Ross
Jean E. Sammet
Paul and Katherine Severino
Hal Shear
Alan F. Shugart
Richard L. Sites
Ronald G. Smart
Charles E. Spork
Ivan and Maria Sutherland
Del Thorndike and Steve Teicher
Erwin Tomash
Jean De Valpine
Charles P. Waite
Stephen I. Watson
Harvey W. Wiggins, Jr.
William Wolfson

Contributing Members

Patron—\$500 or more

Anonymous, Ray Duncan, Tom Eggers,
Alan E. Frisbie, Tom and Rosemarie
Hall, Robert Kahn, Martin Kirkpatrick,
Andrew Lavien, Nicholas and Nancy
Pettinella, Paul R. Pierce, Ann Roe-Haler,
Jonathan Rotenberg, Oliver and Kitty
Selfridge, Bob Whelan, Leo R. Yochin

Sponsor—\$250

Isaac Auerbach, G. C. Beldon, Jr.,
Philip D. Brooke, Richard J. Clayton,
Richard Corben, Howard E. Cox, James
B. Deaderick, Delta Management, Philip
H. Dorn, Dan L. Eisner, Bob O. Evans,
Branko Gerovac, John and Arlene
Gilmore, Dr. Roberto Guatelli, Robert
Hoffman, M. Ernest Huber, Lawrence J.
Kilgallen, Marian Kowalski, Raymond
Kurzweil, Michael Levitt, Carl
Machover, Julius Marcus, Joe W.,
Matthews, Tron McConnell, R. W.
Meister, Richard G. Mills, Joseph
Nestor, Joseph M. Newcomer, James N.
O'Boyle, Jr., Anthony Ottinger, James
V. Patton, James A. Pitts, Linda J.
Phillips, J. Eric Pollack, Linda & David
Rodgers, Thomas S. Roy II, William M.
Steul, Charles A. Stott, John V. Terrey,
Michael and Beverly Tomasic, G.
Michael Uhler, Allan L. Wallack,
Andrew Wilson.

Donor—\$100

Kenneth R. Adcock, Lawrence Adrian,
Timothy Anderson, Roland Arndt,
Richard G. Bahr, Mario Barbacci, Ph.D.,
Steve F. Barneby, John C. Bartsow,
James Bell, Alfred M. Bertocchi, Lois J.
Bizak, Dr. John R. Blankenship, Richard
C. Bloom, Bontronics, Daniel S. Bricklin,
Fred and Nancy Brooks, D. F. Brown,
Gordon S. Brown, John and Ann Brown,
Roger M. Buoy, James Burnett, W.
Carlson, Maria L. Carr, Charles and
Virginia Casale, George Chamberlain,
George Champine, James F. Cody,
Michael Cronin, Daniel Crowley,
Curriculum Associates, David N. Cutler,
Nick De Wolf, Peter De Wolf, Harvey
Deitel, Lucien and Catherine Dimino,
Ditargiani Family, Theodora Drapos,
Joseph J. Eachus, Fred Ebeling, Dr. J.
Richard J. Eckhouse and Dr. Ruth
Maulucci, William Elliott, Lucian
Endicott, Geoffrey Feldman and Sharon
Lipp, Larry Forte, Clark Frazier, Edward
A. Feustal, J. Thomas Franklin, Kevin
and Judith Galvin, David Goodman,
William Graustein, Stephen Gross,
Jerri A. Haddad, Michael P. Halter, J.
Scott Hamilton, Frank E. Heart, Daniel
and Nancy Heff, Margaret Herrick,
Thomas L. Hohmann, Nancy S. Horie,
Charles A. Jortberg, Richard M. Koroff,
Bryan S. Kocher, Josh and Mabel Kopp,
Neal Koss, Alan and Judith Kotok,
Stanley Kugell, Robert Laman, Curt
Larock, Tsvi Lavi, Grace Leahy, Craig
Lee, John R. Levine, John V. Levy, Reed
Little, George Logemann, Carl D.
Lowenstein, John Lowry, Lube, Inc.,
Arthur Luehrmann, Andrew H. Mason,
Robert O. Mason, Robert Mayer, Jr.,
Richard McCluskey, F. Warren
McFarlan, Jim McIntosh, William and
Vesta McLean, Todd Medlock, Charles
Minter, Allen Moulton, Dr. J. Craig
Mudge, Carol E. Muratore, Dr. and Mrs.
Isaac R. Nassi, Lee Neal, Cynthia and
Richard Nelson, Tim K. Nguyen,
Bernard J. Nordmann, H. Edward Nyce,
Lawrence and Pauline Oliva, Dr. Robert
K. Otnes, John E. Parker, Kenneth D.
Patterson, James and Beverly Philip,
Juan Pineda, Andrew Plescia, James N.
Porter, David Potter, Robert C.
Probasco, Audrey Reith, C. Mike Riggie,
David C. Roh, Michael Rooney, Daniel
Rose, David Rose, Eugene Rudolph,
Howard Salwen, Michael J. Samek, F.
Grant Saviers, Andrew Scott, Sebell
Software Systems, Aaron and Ruth
Seidman, W. Lee Shevel, John J. Shields
III, Diane J. Skiba, Ph.D., Allen G.
Snelder, Robert and Diane Stewart, J.
Michael Storie, David Tarabar, William
R. Thompson, Warren G. Tisdale, Noah
E. VanDenburgh, Thomas Vaughn,
Christian Walker, Joseph B. Walters, Jr.,
Thomas E. Welmers, John D. Wick,
Hugh Wilkinson III, Kevin Willoughby,
Richard Witek, Paul Wittman, T. J.
Wojcik, Jr., D. L. Wyse, Jeffrey N. Zack.

The Early Model Personal Computer Contest

Oliver Strimpel

Contents

- 1 The Early Model Personal Computer Contest
Oliver Strimpel
- 3 The Making of an Engineer and a Computer
Steven Wozniak
- 9 The Personal Computer Collection

Cover

Schematic of the processor section of the Apple 1 computer. See article on page 3 and photograph of the Apple 1 board on page 6.

Reproduced from Apple 1 Operation Manual, Courtesy of Apple Computer.

Gift of Dysan Corporation

Computer Museum

The Computer Museum is a non-profit 501(c)3 foundation that chronicles the evolution of information processing through exhibitions, archives, publications, research, and programs.

Museum Hours: The Museum hours are 10 AM-6PM, Tuesday-Thursday, Saturday, and Sunday, and 10 AM-9PM Friday. It is Closed Mondays, Christmas, New Years, and Thanksgiving.

Membership: All members receive a membership card, free subscription to The Computer Museum Report, a 10% discount on merchandise from The Computer Museum Store, free admission and invitations to Museum previews. For more information, contact Membership Coordinator at The Computer Museum, 300 Congress Street, Boston, MA 02210. (617) 426-2800.

Staff

Dr. Gwen Bell, Founding President

Dr. Oliver Strimpel, Associate Director and Curator
Lynn Hall, Registrar
Gregory Welch, Research Assistant
Bonnie Turrentine, Education Director
Kurt Levitan, Exhibit Specialist
Gregory Schroeder, Reservations

Mark Hunt, Marketing Director
Laura Goodman, Store Manager
Pat Fiorelli, Public Relations Manager
Linda Holokamp, Communications Assistant
Kathleen Keough, Functions Coordinator

Michael N. Olekaiw II, Development Director
Anne Jeackes, Development Coordinator
Ann Versailles, Membership Coordinator

John Niro, Interim Business Manager
Paul Pearson, Accountant

Germain DRK
Public Relations Advisors

Jackson-Blum-Shapiro
Advertising Consultants

Benson Clemons/BCOM Design

Every year the Fall issue of The Computer Museum Report features the Museum's collections. This issue constitutes a complete catalog of the Museum's collection of personal computer hardware as of July 1986. Collected artifacts not relating to personal computers will be listed next year. It follows a somewhat unusual collecting event—the Early Model Personal Computer Contest.

In the Spring of 1985, William Millard, then chairman of ComputerLand, toured the Museum with Pat McGovern, chairman of CW Communications, the world's largest publisher of computer trade magazines, and Gwen Bell, Museum President. Millard noticed gaps in our collection of personal computers and asked how the Museum could remedy the situation before the early machines disappeared. Bell, half in jest, suggested a contest to find the earliest personal computers. Millard took up the idea enthusiastically and offered ComputerLand's support for the collection. McGovern offered to publicize the event and the contest was born.

From October 1985 to March 1986 advertisements appeared in CW Communications' magazines all over the

world. The heading ran—"Wanted: Old Thinker-toys". Phil Lemmons, editor-in-chief of *Byte* magazine also put out the call in *Byte's* tenth anniversary issue.

Offers flooded in—320 in all from 13 countries. The early US commercial machines, topped by the Altair 8800's (13 offers) were well represented. There were also many offers of one-of-a-kind homebrew machines and single-board computers, mostly still in full working order. Perhaps the most bizarre offer came from Argentina—a manuscript dating from around 1800 containing a card punched with holes. Said to be from Marie Antoinette imprisoned in the Bastille, it contained a coded message to her supporters outside the prison. Overall the response from abroad was disappointing; the collection still needs foreign enrichment.

A total of 137 items were accepted. The remainder were declined to avoid excessive duplication, or because they did not really fall into the categories collected by the Museum. The donors shipped their items to us for the final judging by Stephen Wozniak, designer of the Apple II and co-founder of Apple Computer, David Bunnell, an early MITS employee and current publisher

Stephen Wozniak inspecting the Micral. Owing to a hitch at US Customs, this prize-winner arrived just in the nick of time for the judging.



of *PC World*, and myself. It was on this occasion that Wozniak announced his intention to donate his personal collection of hardware and notebooks to the Museum. He also gave a public lecture to a packed house after the judging. We include his talk in this issue as the story behind the machine that epitomized the spectacular growth of personal computing—the Apple II.

In defining the personal computer, we excluded plastic or cardboard educational and toy kit 'computers' (such as *CARDIAC*, *BRANIAC* and *GENIAC*), as well as programmable calculators. We were impressed by machines in several categories. First, there were the highly original designs that had significant impact on the development of the technology. Don Lancaster's TV Typewriter and Lee Felsenstein's Visual Display Module paved the way to the keyboard and screen interface now universal on personal computers. They were each awarded a prize.

Next there were the early commercial products, bold design and packaging efforts. We awarded the first prize to the 1971 Kenbak-1, submitted by its creator John Blankenbaker. This small machine contained an eight-bit processor built up from medium-scale and small-scale integrated circuits, and qualified as the earliest personal computer known to the judges. Thi Truong's 1973 Micral was awarded a prize as the first commercially available microprocessor-based computer. The Scelbi-8B, the EPA Micro 68 and Cromemco Dazzler were given honorable mention in this category.

Some of these machines bore testimony to the extraordinary zeal of the early hobbyists. We gave a prize to Robert Pond's Altair 8800 and honorable mentions to a Southwest Technical Products 6800 and a TRS-80 Model 1 which came complete with every conceivable add-on board or peripheral and with extensive, well documented software collections. One Altair had even been time-shared!

Lastly there were the homebrew machines, some indicating that builders had gone to enormous lengths to make useful machines at low cost. The computer based on an RGS-008 kit



gained honorable mention for completeness. There were machines that must have taken solid weeks of wire-wrapping and soldering to assemble.

We received many offers of magazines, personal computer club newsletters and advertising literature. David Ahl, founder of *Creative Computing* magazine, sent us his large collection of personal computer periodicals. Volunteers from the Boston Computer Society are piecing together the offers to create complete periodical runs. The collections of literature and software will be listed in a later issue.

The contest was a success—the Museum now has a very fine collection of personal computers, including some little known, but significant machines. This provides a unique historical record and a valuable resource for future exhibits.

The winners were flown to the Museum for "Personal Computer Pioneers Day" and presented with engraved silicon wafer medals. From left to right: John V. Blankenbaker (Kenbak-1), Robert Pond (Altair 8800 hobbyist), Lee Felsenstein (prototype VDM-1) and Thi T. Truong (Micral). Don Lancaster (prototype TVT-1) was unable to attend the prize-giving.

The Making of an Engineer and a Computer

I was lucky as a kid because my Mom and Dad got me to do science fair projects, tell jokes, and have fun. I

knew I'd get an electronics project for Christmas. I'd sneak down the night before and open up the packages (then close them up again). It was sort of like exploring a computer system without getting caught. In sixth grade my hero was Tom Swift who used his resourcefulness with technology to do good. The kids on my block wired house-to-house intercoms, helped by the local electronics store where we hung out. We got someone to give us a ton of telephone wire and we just walked down the block hammering it to the fences and jumping into people's yards and burying it in the ground. When you're kids you don't understand that things are owned by others.

Mom gave me 35 cents a day for lunch. I didn't eat; I saved the money for a walky-talky. But I got nailed. The school had a lottery and I spent all the money on tickets. And I lost.

My father, an engineer, taught me how transistors work and got me interested in computers by giving me IEEE reports to read. This way I learned the basics of Boolean logic and built some adders/subtractors for science fair projects. By eighth grade I talked a company into giving me a few hundred transistors and diodes. I built some gates and figured out why they weren't working. It was a good head start.

By the time I got to high school, I was real fast on the slide rule and that helped me become the top math student. But when you're in math you don't take electronics, because you're in the college curriculum. Electronics was a shop course. Somehow a few people covered both. Neither the students nor the teachers in high school knew what a computer was and vacuum tube technology was still being taught. When I was a junior, a

teacher said "we now have a computer and you can use it." I said, "Great... what an opportunity." It was a little board that could be wired to create a relay. The teachers thought this was a computer!

Then, I had a teacher who recognized that I needed something beyond what the school could provide. He had a couple of friends at Sylvania and arranged for me to go down once a week to program computers. They gave me a FORTRAN manual and I thought it was the neatest thing in the world. Then one day, I saw *The Small Computer Handbook* on someone's desk. It described DEC's PDP-8. I read it from



cover to cover learning about binary arithmetic, how ands and ors work, about registers, instruction sets, sequencing, and everything you needed to know to build a minicomputer. Later, when the growth of minicomputers started exploding, my favorite machine was Data General's

NOVA. I started to design my own versions of it. Sometimes it would take 20 pages to design a floating point add. Then I tried to make the design smaller and smaller. Every time a company, like Fairchild, would come out with a new chip, I'd go back and re-design the NOVA using that chip. I'd make the design better and better using fewer chips. If I could have afforded building any of these machines, I would have stopped designing and learning. The reward was in improving a design.

In 1968, I headed off to the University of Colorado where I signed up for a computer class. This gave me the opportunity to sign up for computer time by using my student number. I didn't understand that computer time was charged for. As a kid I really didn't know about accounting principles—and I was still a kid. I was put on probation for computer abuse. I ran some programs that just printed scrap paper as fast as they could; others that ran every mathematical table that I could find—powers of two, inverse powers of two, and so on. Eventually my factorials would take more than a page and it would run 60 pages worth; that was what the CDC machine could do in under the minute that I was allowed as a student. It would punch out cards which I could submit again to make it start up exactly where it had stopped. I used 60 pages for each of six sets of tabulations three times a day for about a month. There were reams and reams stacked up in my dorm. I never thought that my professor would think that I was trying to get him because I was spending money that was unbudgeted.

That year I built my first video project, a device out of one transistor and some old radio parts that jammed TVs. I didn't try it in my dorm because they knew me. I went to another dorm, sat in the TV room and started to jam the picture. A friend, in on the gag, went up to the TV, hit it, and I unjammed the picture. Each time I'd jam it, my friend would have to hit it harder and harder. Everyone understands that when an inanimate object doesn't work you just hit it. I discovered in that age of peace-loving anti-war college students that you could turn any group

into animals just by jamming the TV set. One time I jammed it and someone said the TV repairman had been in and had said it was the antenna. So he held the antenna up in the air, and the set was perfect, but only for a couple of minutes, then it went bad again. The guy held it up higher. Same scenario. When it went bad, he stood up on a chair, and it worked, for a while. Up on his tiptoes it worked; down on his heels it didn't work. On another occasion they discovered if you touched the set in a weird position—hand on set and leg on the chair—it worked. He said, "It's a grounding effect." And they watched the last half hour of *Mission Impossible* with a hand on the middle of the TV.

The computer class was very large. The professor would lecture to a quarter of the students and the rest would watch on TV monitors in another room. I built the TV jammer into a magic marker pen and took it to class. The class started and I jammed the TV. Three teaching assistants stood up, looked us over and I was scared. Then, before I panicked, someone picked up his books and started to leave early. He was near the worst jammed TV. As he got up the TV started to go in and out, until as he walked out the door it was perfect. I learned that whatever prank you do, make someone else get the credit.

My second year of college was in Cupertino. They had an IBM 360. I took some computer courses that gave me no credit at all, but they were what I wanted to take. I met a computer operator and I found that as an insider he had keys and passwords. We would go in late at night and run programs. By sliding a piece of paper over the official record on the console printer, we prevented our jobs from being recorded. One night the manager of the center came in at about 2 AM and found me alone in the computer room. I was scared because he didn't even know me. I said, "Larry went out for the pizza."

To pay for my third year of college, I went to work for a mini-computer company. It had a great machine with 64 terminals that could run FORTRAN and other programs. But the company was hit by the recession and went under. It was surprising for me to learn that people could invest two million dollars in a company and it couldn't make it.

In my spare time a friend and I built "The Cream Soda Computer", because we drank cream soda while we put it together from spare parts given

Blue Box, 1972

Inspired by the "phone phreak" hero Captain Crunch, Steve Jobs and Stephen Wozniak built their own tone generators to make free calls. Known as blue boxes, they were sold in the dormitories of the University of California at Berkeley where Wozniak was an undergraduate. The particular box shown here was demonstrated to a packed roomful of students performing the legendary experiment of calling around the world to a phone in the next room. The signals had to travel over such a great distance that there was sufficient delay for a person to walk over to the receiving phone to hear his own voice. Following this demonstration, Richard Prelinger bought the box for \$120.

The box used a crystal oscillator and was switched on or off simply by inserting or removing the plug leading to the earpiece. The early boxes were equipped with a safety feature—a reed switch inside the housing operated by a magnet taped onto the outside of the box. Should the phone phreak be apprehended, the magnet could be removed quickly, whereupon the blue box would generate distorted off-frequency tones rendering it inoperable. "You tell them it's just a music box", said Wozniak. The taped-on magnet is visible on the bottom right side of the box.

Gift of Richard Prelinger

to us by another company. The friend that helped me build it, introduced me to another friend, Steve Jobs. We were introduced because we both liked pranks and electronics.

In 1971, after a little stint on unemployment insurance, I went to Berkeley, one of a handful of colleges offering computer science, for my third year of college. I took a course on writing assemblers and wanted to learn computing, read every manual, try every code, and learn every language. Getting grades or going to classes was of secondary importance. One time I signed up for ten courses and only went to five. Steve Jobs, a freer spirit, went off to Reed College in Oregon, where he only attended the courses that he wanted to, not the ones that he was registered for. Reed was also free and let him hang around for two years.

One day at my parents house, I read an article characterized as "fic-

tion" about these weird phone phreaks who drove around the country in vans with racks of equipment in their buses, plugging into communications networks. The author, Captain Crunch, philosophized that exploring the phone system would improve it for Ma Bell. I fell in love with this philosophy. I wanted to explore a system and a computer and I didn't care about free calls. Half way through the article, I called Steve Jobs up and started to read it to him. Suddenly I realized there were too many details in the article—frequencies of 700 hertz and 900 hertz. They gave too much information. It's too real. These are not things that a fiction writer can make up. My source for material at the time was the Stanford Linear Accelerator; I knew I could always get in there on the weekend. With those high end research types, the door was never locked. Steve and I went to the library and





started to research the phone system. We discovered that the frequencies mentioned in the article were correct. Now we knew that we could build a box and make free phone calls all over the world. We even managed to meet the author of the article, Captain Crunch. I was so pure about the philosophy of the phone company as a system, that I paid for my phone calls home. Then, late at night, I'd call every country in the world. I showed it off. I told phone jokes. I sold blue boxes on the campus. I just wondered how far I could get. But I was still pure, I paid for everything I should pay for—I was just using unused wires. It was disappointing when I found out that the phone phreaks were not pure.

After that year at Berkeley I had to take another year off to work and earn enough money to go back to college. I got a job as an engineer at Hewlett Packard designing scientific calcula-

tors, an incredibly good product that bypassed slide rules. My career kept going up. While it's widely reported that I'm a college dropout, that's not true. It just took ten years until I had enough money to finish.

I started to get away from computers. The blue boxes had been fun. Then I heard about "Dial-a-Joke" and I started the first one in the San Francisco area. In those days you could not own your own answering machine, you had to rent it from the phone company. Two thousand calls a day came into my machine to hear a Polish joke. Then the Polish/American Congress Incorporated in Chicago twice threatened me with law suits. I said, "How about Italian jokes?" They said, "Fine with us." Twelve years later the organization gave me their national heritage award.

One night after work, I walked into a bowling alley and I saw the first Pong game. It blew me away. I wanted one and since I knew TV sets and digital logic, I designed my own. Around that time, Steve Jobs got a temporary job at Atari. He introduced me to some of those people, but I wouldn't leave such a good company as HP for Atari. HP really cared about its employees and I just didn't feel like leaving, for any reason. On the side, Steve and I got a job to design the game Breakout for Nolan Bushnell at Atari.

Then, one day, I went to see my old friend Captain Crunch who was in his basement on a teletype. He said, "I'm playing chess with someone at MIT." Then said, "Look I can log into all these computers." He was on the ARPANET. I said, "Wow, I've got to do this." The only way that I could afford it was to build a terminal. I designed a video terminal because the cheapest input output device was your own tv set. Later Captain Crunch was to go to prison for phone phreaking. The second time he got caught the judge said that if he ever did this again he would go to prison. He got the same judge the third time.

I had been out of the computer area for a while and I wasn't aware that the microprocessor had been introduced. A friend of mine, who had gone to MIT, called me up and said there was club starting up for people who had built terminals and things. Since I had just built a terminal and since I like to show off, I said, "Great, I've got to go to this meeting and show off my terminal." He didn't tell me it was a microcomputer club because if he had, I would have said, "I don't know anything." And I wouldn't have

gone. I met a lot of interesting people there who were all talking about the new Altair Computer. Somehow everybody knew that some day they were going to own their own computer. I had decided back in high school in the sixties that I was going to own a personal computer—a 4K NOVA was what I really wanted. At the time, it was the cost of two Pintos and almost the cost of a home. This was a big thing to think: to have a computer instead of a home or a car. Now I discovered that there were people around who knew how to build affordable computers. And, I got back into the field by studying a microprocessor instruction set, the inner workings of the chip. I discovered a microprocessor was just like a minicomputer.

Over the next year, the club grew to five hundred members who met twice a week. We all worked for companies with mainframes—and submitted our decks of cards through the window and the computer priests would run the program. We'd try to crash the system because it wasn't ours. We were a group that had a purpose: the revolution of home computers. Byte Magazine started. In the beginning most home computers were sold as kits and you had to be a hobbyist who knew how to use a soldering iron and not be afraid to put one together. The members of our club were not high level managers; we ran around with holes in our jeans, and were a technical community who wanted their own computers. The club was based on sharing. Lee Felsenstein conducted our meetings. The first segment was called the mapping period. People offered information, material or discussed problems. For example, one of the members would ask, "Is there anyone here from AMI?" If no hands went up, he'd say, "I've got some chips to raffle off for the club." He gave the first Pong chip for your home Pong game to members of the club before Atari got it. Then, in the random access groups, people matched offers and problems.

I still could not afford a computer so I started to think about building one for myself. A new company called MOS Technology introduced a new microprocessor, the 8-bit 6502 costing \$400. It was the finest microprocessor yet and they sold it over-the-counter at a show in San Francisco for \$20—a very unique marketing step. A lot of folks from the club bought one and that night at the Homebrew Computer Club meeting it was a big topic.

A company called Sphere stopped

Apple 1, 1975

In designing the Apple 1, Wozniak squeezed as many functions as he could onto a single PC board. The upper two rows of integrated circuits constitute the video terminal he designed in 1974 to access mainframes remotely; it contains its own memory consisting of 7 1K dynamic shift registers and displays 40 characters per line, 24 lines per page and automatic scrolling. It interfaces to an ASCII encoded keyboard which is plugged into the empty socket at location B4. The video output and low voltage AC power sockets are at the top left corner. The lower two rows are the computer, shown in schematic form on the cover. The 6502 microprocessor is in the white package on the bottom row towards the left; the 16 chips on the right (A,B11-18) are 4K dynamic RAM's; 2 PROM's, containing the 256 byte resident system monitor program, are at the bottom left corner. The memory could be expanded to 65K via the edge connector on the right.

Gift of Dysan Corporation

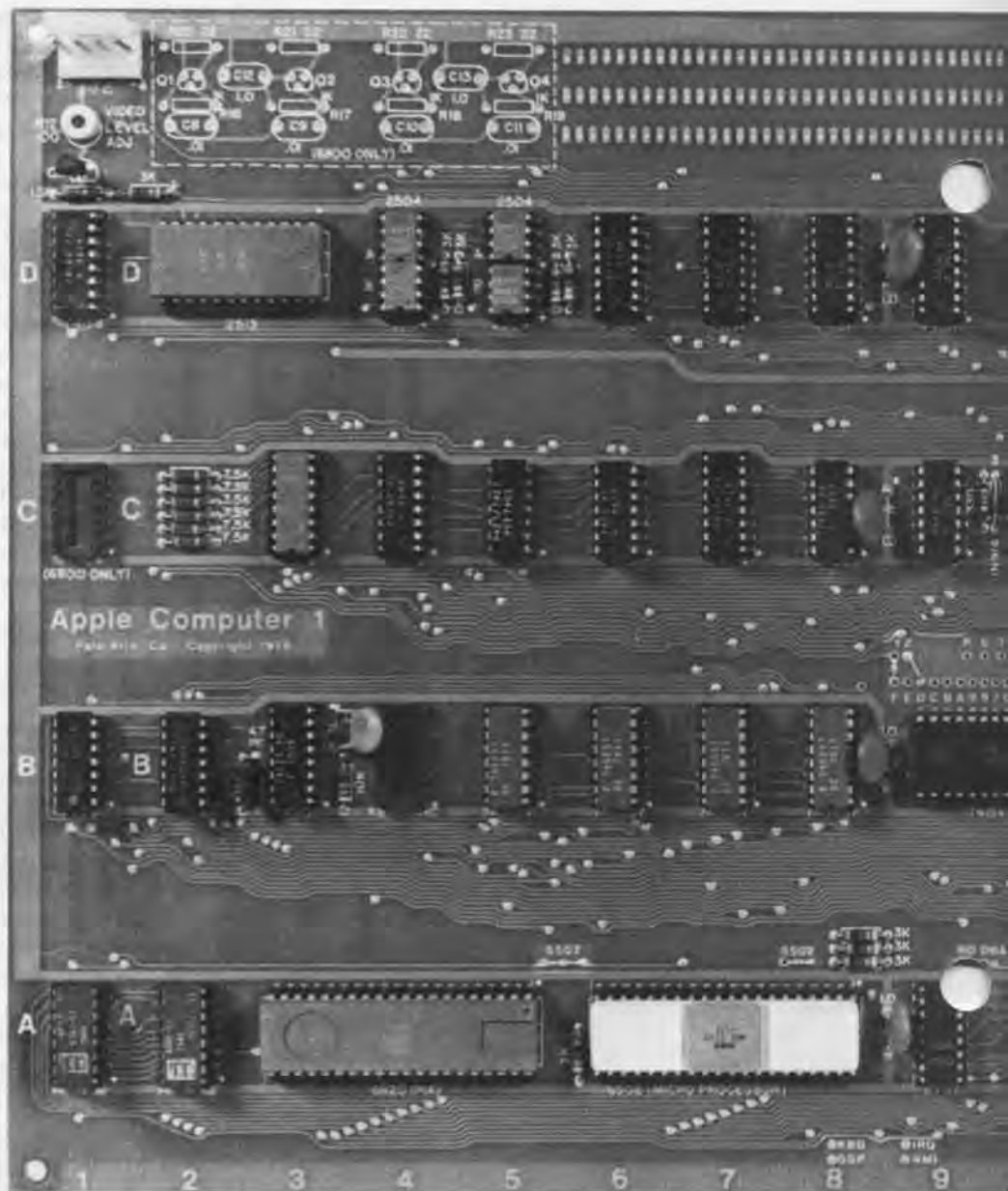

by our club meeting with a 16-bit minicomputer hooked up to a color monitor that spun a color clock around. To see a computer doing color on a video screen was beyond our imaginations. It was shocking. This was at the time that Microsoft BASIC was only available on paper tape for input via Teletype terminals. The first two attempts at color for personal computing came from the club: the Dazzler, built by Cromemco, and the Apple II computer.

Although I had a FORTRAN and ALGOL background, I saw that BASIC was going to be the language for personal computers. Within two months I wrote a BASIC that would run on the 6502. I wrote a simulator in ALGOL to see that it would work. I had to assemble the code by hand, because I didn't have a computer to work on. Once it was done, I put together what became known as the Apple 1. I

worked hard and late to get it done before January when I was getting married. In late November 1975, I demonstrated the Apple 1 computer running BASIC. All it could do was a tab and a print.

I went to Hewlett Packard with the design and the costs and suggested that they manufacture and sell it for \$800. My manager was intrigued with a machine that could run BASIC and have 4K of RAM that would sell for about the same price as HP's top-end calculators. He was especially interested since HP's desk-top machine sold for \$5-8,000. He said no to the project in the end. But this took weeks.

One time when I was showing off the computer at the club, Steve Jobs came along and said, "Why don't we sell it?" I was passing out a lot of schematics and literature because a lot of people wanted to build one. Steve said, "Let's just make the PC

board for \$20 each and sell them at the club for \$40." We figured we'd have to sell 50 to get our money back and we didn't think we could sell that many. Steve said, "We might not sell 50, but at least we'll have a company." Steve's motivation was to be like Nolan Bushnell. I was telling Steve about everything that microprocessors would do one day, which was everything that minis did. I bought a microprocessor for \$20, a keyboard for \$60, a few transformers for about \$10 each, and picked up the integrated circuits from the lab stock at HP. The company has a written rule that any engineer can take chips from lab stock without cost for a project of their own design if their supervisor approves. The company feels that one learns by doing, and that the lowest level of management can decide.

One day Steve called me up at HP and said, "Guess what." "What?" "I

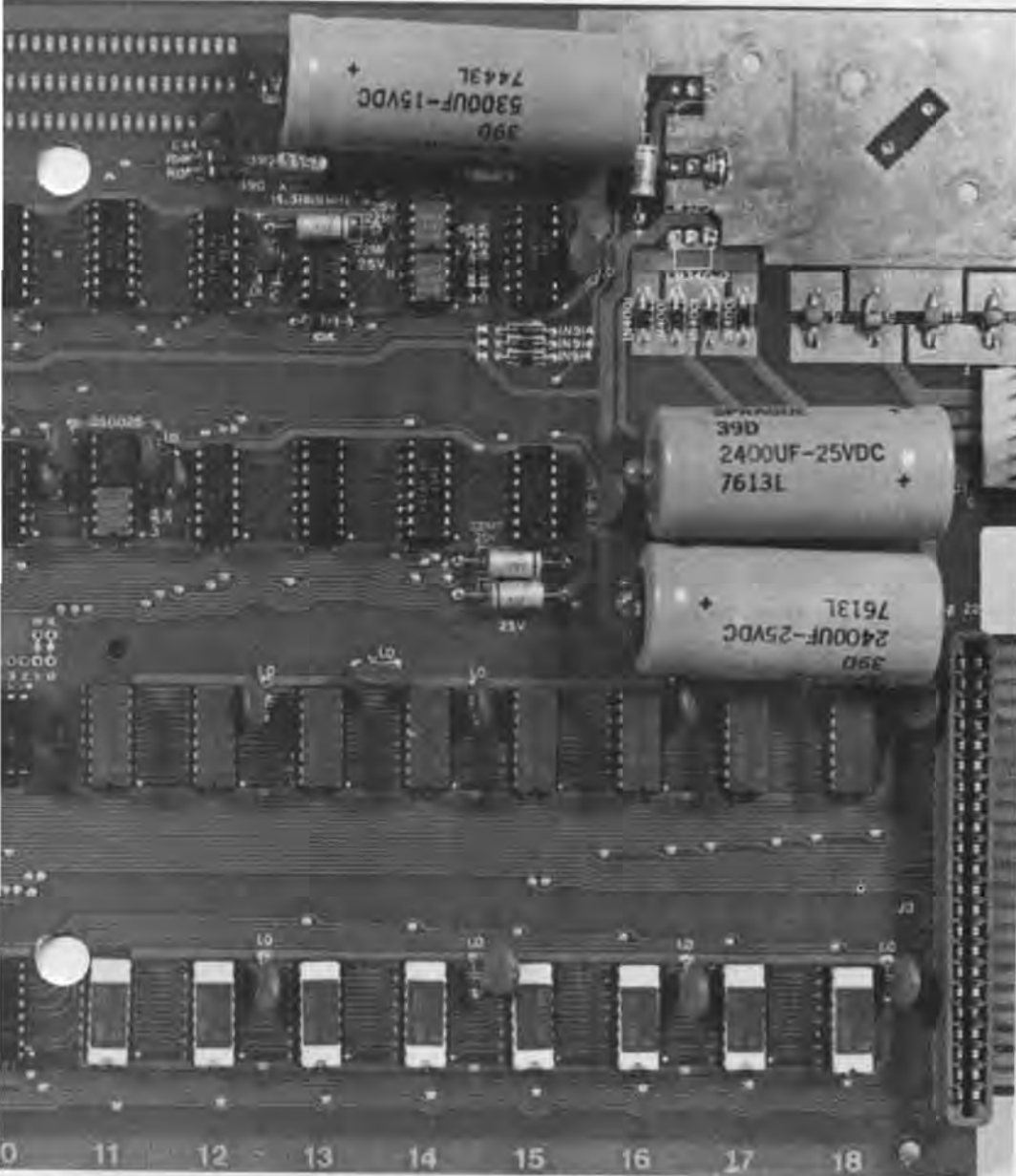

got an order for \$50,000." That was the biggest shock of the Apple experience. Steve had gone down to the Byte Shop where they bought Altairs as kits, wired them in the backroom, and sold them as personal computers. Steve discovered that it would only cost \$13 to insert all the chips on our board. The Byte Shop placed an order for 100 computers at \$500 each and we had to purchase the parts. To come up with the money, I sold my HP-65 calculator for \$500. However I knew we were coming out with the HP-67 the next month and my employee price would be \$37, so I didn't take much risk. I still had my HP job as well. Steve went to the component suppliers and by showing the order asked for 30 days net credit. The chips were stocked in a closet at the company making the board. When the chips came out of the closet the 30 days started. When the pc boards came off the line, they would be stuffed with the

chips and then put on the wave soldering machine. In two days 25 boards were complete and we drove over and took them to Steve's garage. We'd plug in the keyboard and the TV and some transformers and test the boards with the oscilloscopes to see if they would work. On the weekends we would sit down with the ones that didn't work, and usually found the problem in bent pins. Then we would deliver them to the local store and get paid. It was a ten day cycle. It's amazing what you can do when you have one level of management.

The Apple I design had few chips and was optimized for one board. The biggest decision was memory; the first 4K dynamic RAMS were about to come out. One principle that I had was "the fewer chips the better". After a discussion about chip size and number of pins, I decided that I would go for optimizing board size. When the 4K

dynamic RAMS came out I could do in 4 chips what I used to do in 32. In 1975 several styles of 4K dynamic RAMS came out; the first set were from AMI and the second from Intel. The Apple I had the right RAM, a 16 pin Intel chip that led to a 16K RAM.

After I had my legal release for the machine and was selling Apple Is, HP had a project called Capricorn—doing everything that I had just done. I went to the new lab manager and I said I'd do anything to work on the personal computer and he turned me down.

Steve and I went to Atari and asked if they would like it. They said, "No, the home video market is going to be very large." They were so friendly to us, that they let us buy chips for the Apple I right out of their warehouse. We went down to Commodore and talked to Chuck Peddle who was about to do the Pet Computer. Steve thought we might get a few hundred thousand dollars but they only offered us employment. All in all about 200 Apple I's were sold out of the garage.

A few months later, I started to think about color. I made sure that the Apple I worked at the right speed so that color could be added. Things began to coalesce. I realized that I could combine video screen memory and processor memory and save chips. The Apple II design started to emerge. It would be twice as fast, do twice as many things, and have tons of memory. In the first days, I designed the Apple II to work with both 4 and 16K RAMS (because the 16K chips were still very expensive). There was an issue of slots for extra cards. How much do they matter? The only argument over the Apple II design was that Steve Jobs wanted two slots and I wanted eight because I was a little leery about locking into too little. So I sat down with Steve and said, "OK, I don't want the company." And we had eight slots. That was the end of it.

I decided to write the Atari game Breakout on a microprocessor, in BASIC not in hardware. So I wrote some commands in BASIC to put color dots on the screen and to make sounds come over a little speaker. It was shocking to me how much you could do in software and still run so much faster than hardware.

Originally Apple had three partners: Steve and I each had 45% and Ron Wayne, who helped with the manual, had 10%. Ron sold his 10% to us for \$800. The Apple II looked like an outstanding product that could sell 1,000 a month. We thought we had hit the big one. The problem was that we didn't

know how to build a thousand of something that cost \$250 each. Where would we get \$250,000 worth of credit? We had to look for money. People would come by the garage and ask, "What's the market?" I'd say, "A million." They'd say, "What makes you say that?" And I'd have too rational an answer: "There's a million ham radio operators and more people are getting into computers." There's no way that answer could be wrong but they weren't the right words. We got directed to Mike Markkula, who had wanted to build computers in the home for quite a while. He had left Intel with a lot of stock options and he was still young. He started developing a business plan and joined us as a third and equal partner. For a while I didn't want to leave Hewlett Packard. Then a friend said to me, "Steve, you can start this company, manage it and get rich. Or, Steve, you can start this company, stay an engineer all your life and get rich." I realized that I could still sit down and write code and build things, and that the company was just a way to make money. We hired a President who could get things done. Steve had a friend at Atari who could design switching power supplies which required less cooling than the regular type. Our phony reason for needing this was our belief that no computer should have a fan.

We started producing Apple II's. This was the first computer that you could take out of the box, plug in, read only a little bit and start typing, "playing" BASIC. It was the first computer to be in a plastic case; it was the first computer to come with video as standard; it was the first to build BASIC in ROM; it was the first low cost computer to come fully assembled; it was the first to have paddles and sound. Fortunately it had a lot of memory slots. While the world only wanted 4K bytes that year for anything, they thought maybe 8 sometime, but 48K bytes would never be needed. In the beginning, The Commodore, Radio Shack and Apple machines all sold in about equal numbers. Then, 8K programs started to come out and, in 1978, the first spreadsheet and floppy discs came out. Both needed more than 8K of RAM. The Apple was the one of the three that had expandable memory and could support spreadsheet or floppy control software. With Visicalc

computers had a different flavor: now you could walk into a store and buy a computer with a solution. Our dreams of people controlling garage doors and keeping recipes were of much less importance.

A lot of things happened at Apple because one of the top managers had a pet project. One of Mike Markkula's pet ideas was that recipes and keeping track of the check-book were going to be principle uses. So he had Randy Wigginton (who was to write MacWrite in the future) write a check-book program in BASIC. Two things came out of that: a floating point BASIC to make it easier to write money handling programs, and the addition of a floppy disc to make the machine fast. The current practice had been to use cassette tapes that took three minutes to load a program after which you could add the data for two checks, and then download, which took another several minutes. We started to work on both projects. The floppy disc controllers at the time used about 50 chips. I had figured out a design with five chips and thought that I must be leaving important things out. But after a lot of analysis of other designs, I found that mine did even more. So I knew that I was onto a good winner: real fast, real small (based on the new 5 and a half inch disc from Shugart), and real cheap. From that time, Apple took off. We were backlogged for four months of orders and the path had been set.

We premiered the floppy disc at the first National Computer Conference in Dallas that allowed microcomputers to be shown. This completed the initial development of the Apple II. I don't remember much about the show, but the hotel was the first one that I stayed in that had movies you could dial in your room. I had designed one of these systems while I was at Hewlett Packard and I knew that it has to send your room number down to a computer. Travelling with our tools, we opened up the box and saw a bunch of switches. I just toggled in a different code on the switches and didn't get billed for the movies. Randy Wigginton and I looked at the touch-tone phone with different numbers for room service and so on. We took it apart and rewired the keypad to go vertically instead of horizontally.

QUESTIONS

There are some things that are inevitable in history and other things that depend on a unique individual. How do you feel about your role?

Almost everything would have happened about the same time. It turns out that my whole life was directed to one kind of computer design and when the window occurred, I was there. It was great luck for me.

What is it like to have to use an assumed name to go to college and to be a hero?

I used an assumed name and went back to Berkeley in 1981-2 for a full year. And I got away with it, because I wasn't known quite that well then. It was strange to read about myself. I couldn't understand why people would want to come up and shake my hand. Then I met Ted Turner who was my hero for challenging the networks and I asked him for his autograph. I now understand that we all want to have heros.

How do you feel about the Macintosh?

I love my Macintosh. I brought it on the trip. I dropped it in the San Francisco airport but it lived.

What's your relationship with Apple?

Since the computer keeps track of the employee benefits, I make sure that I get the minimal salary. I travel on their behalf, consult with them, and think its a great company.

What is your new company doing?

CL 9 is working on remote control devices for the home. It's not going to be a huge company but it's fun. Right now two engineers are working together in an environment where we can do great things.

The Personal Computer Collection

Complete Hardware Listing as of July 1986.

x-numbered artifacts constitute the permanent collection.

s-numbered artifacts are duplicates, retained for exhibits and loans.

Acorn Computers, Ltd.,
Acorn Atom,
Gift of Acorn Computers, Ltd.
(X667.86)
Gift of Nigel H. Searle (S26)

Acorn Computers, Ltd.,
Acorn Electron, (X666.86)
Gift of Acorn Computers, Ltd.

Acorn Computers, Ltd.,
BBC Model B Microcomputer, with
6502 Second Processor, Z80
Second Processor, Acorn Data
Recorder, Music 500 Synthesiser
and Teletext Adapter, (X665.86)
Gift of Acorn Computers, Ltd.

APF Electronics, Inc.,
PeCos I, (X710.86)
Gift of Carl D. Hess

Apple Computer Company,
Apple I, (X210.83)
Gift of Dysan Corporation

Apple Computer, Inc.,
Apple II Plus, (X539.84)
Gift of Katherine Schwartz

Apple Computer, Inc.,
Apple II, (X683.86)
*Gift of Dr. and Mrs. Fred O. Smith
and family*

Apple Computer, Inc.,
Apple III, (X684.86)
Gift of Kenneth Dockser

Apple Computer, Inc.,
Apple Lisa, (X496.84, S48,
S49)
Gift of Apple Computer, Inc.

Apple Computer, Inc.,
Apple Macintosh,
(X499.84, S50, S51)
Gift of Apple Computer, Inc.

AT&T Information Systems,
AT&T Personal Computer 6300,
(X639.85, S52, S53, S54)
Gift of AT&T

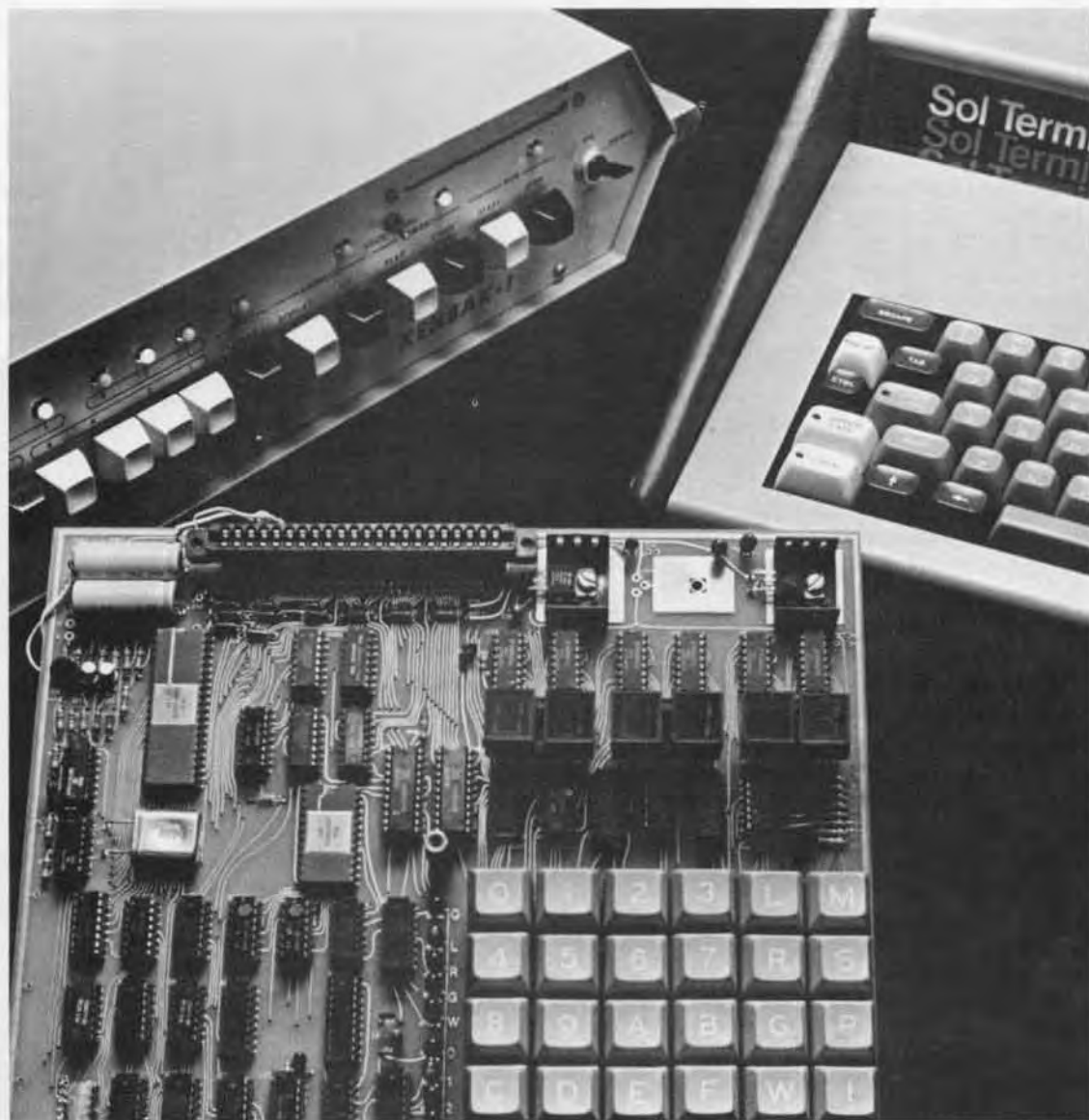

Bull Micral of America (formerly R2E of America), Micral, model XP/2, (X747.86)
Gift of Bull Corporation of America

Commodore Business Machines, Inc., Amiga, (X675.86)
Gift of Commodore Business Machines, Inc.

Commodore Business Machines, Inc., Commodore 64, (X366.84 A-E)
Gift of Commodore Business Machines, Inc.

Commodore Business Machines, Inc., Commodore PET 2001,
Gift of Commodore Business Machines, Inc. (X364.84)
Gift of Microsoft Corporation (S55)

Commodore Business Machines, Inc., VIC 1001 with Japanese keyboard, (X723.86)
Gift of Kenneth C. Barroll

Commodore Business Machines, Inc., Commodore VIC-20,
Gift of Commodore Business Machines, Inc. (X367.84)
Gift of Kenneth C. Barroll (S44)

Compaq Computer Corporation, Compaq DeskPro, (X481.84, S56, S57)
Gift of Compaq Computer Corporation

Compaq Computer Corporation, Compaq Portable, (X484.84, S58, S59)
Gift of Compaq Computer Corporation

Cromemco, Inc., Cromemco Dazzler boards (2), (X687.86)
Gift of Michael K. Lomax

Data General Corporation, Data General Desktop Model 10, (X479.84, S60)
Gift of Data General Corporation

Digital Equipment Corporation, Digital Professional 350, (X435.84)
Gift of Digital Equipment Corporation

Digital Equipment Corporation, Rainbow, (X476.84, S61, S62)
Gift of Digital Equipment Corporation

Digital Group, The Digital Group System 2, (X555.85)
Gift of St. George's School, Newport, RI

Micral, by R2E, 1973

The Micral is the earliest commercial non-kit computer based on a microprocessor. The founder and president of R2E (Realisations Etudes Electroniques), Thi T. Truong, created the Micral as a replacement for minicomputers in applications where high performance was not required. He perceived a big gap between minicomputers, such as the DEC PDP-8, on the one hand, and a wired logic system on the other. As soon as the Intel 8008 microprocessor was introduced, he decided to build a computer to fill this gap.

By May 1973, barely six months after the Intel 8008 became available, Truong together with engineers Francois Gernelle and Ben Chetrite, had the Micral designed and built. It had some remarkable similarities to later personal computers such as a bus system and slots for expansion. The basic original model had 256 bytes of RAM, and could be expanded to 2K with ROMS and PROMS. It was capable of directly addressing 16K, and boards to expand the memory beyond 2K soon became available. The Micral had a real-time clock, eight levels of interrupt priority and automatic enabling and disabling. The CPU, memory, input/output interfaces and fast peripheral controllers all plugged into the Pluribus - a 60-bit single data bus. There were 52 instructions, oriented towards process-control and data transmission applications. Instruction times ranged from 7.5 to



Thi T. Truong, speaking at the Museum after receiving his prize.

27.5 microseconds. The Micral had an assembler and an operating system which supported a teletype and cassette recorder connected to the Pluribus. The machine evolved rapidly, with later models offering more RAM, floppy discs, hard discs and a range of standard software.

The Micral's low cost of \$1950 and bus architecture attracted great interest. By 1974, only six months after the Micral's debut, 500 had been sold; 2000 were sold over the next two years. However, following an unsuccessful attempt to penetrate the US market, Truong could no longer finance the growth of his business. In 1979 he sold Micral to the major French computer maker Bull who currently produce IBM PC-compatible Bull-Micrals.

Micral advertising for the National Computer Conference Exhibition, Chicago May 1974.

you don't need a hammer

A FLY IS TINY. A HAMMER IS HEAVY.
 For everything there is a way to do what you have to do. You wouldn't take a hammer to crush a fly, just as you wouldn't take a microcomputer to compute a usual process. MICRAL™ is a microcomputer which is as complete as a minicomputer. Judge by yourself. Semiconductor RAM, ROM, PROM, or EPROM memory, byte memory, PLURIBUS bus to which the processor, I/O interface, the keyboard, slow speed peripheral, buffered channels (up to 2), are connected. 8 word interrupt levels, up to 20 high speed ports, rate for each buffered channel.

TO CRUSH A FLY, A FLY SWATTER IS THE RIGHT TOOL.
 To crush a fly, a fly swatter is surely more efficient than a hammer. As complete as you find in many cases you don't need speed. MICRAL™ is surely more efficient. A microcomputer as fast as real time applications, process control, instrumentation, scientific instrumentation, teaching, etc. MICRAL™ is the link between wired circuitry and microcomputers.

1974 photo by photo

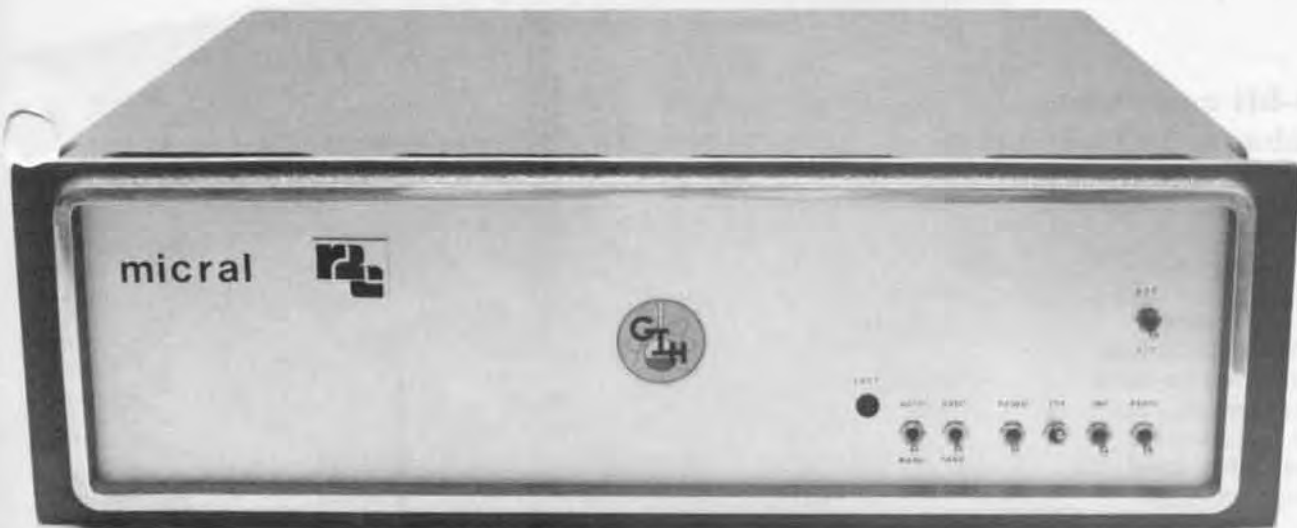

The first Micrals were sold to industry for process control and to the French government to help collect demographic information in France's African colonies. It was therefore supplied with a strong protective metal cabinet.

Gift of Thi T. Truong

The Micral's CPU board. The use of microprocessor earned the Micral the name 'microcomputer', used for the first time in print in the June 21 1973 issue of Electronics magazine.

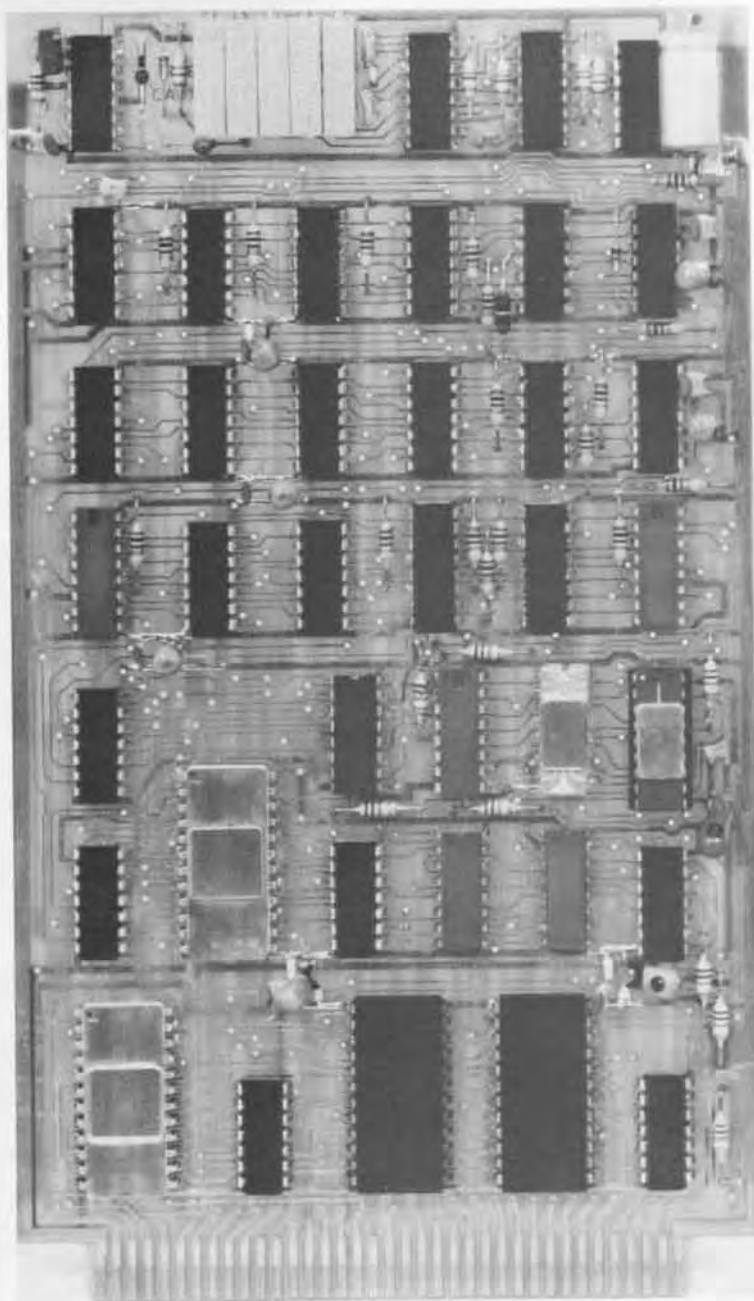

to crush a fly

YOU WOULDN'T PAY FOR A HAMMER WHEN A FLY SWATTER CAN DO THE JOB

Some microprocessors spend some microseconds with a fly, but those microseconds are very fast. So fast that our thrifty customers, they are less than 500 MICRAL[™], in less than 500 microseconds.

You can get a complete ready to use MICRAL[™] for less than 2,000⁰⁰. We naturally have special OEM prices.

MICRAL[™] IS FRENCH
 We, MICRAL[™] manufacturers, are RZE. Our activities are first to manufacture MICRAL[™], second to conceive and realize whole real time systems, on request. To get more information about MICRAL[™], and why not about us, just write to:
 RZE, Zone d'Activites de COURTABŒUF,
 Av. de Scandinavie, 91000 ORSAY - FRANCE



Homebrew 16-bit computer, by Loren Jacobson, 1974-5

This one-of-a-kind machine contains a 16-bit processor based on small-scale and medium-scale TTL integrated circuits. All input and output was via the front panel switches and lights. Jacobson had more time than money, so he used every possible means to keep costs down. For example, very few connectors or sockets were used; all wiring was point-to-point, even between boards.

Gift of Loren Jacobson

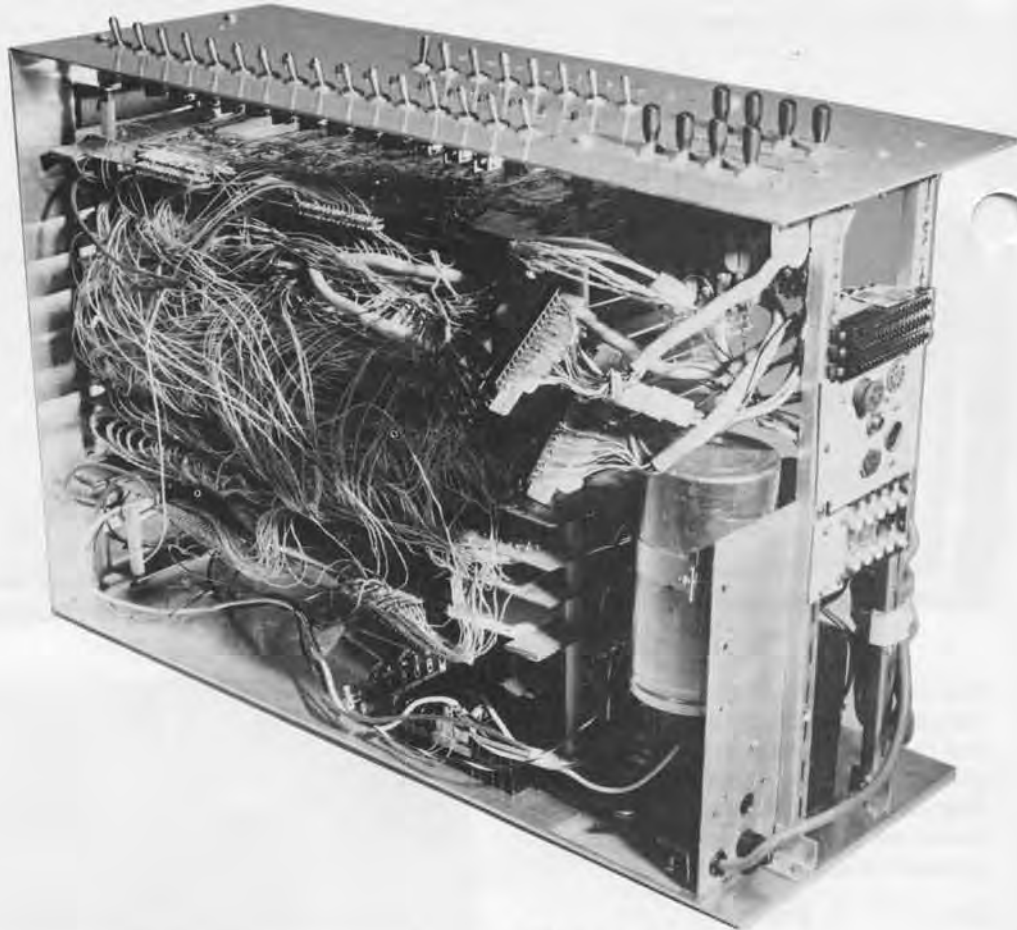

Micro-68, by Electronic Product Associates Inc., 1975

The Micro-68 was a microcomputer trainer based on the Motorola 6800 microprocessor. Priced at \$430, it came with integral numeric keypad input and LED output in a slim hardwood cabinet that could fit inside a briefcase. It had an on-board maximum of 1K words of ROM and 768 words of RAM and could be expanded to 64K via edge connectors. The system was controlled by the John Bug monitor program, contained in a 512-word PROM. This allowed users to load, inspect and edit programs, insert break points for debugging purposes, and execute.

Victor Wintriss, president of EPA Associates, developed the Micro-68 as a low-cost tool for training engineers in the use of microprocessors. It could also be used to prototype applications for the Motorola 6800. 1500 Micro-68's were sold between 1975 and 1978 when EPA went out of business, due in part, to competition from the identical Heath ET3400, introduced in 1976.

Gift of G. Victor Wintriss



Eckert, Scott B.,
Homebrew system based on the
MOS Technology 6502 CPU,
(X699.86)

Gift of Scott B. Eckert

Electronic Product Associates, Inc.,
Micro-68,

Gift of G. Victor Wintriss (X694.86)

Gift of Sanford Shapiro, MD (S31)

Felsenstein, Lee,
VDM-1 Video Display Module
prototype, (X711.86)

Gift of Lee Felsenstein

Franklin Computer Corporation,
Franklin Ace 100, (X340.84)
*Gift of Franklin Computer
Corporation*

Godbout, Thinkertoys, SD Sales,
et. al.,

Various boards for personal
computer kits, (S36)

Gift of Robert Pond

Heath Company,
Heathkit H-8, (X696.86)
Gift of Terry Brandon

Heath Company,
Heathkit H-11, (X695.86)
Gift of Errol Brick

Hewlett-Packard Company,
HP 150 Personal Computer,
(X432.84, S63, S64)
Gift of Hewlett-Packard Company

Home assembled as per Aug. and
Sept. 1976 Popular Electronics
magazine design,
Cosmac ELF, (X692.86)
Gift of Klaus Ernst

Home assembled as per
July 1974 Radio Electronics
magazine design,
Mark-8, (X704.86)

Gift of Myron A. Cahoun

IBM,
IBM 5100,
*Gift of Silenus Wines, Inc.
(X629.85)*

Gift of United Fruit Company (S17)

Gift of Neil Karl (S18)

Gift of Arthur D. Little, Inc. (S22)

IBM,
IBM PC XT, (X430.84, S65)
Loan from IBM

IMSAI Manufacturing Corporation,
IMSAI 8080 Microcomputer System,
Loan from Mike Miller (X589.85)
Gift of Robert W. Beatrice (S32)
Gift of R. Donald Carter (S33)

Intersil, Inc.,
Intercept Jr., (X700.86)
Gift of Stephen S. Mangione

Jacobson, Loren,
Homebrew 16-bit Computer,
(X698.86)
Gift of Loren Jacobson

Jade Computer Products,
Z80 based S-100 Computer System,
(X616.85)

Gift of Joel Goldstick

Kaypro Corporation,
Kaypro 10, (X487.84)
Gift of Kaypro Corporation



Visual Display Module Prototype, by Lee Felsenstein, 1975

Gift of Lee Felsenstein

This unit is the first implementation of a memory-mapped alphanumeric video display for personal computers. The key design innovation was making the RAM directly accessible from the computer's data and address busses, rather than in a character sequential fashion through an I/O port. As Lee Felsenstein put it, he made it possible to view the video display as a "window on memory rather than a glass teletype [such as in the TV Typewriter]". This made it possible for the first time to use personal computers for highly interactive uses such as real-time games.



Lee Felsenstein and the VDM-1.

The unit in the collection is adapted for stand-alone operation. The chassis was salvaged from a Singer-Friden 4321 key-to-tape converter bought at a junkyard. The keyboard was bought at a hobby shop. The unit was used for several months as a terminal in the development of software for The Community Memory Project.

The VDM-1 prototype was demonstrated at the World Altair Convention in Albuquerque in March 1976. Variants of the VDM board were immediately incorporated into many personal computers; the design had a great influence on the development of personal computer video displays. Felsenstein himself used the design in the Sol terminal computer and the Osborne-1.

Kenbak-1, by Kenbak Corp., 1971

The Kenbak-1 was awarded first prize in the Museum's Early Model Personal Computer Contest as the earliest personal computer. It was presented to the Museum by its designer and builder, John V. Blankenbaker.

Blankenbaker became interested in computing while at college. In 1951, during his junior year, he got a job at the National Bureau of Standards where he came into contact with the SEAC (Standards Eastern Automatic Computer) project. The following year Hughes Aircraft charged him with the considerable task of building, from scratch, an arithmetic unit based on binary-coded decimal numbers. At that time, flip-flops cost \$500 each. He struggled to design the machine with the absolute minimum number of flip-flops and even came up with a design that would use only one. Though such a machine would take a long time to get through even one clock cycle, it could emulate any other computer. Blankenbaker was so taken by this single flip-flop design that in 1955 he tried to patent it. Though he was unsuccessful, the idea of a \$500 computer had been firmly planted in his mind.

In 1970 Blankenbaker actually set out to build a small computer. His fixation upon a selling price of \$500 meant that he had to keep the cost of parts down to about \$150. He decided that speed was not important and that the only input/output within the price constraint were lights and switches. However he did cut a slot in the front panel in the hope that one day punched card input could be added.

He could only afford the tooling costs for the printed circuit board. Everything else, including the cabinet, lights, switches and logic circuits had to be made from standard parts. He decided that the machine would be byte-oriented, and that 256 bytes would be a good choice of memory size. This allowed a single byte to store a complete address. In any case, manual

DIGITAL COMPUTER



KENBAK-1

FUN EDUCATIONAL

Modern electronic technology created the Kenbak-1 with a price that even private individuals and small schools can afford. The easy-to-understand manuals assume the reader is approaching a computer for the first time. Step-by-step, you can learn to use the computer with its three programming registers, five addressing modes, and 256 bytes of memory. Very quickly you, or your family or students, can write programs of fun and interest.

PRICE \$750.00

KENBAK CORP.
P. O. Box 49324
Los Angeles, CA 90049

Kenbak's most successful advertisement, Scientific American, September 1971

loading would take too long with any more memory than that. Two 1K-bit MOS shift registers were used.

Since microprocessors had not been introduced yet, Blankenbaker built his processor from standard medium-scale and small-scale integrated circuits. It operated on 8-bit words, one bit at a time. The 1 MHz clock coupled with a serial memory organization gave the Kenbak an effective speed of 1000 instructions per second. Altogether the machine used 130 integrated circuits, all mounted on a single board.

In Spring 1971, a working prototype was shown to a convention of mathematics teachers. Blankenbaker even managed to demonstrate a three-dimensional tic-tac-toe program that just squeezed into the 256 bytes. Complete documentation, programming manual and exercises suitable for school laboratories were published.

The Kenbak Corporation was formed, and the computer was

marketed through advertisements and direct mail. From the start, the machine was billed more as an educational tool rather than as a full-blown machine for executing applications programs. The marketing was accordingly focused on schools as a low cost way of introducing hands-on computing to students.

Although small computers eventually found their way into the classroom in large numbers, the Kenbak never caught on. The alternatives at the time, timeshared minicomputers and programmable calculators, were beyond the reach of school budgets. Teachers were not yet attuned to the idea that an electronic computer might be affordable, and those that wanted one often took a long time to secure the funds. Only 40 machines were sold to schools and a dozen to individuals over two years. In 1973, the Kenbak Corporation closed its doors. Blankenbaker moved on to use his creative engineering talents to build the first production LISP workstation for the newly formed Symbolics Inc.



John V. Blankenbaker

Kenbak Corporation,
Kenbak-1, (X703.86)
Gift of John V. Blankenkaker

Lancaster, Donald,
ASCII Keyboard and Encoder
prototype, (X691.86)
Gift of Don Lancaster

Lancaster, Donald,
Cheap Video prototype board,
(X688.86)
Gift of Don Lancaster

Lancaster, Donald,
TVT-1 TV Typewriter prototype,
(X689.86)
Gift of Don Lancaster

Lancaster, Donald,
TVT-3 TV Typewriter prototype,
(X690.86)
Gift of Don Lancaster

Martin Research,
Mike 2, (X706.86)
Gift of Robert F. Casey

Microcomputer Associates, Inc.,
JOLT microcomputer, (X701.86)
Gift of Brian Yee

MITS, Inc.,
Altair 680b, (X679.86)
Gift of James Post

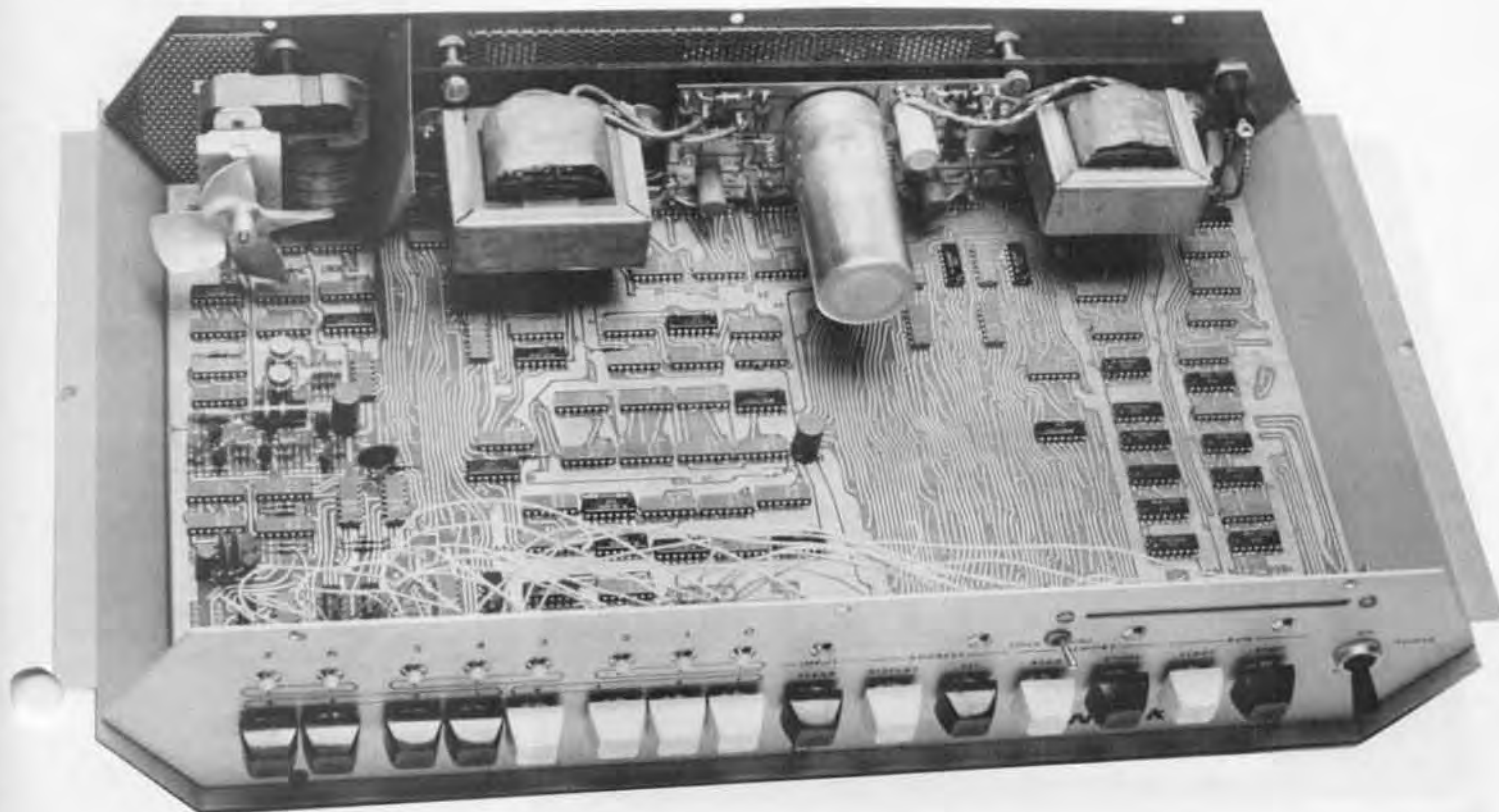

Gift of John V. Blankenkaker

Programming sheet, showing the
Kenbak's instruction set.

LOC	DATA	SYMBOLIC ADDRESS	CONTENTS	COMMENTS
A	0	000		
B	1	001		
X	3	003		
ADD	0	003		
SUB	1	000		
LOAD	3	377		
STORE	3			
OR A	2			
HOOP	3			
AND A	3			
NEG A	3			
IMMED	3			
MEMORY	4			
INDIRECT	3			
INDEXED	4			
IND:KEY	7			
A	0			
B	1			
X	3			
UNC	3			
JPD	4			
JPI	3			
JMD	4			
JMI	7			
#0	3			
#1	4			
#2	3			
#3	4			
#4	3			
#5	4			
#6	3			
#7	4			
SET 0	0 0 3			
SET 1	1 0 3			
SKIP 0	3 0 3			
SKIP 1	3 0 3			
B BIT POSITION				
BT SET	0-1			
BT NOT	1-1			
LFT SET	3-1			
LFT NOT	3-1			
1 PLC	1			
2 PLC	3			
3 PLC	3			
4 PLC	0			
5 PLC	4			
WSCP	3 0 0			
HALT	0 0 0			
CP B0				
CA B1				
A	2 0 1			
B	2 0 3			
X	3 0 3			

MITS, Inc.,
Altair 8800,
Anonymous Gift (X58.82)/*Gift of Robert L. Froemke (X680.86)*
Gift of Robert L. Leffert (S28)
Gift of Robert Pond (S29)
Gift of Wallace B. Riley (S30)

MITS, Inc.,
Altair 8800A with two disk drives, adapted for time-sharing, (X681.86)
Loan from The State of Colorado

MITS, Inc.,
Altair 8800b, (X682.86)
Gift of Jerry Soden

MOS Technology, Inc.,
KIM-1 Microcomputer,
Gift of Commodore Business Machines, Inc. (X365.84)
Gift of Robert F. Casey (S34)

Motorola, Inc.,
Micro Chroma 68, (X707.86)
Gift of Robert Pond

NEC Corporation,
NEC APC III, (X494.84, S19, S20)
Gift of NEC Systems Laboratory

NEC Corporation,
NEC PC-8000, (X446.84)
Gift of Microsoft Corporation

NEC Corporation,
NEC TK-80 (X447.84)
Gift of Microsoft Corporation

Netronics, R&D Ltd.,
Cosmac ELF II, (X693.86)
Gift of S. Scott Kostka

North Star Computers, Inc., North Star Horizon, *Gift of James B. Straus (X708.86)*
Gift of William Romaine (S35)

Ohio Scientific, Inc.,
Ohio Scientific, model 600, (X709.86)
Gift of Bill Leehan

Osborne Computer Corporation,
Osborne I,
Gift of Osborne Computer Corporation (X362.84, S66)
Gift of Ben Rosen (S3)
Anonymous Gift (S9)

Osborne Computer Corporation,
Osborne Executive, (X615.85)
Gift of Joel Goldstick Polymorphic Systems, Polymorphic System 8813, (X614.85)/*Gift of Robert and Margaret Wesley*

Powertran Computers,
Psi 80, (X724.86)
Gift of Livnat Yehiel

Processor Technology, Inc.,
Sol Terminal Computer,
Gift of Richard S. Russell (X715.86)/*Gift of Ray Duncan (S39)*
Gift of Michael Cuchna (S40)



TV Typewriter Prototype, by Don Lancaster, 1973

The TV Typewriter made it possible for the first time to display personally generated alphanumeric information on an ordinary unmodified television set. The design was published in the September 1973 issue of *Radio Electronics* magazine as a home assembly project using only \$120 worth of components. Don Lancaster's design attracted considerable attention as its

extremely low cost proved that home video terminals and video displays for personal computers were practical. High resolution bit mapped displays followed within a few years, enormously enhancing the utility of personal computers. Lee Felsenstein (featured on page 13) called the TV Typewriter "the opening shot of the computer revolution".

It consisted of a keyboard together with circuit boards to provide the memory, cursor, timing and television transmission signals. The

on-board memory consisted of 512-bit serial registers. The memory boards had character generators which displayed each character as an array of 5 by 7 dots. The original design had two memory boards and could generate and store 512 characters arranged as 16 lines of 32 characters. The device could also use a cassette recorder to provide additional storage; a 90 minute cassette could hold about 100 pages.

Gift of Don Lancaster

Altair 8800 by MITS 1975

The Altair is widely thought of as the first personal computer. Indeed, the Altair's creator, Ed Roberts, founder and president of MITS (Micro Instrumentation and Telemetry Systems), coined the term. Distinguishing PC's from hobby machines, demonstration machines, industrial machines and development systems, his view was that PC's had to be used for applications typically run on a minicomputer or larger computer. The PC also had to be affordable, easily interfaced with other devices and feature a conventional console with a keyboard, CRT or something similar. It should have an operating system and mass storage; paper tape was acceptable. A PC should have a reasonably large memory. MITS used 64K because that was what the 8080 could directly address. Lastly, he stipulated that a good number of people had actually used the machine as a computer that was personal!

In thinking about what sort of device to build, Roberts considered the DEC PDP-8 as a prototype. However, the

machine that had the greatest impact on him was the Hewlett Packard 9100, introduced in 1968. It had a CRT, keyboard, magnetic storage for programs and data, and a printer. It could even drive a plotter. But it was not a personal computer by Roberts' definition—it was expensive (\$6000), did not have a real programming language and only had a small memory.

In 1971, MITS introduced the 816, a kind of programmable calculator. Several thousand were sold, mainly for accounting applications and as controllers. In the same period, a company called Prolog built industrial processors based on the Intel 4004, 4040 and 8008. Intel built the Intellect series of machines between 1971 and 1973. The TV Typewriter was also noticed by MITS, as were several logic demonstration devices and an 8008-based machine, the Mark-8, introduced in Radio Electronics in 1974.

In 1972 MITS made a terminal system that could be interfaced to time-shared computers. "In 1973 and 1974 we started design work at MITS with 4004, 4040 and 8008 processors and didn't feel that they were



Ed Roberts.

powerful enough to do the sort of things you normally expect a minicomputer to do", Roberts said. "When we found out about the Intel 8080 in late 1973, we started design on the Altair, which was finished in the summer of 1974."

Ed Roberts and Bill Yates designed the Altair with an open 100-line bus structure. Though originally known as the Altair bus, it was adopted for so many other machines that it later came to be called the S-100 bus (S for Standard). The first machines were shipped with only two of the 18

Gift of Robert Pond



available slots filled with the CPU board and the 256 byte memory board. Programs had to be entered in machine code via the switches on the front panel. During the next few months, MITS as well as many third parties, came out with expansion boards to provide more memory (up to a maximum of 64K) and interfaces for input-output devices and storage media. One of the first boards was a 4K memory board, big enough to hold a 4K BASIC interpreter specially written for the Altair by Bill Gates and Paul Allen.

The original Altair sold without the case for \$297, \$395 with the case—an order of magnitude less than the cost of the PDP-8. Though initially offered as a kit, the first units were sold as assembly units since the kit manuals were not completed.

The demand for the machine exceeded even MITS's wildest expectations. More machines were sold in the first day than the company expected to sell during the entire lifetime of the product. Roberts likes to point out how MITS increased the installed base of general computers by 1% each month for a period between 1975 and 1976. There was a huge pent-up demand for a computer with the kind of power offered by the Altair. Most of the machines were purchased by electronics hobbyists who simply wanted to have a machine of their own. They tinkered with and modified their computers. However the machine was not really powerful enough or equipped with enough software to enable it do useful work conveniently. It was used to control various processes—some industrial, some recreational. One of the first customers used his Altair to control his model railway.

The company was sold to Perlec in 1977 for 6 million dollars. Faced with stiff emerging competition from companies such as Processor Technology, IMSAI, Commodore and Apple, Perlec was unable to retain market share, and the Altair went out of production in 1978.

MITS and the Altair played a central role in the development of the US personal computer market. They pioneered a whole marketing style—computer shows, computer retailing, computer company magazines, user groups and numerous add-on hardware and software options.

Quest, Inc.,
Super ELF, (X717.86)
Gift of Willits High School/ROP

RCA,
Cosmac VIP, (X686.86)
Gift of Robert F. Casey

RZE,
Micral, (X705.86)
Gift of Thi T. Truong

RGS Electronics,
RGS-008, Intel 8008 based
microcomputer built from kit,
(X712.86)
Gift of Brian Yee

Rockwell International,
AIM 65,
Gift of David Martz (X678.86)
Gift of Neil Doughty (S27)

Saga Systems,
Saga, model PPS-800S, (X713.86)
Gift of Computer Maintenance
Corporation

Scelbi Computer Consulting, Inc.,
SCELBI-8B, (X714.86)
Gift of Michael Rossman

Scelbi Computer Consulting, Inc.,
SCELBI-8H, (X574.85)
Gift of Carlton B. Hensley

Sinclair Research Ltd.,
Sinclair ZX80,
Gift of Sinclair Research Ltd.
(X513.84)
Gift of Lea Vanderboom (S37)

Sinclair Research Ltd.,
Sinclair ZX81,
Gift of Sinclair Research Ltd.
(X514.84)
Gift of Arnold J. Savitt (S38)

Solid State Music, California
Computer Systems, Heathkit, et.
al., Various boards for personal
computer kits, (X658.86)
Gift of Alan Frisbie

Southwest Technical Products
Company, SwTPC 6800,
Gift of Steven B. Leeland
(X718.86)
Gift of Fred Laskowski
(S41)
Gift of Dr. Gordon Wolle
(S42)

Southwest Technical Products
Company, TVT-2 TV Typewriter,
(X719.86)
Gift of Robert Pond

Sphere Corporation,
Sphere System 330,
Gift of Dr. Roger J. Spott
(X295.83)
Gift of John Rible (S14)

Sphere Corporation,
Sphere System 320, (X297.83)
Gift of Dr. Roger J. Spott
SSM Microcomputer Products
(formerly: Solid State Music),
SSM CB1 8080 CPU Board,
(X716.86)
Gift of Dana Smith

HOW TO "READ" FM TUNER SPECIFICATIONS

Popular Electronics

WORLD'S LARGEST HOME ELECTRONICS MAGAZINE - JANUARY 1975 - 100¢

PROJECT BREAKTHROUGH!

World's First Minicomputer Kit to Rival Commercial Models...

"ALTAIR 8800" SAVE OVER \$1000



ALSO IN THIS ISSUE!

- An Under-\$90 Scientific Calculator Project
- CCD's—TV Camera Tube Successor?
- Thyristor-Controlled Photoflashers

TEST REPORTS:

- Technics 200 Speaker System
- Pioneer RT-1011 Open-Reel Recorder
- Tram Diamond-40
- Edmund Scientific
- Hewlett-Packard!

The January 1975 issue of Popular Electronics ran a cover story on the Altair which propelled the machine to instant success.



6800 Computer System, by Southwest Technical Products Corp., 1975

The SWTPC 6800 was one of the first computers to be based on the Motorola 6800 microprocessor. The 6800 was thought by some engineers to be more powerful and versatile

than its competitor, the Intel 8080. The computer was sold as a kit, costing \$395 for the basic system which included 2K bytes of RAM and a serial teletype interface. It could be expanded to 16K. It had a mini-operating system in ROM enabling it to boot up automatically without throwing switches on a front panel.

Southwest also offered a video terminal, the \$275 CT-1024, based on Don Lancaster's TV Typewriter, shown on the left in the picture. Above the computer on the right, are the \$79.50 AC-30 cassette interface and the \$250 PR-40 matrix printer kit. In front of the keyboard is a home-made switch box, a useful input device, especially for games. With its complete set of peripherals, the SWTPC 6800 was one of the first low-cost systems on which software could be developed and run in a reasonably convenient fashion.

Gift of Steven B. Leeland

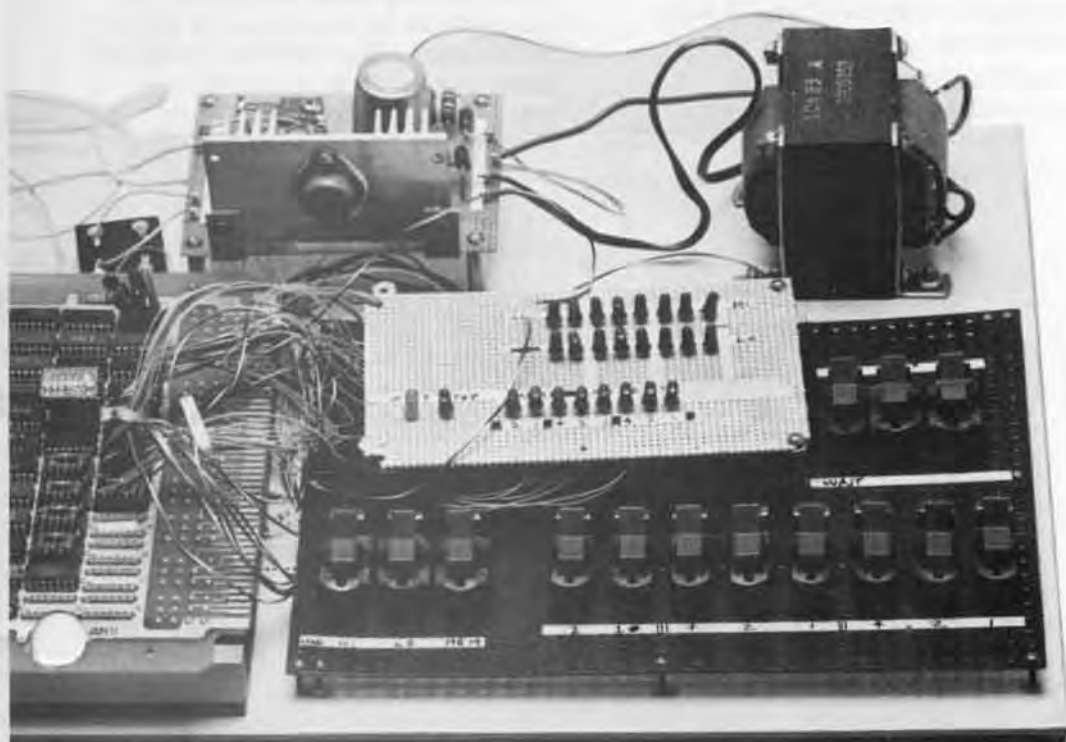

008A Microcomputer Kit, by RGS Electronics, 1974

The 008A was sold for \$375 as a kit based on the Intel 8008. The system had 1K of static RAM, expandable to 16K, and an RC (not crystal) clock. It featured an input/output bus which could handle up to 256 peripheral devices instead of the arrangement of input/output ports more usual with the 8008. The programs were entered into memory using toggle switches. The version received was built on a 60-socket wire-wrap board. The printed circuit board version of the RGS-008 was described in September 1975 in the first issue of *Byte* magazine.

Gift of Brian Yee

Sutherland, James,
ECHO IV Home Computer,
(X509.84)

Gift of James Sutherland

Tandy Corporation,
TRS-80, Model I,
Gift of Melvin O. Duke (X722.86)
Gift of Nigel H. Searle (S43)
Gift of Samuel M. Getber (S67)

Terak Corporation,
Terak Model 8510, (X351.84, S68,
S69)
Gift of Douglas Ross

Terak Corporation,
Terak Model 8512, (X354.84)
Gift of Douglas Ross

Texas Instruments, Inc.,
TI-99/4 prototype (Dimension 4),
(X720.86)
Gift of Robert Childress

Timex-Sinclair, Inc.,
Timex-Sinclair TS-1000,
Gift of Dennis Knollenberg
(X721.86)
Gift of Ruth Leyden (S47)

Van Cleve, Robert,
Homebrew system based on the
Motorola 6808 TV Bug CPU,
(X697.86)
Gift of Robert Van Cleve

Wang Laboratories,
Wang PIC (Professional Image
Computer), (X566.85)
Gift of Wang Laboratories

Wave Mate, Inc.,
Jupiter Computer system,
(X702.86)
Gift of Dennis Painter

Xerox Corporation,
Notetaker 1, (X748.86)
Gift of Xerox Corporation

Gift of Melvin O. Duke



TRS-80, Model I by Radio Shack, 1977

The TRS-80 was Radio Shack's first entry into the computer market. Their wide network of retail outlets greatly increased the accessibility of microcomputers. The TRS-80 was based on a Z80 microprocessor and came with a video display, 4K of memory, BASIC and cassette storage, at a price of \$599.95. It was aimed at the novice—the manuals assumed no prior computer knowledge. The original machine was slow as Radio Shack had kept the price down to an absolute minimum. New software and extended memory were released to improve performance, and in 1979 the more powerful Model II was introduced.

The TRS-80 was extremely successful; the company had projected annual sales of 3000 units,

but over 10,000 were sold within a month of the TRS-80's introduction.

To the left of the TRS-80 is an Exatron Stringy Floppy, a miniature tape-drive which holds a small, continuous, removable tape. Called a wafer, the tapes could be up to 75 feet long and stored 4K bytes on five feet of tape in 6 seconds. It was significantly faster and more reliable than the standard cassette tape drive originally supplied with the TRS-80.

To the right of the TRS-80 is the Comprint Model 912 thermal printer. This could print 225 12 by 9 dot matrix characters per second. It used special silvery-looking aluminum-coated paper. Characters were printed by styli which vaporized the metal surface at the points of contact to expose a black under-layer. The Comprint operated more quietly than impact printers. It was one of the first matrix printers to print letters with true decenders.

Illustrations from the friendly manual "Getting Started with TRS-80 BASIC". Courtesy of Radio Shack



Available From The Computer Museum.

New Color Slide Series!

The Personal Computer Slide Set includes the classic machines from this catalog. The 20 slides, arranged in groups of four, may be purchased as a unit for \$20.00 (\$18 for members). Each group of four slides is \$4.50 (members \$4.05).

Volume II.

The Personal Computer Slide Set

Set 13: The First Personal Computers

- 13.1 Kenbak-1 (1971)
- 13.2 Micral (1973)
- 13.3 Scelbi (1974)
- 13.4 Altair (1975)

Set 14: The Hobbyist Milestones

- 14.1 Apple I Board
- 14.2 Visual Display Module, Lee Felsenstein's VDM-1
- 14.3 Don Lancaster's TV Typewriter
- 14.4 Cromemco Dazzler boards

Set 15: Homebrew and Single Board Computers

- 15.1 Homebrew 16-bit computer by Loren Jacobson
- 15.2 RGS Electronics 008A Microcomputer Kit
- 15.3 Kim 1
- 15.4 Super Elf

Set 16: Early Commercial Machines

- 16.1 EPA Micro 68
- 16.2 IMSAI 8080
- 16.3 SWTPC 6800 (Southwest Technical Products)
- 16.4 Sol Terminal Computer

Set 17: Classic Commercial Machines

- 17.1 Apple II
- 17.2 TRS 80 Model I
- 17.3 Commodore Pet
- 17.4 Sinclair ZX80

Volume 1, 48 slides in 12 sets of four, covers early calculating devices, early computers, super computers, logic and memory technologies, and classic integrated circuits. This set of 48 is available for \$45.00 (members \$40.50).

New Computer Museum T-Shirts!

These four-color quality shirts communicate the spirit of The Computer Museum—antique computers fancifully displayed alongside modern, hands-on computers. These make great Stocking Stuffers.

50% Cotton-50% Polyester. Adult (small, medium, large, x-large) or Children (small, medium, large) sizes; Be sure to specify adult or child, and size. Children sizes, \$6.50 each (5.85 members); Adult sizes, \$8.00 each (7.20 members). Postage Separate.



The Computer Museum Boston

NAME	DAY PHONE
ADDRESS	
CITY	STATE ZIP

Mail your order to: The Computer Museum Store 300 Congress Street Boston, MA 02210

Method of Payment	Card Number
Minimum charge order: \$15.00	
<input type="checkbox"/> Check or money order enclosed (no COD's)	
<input type="checkbox"/> Visa <input type="checkbox"/> Am Ex <input type="checkbox"/> Mastercard	
Interbank No. <input type="checkbox"/> <input type="checkbox"/> <input type="checkbox"/> <input type="checkbox"/> (Mastercard only)	Signature
	Exp. date:

QUAN.	DESCRIPTION	UNIT COST	TOTAL

Please add \$2.50 to cover postage & handling charges for the first item ordered; add 50¢ for each additional item.

Please check here if Museum member.

Thank you. Your purchases help to support the Museum.

SUBTOTAL	
MASS. 5% TAX	
SHIPPING	
TOTAL ENCLOSED	

ORDER FORM

D
C
B
A

8 7 6 5

8 7 6 5

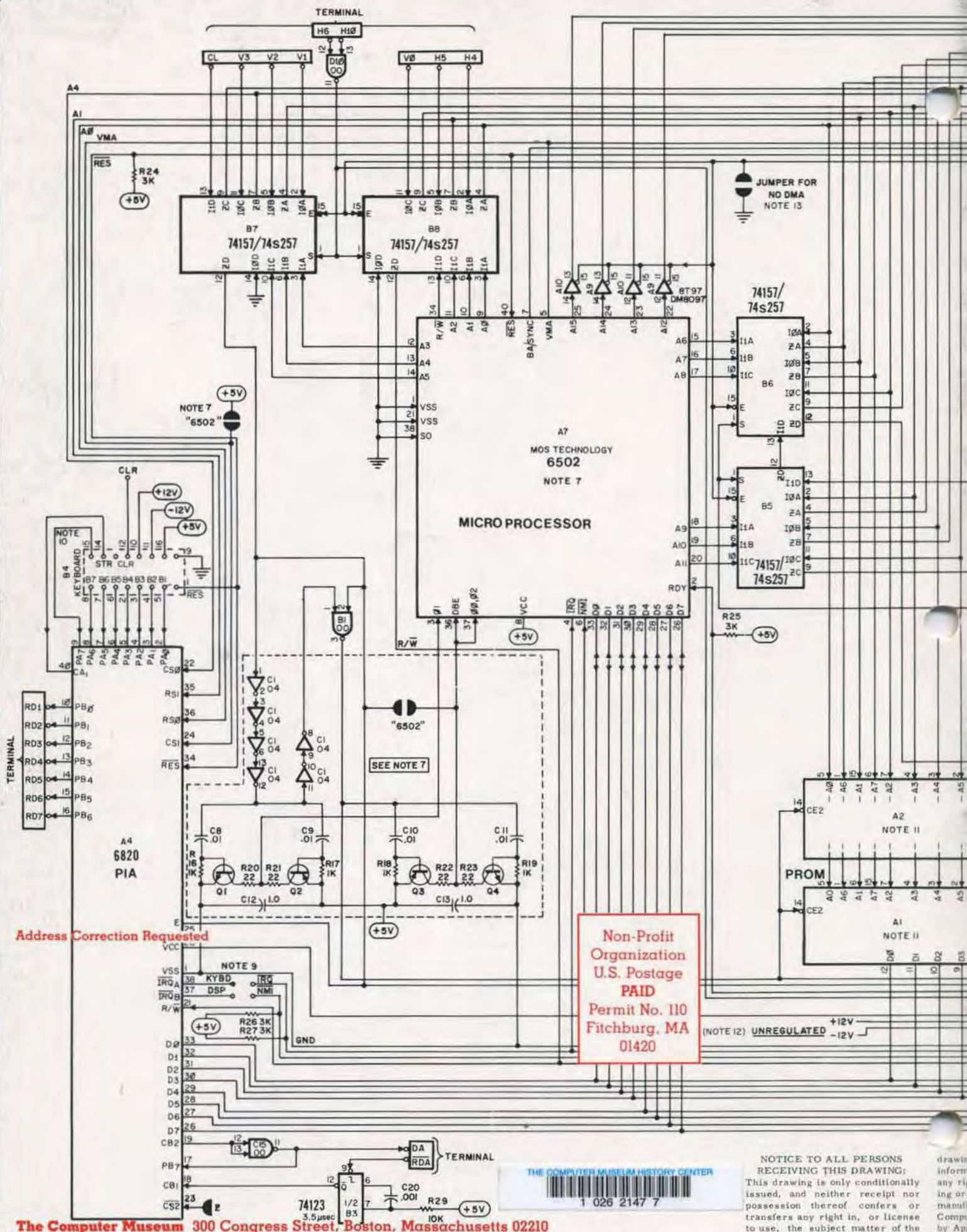

Address Correction Requested

Non-Profit
Organization
U.S. Postage
PAID
Permit No. 110
Fitchburg, MA
01420



The Computer Museum 300 Congress Street, Boston, Massachusetts 02210

NOTICE TO ALL PERSONS RECEIVING THIS DRAWING: This drawing is only conditionally issued, and neither receipt nor possession thereof confers or transfers any right in, or license to use, the subject matter of the drawing information any right in, or manufacture of any Computer by App

THE COMPUTER MUSEUM REPORT

VOLUME 18

WINTER 1987

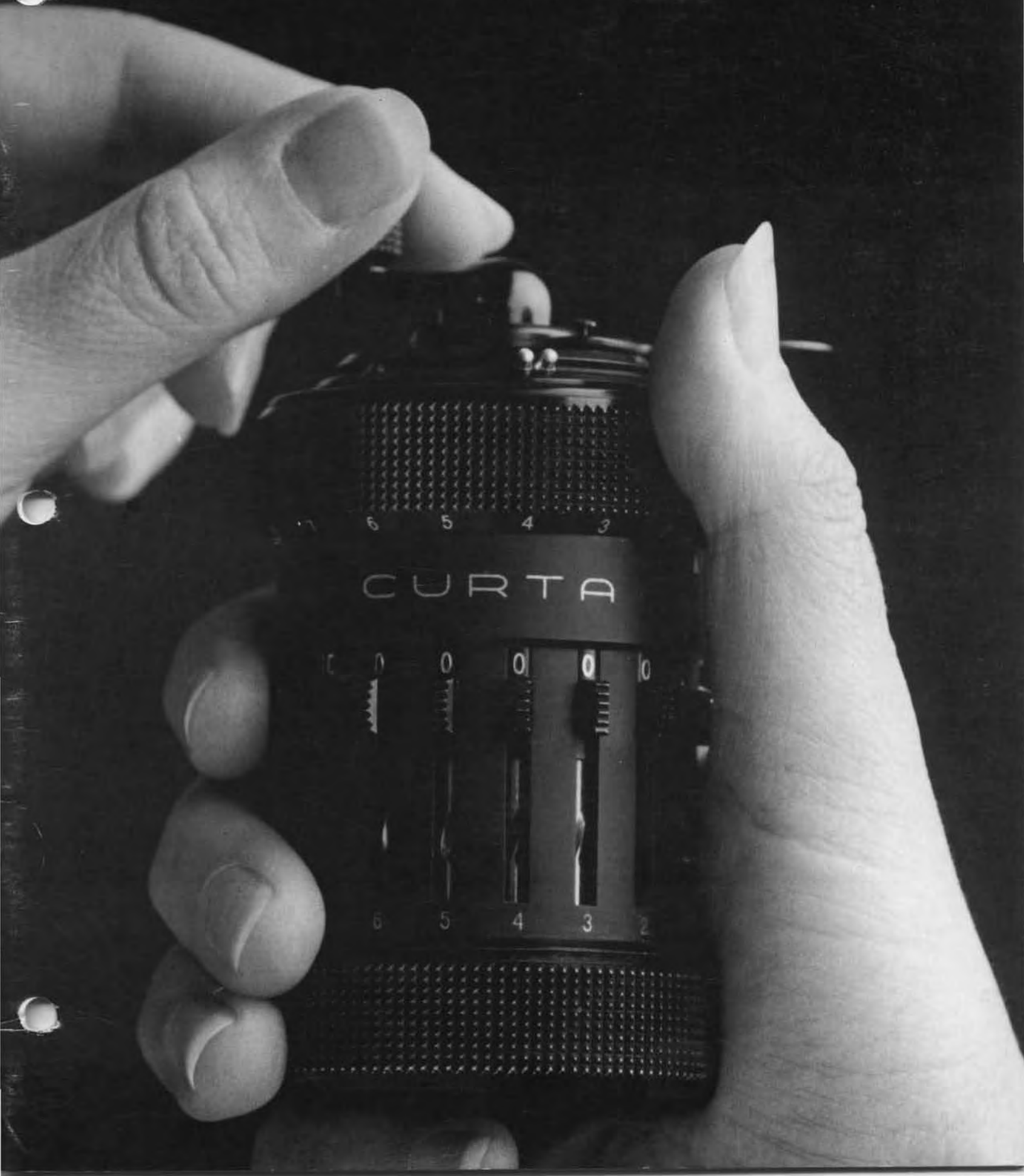

Board of Directors

Dr. John William Poduska, Sr.
Chairman
Stellar Computer, Inc.

Dr. Gwen Bell
President,
The Computer Museum

Erich Bloch
National Science
Foundation

David Donaldson
Ropes and Gray

John J. Evans
Manufacturers Hanover
Trust

**Dr. Sydney Fembach
Gardner Hendrie**
The Signal Group

Arthur Humphreys
ICL

Mitchell Kapur
August Klein
MASSCOMP

Dr. Koji Kobayashi
NEC Corporation

Dr. Robert Lucky
AT&T Bell Laboratories

James L. McKenney
Harvard Business School

Dr. Carver Mead
California Institute of
Technology

Dr. Robert M. Metcalfe
3Com Corporation

Dr. Arthur P. Moella
The National Museum of
American History,
Smithsonian Institution

Russell Noftsker
Symbolics

Nicholas Pettinella
Infermetrics, Inc.

Jonathan Rotenberg
The Boston Computer
Society

Jean E. Sammet
International Business
Machines

Edward A. Schwartz
Digital Equipment
Corporation

Irwin J. Slikin
Aetna

Dr. W. J. Spencer
Xerox Corporation

Dr. An Wang
Wang Laboratories, Inc.

Trustees

Charles Bachman
C. Gordon Bell
Harvey D. Cragon
Robert Everett
Dr. C. Lester Hogan
Theodore G. Johnson
Andrew Knowles III
John Lacey
Patrick McGovern
George Michael
William Millard
Robert Noyce
Kenneth Olsen
Brian Randell
Kitty Seifridge
Michael Spock
Erwin Tomash
Paul Tsongas
Maurice Wilkes

Executive Committee

David Donaldson,
Chairman
Gwen Bell
Theodore Johnson
Mitchell Kapur
Ralph Linsalata
Nicholas Pettinella
Jonathan Rotenberg
Paul Severino
Hal Shear
Ronald Smart

Annual Donors

Digital Equipment
Corporation for
major annual support

Sustainer -- \$10,000 or more

Hewlett-Packard, Co.
IBM
Institute of Museum
Services
Massachusetts Council
for the
Arts and Humanities

Benefactor -- \$10,000

American Express
Foundation
Raytheon Company
Sanders Associates
The Travelers
Xerox Corporation

Patron -- \$3,000

Addison-Wesley
Bitstream
Boris Color Labs, Inc.
Burroughs Corporation
Coopers & Lybrand
Delta Translation
DECUS
Dentsu, Inc.
Draper Snow and
Gaston Snow & Ely
Bartlett
General Computer Co.
Gourmet Caterers, Inc.
Honeywell
IEEE Computer Society
Lotus
Major Computer, Inc.
MASSCOMP
McGraw-Hill, Inc.
Microsource Financial
The MITRE
Corporation
Phoenix Software
Prime Computer Corp.
The Prudential
Ropes & Gray
Sun Microsystems
Symbolics, Inc.
/u/s/t/ group

Contributor -- \$1,000

Access Technology
Adage, Inc.
Adelle Corp.
Analog Devices, Inc.
Analogic Corporation
Arthur Andersen, Inc.
Arthur D. Little, Inc.
Autographix
Automatix
Bank of Boston
Bank of New England
BASF
Baybanks
Bolt Beranek & Newman
Boston Safe Deposit
BusinessLand
Dane, Falb, Stone & Co.
Deloitte Haskins & Sells
Eastech
E.M.C. Corporation
Executives, Inc.
Foley Hoag & Elliot
Grafik Communications
Ltd.
Genrad
Goldman, Sachs & Co.
Gould, Inc.
Greylock
GTE Laboratories, Inc.
Hyams Trust
Index Technology,
Innova
Intel Corporation
Interface Group
LTX Corporation
Manufacturers Hanover
MediVision, Inc.
Mentor Graphics
MICOM-Interlan, Inc.
Micro Control Systems
NEC Corporation
Pathway Design, Inc.
PC Magazine
Peat, Marwick, Mitchell
Peil, Rudman
Polesse-Clancy, Inc.
Price Waterhouse
PSDI
Russell Reynolds
Shawmut Corporation
Scitex America
Standard Oil
SYMEDCO, Inc.
Teletronics
Teradyne
VM Software
Warner & Stackpole
XRE Corporation

Donor -- \$500 or more

Rory Duncan
Tom Eggers
Dan L. Eisner
Alan E. Frisbie
Tom and Rosemarie Hall
M. Ernest Huber
Robert Kahn
Martin Kirkpatrick
Raymond Kurzweil
Andrew Lavien
Linda J. Phillips
Paul R. Pierce
Ann Roe-Hafer
Jonathan Rotenberg
O. & K. Seifridge
Seth Stern
William Steul
Leo Yochim.

Sponsor -- \$250

Isaac Auerbach
Jordan Beruch
Graham Beachum
G. C. Beiden, Jr.
Richard J. Clayton
Richard Corben
David N. Cutler
Donald R. Dorykin
Nick De Wolf
James B. Deaderick
Delta Management
Philip H. Dorn
Bob O. Evans
Larry Forte
Braniko Gerovac
John Gilmore
Roberto Guatelli
Lawrence J. Kligattien
Bob King
Marion Kowalski
Sheldon Lavde
Eli Lippoon
Carl Machover
Joe W. Matthews
Tron McConnell
Steven Nevins
Joseph M. Newcomer
Anthony Oettinger
James V. Patton
James A. Pitts
J. Eric Pollack
Linda & David Rodgers
Thomas S. Roy II
Michael J. Sarnick
Charles A. Stott
John V. Terrey
Michael Tomasic
G. Michael Uhler
Allan L. Wallack
Andrew Wilson.

Friend -- \$100

Kenneth R. Adcock
Timothy Anderson
Roland Arndt
Professor Arvind
Richard G. Bahr
Steve Baine
Dawn R. Banks &
Robert M. Praetorius
Mario Barbacci
Steve F. Barneby
John C. Barstow
Alfred M. Bertocchi
Lois J. Bizak
Bantronics
Daniel S. Bricklin
Robert E. Briney
Fred & Nancy Brooks
D. F. Brown
Gordon S. Brown
John and Ann Brown
Les Brown
Roger M. Buoy
W. Carlson
Maria L. Carr
George Chamberlain
George Champine
M.H. Coden
James F. Cody
Howard J. Cohen
Michael J. Coppolino
Howard E. Cox, Jr.
Michael Cronin
Daniel Crowley
CSDP
James Cudmore
Paul Curran
Harvey Deitel
F. Demco
Lucien Damino
Ditragiani Family
Patrick M. Donini
Theodore Drapos
Dick Dunnington
R. DuVal
Esther Dyson
Joseph J. Eachus
Richard J. Eckhouse and
Ruth Maulucci
William Elliott
Lucian Endicott
Thelma Estrin

Andrew Feil
Geoffrey Feldman and
Shaon Lipp
Harold Fitch
Robert France &
Ruth Doan
J. Thomas Franklin
Clark Frazier
Daniel Freedman
Kevin and Judith Galvin
Bruce Gilchrist
David Goodman
Roger H. Goun
Stephen Gross
Paul C. Guglietta
Jerrie A. Haddad
J. Scott Hamilton
James S. Harvison
Frank E. Heart
Daniel and Nancy Heff
Thomas L. Hohmann
Grace M. Hopper
Nancy S. Horie
Robert Ingham
Roy C. Johnson
Charles A. Jortberg
Richard M. Karoff
Bryan S. Kocher
Josh and Mabel Kopp
Neal Koss
Alan and Judith Kotoik
Sieglinde Kress
Stanley Kugell
Robert Laman
Curtis Laroock
Tsvi Lavi
Grace Leahy
L. Lein & B. Kuipers
John R. Levine
John V. Levy
Joseph L. Levy
Reed Little
George Logemann
Carl D. Lowenstein
Arthur Luehrmann
Joseph MacDonald
Julius Marcus
Barry Margolin
Andrew H. Mason
Robert O. Mason
Sibyl Masqueller
J. Steverson Massey
Robert Mayer, Jr.
Richard McCluskey
F. Warren McFarlan
William McLean
Todd Medlock
Myron Mendelson
Jeanette Middaour
Charles Minter
Allen Moulton
J. Craig Mudge
Isaac R. Nassi
Lee Neal
Tim K. Nguyen
Bernard J. Nordmann
H. Edward Nyce
Lawrence & Pauline
Oliva
Joseph A. Pallone
Kenneth D. Patterson
Juan Pineda
Michael Picque
James N. Porter
John H. Porter
David Potter
Robert C. Probasco
Brendan Reilly
Audrey Reith
Daniel Rose
David Rose
Thomas S. Roy II
Howard Salwen
Bennett Schwartz
Andrew Scott
Curtis A. Scott
Seibel Software
Aaron Seidman
R. & M. Shamel
W. Lee Shevel
John J. Shields III
Charles Sholfield
W. Otin Sibert
Dan Siewiorek
Diane J. Sliba
Allen G. Schneider
Max J. Steinmann
Hugh W. Stewart
Robert and Diane
Stewart
J. Michael Storie
David Tarabar
Paul Tedesco
William R. Thompson
Warren G. Tisdale
Noah E. VanDenburgh
Thomas VanJohn
Thomas E. Weimers.
John D. Wick
Hugh Wilkinson III
Kevin Willoughby.
Roy Wilson
Richard T. Witek
Frederic G. Withington
Paul Wittman
William A. Wulf
D. L. Wyse.

Capital Campaign

Thanks for the Memories of...

64K or more

Apollo Computer, Inc.
C. Gordon Bell
Control Data Corporation
Cullinet
Data General
Carver Mead
Kenneth Olsen
John William Poduska
Wang Laboratories

32K or more

American Telephone &
Telegraph
Bank of America
Henry Burkhardt
ComputerLand
Kenneth Fisher
Gardner Hendrie
Mitchell Kapur
International Data Group
Russell Noftsker
Robert Noyce
Robert M. Metcalfe
Fontaine K. Richardson

16K or more

Anonymous
Clark Baker
The Boston Globe
Howard Cannon
Doug Drane
David K. Dyer
Bruce Edwards
August Klein
James L. McKenney
NEC Corporation
David & Pat Nelson
Paul & Katherine
Severino
Ron Smart
William Spencer
Charles E. Spork
Ivan Sutherland
Chris Terman
Stephen Watson

8K or more

AFIPS
Harlan E. & Lois
Anderson
Erich & Renée Bloch
Winston R. Hindle, Jr.
Index Systems
Theodore & Ruth
Johnson
John Allen Jones
Stan Olsen
Russell Planitzer
Doug Ross
Software Results Corp.
Erwin Tomash

American Management
Systems, Inc.
Charles & Connie
Bachman
Gene Brewer
Roger and Mary Cary
R. Steve Chehey
Robert & Eleanor Chinn
Pat Clark
Robert G. Claussen
William Congleton
Alex d'Arbeloff
Arnaud de Vitry
David Donaldson
Robert Everett
Ford Motor Company
Joy W. Forrester
William Foster
General Systems Group
Gaston Snow & Ely
Bartlett
Peter Hirschberg
Houghton Mifflin
Company
International Computer
Ltd.
Jeffrey Kaib
Allan Kent
Jack S. Kilby
Andrew C. Knowles III
David J. A. Koogler
Edward and Debbie
Kramer
John W. and Edna W.
Lacey
Liberty Mutual
Insurance Company
Ralph and Linda
Linsalata
Robert Lucky
John Norris Maguire
Richard D. Mallory
Thomas and Marian
Marill
Daniel D. McCracken
Thomas and Elizabeth
McWilliams
Meditech
Allen Michels
Microsoft
Robert M. Morrill
New York Air
Nolan Norton Company
John L. Payne
Nicholas A. Pettinella
Edward G. Perkins
Robert M. Price
Regis McKenna, Inc.
Ben Robelen
Jean E. Sammet
Grant Saviers
Hal Shear
Alan F. Shugart
Richard L. Sites
Del Thorndike and
Steve Teicher
3Com Corporation
Jean De Valpine
Charles P. Waite
Harvey W. Wiggins, Jr.
William Wolfson

 **The
Computer
Museum**

300 Congress Street
Boston, Massachusetts 02210



The President's Letter

Gwen Bell, President

ON ONE HAND...

Pocket Calculators Then and Now

Today we almost take pocket calculators for granted. Yet, the inexpensive and convenient electronic calculator we use today is less than fifteen years old.

"How many sheep do I have?"

"How much are three loaves of bread?"

The need to answer such questions is nearly as old as human civilization. Throughout history, people have developed ideas and devices to help them work with numbers and to answer such questions quickly and accurately. People have used many different materials to make handy calculators, from sticks and stones, to gears and electrons.

This issue of the Report is based on an exhibit that allows you to journey through the history of the pocket calculator. You will meet the people who have used pocket calculators in the past and discover the problems they solved. At the exhibit you can try your hand at using their calculators. While in this publication, you will learn more of the anecdotes associated with the artifacts.

The idea of the exhibit was conceived on a trip to London where I saw many 18th and 19th century pocket calculating devices. Then it was made possible by a grant from the Hewlett Packard Foundation. It was developed by Greg Welch after his graduation from Harvard and before leaving on his Shaw Travelling Fellowship to visit the science museums of Europe. The exhibit and this report were designed and produced for the Museum by Michael Sand, Inc.

On One Hand is to be the Museum's first travelling exhibit. It will help us bring the Museum to you. The exhibit, appropriate for Science and Children's Museums, University Galleries, and Corporate Exhibitions, is expected to be available in the summer of 1987. Please let us know if you wish to suggest a placement for the exhibit.



The First Pocket Calculator: The human hand was used as a calculator long before the first pocket. Many cultures throughout history have used hands to calculate and represent large numbers. Finger counting often led to the development of number systems. Indeed, most number systems around the world are based upon groupings of five or ten. This diagram from the 8th century A.D. illustrates a system of elaborate finger counting used in Europe during the Middle Ages. Numbers up to 1,000,000 could be represented by various positions of the fingers and hands.



Step 1

You're an ancient shepherd. This is your flock, about to leave the enclosure for a day of grazing.

Step 2

This is your bag of pebbles. Feel the pebbles in the bag as you study the flock, and match one pebble to each sheep. Remember, counting isn't fair. Do you have your whole flock?



Step 3

Now, this is your flock returning at the end of the day. Have you lost any sheep?



Shepherd's Pebbles. Mesopotamia, circa 1000 B.C. Shepherds of old let their sheep graze free by day, and at night put them into an enclosure. The problem they faced was knowing if they had all their sheep. Did one wander away while grazing? Was one stolen in the night?

To keep track of their flock, they used a bag of pebbles and a bowl. In the morning they put one pebble in the bowl for every sheep that left the enclosure. At night, they put the pebbles back in the bag, one by one, as the sheep returned. If there were pebbles left over, they went looking for sheep.

The shepherds weren't counting as they did this. They weren't thinking "one, two, three...." They were thinking "sheep, sheep, sheep...." As a result, they did not know how many sheep they had altogether, or how many pebbles either. They just knew that there should be as many sheep as pebbles.

This one pebble/one sheep system had its drawbacks. For one, a big flock meant a very heavy bag of pebbles. For another, someone might manage to steal a sheep and a pebble, and the shepherd would never be the wiser. Still, the system worked for ancient



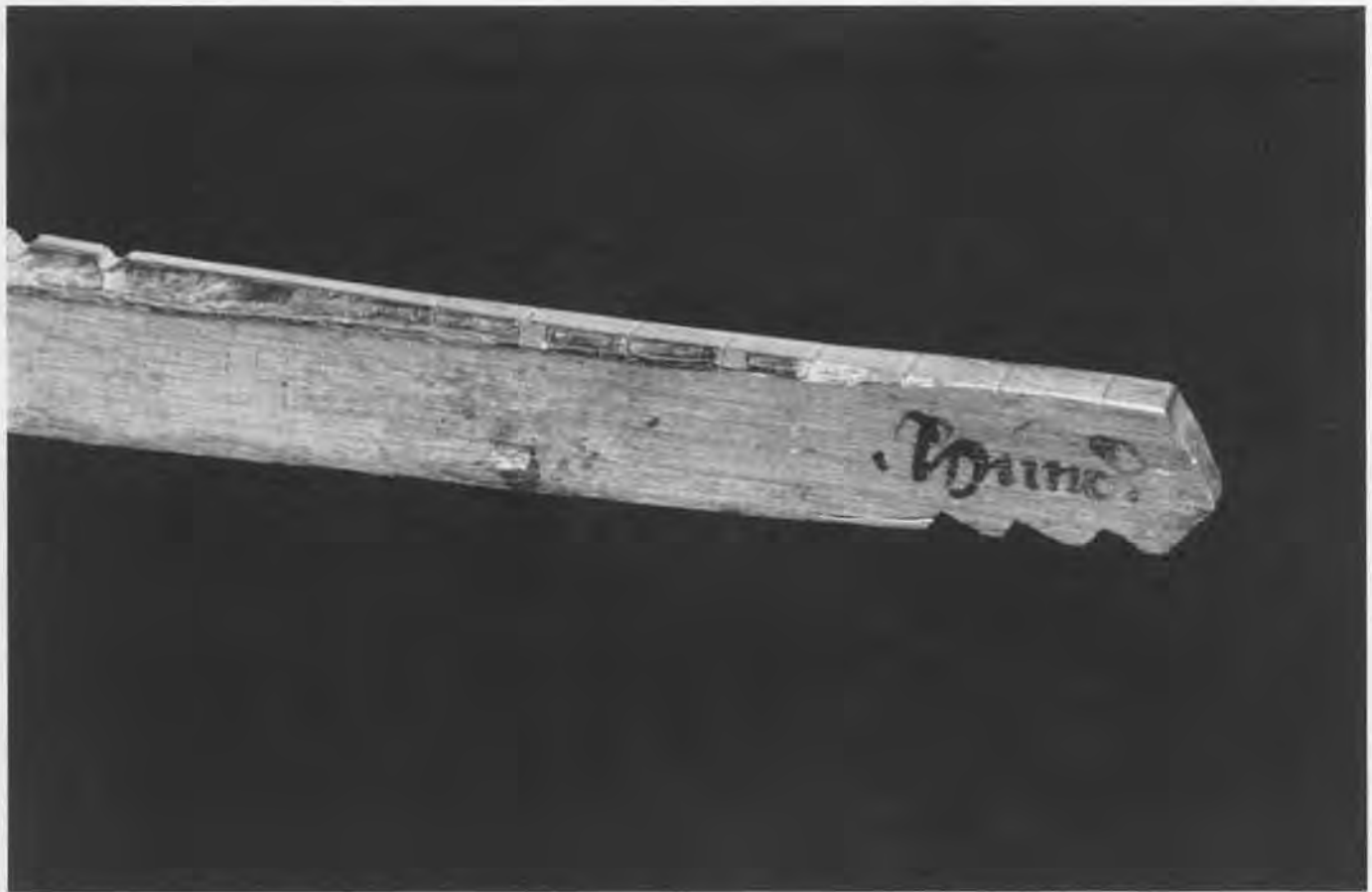

shepherds, and it continues to work for some of their modern-day descendants. And versions of the system are seen in some religions today, which use beads (like a rosary) to keep track of repeated prayers. Cultures have had to learn to count, just as children do. They have had to learn numbers. A number allows people to keep track with a mental idea of quantity. So instead of carrying around a bag of seventeen pebbles, you carry in your memory the number seventeen.

Cultures that count made an important modification in the one-pebble/one-sheep system. They could let different objects stand for different quantities. They did not necessarily have a way to write out the number, but they had the idea, they had a way to represent the idea, and most invented some sort of device, some sort of pocket calculator, that would help them work with numbers. As early as 3500 B.C. in China, rods of bone, wood, or ivory were arranged in various patterns to represent numbers. In ancient Rome, styli were used to scratch numbers into wax tablets for both calculation and storage.

Tally stick: Cultures across the globe carved records on sticks. The earliest known "tally" sticks date from 30,000 B.C.

Notched tally sticks such as this one were used to store financial records in England from the 13th to the 19th century. The pattern of the notches represents a quantity of money: large notches indicate pounds, smaller ones shillings, and scratches pence. On the remaining faces of the tally, opposite each other, were the name of the payer and the date of the transaction, written in ink by an officer called the writer of the tally. After a transaction was recorded, the stick was split in half down its length, and one half was given to each party as a receipt. The practice was ordered to be discontinued by the Act of 1782 that came into force in 1826. Subsequently, the House of Lords discovered that it had warehouses full of tally sticks and used them as fuel in their chambers. Echequer Tallies are extremely rare today. From the Samuel S. Dale Collection, Rare Book and Manuscript Library, Columbia University.

A competition between the Hindu-Arabic form of mental and paper arithmetic that we use today and Roman numeral figuring using jettons. The dismay of the jetton user shows graphically who is winning. The mid-18th century saw the widespread availability of paper, of printing, and the use of the Hindu-Arabic number system with the simultaneous decline of the use of Roman numerals and their computation with jettons.

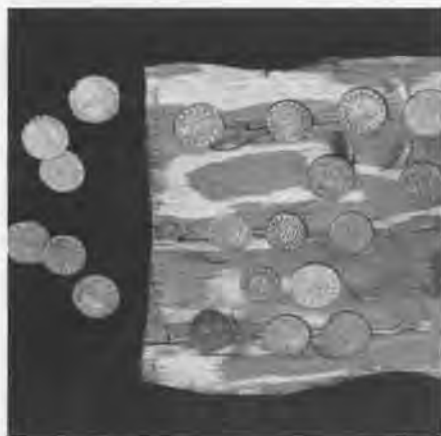

These copper jettons are from 14th-century Italy. The designs on jettons were often symbols of different trades or coats of arms. Depending upon the wealth of the owner, jettons were produced in metals varying from copper to gold but they were not coins. In fact, a new set of jettons was a customary New Year's gift. The old set would then be thrown in a river, symbolically clearing last year's accounts.

Remnants of jettons remain with us today. Merchants had boards in their shops on which to toss their jettons to calculate bills; stores today still have "counters." From the collection of Gwen and Gordon Bell.

Jettons. During the Renaissance, Europeans counted with Roman numerals. But even for people accustomed to using them, Roman numerals are not easy to calculate mentally, and paper and pens were hard to come by. Merchants used copper tokens called "jettons" to calculate prices.

The jettons were moved about on lines. Merchants could draw the lines on the ground or scratch them on a table. The lines represented different values of ten: ones, tens, hundreds, and so on. For intermediate values, like five or fifty, a space was left between the lines. In the same way that you know immediately what is meant by \$1.98, the Renaissance buyer and seller immediately recognized the price by the position of the jettons on the lines.

Until 1700, calculating tokens were common in Europe. The tokens usually derived their name from moving them about the lines while calculating: the word "jettons" comes from the French verb "jeter" meaning "to throw." Adept calculators must have made their jettons fly across their counting boards! By the mid-18th century both the Roman numeral system and jettons had disappeared from everyday use.



The Japanese "soroban" has sharp edges to its beads and only one bead in *heaven* and four beads in *earth* to make operations faster. From the collection of the Peabody Museum of Salem.

The soroban has not declined in use since the advent of its rivals the calculator and computer. In some banks, the daily computerized totals are double checked with a soroban. In learning the soroban, students learn to visualize the position of numbers. The soroban champion, Ms. Nishida, can add eight ten-digit numbers in less than ten seconds simply by visualizing the position of the beads in her head. In fact, the Japanese claim that learning the use of the soroban can increase a student's I.Q.

Abacus. Most eastern countries used an abacus of some sort. It emerged from the Middle East sometime after 500 A.D. and was based on a system in which pebbles were moved around on the ground to represent numbers and perform calculations. (The word abacus is from the Semitic word "abaq," meaning dust.) The Chinese developed a version that they called a *suapan*. The Japanese modified the *suapan* and called it a soroban.

An abacus is rather similar to jettons. The difference is that instead of scratching lines and carrying loose jettons, the tokens were strung on wires, and then framed. The abacus became the indispensable calculator for eastern merchants. It was easy to carry. And for the skilled user, it is very fast. People who use an abacus learn to recognize numbers simply by looking at the position of the beads.



The Chinese "*suapan*," or "counting tray," has round beads and is divided into two sections. The top section is called *heaven* and contains two beads, each worth five units. The bottom section is called *earth* and contains five beads, each worth one unit. The *suapan* was used in China by the 1300s, and it became widely popular in 1593 when the mathematician Chen Ta-wei published a book on abacus computation. The abacus is still such an important part of Chinese culture that May 10 is celebrated as National Abacus Day. From the collection of Gwen and Gordon Bell.

These calculations were performed by Johannes Kepler for his *Ephemerides*, dedicated to Napier for his invention of Logarithms. These were typical of the long hand arithmetic used to numerically describe the movements in the heavens.

The concept of the pocket book of tables started with the development of printing itself.

(1) The 1683 table of trigonometric values was useful to navigators, surveyors, astronomers, mathematicians and architects. Such tables eliminated the need to constantly calculate the trigonometric values of numbers. However, few tables were free from mistakes, and corrections were often put in by hand. From the collection of Gwen and Gordon Bell. (2) This set of logarithms tables was compiled in 1839 in England by The Society for the Diffusion of Useful Knowledge. To multiply two large numbers an astronomer would look up the numbers in the table, and add the listed logarithm values. The number in the tables that corresponded to the sum of the logarithms was the answer to the original multiplication problem. From the collection of the IBM Corporation. (3) Easily carried in a shirt pocket, Thompson and Thomas's *Electrical Tables and Memoranda*, published in London in 1898, was a handy reference for the electrical engineer wherever he went. From the collection of Gwen and Gordon Bell.



Scientists' Instruments The year 1670 marked the first recorded appearance of Halley's Comet. A seventeenth-century astronomer bent on knowing the heavens and such predictions as the recurrence of the comet, faced very complicated calculations. He often needed to multiply vast numbers to describe the motions of the planets and the stars.

Astronomers were greatly aided by the Hindu-Arabic numeral system introduced to Europe around the fifteenth century. This number system made the sophisticated arithmetic of science possible. In addition, a wide variety of calculating tools were developed that stored information including the development of printing and the production of books of tables. These tools saved the scientist time and increased the accuracy of his calculations.

Napier's Bones were invented in 1617, when John Napier, a Scottish baron, published a book describing the device. Within a few years, it had spread throughout Europe and as far as China. Napier's Bones (so-called because they were often made of bone) were rods with multiplications tables on them. At the time, educated people often knew their multiplication tables only as far as 5 x 5.



The 18th century scientist/scholar/gentleman had a number of elegant devices that could be carried in the pocket and be the mark of a learned man. These include such items as (1) A pocket set of drawing instruments in an elegant shagreen and silver case would have been useful in producing a map of the heavens. From the collection of Gwen and Gordon Bell. (2) A portable sun dial, made in Augsburg, Germany, during the middle of the 18th century, was a precursor to the pocket watch, for telling the time of day. From the David Eugene Smith Collection, Rare Book and Manuscript Library, Columbia University.

(3) An Arab astrolabe that could be used to determine the position of the stars and sun on any day of the year. The spikes on the top piece of brass represent the major stars and could be turned about the brass plate below it. The etching on the plate is a map of the heavens. Different plates are used depending upon the user's latitude. From the David Eugene Smith Collection, Rare Book and Manuscript Library, Columbia University. (4) Napier's Bones in its secure case. From the collection of Gwen and Gordon Bell.



Napier's Bones were used for multiplication, division, and square and cube root problems. It was simple to arrange the rods to solve complicated problems. In the Museum's exhibit visitors utilize a super-sized model of the device.

The Webb Adder was patented in the United States in 1869. Any two-digit number could be directly entered on the large gear with a stylus. When the large gear had made one complete revolution it advanced the smaller gear one place, thus "carrying" to the hundreds place. Gift of Gwen and Gordon Bell.



The oldest mechanical pocket calculator, designed by Englishman Samuel Morland (1625-1695) in 1666, avoided some of the mechanical problems that plagued the Pascaline. Morland did not link together the gears for different digits. Instead, each time a digit gear completed a full turn it advanced the small gear above it one place. At the end of a problem the small gears indicated how much to add (carry) to the next digit places. From the collection of the IBM Corporation.

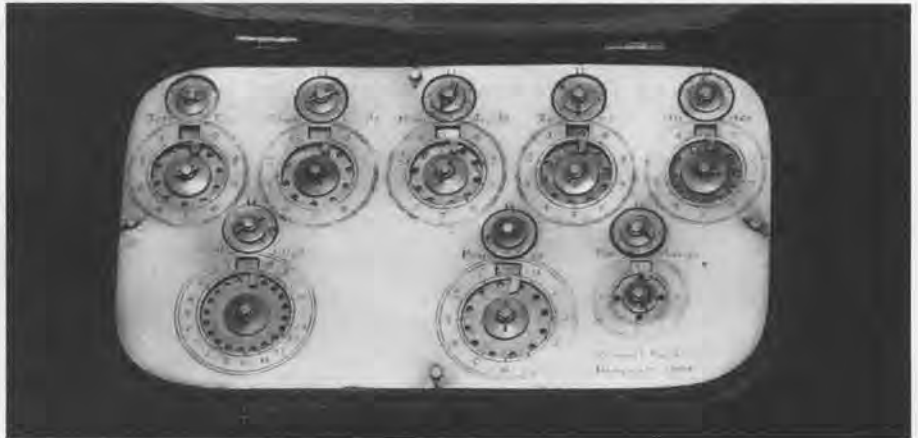

The Addiator was a very inexpensive and widely-sold pocket calculator. Introduced in 1920, over 100,000 were sold the first year. The Addiator was not truly mechanical in operation. The user added by sliding either up or down strips of metal with numbers marked on them. No gears or inter-linked parts were involved. The basic idea was first invented in 1889 by a Frenchman named Troncet. Troncet called his calculator the Arithmographe. From the collection of Gwen and Gordon Bell.

Digital Adders. Most mechanical adders use gears to "count." As you enter a number the machine "counts" the number of gear teeth that you advance. Calculating by counting is called digital calculation. The idea of using a stylus to advance gears to perform addition dates to 1642, when the French mathematician Blaise Pascal (1623-1662) invented a calculator called the Pascaline. Many mechanical calculators built for the pocket operated on similar principles.

The gears only went in one direction and the machines only held one register. Subtraction was carried out by 9's complement arithmetic, and multiplication by repeated addition. These were able to be widely produced for a very low cost and became the mechanical helper for many people.



In the background of this etching by William Hogarth, a mob is attacking a tax assessor's office and tearing down its sign. The tax levied on alcohol was not very popular and it led to many political clashes. Its unpopularity was not just due to the tax, but to the precision of the devices for measuring the amounts and the inability to evade the assessor in the traditional ways.

Slide Rules. Edmund Gunter (1581-1626) was the first to construct a scale rule that could be used to multiply. He divided his scale according to Napier's principle of logarithms, so that multiplication could be done by measuring and adding lengths on the scale. In about 1630 William Oughtred (c.1574-1660) improved upon Gunter's idea by fixing two rules together so they could slide against one another.

Slide rules were not the only widely used analog calculators. Quadrants evolved from instruments used for measuring angles between stars in ancient Babylonia. In the 16th century scales were etched on these devices which made them more useful to laymen as calculators. Gunter was one of those most responsible for the quadrant's improvement and use. Other popular analog calculators were the proportional compass and the sector.



The "Unique Log-Log" slide rule, and the later Dietzgen Redirule are slide rules designed for the shirt pocket. In general, the shorter the slide rule, the less accurate it is. From the collection of Gwen and Gordon Bell. Gift of I. Bernard Cohen.

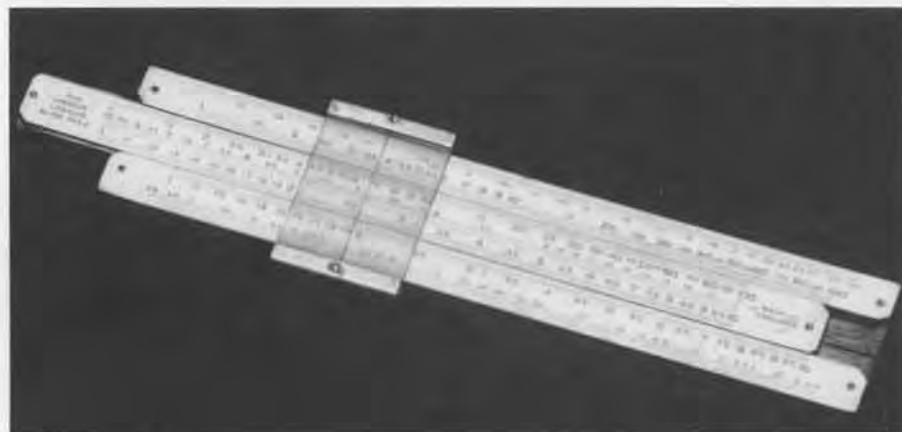
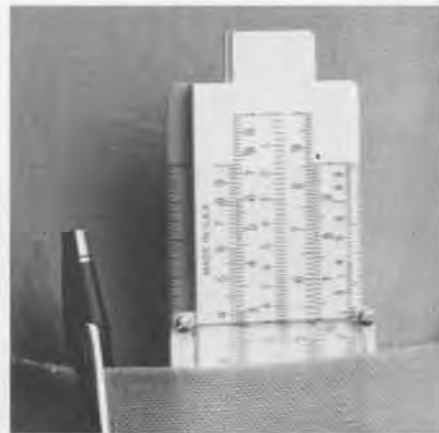

In the seventeenth century, the English government devised an efficient system for taxing ale and wine by producing a slide rule to help the assessors calculate the tax, right at the barrels. The alcohol tax was levied only on the amount that had been sold, and the slide rule allowed the assessor simply to determine the liquor that remained in the barrel. He used a gauging rod, like a dip stick in a car.

The first such slide rule was described in 1683 by Thomas Everard. In 1739 Charles Leadbetter improved upon the design by adding scales that could calculate the contents of a keg whether it was standing on end or lying on its side. The rule was used with a folding gauging rod to measure the depth of liquor in a keg. Sometimes tax assessors had their rule and gauging rod fit into a cane; not quite a pocket calculator but certainly of the same notion.

Slide rules were the work horse of scientific calculation for many decades. They were fast and reliable, and an experienced user could perform a long and complex calculation with ease.

Circular slide rules operated on the same principle as straight slide rules, but they took up less space. Both William Oughtred and his student Richard Delamain claim to have first thought of the circular slide rule. (1) A general circular slide rule. Gift of Stanton Vanderbilt. (2) This slide rule was used by pilots to estimate arrival times, and to calculate other aspects of their flight according to changing conditions. From the collection of Steve Kallis. (3) A bombardier would have used this slide rule to calculate the chances of destroying his target under various conditions. Gift of David Martz. (4) Harvard Project Physics circular slide rule could be slipped into a student's textbook. Gift of I. Bernard Cohen. (5) This homemade version made by Charles Bachman helped the family compare the price of goods at the grocery before the days of unit pricing. Gift of Charles Bachman.

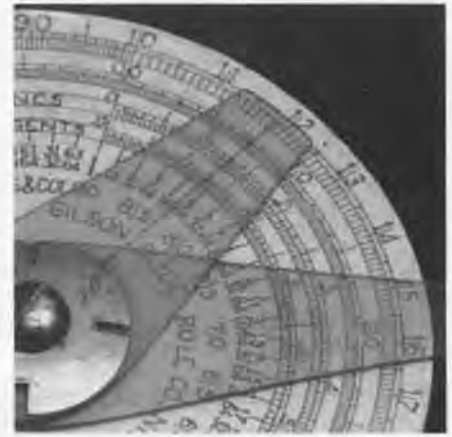
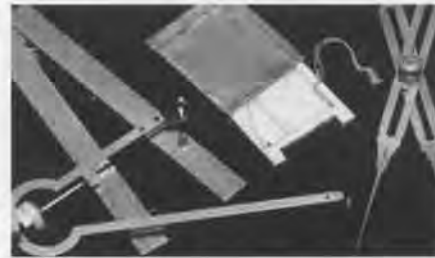

A variety of pocket-sized analog calculating objects developed for use by scientists and engineers with a wide variety of specialized products for different uses. (1) By tracing the outline of a curve, a planimeter can measure the area contained within even the most twisted curve. These pocket sized devices were often carried by airplane engineers to determine various surfaces. From the collection of Gwen and Gordon Bell. (2) An engineer could perform a wide variety of mathematical calculations by adjusting the position of the hinge and by measuring the distances along the scales marked on the arms of this sector. The sector evolved from a calculator invented by Galileo for use in aiming cannons. From the collection of Gwen and Gordon Bell. (3) This simple ivory quadrant was made in Italy during the early 19th century. It might have been used by an architect to perform calculations while on the site of a building. From the David Eugene Smith Collection, Rare Book and Manuscript Library, Columbia University. (4) By adjusting the position of the pivot nut on this proportional compass, architects and map makers could immediately change the scale of their drawings. If the nut was set at the line marked 2, then any line measured by the long points would be divided in half and represented by the distance between the short points. From the collection of Gwen and Gordon Bell

Slide rules had two drawbacks. First, slide rules were only as accurate as the fineness of their scales, because they were analog calculators and measured quantities. If the scale were any finer you could not read it. Notice how you have to estimate the position of a three-digit number on the scale. This degree of accuracy, however, was generally enough to estimate the answer to most scientific and engineering problems. Second, slide rules have no decimal points. The same mark can be read as 0.125, 1.25, 12.5, or 125. The user had either to keep track of the decimal point or to place it wherever it was reasonable when the problem was finished.

Until the 1970s, when an engineer wanted a quick answer to a problem, he usually reached for his slide rule. The slide rule was designed to simplify complicated calculations. Leather cases that could be clipped to the belt were often used by scientists to carry large slide rules with them wherever they went. The slide rule (or "slip stick" as it was nick-named) was the constant companion of engineers and scientists. Slung from the belt or stuck in the pocket, it was the mark of the serious scientist.



Electronic Calculators. By the mid-1970s electronic calculators reached the masses. The development of very small and cheap electronic circuits for computers during the late 1960s and early 1970s allowed small electronic calculators to be constructed and sold inexpensively. Over time, calculators became even more sophisticated, cheaper, and smaller.

Today electronic calculators can:

- store numbers and information like early pebble calculating systems and wax tablet records,
- add large numbers quickly like the abacus or Webb Adder,
- multiply rapidly like Napier's Bones, and the Curta,
- quickly find the values of mathematical functions like mathematical tables or slide rules,
- be programmed to perform complicated and lengthy calculations at the push of a button,
- perform whole new tasks such as translating languages and dialing phones.

The Hewlett-Packard HP-35 was the first scientific pocket calculator. It could very quickly and accurately perform many of the slide rule functions that were too complicated for simple four-function calculators. It was nicknamed the "electronic slide rule." Thanks to the speed of electronic circuits, the HP-35 could calculate the logarithm of a number at the push of a button. When introduced on February 1, 1972, the HP-35 cost \$395.

Prior to the first scientific calculator, the HP-35, finding the value of a function (such as the sine of an angle) meant looking it up in a table, or being satisfied with the limited accuracy of a slide rule. The HP-35 could instantly calculate the sine of an angle to ten decimal places. The same is true of other trigonometric functions and logarithms. Gift of the Hewlett-Packard Company

The Bowmar 901B, manufactured by the Bowmar Instrument Corporation and seen here in a version sold by Craig, was the first pocket-sized electronic calculator. Introduced at the end of 1971, the 901B could add, subtract, multiply and divide eight-digit numbers. It cost \$249.95. Gift of the Bowmar Instrument Company.

The Texas Instrument Corporation, which manufactured the circuits used in the Bowmar 901B, soon entered the market of pocket calculators. This 2500 Datamath is one of Texas Instruments's earliest electronic calculators. Texas Instruments is a large producer of calculators to this day. Gift of Ian Gunn.

Introduced in 1973, the Sharp EL-805 was one of the first calculators to use a Liquid Crystal Display (LCD). This substantially prolonged the life of its battery. Gift of Sharp Electronics Corporation.

The Hewlett-Packard HP-65 was the first pocket calculator that could read programs off magnetic cards. Programmability allowed the HP-65 to quickly perform a very long series of calculations without the user pressing many keys. This improved the power and convenience of the pocket calculator. When introduced in 1974 the HP-65 cost \$795. Gift of Darwin Smith.

This PD-100 is manufactured by SelecTronics and is only slightly thicker than a credit card. In addition to being a four function calculator that can convert directly into metric quantities, it can store up to 2,040 characters of text in a filing system, enough for up to 100 addresses. Gift of SelecTronics, Incorporated.



Early pocket calculators could only add, subtract, multiply, and divide. However, they offered speed and accuracy over most previous pocket calculators. The first electronic calculators were not cheap: the Bowmar 901B when introduced in 1971 sold for close to \$250. Within five years similar calculators sold for one-tenth as much, and far more powerful calculators were also available.

Some of the earliest aids to calculation were little more than means of recording quantities. Today micro-electronic circuits allow us to store large amounts of information in our pocket.



The Sharp EL-5500 III is a hand-held computer as powerful as many of the first desk-top personal computers. Designed for scientific uses, the EL-5500 III can be programmed in the computer language BASIC. Gift of Sharp Electronics Corporation.



The SL-800 Film-Card announced by Casio in 1983 was the first calculator to be truly the size of a credit card. It sold for less than \$20. The SL-800 contains no moving parts. A fully automated factory produces an SL-800 in only 2.8 seconds. Gift of Casio Incorporated.

The watch calculator is even more convenient than one in the pocket. In 1977, the first wrist watch calculator, the HP-01, came with a special pen to press its buttons and cost \$650. Only three years later, in 1980, Casio introduced its first watch calculator, the C-80. Today, wrist watch calculators are common, and many can store large amounts of information. From the collection of the Hewlett-Packard Company and from the collection of Casio Incorporated.

The Computer Museum in Tokyo

In August 1986, The Computer Museum participated in a 10,000 square foot exhibit called "Computer Wonderland" in the Seibu Department Store. In this single month over 400,000 people saw the exhibition starting with the Pascaline and going to the latest, hottest computer game.

The Museum provided the first section of the exhibition, including the Hollerith Machine for the 1890 Census, a Whirlwind and Sage exhibit, the Altair, the classic PDP-8, and other artifacts.

The evolution of computer games was one of the major features of the exhibition. This started with the Museum's recreation of SpaceWar! on the Macintosh and ended with a space game in which the player was encapsulated.

On two Friday evenings in the US (Saturday morning Tokyo time), CompuServe provided a free interactive satellite link between the Museum and the Department store. At the Museum, students from a computer camp conversed directly with young visitors in Tokyo via computer. The conversation quickly changed from their favorite computer programs to their favorite rock music.

Gwen Bell, who went over for the opening, observed that personal computers are not yet used as an educational and learning tool by most Japanese children, but primarily as a source of entertainment.

The exhibit was cosponsored by Dentsu, The Asahi Shinbun, ASCII and Seibu Department Store. Educational events for Tokyo's youth are jointly sponsored during the August school vacation, providing alternative learning environments within a commercial setting.

Artificial Intelligence and Robots

A new major exhibition

The exhibit, opening in June 1987, will be the first to display both state-of-the-art technology and the history and key artifacts of artificial intelligence and robotics. It is planned to make a significant contribution to the education and inspiration of the public in the realm of AI and robotics.

Your participation in this project in the form of ideas, hardware, software and effort is invited. Donations have been made by Carnegie Mellon University, Denning Mobile Robotics, Dragon, Hewlett Packard, Infomart, MIT, Stanford University, SRI International, SUN, Symbolics, Symantec, Texas Instruments, and Xerox, but much is still left to be accomplished.

Ideas, equipment, programs, artifacts, and hardware are needed to illustrate:

- Giving senses to machines;
- Robots and their evolution in fact and fiction;
- Expert systems;
- Game-playing;
- Natural language;
- AI Techniques; and
- Classic Machine Feats of Problem Solving!

Call or write Oliver Strimpel or Leah Hutten at The Computer Museum. And mark June 25th on your Calendar for the opening. *Your Participation is Invited!*

Software Archive Study

A planning study for a software archive, funded by Mitchell Kapor, is being undertaken by David Bearman President, Archives, Libraries and Museum Services Inc., Pittsburgh. This study, to be completed in June 1987, will lead to the inauguration of a software archive at the Museum.

The planning study will focus on the following issues:

- The criteria to identify the important events in the history of software and their application to a collection strategy;
- The constitution of an adequate record of software and its proper retention;
- The kinds of research that might be supported by the software archive;
- The relation between software and hardware ;
- The legal constraints, financial liabilities, physical budgets, and conceptual barriers to establishing a software archive.

This project will be reviewed by a panel including, Paulyn Heinmiller, Lotus Development Corporation, Professor Michael Mahoney, Princeton University, Arthur Mollala, The Smithsonian Institution, Arthur Norberg, The Charles Babbage Institute, and Helen Samuels, MIT Archives.

Members are invited to submit comments to David Bearman at The Computer Museum.



Calendar *Winter/Spring 1987*
Sundays at 4pm

- January 25** **Harold Cohen**
*How to draw three people in a botanical garden:
An Artificial Intelligence Program for Drawing*
- February 15** **Washington's Birthday Weekend**
Design and print your own fractal snowflake
- 21-22** **All Day: Kid's Computer Fair**
*Explore and experiment with new personal
computer software for family education and
entertainment.*
- March 8** **Marc Raibert**
Creating Legged Robots that Run
- 15** **25th Anniversary of SpaceWar!**
The first interactive computer game
Challenge the originators on the PDP-1
- 22** **SIGGRAPH '86-Part 1**
*Boston Public Premier of the new computer -
generated animation and graphics*
- 29** **SIGGRAPH '86-Part 2**
*Boston Public Premier of the new computer -
generated animation and graphics*
- April 11-12** **Museum Goers Month:**
*Celebrate families from Whirlwind to the
present; tours and handouts.*

COMING EVENTS

- May** A Spring Computer Circus and Auction

Talk by Jean Louis Gasse, Apple Computer
- June** Opening of the Artificial Intelligence
and Robotics Exhibition

The Computer Museum

The Computer Museum is a non-profit 501(c)3 foundation that chronicles the evolution of information processing through exhibitions, archives, publications, research and programs.

Museum Hours: *Summer:* Open daily 10-6, Friday 10-9. *Winter:* Open Tuesday-Sunday 10-6, Friday 10-9. Open Mondays during Boston school vacation weeks, 10-6. Closed Thanksgiving, Christmas, and New Years Day. Hours are subject to change.

Membership All members receive a membership card, free subscription to the Computer Museum Report, a 10% discount on merchandise from the Computer Museum Store, free admission and invitations to Museum previews. For more information contact Membership Coordinator at the Computer Museum, 300 Congress Street, Boston, MA 02210. Telephone (617) 426-2800.

Staff

- Dr. Gwen Bell, *President*
- Dr. Oliver Strimpel, *Curator*
Lynn Hall, *Registrar*
Dr. Leah Hutten, *Exhibits Developer*
Tom Merrill, *Exhibits Technician*
- Bonnie Turentine, *Education Director*
Kurt Levitan, *Education Assistant*
Gregory Schroeder,
Operations/Visitor Coordinator
- Mark Hunt, *Marketing Director*
Laura Goodman, *Store Manager*
Ani Benglian, *Assistant Store Manager*
Pat Fiorelli, *Public Relations Manager*
Linda Holekamp,
Communications Assistant
Kathleen Keough,
Functions Coordinator
- Michael N. Oleksiw II,
Development Director
Anne Jenckes,
Development Coordinator
Susan Versailles,
Membership Coordinator
Scott Reilly, *Development Assistant*
- Matt Murray, *Interim Business Manager*
Pat Pearson, *Accountant*
Wanda Alves, *Office Coordinator*

- Germain DRK, *Public Relations Advisors*
Jackson-Blum-Shapiro,
Advertising Consultants
Michael Sand, Inc,
Exhibit Planning Consultants
Kevin Burke, David Shopper,
Photography

YES! I want to become a Member of The Computer Museum.

\$20 Student \$45 Family \$250 Sponsor
 \$30 Individual \$100 Donor \$500 Patron

Members receive free admission for one full year, invitations to exhibit previews, advance notice of exhibitions and lectures, invitations to members-only events, a subscription to our exciting quarterly magazine, The Computer Museum Report, and a 10% discount in the Museum Store.

Enclosed is my check, made payable to **The Computer Museum** for \$ _____

or charge to: VISA MasterCard American Express

Card # _____ Expiration Date _____

Signature _____

Name _____

Address _____

City _____ State _____ Zip _____

Membership contributions are an important part of the funds that support the daily operations of the Museum. These contributions are tax-deductible to the extent provided by the law.

The Computer Museum, 300 Congress Street, Boston, MA 02210



The End Bit 0000000000000001

East meets West. The tradition of dual processors extends back to this French pocket calculator, circa 1800, that combines a set of Napier's Rods (not bones) and an abacus. The abacus could be used to add up the multiplications read from the rods. From the collection of the IBM Corporation. The Sharp EL-429 combines a traditional soroban with a modern, solar-powered electronic calculator. Gift of Sharp Electronics Corporation.

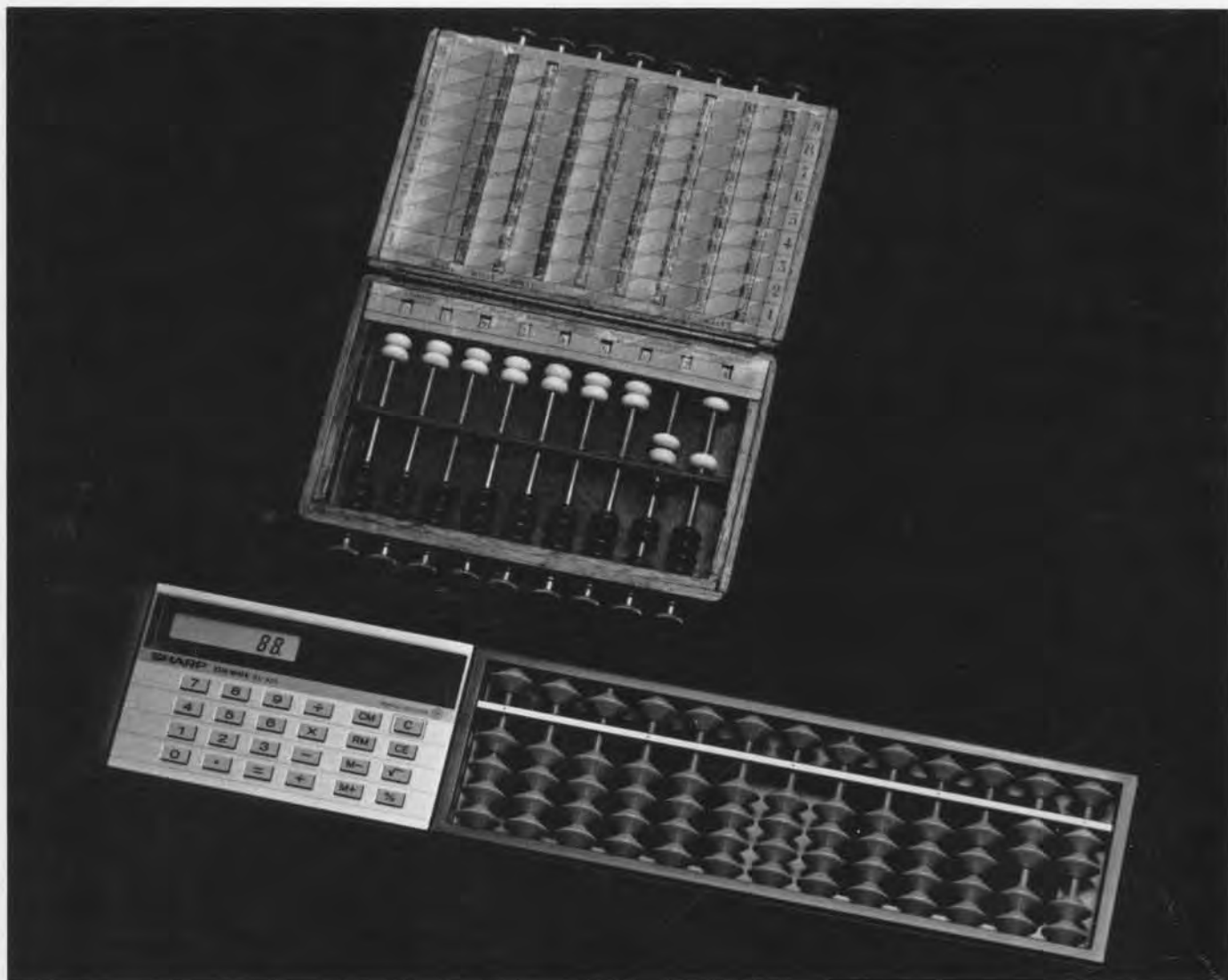

Address Correction Requested

Non-Profit
Organization
U.S. Postage
PAID
PERMIT NO. 110
FITCHBURG, MA
01420

The Computer Museum 300 Congress Street, Boston, Massachusetts 02210



THE COMPUTER MUSEUM REPORT

VOLUME 19
SPRING 1987

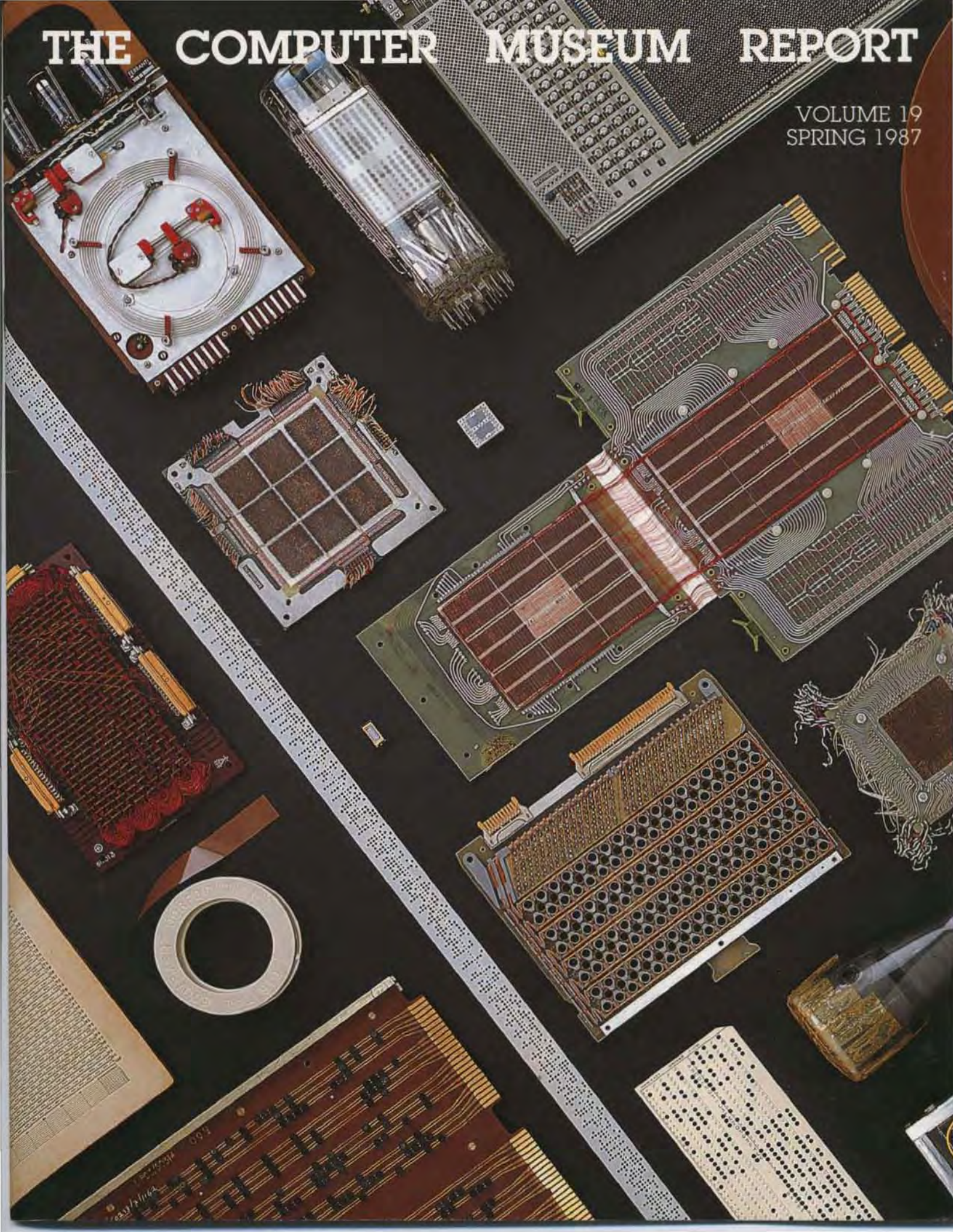

Board of Directors

Dr. John William Poduska, Sr.
Chairman
Stellar Computer, Inc.
Joseph F. Cashen
Executive Director
Dr. Gvern Bell
Founding President,
The Computer Museum
Erich Bloch
National Science
Foundation
David Donaldson
Ropes and Gray
John J. Evans
Manufacturers Hanover
Trust
Dr. Sydney Fernbach
Gardner Hendrie
The Sigma Partners
Arthur Humphreys
ICL
Mitchell Kapur
August Klein
MASSCOMP
Dr. Koji Kobayashi
NEC Corporation
Dr. Robert Lucky
AT&T Bell Laboratories
James L. McKinney
Harvard Business School
Dr. Carver Mead
California Institute of
Technology
Dr. Robert M. Metcalfe
3Com Corporation
Dr. Arthur P. Molesia
The National Museum of
American History,
Smithsonian Institution
Russell Nofstke
Symbolics
Nicholas Pettinella
Inometrics, Inc.
Jonathan Rotenberg
The Boston Computer
Society
Jean E. Sammel
International Business
Machines
Edward A. Schwartz
Digital Equipment
Corporation
Irwin J. Sitkin
Aetna
Dr. W. J. Spencer
Xerox Corporation
Dr. An Wang
Wang Laboratories, Inc.

Trustees

Charles Bachman
C. Gordon Bell
Harvey D. Crogan
Robert Everett
Dr. C. Lester Hogan
Theodore G. Johnson
Andrew Knowles III
John Lacey
Patrick McGovern
George Michael
William Milard
Robert Noyce
Kenneth Olsen
Brian Ramiell
Kitty Seidridge
Michael Spock
Erwin Tomash
Paul Tsongas
Marjorie Wilkes

Executive Committee

David Donaldson,
Chairman
Joseph F. Cashen
Gardner Hendrie
Theodore Johnson
Mitchell Kapur
August Klein
Ralph Linsakata
James McKinney
Nicholas Pettinella
John William Poduska, Sr.
Jonathan Rotenberg
Paul Severino
Hal Shea
Ronald Smart

Operating Grants and Corporate Support

Sustainer - \$10,000 or more

Digital Equipment Corp.
Hewlett-Packard, Co.
IBM
Institute of Museum
Services
Massachusetts Council
for the
Arts and Humanities

Benefactor - \$10,000

American Express
Foundation
Raytheon Company
Sanders Associates
Xerox Corporation

Patron - \$3,000

Addison-Wesley
Amdahl Corporation
Bitstream
Boris Color Labs, Inc.
Burroughs Corporation
Coopers & Lybrand
Data Translation
DECUS
Dentsu, Inc.
Draper Laboratories
Gaston Snow & Ely
Bartlett
General Computer Co.
Gourmet Caterers, Inc.
Honeywell
IEEE Computer Society
Lotus
Manufacturers Hanover
MASSCOMP
McGraw-Hill, Inc.
Phoenix Software
Prime Computer Corp.
Ropes & Gray
Sun Microsystems
Symbolics, Inc.
The Travelers
/u/s/i/ group

Contributor - \$1,000

Access Technology
Adage, Inc.
Adelle Corp.
Analog Devices, Inc.
Analogic Corporation
Apple Computer
Arthur Andersen, Inc.
Arthur D. Little, Inc.
Automatrix
Bank of Boston
Bank of New England
BASF
Baybanks
Bolt Beranek & Newman
Boston Consulting Group
Boston State Deposit
Cincom Systems, Inc.
Dane, Fall, Stone & Co.
Data Architects, Inc.
Deloitte Haskins & Sells
Eastech Management
E.M.C. Corporation
Executours, Inc.
Foley Hoag & Elliot
Grafik Communications
Ltd.
Genrad
Goldman, Sachs & Co.
Gould, Inc.
Greylock
GTE Laboratories, Inc.
Hyams Trust
Index Technology
Innova
Intel Corporation
Interface Group
LTX Corporation
MediVision, Inc.
Mentor Graphics
MICOM-Interim, Inc.
Micro-Com
Micro Control Systems
NEC Corporation
NYNEX Service Company
Peat, Marwick, Mitchell
Peil, Rudman
Price Waterhouse
PSDI
Russell Reynolds
Shawmut Corporation
Sclax America
Standard Oil
Sterling Hager
SYMCO, Inc.
Telectronics
Teradyne
VM Software
Warner & Stackpole
XRE Corporation

Donor - \$500 or more

Roy Duncan
Tom Eggers
Dan L. Eisner
Alan E. Frisbie
Tom and Rosemary Hall
M. Ernest Huber
Robert Kahn
Martin Kirkpatrick
Raymond Kurzwel
Andrew Larvin
Linda J. Phillips
Paul R. Pierce
Ann Roe-Hater
Jonathan Rotenberg
O. & K. Seidridge
Thomas F. Stephenson
Seth Stern
William Sterl
Leo Yochum

Sponsor - \$250

Isaac Auerbach
Jordan Baruch
Graham Beachum
G. C. Belden, Jr.
Richard J. Clayton
Richard Corben
David N. Cutler
Donald R. Daykin
Nick De Wolf
James B. Deardenck
Delta Management
Philip H. Dom
Bob O. Evans
Larry Forte
Branko Gerovac
John Gilmore
Roberto Guatelli
Lawrence J. Kugalen
Bob King
Marion Kowalski
Sheldon Lavde
Eli Lippson
Carl Machover
Joe W. Matthews
Tron McConnell
Steven Nevins
Joseph M. Newcomer
Anthony Oettinger
James V. Patton
James A. Pitts
J. Eric Pollack
Audrey Reith
Linda & David Rodgers
Thomas S. Roy II
Michael J. Sarnak
Charles A. Stott
John V. Teney
Michael Tomasic
G. Michael Uhler
Christian Walker
Allan L. Wallack
Andrew Wilson

Friend - \$100

Kenneth R. Adcock
Timothy Anderson
Roland Arndt
Professor Arvind
Richard G. Bahr
Steve Baue
Dawn R. Banks &
Robert M. Praetorius
Mario Barbaac
Steve F. Barneby
John C. Barstow
Alfred M. Bertocchi
Lois J. Bizak
Bontronics
Carol Botteron
Daniel S. Bricklin
Robert E. Briney
Fred & Nancy Brooks
D. F. Brown
Gordon S. Brown
John and Ann Brown
Lawrence Brown
Les Brown
Roger M. Buoy
W. Carison
Mara L. Carr
George Chamberlain
George Champine
M.H. Coden
James F. Cody
Howard J. Cohen
Michael J. Coppolino
Howard E. Cox, Jr.
Michael Cronin
Daniel Crowley
CSDP
James Cudmore
Paul Curran
Randall Davis
Harvey Deitel
F. Demeo
Lucien Dimino
Diargiani Family
Patrick M. Donini
Kathleen Doreau
Theodore Drapes
Dick Dunnington

R. DuVal
Esther Dyson
Joseph J. Eachus
Richard J. Eckhouse and
Ruth Marucci
William Elliott
Lucian Endicott
Thelma Estrin
Andrew Farber
Andrew Felt
Geoffrey Feldman and
Sharon Lipp
Harold Fitch
Philip Fox
Robert France & Ruth
Doan
J. Thomas Franklin
Clark Frazer
Daniel Freedman
Kevin and Judith Galvin
Bruce Gee
Bruce Gilchrist
David Goodman
Roger Gould
Roger H. Goun
William Graustein
Stephen Gross
Paul C. Guglietta
Jerrie A. Haddad
J. Scott Hamilton
James S. Harvison
Frank E. Heart
Daniel and Nancy Heff
Paulyn Heilmüller
Thomas L. Hohmann
Grace M. Hopper
Nancy S. Hone
Robert Ingham
Interbase Software Corp.
Roy C. Johnson
Charles A. Jartberg
JSI, Inc.
Richard M. Karott
Bryan S. Kocher
Josh and Mabel Kopp
Neal Koss
Alan and Judith Kotok
Sieglinde Kress
Stanley Kugell
Robert Larnan
Curtis Laroock
Tsvi Lavi
Grace Leahy
L. Lein & B. Kulpers
John R. Levine
John V. Levy
Joseph L. Levy
Reed Little
Eugene Logemann
E. Lowenstein
Arthur Luehmann
Joseph MacDonald
Julius Marcus
Barry Margolin
Andrew H. Mason
Robert O. Mason
Sibyl Masquelier
J. Stevadson Massey
Robert Mayer, Jr.
Richard McCluskey
F. Warren McFarlan
William McLean
Todd Medlock
Myron Mendelson
Jeanette Middour
Charles Minter
Allen Moulton
J. Craig Mudge
Dorothy Nash-Webber
Isaac R. Nassi
Lee Neal
Tim K. Nguyen
Landon Noll
Bernard J. Nordmann
H. Edward Noyce
James N. O'Boyle, Jr.
Louise O'Donnell
Lawrence & Pauline Oliva
A.M. Oliver
Joseph A. Pallone
Kenneth D. Patterson
Juan Pineda
Michael Pique
John Poppen
James N. Porter
John H. Potter
David Potter
Robert C. Probasco
Brendan Reilly
Audrey Reith
Daniel Rose
David Rose
Thomas S. Roy II
Stephen Russell
Sabaki Corporation
Howard Salwen
Robert Schapp, Jr.
Anne Schwartz
Bennett Schwartz
Andrew Scott
Curtis A. Scott
Sebell Software
Aaron Seidman

R. & M. Shamel
W. Lee Shevel
John J. Shields III
Charles Sholfield
W. Olin Sibert
Dan Siewiorek
Diane J. Skiba
Allen G. Snider
Gerald Steinback
Max J. Steinmann
Hugh W. Stewart
Robert and Diane Stewart
J. Michael Stone
Synergetic Systems
David Tarabor
John Tartar
Paul Tedesco
William R. Thompson
Warren G. Tisdale
Tobin Corporation
Noah E. VanDenburgh
Thomas Vaughn,
Charles Volkstort
Thomas E. Welmers
John D. Wick
Hugh Wilkinson III
James Williams
Kevin Willoughby
Roy Wilson
Richard T. Witek
Frederic G. Withington
Paul Wittman
William A. Wulf
D. L. Wyse

Capital Campaign

64K or more

Apollo Computer, Inc.
C. Gordon Bell
Control Data Corporation
Cullinet
Data General
Gardner Hendrie
Mitchell Kapur
Carver Mead
Kenneth Olsen
John William Poduska
Wang Laboratories

32K or more

American Telephone &
Telegraph
Bank of America
Henry Burkhardt
ComputerLand
Kenneth Fisher
International Data Group
Mitte Corporation
Russell Nofstke
Robert Noyce
Robert M. Metcalfe
Fontaine K. Richardson

16K or more

Anonymous
Clark Baker
Robert P. Berkowitz
The Boston Globe
Howard Cannon
Doug Crane
David K. Dyer
Bruce Edwards
August Klein
Thomas F. Knight
James L. McKinney
NEC Corporation
David & Pat Nelson
Paul & Katherine Severino
Ron Smart
William Spencer
Charles E. Spock
Ivan Sutherland
Min Torna
Chris Terman
Stephen Watson

8K or more

AFIPS
Hiram E. & Lois
Anderson
Erich & Renée Bloch
Winston R. Hindle, Jr.
Index Systems
Theodore & Ruth Johnson
John Allen Jones
Stan Olsen
Russell Plutizer
Doug Ross
Software Results Corp.
Ed Schwartz
Erwin Tomash

4K or more

American Management
Systems, Inc.
Charles & Connie
Bachman
Gene Brewer
Roger and Mary
Cady
R. Steve Chehey
Robert & Eleanor Chunn
Pat Clark
Robert G. Claussen
William Congleton
Alex d'Arbeloff
Arnaud de Vitry
David Donaldson
Robert Everett
Ford Motor Company
Jay W. Forrester
William Foster
General Systems Group
Gaston Snow & Ely
Bartlett
Peter Hirschberg
Houghton Mifflin
Company
International Computer
Ltd.
Jeffrey Kalb
Allan Kent
Jack S. Kilby
Andrew C. Knowles III
David J. A. Koogler
Edward and Debbie
Kramer
John W. and Edna W.
Lacey
Liberty Mutual Insurance
Company
Ralph and Linda
Linsakata
Robert Lucky
John Noms Maguire
Richard D. Mallory
Thomas and Marian
Marill
Daniel D. McCracken
Thomas and Elizabeth
McWilliams
Mediatech
Allen Michels
Microsoft
Robert M. Mornill
New York Air
Nolan Norton Company
John L. Payne
Nicholas A. Pettinella
Edward G. Perlans
Robert M. Price
Regis McKenna, Inc.
Ben Robelen
Jean E. Sammel
Grant Saviers
Hal Shea
Alan F. Shugar
Richard L. Siles
Status Computer Corp.
Del Thordike and Steve
Teicher
3Com Corporation
Jean De Valpine
Charles and Angela
Waste
Harvey W. Wiggins, Jr.
William Wolfson



300 Congress Street
Boston, Massachusetts 02210

The Computer Museum Names New Executive Director

The Board of Directors announced the appointment of a new Executive Director, Joseph F. Cashen, 52, one of the seven original founders of Prime Computer, Inc. Chairman J. William Poduska, Sr., formally introduced Cashen at a Board meeting on February 18, 1987. "When we were at Prime together," Poduska commented, "Joe was always a leader. And now as he accepts the responsibility to direct The Computer Museum, an important resource for the whole industry, he again provides a model of service and integrity. We are extraordinarily fortunate to have Joe at the helm."

Formerly an independent consultant to a number of Massachusetts high tech companies, the new director said, "I joined The Computer Museum because I believe in it. The Museum's size and stage of development allows individuals to make contributions that have major impact. I look forward to building on the established base and helping the Museum to grow into a world class institution with a staff of truly dedicated and talented people." Cashen served as Chief Executive Officer of Acorn Computer, Inc., of Woburn, Mass. in 1983. He spent eleven years with Prime, serving as Vice President of Engineering. Previously he was employed in various management positions in the Computer Control Division of Honeywell, Inc.

His appointment highlights an expansion of the Museum's effort to increase the role it plays in educating a wider audience about the technology, applications and impact of computers in today's society. It also marks the beginning of phase two of the Museum's capital campaign. The Museum has raised over three million dollars to date. These funds allowed the Museum to become established downtown. This position must now be firmly secured through the purchase of a half-interest in the building. Campaign Chairman Paul Severino has brought together a talented and diverse team of volunteers, from all corners of the industry, to help raise the three million dollars needed to successfully complete phase two.

Founding President Gwen Bell stated, "I've watched the Museum grow from a lobby to a building; from one person to many; and from static to dynamic exhibits. Many members and supporters have joined along the way. As we enter a new phase of growth, we need further support. There are terrific challenges ahead, in fund raising, membership development, attendance and new exhibits. Please join me in welcoming Joe aboard, and as a loyal supporter, I hope you'll do all you can to help Joe and the Museum meet the important goals ahead."



Executive Director, Joseph F. Cashen

Table of Contents

Memories	2
Stories behind the Devices <i>Gwen Bell</i>	
Entrepreneurism	12
The Past, Present and Future of Computing in the U.S.A. <i>William Norris</i>	
Computer Memories Poster	16
<i>Mark Hunt</i>	
Calendar	17

Memories Poster Directory

1. Read only memory from Honeywell (1970)
2. IBM 1316 Disk Pack (1963)
3. Planar core memory board from DEC (1972)
4. Small Powers-Samas punched card (c. 1950)
5. Block of magnetic core memory from CDC 6600 (1963)
6. Rod cell memory board from Nixdorf 82023 (1969)
7. Williams tube from the Maniac (c. 1950)
8. IBM Plugboard (c. 1930s)
9. Univac 90-column punched card (1951)
10. Fan-fold paper tape (c 1961)
11. Pegboard program tray from Ferranti Argus 200 (c. 1965)
12. "Complete Mathematical Chart" by C.W. Goodchild (c. 1900)
13. Dec-Tape magnetic tape (1964)
14. Read only Rope Memory from Apollo Guidance Computer (1963)
15. 256K Random Access Memory by Hitachi (1985)
16. Core plane from Honeywell 58 (1970)
17. 64K Random access memory 8 chip double layer package by IBM (1978)
18. Short Magneto-Restrictive delay line from Ferranti Pegasus (1956)
19. Selection from the Johnniac (c.1950)

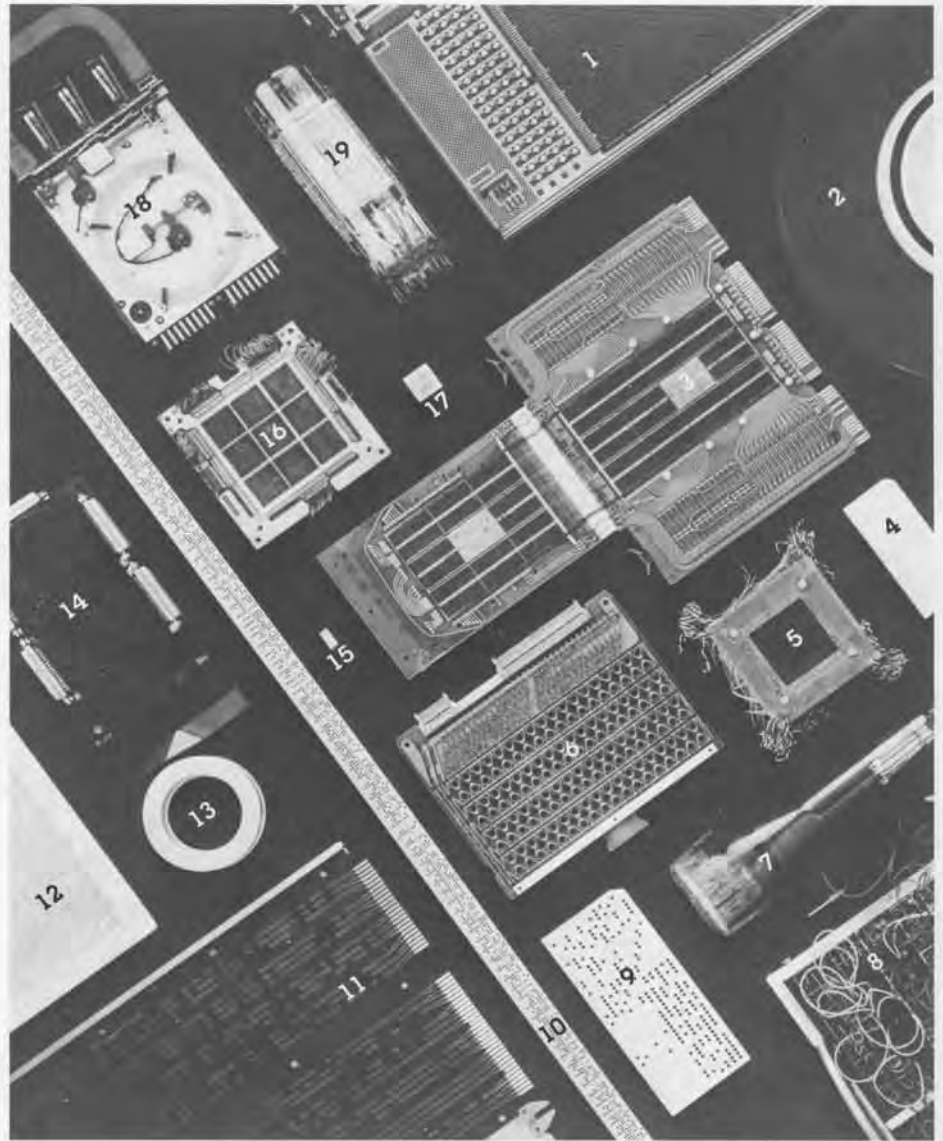

Pre-Computer

Computer

Readable OR Writeable

Linear Access

Badge
Cards
Plot
Printed Page
Punched Cards
Punched Paper Tape

Badge
Cards
Plot
Printed Page
Punched Cards
Punched Paper Tape

Random Access

CRT
Knobs
Patchboard
Switches

CRT
Keys
Knobs
Patchboard
Switches

Memories Chart

The earliest memories appear in the upper left hand quadrant. They have linear access and are readable or writeable by a machine. The latest and most ideal memories are in the lower right hand quadrant: they have random access and are both machine writeable and readable.

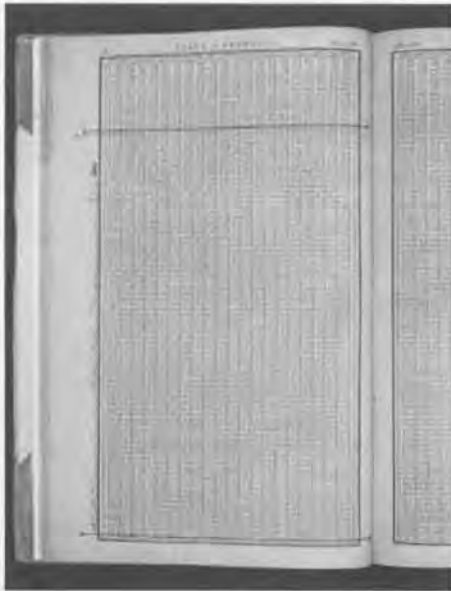

One of the early books, Charles Hutton's, *Table of the Products and Numbers*, 1781, contains the products of the numbers 1 through 1000 by the numbers 1 through 100, and squares and cubes of numbers. This illustration shows all the figures on a line off by 1000. Page from Hutton's - with correction.

29

TABLE OF PRODUCTS.

	301	302	303	304	305	306	307	308	309	310	311	312	313	314	315
1	301	302	303	304	305	306	307	308	309	310	311	312	313	314	315
2	602	604	606	608	610	612	614	616	618	620	622	624	626	628	630
3	903	906	909	912	915	918	921	924	927	930	933	936	939	942	945
4	1204	1208	1212	1216	1220	1224	1228	1232	1236	1240	1244	1248	1252	1256	1260
5	1505	1510	1515	1520	1525	1530	1535	1540	1545	1550	1555	1560	1565	1570	1575
6	1806	1812	1818	1824	1830	1836	1842	1848	1854	1860	1866	1872	1878	1884	1890
7	2107	2114	2121	2128	2135	2142	2149	2156	2163	2170	2177	2184	2191	2198	2205
8	2408	2416	2424	2432	2440	2448	2456	2464	2472	2480	2488	2496	2504	2512	2520
9	2709	2718	2727	2736	2745	2754	2763	2772	2781	2790	2799	2808	2817	2826	2835
10	3010	3020	3030	3040	3050	3060	3070	3080	3090	3100	3110	3120	3130	3140	3150
11	3311	3322	3333	3344	3355	3366	3377	3388	3399	3410	3421	3432	3443	3454	3465
12	3612	3624	3636	3648	3660	3672	3684	3696	3708	3720	3732	3744	3756	3768	3780
13	3913	3926	3939	3952	3965	3978	3991	4004	4017	4030	4043	4056	4069	4082	4095
14	4214	4228	4242	4256	4270	4284	4298	4312	4326	4340	4354	4368	4382	4396	4410
15	4515	4530	4545	4560	4575	4590	4605	4620	4635	4650	4665	4680	4695	4710	4725
16	4816	4832	4848	4864	4880	4896	4912	4928	4944	4960	4976	4992	5008	5024	5040
17	5117	5134	5151	5168	5185	5202	5219	5236	5253	5270	5287	5304	5321	5338	5355
18	5418	5436	5454	5472	5490	5508	5526	5544	5562	5580	5598	5616	5634	5652	5670
19	5719	5738	5757	5776	5795	5814	5833	5852	5871	5890	5909	5928	5947	5966	5985
20	6020	6040	6060	6080	6100	6120	6140	6160	6180	6200	6220	6240	6260	6280	6300
21	6321	6342	6363	6384	6405	6426	6447	6468	6489	6510	6531	6552	6573	6594	6615
22	6626	6648	6670	6692	6714	6736	6758	6780	6802	6824	6846	6868	6890	6912	6934
23	6935	6958	6981	7004	7027	7050	7073	7096	7119	7142	7165	7188	7211	7234	7257
24	7258	7282	7306	7330	7354	7378	7402	7426	7450	7474	7498	7522	7546	7570	7594
25	7618	7643	7668	7693	7718	7743	7768	7793	7818	7843	7868	7893	7918	7943	7968
26	7993	8019	8045	8071	8097	8123	8149	8175	8201	8227	8253	8279	8305	8331	8357
27	8383	8410	8437	8464	8491	8518	8545	8572	8599	8626	8653	8680	8707	8734	8761
28	8788	8816	8844	8872	8900	8928	8956	8984	9012	9040	9068	9096	9124	9152	9180
29	9208	9237	9266	9295	9324	9353	9382	9411	9440	9469	9498	9527	9556	9585	9614

* add 100

by 100

Pre-computer Memories: Read or Write Linear Access

Table Look-up. Napier's Bones, devised at the beginning of the 17th century, were a form of memory for the multiplication tables. Then after John Napier devised logarithms and with the development of calculus, the answers to a series of simple equations were printed and sold widely as books. This phenomena of the book of tables continued through the 1960s. The problem with many of these books was their accuracy. The calculations were done by hand, then the type was set by hand. Sometimes final corrections were made by hand after proofreading.

The Difference Engine was designed by Charles Babbage to accurately produce and print pages of tables of differences. This was later built by Scheutz and produced books of differences. Howard Aiken, whose idea was to produce Babbage's Analytical Engine, desired to produce tables of Bessel Functions of astronomical observations. After the Harvard Mark I had completed these computations, the future use of the computers was questioned

"Complete Mathematical Chart" by Goodchilde, c. 1900 (item 12 in the poster), is two cardboard pages that were available for easy reference. The Museum's collection has a variety of examples of several cardboard pages filled with numbers and very thick books of the thinnest possible paper allowing for as much information as possible. Specialized pocket calculators and computers still maintain frequently used information in lookup tables. General purpose machines perform most calculations rather than relying on lookup tables.

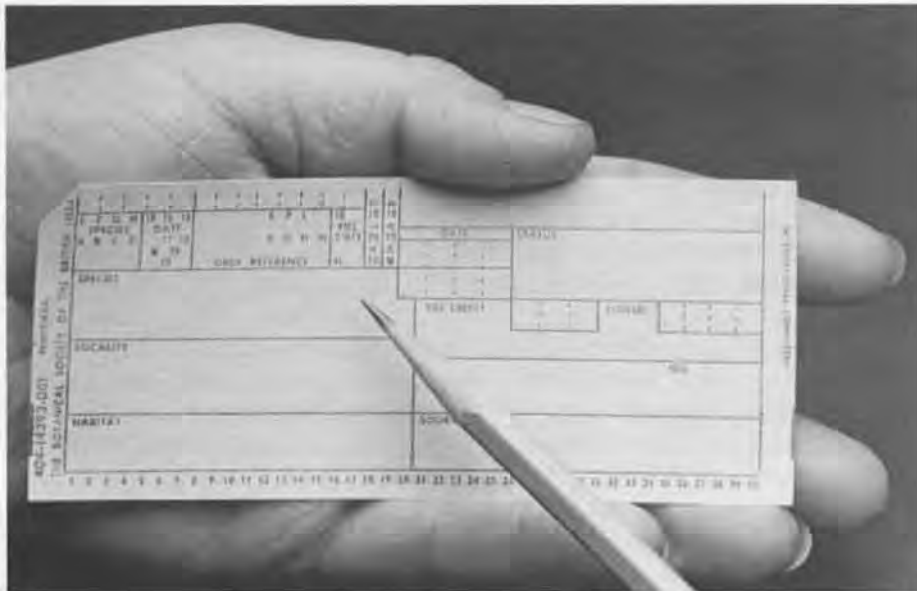

Powers Samas card for recording the distribution of flora and fauna in the British Isles. The map of Abramis was produced directly on a special printer developed for this system.

Punched Cards. In the 1790s, Joseph Jacquard designed a machine to weave silk patterns based on the ideas of Bouchon, deVaucanson and Falcon. This machine used an automatic harness controlled by punched cards connected in a roll that held the pattern. Babbage was inspired by the Jacquard loom and planned to use card input in the Analytic Engine.

Hollerith's punched-card system for the 1890 U.S. Census was the first to use cards for data processing. The size of the Hollerith card was based on the size of the dollar bill at the time, and the round punches were those used by trolley conductors. Hollerith's Computing, Tabulating and Recording Company hired Thomas J. Watson, Sr., as its President, and in 1924 the name was changed to International Business Machines. While the eighty column "IBM" card with rectangular holes became the standard, other sizes and shapes of holes were used for special purposes and niche markets.

The Computer Museum's collection includes a very special punched card system developed by Powers-Samas for the Institute for Terrestrial Ecology in the UK. (Item 4). Field data on the location and species of flora and fauna were written directly on the card to be punched. In the late forties, Professor Maurice Wilkes, who was building the first stored-program computer, consulted on the design and development of a special printer that would take the data from the cards and produce dot maps of distributions in the British Isles.

The 19th century silk looms, where cards were used to create intricate patterns inspired Babbage to use cards to hold other kinds of information.

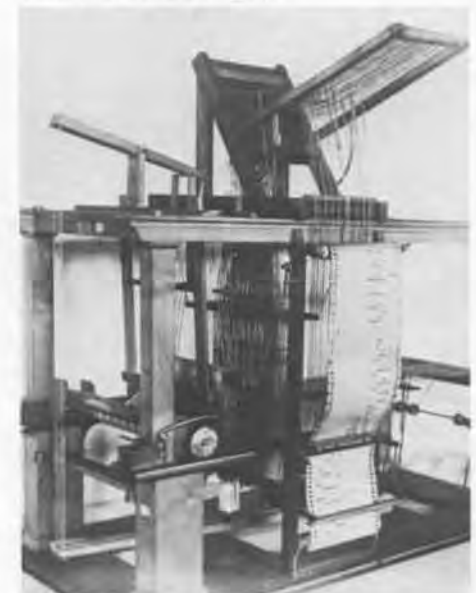



IBM 80 column card with rectangular holes

Computer Memories: Read or Write Linear Access

Punched Cards. Most of the first computers adapted card systems for the input and output of data. The UNIVAC, the first commercial computer, had a 90 column card with round holes (Item 9). Setting one's own standard is often done to get or keep one part of the market. At the outset, when all the competitors are scrambling, the "winner," or de facto standard, is not always obvious. Then, those without standard products often make special compensations to win new customers. The 80 column IBM card became the standard, and UNIVAC came out with the Solid State 80/90. "Solid State" referred to the fact that it had 700 transistors and 3,000 ferractors or magnetic amplifiers and only 20 vacuum tubes. "80/90" meant that it could deal with either the IBM 80 or UNIVAC 90 column cards.

One of the many problems with card storage was their very bulk and lack of density of information. For example, 60,000 cards were required to store the master program for the AN/FS Q7, SAGE system computer built in the late 1950s. They took up 24 cubic feet of space and had to be kept in order. (Later, a reader was developed that could accept cards in any direction or order.) To extend the life of card computing IBM developed System 3 with a smaller card that more than doubled the density of information. This provided no competition, however, for the floppy disk or integrated circuit.

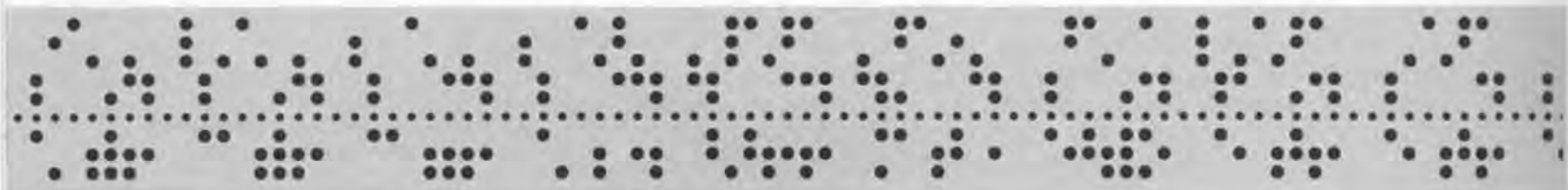

Flexowriters were used to punch the paper tape for the input of data for many of the first computers. These machines and their antecedents were cheaper, stored upper and lower case, and had a better human interface than the punched-card machines. They led directly into the development of computers with keyboard input.

Punched Paper Tape. While the ENIAC used cards for input/output, the EDSAC, the first stored program computer built by Professor Maurice Wilkes at Cambridge University, used punched paper tape (Item 10). This form of input and storage of programs and data, adapted from telegraphy, was quite common on the early university computers. Flexowriters were used to punch tape that could be spliced together with previously punched subroutines. Flexowriters were replaced by Teletype, later Model 33s. Paper tape continued as a form of input up through the beginning of the micro-computer era. For example, Bill Gates delivered the first BASIC interpreter for the 1975 Altair on punched paper tape.

Computer Memories: Read or Write Random Access

Patchboards. The pegboard program tray from the Ferranti Argus 200 (item 11) contained the master program for the machine. Master programs, the precursor of operating systems, were not placed in a read-only memory because the programmers wanted to be able to change them. This meant taking out the tray and replacing the magnetic pegs to make a different set of connections. The early users had even greater difficulty keeping up with the new versions of fundamental operating systems since programmers could come in and change things overnight.

Computer Memories: Machine Readable Random Access

Rope Memory. The design of the early space computers in the late fifties and early sixties preceded the availability of reliable integrated circuits. In 1962, the designers of the Apollo Guidance Computer took a bold step in choosing integrated circuits (invented in 1959) for the logic component of the machine, but they went with more conservative choices for the memory. The computer had 1024 16-bit words of core memory and 24,576 16-bit words of read only fixed memory made of wired-in ropes and cores. R. L. Alonso and J. H. Laming, two of the AGC designers, described these as "compact and reliable devices." The truly important decision was that the astronauts would be able to use a computer that had a 2K erasable memory that they could control.

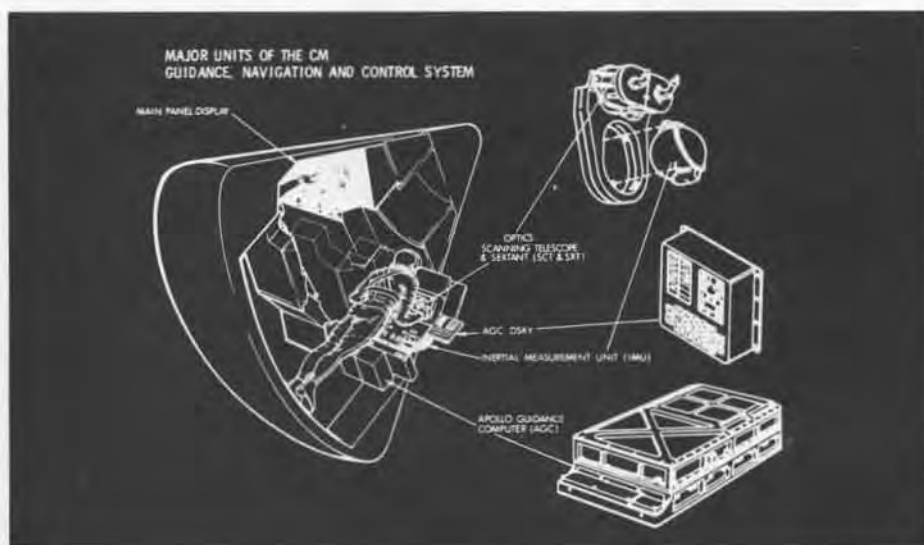
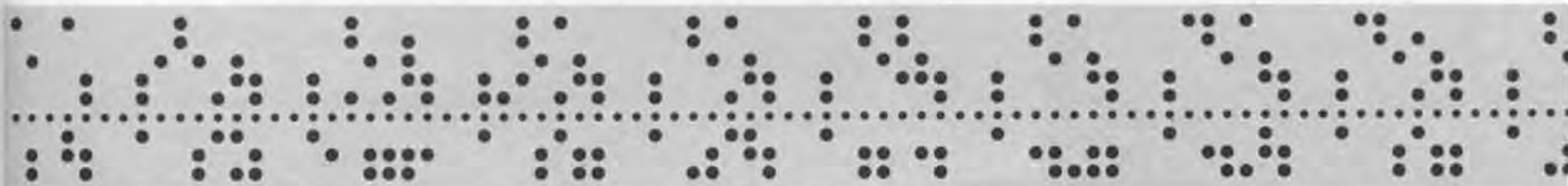
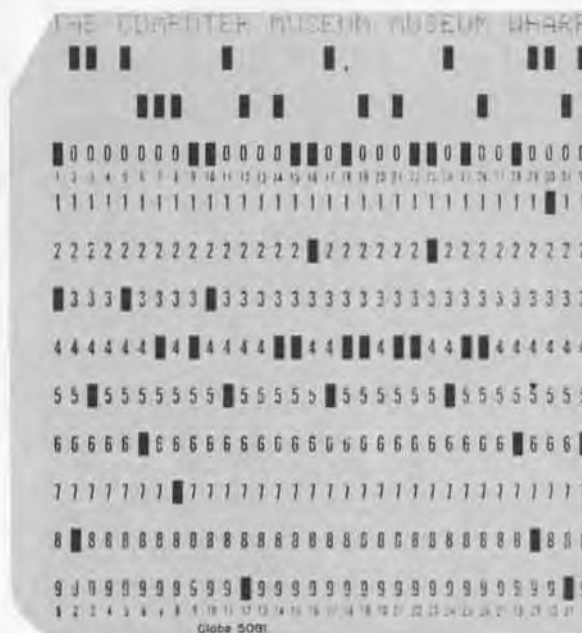

Major units of the CM Guidance, Navigation and Control System from the MIT Draper Lab.



When disks were introduced as a secondary storage device in the late fifties, they had the characteristic of looking like the platter set on a contemporary jukebox. The IBM RAMAC for example had a total of 50 disks.

For a short while, a small Massachusetts company tried to make a market that specialized in weaving rope memories for computers. This technology was used for the character set for Digital Equipment Corporation's 338 display unit available in the mid-sixties.

Computer Memories: Readable and Writeable Cyclical Access

Cyclical memories are still used today primarily as secondary storage in the form of disks and tapes. Prior to the invention of core memory, early computer designers had two choices of primary cyclic memories. Delay lines were reliable but slow and required special talents in logic and programming. The less reliable CRTs were adapted for use as memories by Frederick Williams of Manchester University and called "Williams Tubes."

Delay Lines. Maurice Wilkes, in building the EDSAC, and Alan Turing, in the specifications of the Pilot ACE, chose delay lines. As a result, delay lines were used in English computers throughout the fifties.

The short magneto-restrictive delay line is from Ferranti Pegasus (Item 8). In describing the design philosophy of the Pegasus, its designers W.S. Elliott, C.E. Owen, C.H. Devonald, and B. G. Maudsley, discuss the machine's "rhythm." This rhythm is based on the access to the primary memory of 55 single 42-digit word magneto-restrictive delay lines. A basic 3-beat rhythm was established. Beat 1 of one-word time extracts two orders from the memory; beat 2 of two-word times obeys the first order; beat 3 of two-word times obeys the second order. (Clearly a waltz with a first quickstep.) Programmers of delay-line machines learned to optimize the rhythm and were heard to regret the simplicity of programming for all the later machines based on random-access primary memories.



The LGP-30 was one of the many small scale drum computers sold in the fifties. Built in 1956, in 1962 it rented for \$1300 a month. The drum on the far right held 4K bits of information.

Drums and Disks. Magnetic drums were the earliest form of secondary magnetic storage. Prototype magnetic drum computers included the Harvard Mark III and the ERA 1101. The magnetic drum provided a large amount of slow memory at relatively low cost. Typical drum-storage systems are 8-20 inches in diameter and revolve at 1,500-4,000 rpm. There were literally dozens of magnetic drum computers of varying capacity that were the small to medium-sized computers of the first generation.

In the late fifties, the IBM 305 RAMAC (random access method of accounting and control) was among the first -- if not the first -- data processing system to employ a magnetic disk file permitting direct random accessing of records. The system, with 50 disks, stored 20 million characters.

Computer Memories: Machine Readable Linear Access

Magnetic tape. Magnetic tape has had the advantage of being a relatively stable product, with specifications for its physical or magnetic properties changing very little. Archival tapes from two decades ago are generally still readable. In contrast, disk technology has rapidly changed.

The "DEC-tape" (Item 13) is a non-standard tape that can be thought of as an important component of mini-computers and a precursor to the floppy disk. The small tape units were designed by Wesley Clark for the LINC computer. Two dozen LINCs (Laboratory Instrument Computers) were built by their users at MIT in 1962. The LINC-tape was small, removable and portable. Users could carry their own around, the same way that users today treat their system and data disks. DEC reverse-engineered the tape and used it on its own LINC-8 system and then on the PDP-12.

An original hand built Linc is on the left in use in a laboratory. Several years later DEC sold the Linc as a product.



The Williams tube was used as a graphic device. Each instruction was read in twice on the same line. If it agreed then a check mark appeared on the second half of the line. Below is a detail of the screen.

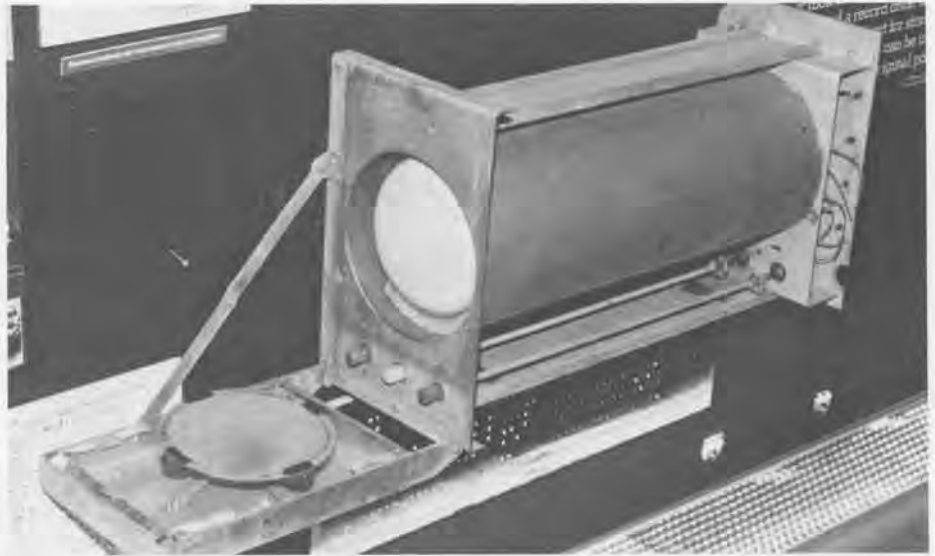
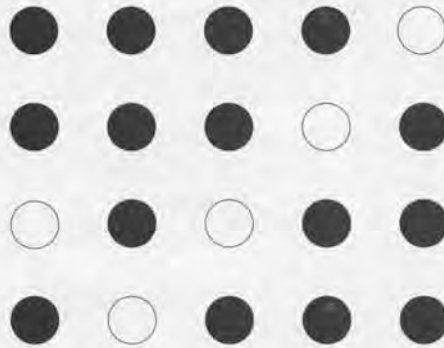
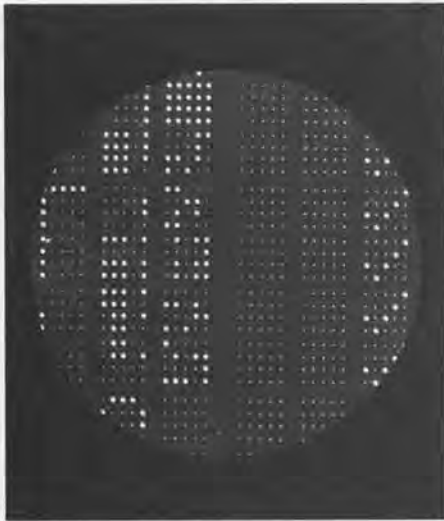

Computer Memories: Machine Readable Random Access

Williams Tubes (Item 7). Professor F. C. Williams of Manchester University developed the first random access computer memory. Julian Bigelow, who was building a computer at Princeton's Institute for Advanced Studies with von Neumann, recalls Williams and his lab: "My visit to Manchester was a delightful experience; F.C. Williams was a true example of the British 'string and sealing wax' inventive genius, who had built a primitive electronic computer out of surplus World War II radar parts strictly on his own inspiration — in the middle of which were two cathode-ray tubes storing digits — the "Williams' memory." I can remember him explaining it to me, when there was a flash and a puff of smoke and everything went dead, but Williams was unperturbed, turned off the power, and with a handy soldering iron, replaced a few dangling wires and resistors so that everything was working again in a few minutes. ...The whole technique depends upon clever exploitation of the fortuitous secondary electron emission properties of cathode-ray-tube phosphor screens — phosphors that are chosen and incorporated purely to give good visual response without regard for secondary electron emission. In this sense it was a lucky accident that the scheme worked at all." (Julian Bigelow, "Computer Development at the Institute for Advanced Study," in *A History of Computing in the Twentieth Century*, N. Metropolis et al., 1980.)

Despite all of this seeming "black magic" around the Williams tube, it was successfully used by IBM on their 701 series of computers.

Short Chronology of Major Events in the Development of Core Memory Abstracted from Emerson W. Pugh, *Memories that Shaped an Industry*, MIT Press, 1984.

1946	1947	1948	1949	1950
1/46 Jay Forrester proposes a computer at MIT			6/49 Forrester begins documentation in his notebook of a memory using magnetic materials 9/49 An Wang describes a shift register using magnetic toroids of Deltamax	8/50 M.K. Haynes thesis describes his coincident-current magnetic core memory proposal. 9/50 Jan Rajchman of RCA files a patent application for a coincident-current magnetic memory. 10/50 Forrester initiates ferrite material work at MIT

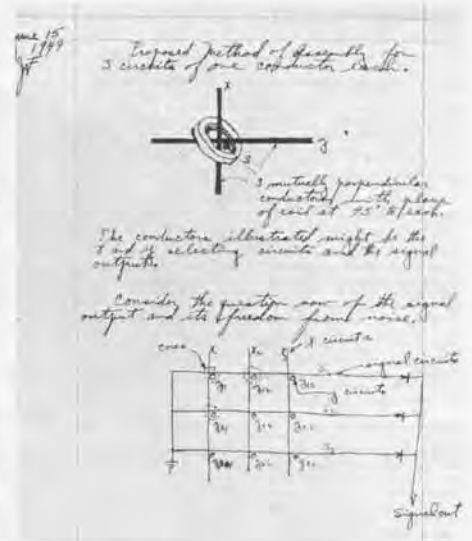
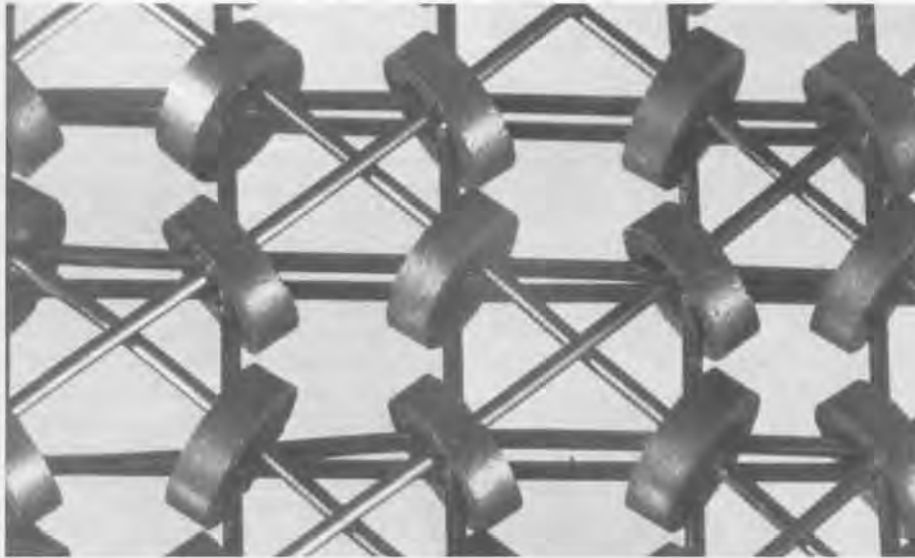

Core Memory. Both the IAS machine and MIT's Whirlwind made do with a version of the Williams tube as their original memory devices. But in both cases, the concept of using some sort of magnetic random access device was under consideration.

The original diagram shows only the coordinate wires for the core. The diagonal wires on the manufactured core plane provide the read element for each core.

The IAS group was working with Jan Rajchman of RCA to develop a fast parallel memory to operate the arithmetic unit. After two years of development no wholly operative memory had been produced. Julian Bigelow remembers, "von Neumann and I made an attempt to list all the variables which would have to be kept under control to produce a 50% yield of successful Selectron tubes covering a range of digital capacities from the original goal of 4096 digits per tube, down through 2048, 1024, 512 etc. In any event, although the Selectron tube held out intellectual respect and admiration, we had increasing doubts that it would provide something we could use in the near future." Several years after the IAS Computer was running, a 256 digit Selectron tube was delivered to the Rand Group for the Johnniac (Item 19).

About seven years passed between the beginning of the invention of core memories for computers and their delivery to customers within a commercial product. Over the next twenty years, until the late seventies, core memories were the predominant form of primary memory. After 1971, when IBM shipped their first system with all-semiconductor main memory, engineers tried to pack greater and greater density to compete with these new products. The 1972 planar core memory board from DEC (item 3) achieved two bits of information from each core by reading the memory at two different voltages. Core is still used in a few systems to gain the reliability that comes from a stable memory regardless of power failure.

1951	1952	1953	1954	1955	1956
5/51 Forrester files for a patent on his magnetic core memory	1/52 2x2x2 ferrite core memory built in Hayne's group at IBM	5/53 First ferrite core main memory operates on MIT Memory Test Computer with a 32x32x17 array			1/56 IBM ships 702, 704, and 705 computers with ferrite core memories.
12/51 Successful operation of a 16x16 array of metallic cores at MIT	5/52 4x4x4 ferrite core memory operates at IBM				

Entrepreneurism:

The Past, Present and Future of Computing in the USA

William Norris,
Chairman Emeritus
Control Data Corporation

The genesis of Electronics Research Associates (ERA), one of the first computer companies, was the U.S. Navy's World War II Communications Supplementary Activity in Washington (CSAW). Often referred to as "Seesaw" because of its initials, its primary mission was to intercept and decode enemy messages. The mission was of such critical importance that no expense was spared to assemble the best talent and develop the technology needed to assure maximum success.

Toward the end of the War, Dr. Howard Engstrom and I, both members of CSAW, put a plan together to preserve the unity and continuity of the efforts and the team. We suggested that a significant number of the team would form a private company that would make their services available to the Navy under contract. The new company would, at the same time, develop other business based primarily on electronic digital circuit technology. Late in 1944, the Navy accepted our proposal and all we needed was financing.

Venture capital hadn't yet been invented and information about the nature of our expertise was highly classified. About all that we could say was that we had a group of talented professionals with unique expertise in the design of electronic digital circuits that had potential for new products in a number of important fields.

Seventeen companies and a number of individuals in the Washington/New York area were contacted. We visited J. Prespert Eckert and suggested that we undertake a joint activity. Eckert said that the plans for his company had pretty well jelled and that he didn't want to consider that possibility. Later, fate destined us to get together when Eckert-Mauchly became a division of Remington Rand in 1950, as did ERA in 1952.

Admiral Lewis Strauss, Assistant to Navy Secretary Forrestal, was one of the partners of the Wall Street firm of Kuhn, Loeb who were identified as a source of financing. Since security was not a constraint in talking to

Admiral Strauss, he was greatly intrigued by the concept and said that he would finance the company personally even if his partners in Kuhn, Loeb were not interested. Before signing, Admiral Strauss asked that a member of his staff, Commander Paget, review the proposal. Admiral Strauss pointed out that Commander Paget was planning to establish a consulting company that he was personally financing. Paget concluded that while our plan was interesting, it wasn't economically viable. Both Strauss and Kuhn, Loeb backed out.

The final chapter of this incident was written 25 years later when Control Data acquired the Commercial Credit Company, and the firm of Cresap, McCormick and Paget was one of the consultants proposing to help. When their proposal was presented, the introduction contained a message from Mr. Paget expressing the hope that with the passage of time I had forgiven him for his erroneous conclusion. Indeed, 30 years and the success of Control Data, especially the latter, had mellowed my resentment.

Yet in 1945, Admiral Strauss's rejection was a devastating blow because we were led to believe that we had located our sorely needed financing after a long and arduous hunt. Even worse, by then the war had ended and time was running out.

Then, late in 1945, we learned that Northwestern Aeronautical, a company located in St. Paul, Minnesota, that was a war-time contractor for troop-carrying gliders, was looking for a new direction. After several meetings with the President, John Parker, a deal was struck, and ERA had a home in St. Paul.

Incorporated in January 1946, ERA's equity ownership was divided equally between the founder group and the financial group headed by Mr. Parker. 100,000 shares of stock were sold



William C. Norris seated at the console of a 3600 Computer in 1964.

to each group to provide \$20,000 total equity. In addition, Parker's group guaranteed a line of bank credit of \$200,000.

Superb human capital and effective government contracting methods helped us to meet the requirements of CSAW. The R&D work for this agency was performed under cost plus fixed fee contracts. This was advantageous and effective because it allowed wide flexibility in setting initial specifications and altering them to gain maximum performance. Such contracts came both from the Bureau of Ships and the Office of Naval Research. This type of contract was a new and enlightened approach by the Navy. In combination with entrepreneurial enterprise, not only were the needs of the Navy met, but many important advances were made in computer technology. In the process of performing a large number of R&D contracts, ERA built up a vast reservoir of technology, evidenced by the large number of spin-off companies that were spawned.

ERA built the first commercially available digital computers, the 1101 and 1103, and also developed and manufactured magnetic storage devices. By 1952, ERA's growth was outstripping its limited capital base, and the only alternative for maintaining growth was to merge with a large company. I stayed on as general manager of the ERA Division of Remington Rand. When Remington Rand merged with Sperry to form Sperry Rand, I became general manager of the Univac Division, where all computer activities were consolidated.

Although Sperry Rand had acquired the industry's two leading entrepreneurial computer companies with a major part of the leading edge technology in the industry, namely Eckert-Mauchly and ERA, they were unable to capitalize on the technology lead. I resigned to form Control Data.



Control Data's first day on the New York Stock Exchange, March 6, 1963.



The shipment of the First 1604 computer to the U.S. Navy.

Control Data Corporation

In July 1957, CDC was incorporated based on an initial financing by the sale of 615,000 shares of stock to the public for \$1.00 per share. Control Data was the first publicly financed new computer company. Part of the ERA team came with me and we focused on a line of engineering and scientific computers that included supercomputers at the top.

My definition of a supercomputer is "today's most powerful, general purpose, computer." That definition implies that there can be only one supercomputer at any one time. Since any computer's power varies for different applications, this means that there may be two or three machines that deserve to be called supercomputers at any one time. Thus, in their day, the ENIAC, EDVAC, ERA 1103, CDC 6600, CDC 7600, CRAY 1, and CDC Cyber 205 could all be legitimately called supercomputers. In the early seventies, CDC also

initiated the Plato computer-based education system in cooperation with the University of Illinois and the National Science Foundation, because computer-based education is the most significant application area. High quality relevant courseware consisting of more than 15,000 hours on material in a broad range of 150 subject areas is currently available.

Education and Competitiveness

Computer based education not only delivers and manages instruction, it also provides the capability for reducing or eliminating the time consuming administrative tasks associated with teaching, thereby making more efficient use of instructional resources. This allows teachers to spend more time with students and gives students more time for improving their skills. Unfortunately, utilization of computer-based education has not kept pace with the growing availability of high quality courseware and decreasing costs of

hardware and software. The adverse consequences of this lag are especially serious in the K-12 educational spectrum where the basic underpinnings of a skilled work force are formed.

The decline in the ability of our work force to handle comprehensive notions of science and technology translates into an important factor in declining U.S. competitiveness in world markets. Ample evidence is available to show that the Japanese school system far exceeds ours in its ability to prepare educated workers for business and industry. For example, youngsters in Japan spend more time developing their ability to handle science, math and foreign language than in the USA.

Knowledge is becoming an increasingly important factor in the work force. Unless education and training is significantly improved, our technically illiterate work force will place us at an even greater competitive disadvantage. Considering all the constraints, the only practical solution is a massive increase in the use of computer-based education.

Environment for Entrepreneurship

Despite the critically important role entrepreneurship has played in the computer industry and indeed in our entire national economy, the environment for small enterprise innovation is deteriorating along with our competitive position in world markets. Most markets suffer from unprecedented domination by multinational corporations, many of them foreign-based, to the disadvantage of medium and small companies with limited resources, especially for manufacturing.

The passage of the Mansfield amendment to the military procurement authorization act of 1970 required that research be related to weapon systems. This act significantly reduced access

to technology by small companies and gave large military systems contractors more control over research.

Small companies receive less than three percent of total government R&D funds. Given the record of small enterprise as a major source of innovation, this resource is far from being utilized. The small business innovation research program passed by Congress about 1982 has only helped modestly.

Fortunately, venture capital, a major stimulus to small enterprise innovation, continues to be in plentiful supply. Unfortunately, the innovations are made in the pre-venture capital stage, where government R&D can greatly help. Seed capital is required to advance technology from the research and idea stage to the point where venture capital commitments can be made.

Broadly speaking, our foreign competitors, especially Japan, have greatly accelerated research and development, dramatically increased the number of trained scientific and technical personnel, reduced needless and wasteful duplication of technology development, fostered growth and lowered the cost of capital in carefully targeted industries. The Japanese government has promoted cooperation among industry members at the base technology level as a key ingredient for success.

The declining US competitiveness is largely related to inefficient and, at times, inept management of technology. Public/private cooperation is needed to substantially increase the efficiency of research, development and manufacturing. Three new institutions provide models: The Microelectronics and Computer Technology Corporation; A Job Creation Network; and The Midwest Technology Development Institute.

The Microelectronics and Computer Technology Corporation (MCC)

The MCC was established in 1982 in Austin, Texas. It has grown from eleven to twenty-one participating companies from the US computer and semiconductor industries. Base technologies are developed by MCC's scientific and engineering talent and provided to the members. Member corporations can each add their own value and continue to compete with products relating to their own freely selected markets. MCC also licenses technologies on reasonable terms to others, including small companies.

A ten-to-one leverage is gained by the member companies in MCC. If every industry had a similar cooperative arrangement, it would provide a much-needed boost to innovation and competitiveness.

The Microelectronics and Computer Technology Corporation (MCC) Corporate Membership List.

Advanced Micro Devices, Inc.
Sunnyvale, CA
Bell Communications Research, Inc.
Livingston, NJ
Digital Equipment Corp.
Maynard, MA
Harris Corp.
Melbourne, FL
Honeywell Inc.
Minneapolis, MN
NCR Corp.
Dayton, OH
Westinghouse Electric Corp.
Pittsburgh, PA
Allied-Signal Inc.*
Morristown, NJ
Boeing Co.
Seattle, WA
Control Data Corp.
Minneapolis, MI
Eastman Kodak Co.
Rochester, NY
General Electric Co.
Fairfield, Conn.
Lockheed Corp (Lockheed Space and Missile Co.)*
Sunnyvale, CA
Martin Marietta Corp.
Bethesda, MD
3M Co.
St. Paul, MN
Motorola Inc.
Schaumburg, Ill.
National Semiconductor Corp.
Santa Clara, CA
Rockwell International Corp.
Pittsburgh, PA
Unisys Corp.*
Detroit, MI
Hewlett-Packard Co.
Palo Alto, CA

*Companies that have announced they are leaving MCC at the end of 1987

Job Creation Network

The Job Creation Network operates at the community level to improve initiatives for expanding innovation. It consists of three elements.

- 1) A cooperation office is a non-profit organization that helps a new company shape a business plan, obtain financing, or locate a base technology. The staff is bolstered by a volunteer advisory panel of experts.
- 2) A seed capital fund is accumulated from a consortium of state and local government and private investors with tax credits made available.
- 3) A business and technology center provides consulting services, shared laboratory, manufacturing, office or other services to facilitate the startup.

Aggressive programs have been established in Illinois, South Carolina, Minnesota and Canada.

The Midwest Technology Development Institute (MTDI)

The MTDI was established in 1985 with nine member states. MTDI has the threefold objective of:

- 1) expanding technological cooperation among midwest universities and industry to increase the efficiency of research and the commercialization of the results;
- 2) extending technological cooperation to include universities in foreign countries;
- 3) providing a mechanism to increase the availability of technology to industry, especially small businesses and

to achieve an equitable transfer of technology between the US and foreign countries.

Unbalanced Technology Flow

A partial list of reasons for the inequitable technology flow that goes from the US to Japan includes:

- * A significant part of Japan's basic research is carried out in government laboratories that are closed to foreigners.
- * US companies cannot participate in Japanese government-funded R&D projects that have explicit commercial objectives, nor, for the most part, do US companies have access to Japanese patents.
- * Small US companies are a major source of technology for Japan that is obtained by licensing or acquisition. US enterprise does not have a similar opportunity.
- * Japan has virtually unlimited access to US research.
- * The best Japanese graduate students come to the US and are supported both intellectually and financially and do not repay this capital investment.
- * The US has not diligently pursued the acquisition of Japanese technology.

One of the first corrective actions was taken in 1986 with the amendment of the Stevenson-Wydler Innovation Act that gave the directors of the US federal laboratories discretionary authority to deny access to research to any foreign country that does not grant similar privileges to American organizations.

Implementing equitable technology flow agreements with

other countries will require that the US keep track of technology transfer. MTDI is playing a major role in establishing a measurement system that will include mechanisms for inventorying and tracking technology. They will also institute a large scale program aimed at helping transfer Japanese technologies to small US companies.

Technology Momentum

The flourishing of entrepreneurial enterprise during the decade between 1945 and 1955 provided the momentum that accelerated through the early 70s to put the US into world leadership in the computer industry. A great deal of credit must be given to the Navy, especially the Office of Naval Research Program in Computing for the stimulation and support of the development of computer technology until it was ready for commercialization. This early support coupled with entrepreneurship was a major factor in helping to build the momentum that propelled the United States into world dominance of the computer industry. Indeed, leadership in computer technology was also a catalyst to innovation in other fields and until recently, the US has been dominant in technological innovation in the world.

The position has been deteriorating in the last decade. Unless corrective action is undertaken with massive technological cooperation and with an environment for entrepreneurial enterprise, the erosion will continue. If the corrections are made then entrepreneurial enterprise will again realize its potential and play a leading role in expanding innovation on the scale necessary for assuring the well-being of the country.

Computer Memories Poster

Mark Hunt

You may have seen the image on the cover of this issue of the *Report* in advertisements in leading computer publications over the past few months. The story of how this public service campaign developed is worth telling because it illustrates how enormously the Museum benefits from collaborative efforts.

In the spring of 1985 Gabe d'Anunzio, vice-president of marketing programs for MICOM-Interlan, suggested to the Museum staff a public service announcement campaign advertising a poster picturing "antique" computer memories.

Gabe put the Museum in touch with Grafik Communications, of Arlington, Virginia. They volunteered to design the poster and the advertisement, and to arrange for free photography and production of the posters in exchange for limited in-kind services for their client, VM Software. VM Software photographed the Museum's exhibits and items from the collection for their annual report.

The key elements still missing were commitments from the publishers to run the ads at no cost and a color separation for each publication.

Our first calls were to David Bunnell, publisher of *MacWorld* and *PC World*, and Harry Brown, publisher of *Byte*. They agreed to run the ads if we provided color separations. Paul Thiel, vice-president of marketing communications at Scitex America Corp., maker of state-of-the-art computer-controlled color separating equipment, then agreed to supply color separations and we were in business.

Almost every publisher we spoke with was eager to participate. Each offered a full-page, full-color advertisement. The total advertising space committed is valued at almost \$225,000, with a combined circulation of 3.4 million high-tech readers of 25 publications. The total value of the program is almost a quarter million dollars. All from the hard work of many dedicated friends and staff of the Museum.

Responses to the advertisement are streaming in daily. Readers send a tax-deductible contribution of \$25 or more to receive the elegant full-color poster. To order your own poster, check the appropriate box on the membership coupon on page 17, and return it to the Museum with your own \$25 tax-deductible contribution.

Participating Publications

AI Expert
Boston ComputerNews
Byte
Circuits Manufacturing
Computer
Computer Design
Computer Graphics World
ComputerWorld
Data (Denmark)
Datamation
DEC Professional
Digital Design
Digital News
Digital Review
Electronics Test
Hardcopy
High Technology
Information Center
InformationWEEK
InfoWorld

People that Made it Happen

Gabe d'Anunzio
MICOM-Interlan
Gwen Bell
The Computer Museum
Alex Berry
Grafik Communications Ltd.
Mark Hunt
The Computer Museum
Judy Kirpich
Grafik Communications Ltd.
Megan McCarthy
Scitex America Corp.
Renate Brown Neely
VM Software
Gail Rosen
Scitex America Corp.
David Sharpe
David Sharpe Studio
Oliver Strimpel
The Computer Museum
Rich Theis
Scitex America Corp.
Paul Thiel
Scitex America Corp.
David Variable
Scitex America Corp.

Companies that Donated Services

David Sharpe Studio
Grafik Communications Ltd.
Scitex America Corp.
Type Studio
Virginia Lithograph

Calendar Spring 1987

- May 3**
Sunday
4 pm **Dick Shoup, Aurora Systems.**
"A Perspective on Digital Videographics or, How Computer Graphics Can Brighten Up The Evening News".
Learn about the process and equipment that won Shoup an Emmy for his pioneering work in computer graphics.
- May 17**
Sunday
4 pm **Jean Louis Gassée, Vice President of Product Development, Apple Computer, Inc.**
"The Future of Personal Computers".
Gassée will share his predictions about what lies ahead in the fast-paced and ever changing world of personal computing.
- May 30**
Saturday
2 pm **Bruce Schwoegler, WBZ-TV Meteorologist.**
"Computers and the Weather".
Learn how computers are used to gather weather to television viewers.

Coming Events

- June 18**
Thursday **Opening of SMART MACHINES, a major new gallery on robots and artificial intelligence.**
Visitors will see and interact with the history and current state-of-the-art of intelligent machinery. The gallery will feature over 20 hands-on demonstrations, a unique collection of historic robots, and entertaining film. The working exhibits will include programs with expert knowledge of areas of medicine, geography and art. Others will try to answer questions posed in plain English. There will be working industrial, teaching and toy robots. Members will receive invitations to an exhibit opening and preview.
- June 19**
Friday
7:30 pm **Herman Budnick, Herman Budnick & Associates.**
"Development and Implementation of Videodisk/Videotex Information Systems".
Learn about the state-of-the-art distributed videotex approach used to create a system of public tourism information kiosks for Boston's Logan International Airport.
- May 9**
Saturday
7pm **The Computer Museum's 5th Birthday Party!**
A fun-filled evening of live and silent auctions with entertainment by clowns, magicians and jugglers!

- YES!** I want to become a Member of The Computer Museum.
- YES!** Please refresh my memories by sending my *Memories Poster*. A tax-deductible contribution of \$25. or more is enclosed.
- \$20 Student** **\$ 45 Family** **\$250 Sponsor**
 \$30 Individual **\$100 Donor** **\$500 Patron**

Members receive free admission for one full year, invitations to exhibit previews, advance notice of exhibitions and lectures, invitations to members-only events, a subscription to our exciting quarterly magazine, *The Computer Museum Report*, and a 10% discount in the Museum Store. Members who send a contribution of \$25. or more are entitled to receive the elegant full color *Memories Poster*. Check the box above if you want to receive the poster.

Enclosed is my check, made payable to **The Computer Museum** for \$ _____

or charge to: VISA MasterCard American Express

Card # _____ Expiration Date _____

Signature _____

Name _____

Address _____

City _____ State _____ Zip _____

Contributions are tax-deductible to the extent provided by the law.
The Computer Museum, 300 Congress Street, Boston, MA 02210

The Computer Museum

The Computer Museum is a non-profit 501(c)3 foundation that chronicles the evolution of information processing through exhibitions, archives, publications, research and programs.

Museum Hours: *Summer:* Open daily 10 - 6, Friday 10 - 9. *Winter:* Open Tuesday - Sunday 10 - 6, Friday 10 - 9. Open Mondays during Boston school vacation weeks, 10 - 6. Closed Thanksgiving, Christmas, and New Years Day. Hours are subject to change.

Membership All members receive a membership card, free subscription to the *Computer Museum Report*, a 10% discount on merchandise from the *Computer Museum Store*, free admission and invitations to Museum previews. For more information contact Membership Coordinator at the *Computer Museum, 300 Congress Street, Boston, MA 02210.* Telephone (617) 426-2800.

Staff

Joseph F. Cashen, *Executive Director*

Dr. Gwen Bell, *Founding President*

Lynn Hall, *Registrar*

Tom Merrill, *Exhibits Technician*

Dr. Oliver Strimpel, *Curator*

Michael Bergman, *Exhibit Specialist*

Dr. Leah Hutten, *Exhibits Developer*

Marc LeBlanc, *Exhibits Intern*

Bonnie Turrentine, *Education Director*

Megan Hayes, *Education Specialist*

Kurt Levitan, *Education Assistant*

Gregory Schroeder, *Operations/Visitor Coordinator*

Mark Hunt, *Marketing Director*

Patricia Fiorelli, *Public Relations Manager*

Laura Goodman, *Store Manager*

Ani Benglian, *Assistant Store Manager*

Linda Holekamp, *Communications Assistant*

Kathleen Keough, *Functions Coordinator*

Michael N. Oleksiw II, *Development Director*

Jennifer Fields, *Benefits Coordinator*

Scott Reilly, *Development Assistant*

Susan Versailles, *Membership Coordinator*

Matt Murray, *Interim Business Manager*

Vannette Bastien, *Accountant*

Yvette Molina, *Assistant Accountant*

Lisa Moorehead, *Office Coordinator*

Germain DRK,

Public Relations Advisors

Jackson-Blum-Shapiro,

Advertising Consultants

Michael Sand, Inc.,

Exhibit Planning Consultants

Kevin Burke, David Shopper, Martha

Everson, *Photography*

The End Bit 0000000000000001

This 1984 experimental memory chip by IBM holds 288K bits on a single integrated circuit. It is part of the History of Computing slide sets, available along with the Personal Computer slide set from The Computer Museum Store.

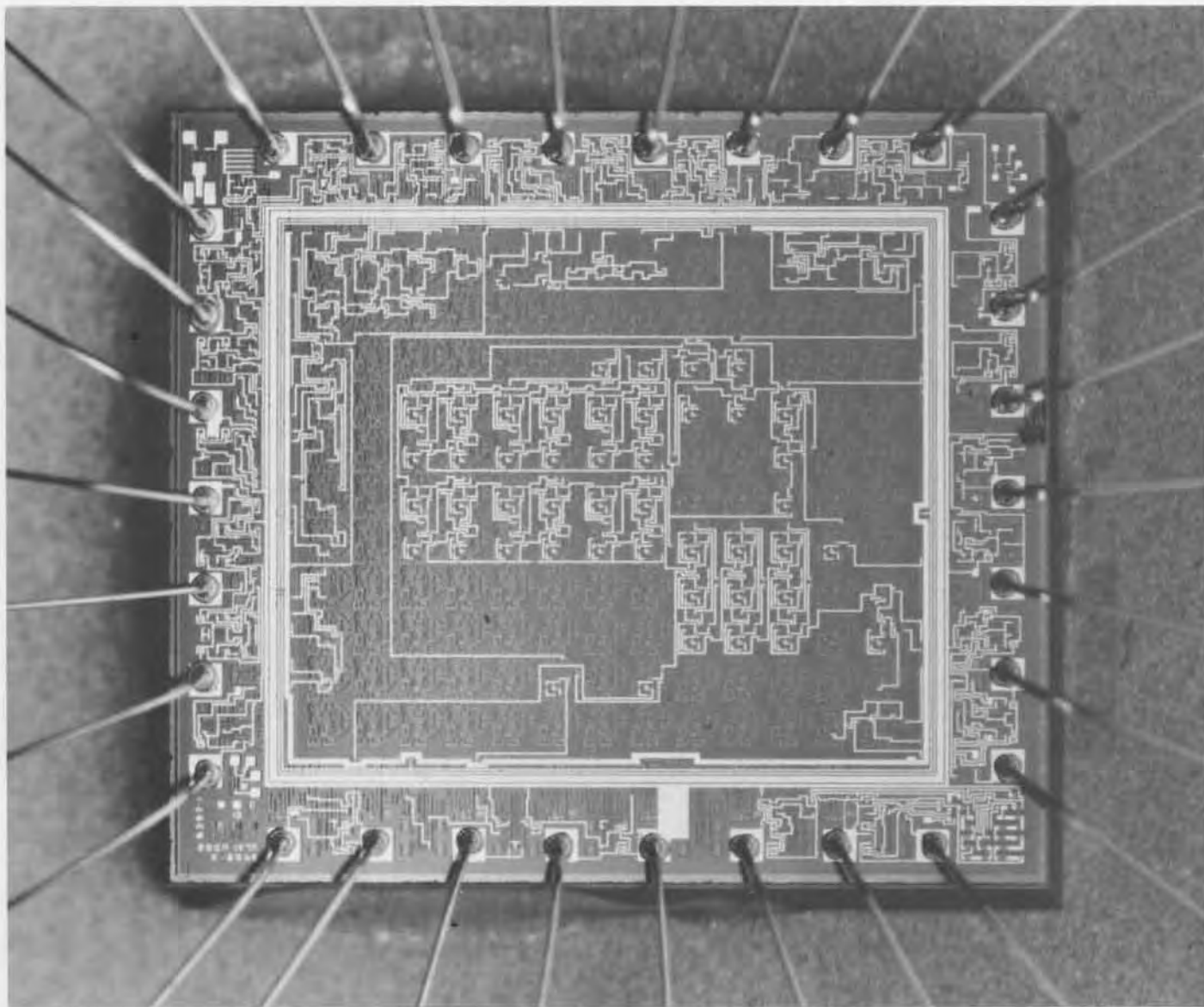

The Computer Museum
300 Congress Street
Boston, Massachusetts 02210

Non-Profit
Organization
U.S. Postage
PAID
Permit No. 110
Fitchburg, MA
01420

Address Correction Requested

THE COMPUTER MUSEUM REPORT

VOLUME 20

SUMMER/FALL 1987

A black and white photograph of a mechanical hand, possibly a prosthetic or a specialized tool, holding a rectangular sign. The hand is constructed from various metal parts, including a cylindrical base and several fingers. The sign is tilted and contains the text "SMART MACHINES" in a bold, sans-serif font. The background is dark and indistinct.

**SMART
MACHINES**

Board of Directors

John William Poduska, Jr.
Chairman
Stellar Computer, Inc.
Joseph F. Cashen
Executive Director
The Computer Museum
Gwen Bell
Founding President
The Computer Museum
Erich Bloch
National Science
Foundation
Lynnda Schubert Bodman
Schubert Associates
David I. Chapman
Cullinet Software, Inc.
David Donaldson
Ropes and Gray
John J. Evans
Manufacturers Hanover
Trust
Sydney Fernbach
Computer Consultant
William Foster
Status Computer
Thomas Gerrity
Index Systems, Inc.
Gardner Henrich
The Sierra Partners
Max D. Hopper
American Airlines
Arthur Humphreys
ICL
Mitchell Kapur
Lotus Development Corp.
August Klein
MASSCOMP
Koji Kobayashi
NEC Corp.
Robert Lucky
A/T Bell Laboratories
J. Carl Moss
International Data Group
James L. McKenney
Harvard Business School
Carver Mead
California Institute of
Technology
Robert M. Metcalfe
3Com Corp.
Arthur P. Molesha
The National Museum of
American History
Smithsonian Institution
Laura Banker Morse
Russell Reynolds
Associates
David Nelson
Apollo Computer, Inc.
Russell Nottsker
Symbolics, Inc.
Nicholas Pettinella
Intermetrics, Inc.
Jonathan Rotenberg
The Boston Computer
Society
Jean E. Sammet
International Business
Machines Corp.
Edward A. Schwartz
Digital Equipment Corp.
Naomi Seilgman
The Research Board
Paul Severino
Wellfleet Communica-
tions, Inc.
Hai Shear
Pell Rudman & Co., Inc.
Irwin J. Sittin
Aetna Life Insurance Co.
Ron Smart
Digital Equipment Corp.
W. J. Spencer
Xerox Corp.
An Wang
Wang Laboratories, Inc.

Trustees

Charles Bachman
C. Gordon Bell
Harvey D. Crogon
Robert Everett
C. Lester Hogan
Theodore G. Johnson
Andrew Knowles III
John Lacey
Patrick McGovern
George Michael
William Millard
Robert Noyce
Brian Randell
Kitty Selridge
Michael Spock
Erwin Tomash
Paul Terras
Maureen Wilkes

Executive Committee

David Donaldson,
Chairman
Joseph F. Cashen
Gardner Henrich
James McKenney
Nicholas Pettinella
John William Poduska, Jr.
Jonathan Rotenberg
Edward Schwartz
Ronald Smart
Paul Severino

OPERATING GRANTS — CORPORATE MEMBERSHIP

Sustainer — \$10,000 or more
Digital Equipment Corp.
Hewlett-Packard, Co.
International Business
Machines Corp.
Institute of Museum
Services
Massachusetts Council for
the Arts and
Humanities

Benefactor — \$10,000
Aetna Life Insurance Co.
American Express
Foundation
Raytheon Company
Sanders Associates
Tandy/Radio Shack Corp.
Xerox Corporation

Patron — \$3,000
Amdahl Corporation
Bitstream
Boris Color Labs, Inc.
Burnoughs Corporation
Coopers & Lybrand
DECUS
Dentsu, Inc.
Draper Laboratories
Gaston Snow & Ely
Bartlett
Gourmet Caterers, Inc.
Honeywell
IEEE Computer Society
Lotus
Manufacturers Hanover
MASSCOMP
McGraw-Hill, Inc.
Prime Computer Corp.
Ropes & Gray
Sun Microsystems
Symbolics, Inc.
The Travelers

Contributor — \$1,000
Adage, Inc.
Adelle Corp.
Analog Devices, Inc.
Analogic Corporation
Apple Computer
Arthur Andersen, Inc.
Arthur D. Little, Inc.
Bank of Boston
Bank of New England
BASF
Baybanks
Bolt Beranek & Newman
Boston Consulting Group
Boston Safe Deposit
Cancom Systems
Cognition, Inc.
Dane Fabo Stone & Co.
Data Architects, Inc.
Data Translation
Deloitte Haskins & Sells
Eastech Management
E.M.C. Corporation
Executours, Inc.
Festive Foods Caterers
Foley Hoag & Eliot
Gatlik Communications
Ltd.
Goldman, Sachs & Co.
Greylock
GTE Laboratories, Inc.
Hyams Trust
Index Technology
Innova
Intel Corporation
Interpage Group
MachVision, Inc.
Mentor Graphics
MICOM Interlan, Inc.
Microcom
Micro Control Systems
NEC Corporation
NYNEX Service Company
Palmer & Dodge
Peat, Marwick, Mitchell
Pell Rudman & Co., Inc.
Price Waterhouse
Russell Reynolds
Associates
Shawmut Corporation
Sotex America
Sequent Computer
Systems, Inc.
Standard Oil
Sterling Hager
Telectronics
Tordayne
Testa, Hurwitz & Thibault
VM Software
Wagner & Stackpole
XRE Corporation

Contributing Members

Donor — \$500 or more

Nick De Wolf
Phil Dorn
Roy Duncan
Tom Eggers
Don L. Esner
Alan E. Frisbie
Branko Gerovac
Tom and Rosemarie Hall
M. Ernest Huber
Robert Kahn
Martin Kirkpatrick
Raymond Kurzweil
Andrew Lawrie
Christopher Morgan
Linda J. Phillips
Paul R. Pierce
Ann Roe-Hofer
Jonathan Rotenberg
O. & K. Sellridge
Thomas F. Stephenson
Seth Stern
William Stuel
Leo Yochum

Sponsor — \$250

Isaac Auerbach
Jordan Baruch
Graham Beachum
G. C. Beiden, Jr.
James Bell
Gordon S. Brown
Richard J. Clayton
Richard Corbett
David N. Cutler
Donald R. Deryn
James B. Decker
Delta Management
Lucian J. Endicott
Bob O. Evans
Lary Forte
Kevin and Judith Galvin
Branko Gerovac
John Gilmore
Roberto Guastella
W. Richard Johnson
Lawrence J. Kalgallen
Bob King
Marlan Kowalski
Sheldon Lavde
Eli Lipson
Carl Machover
Joe W. Matthews
Tron McConnell
Steven Nevins
Joseph M. Newcomer
Anthony Oettinger
James V. Patton
James A. Pitts
J. Eric Pollack
James N. Porter
Audrey Reith
C.M. Riggle
Linda & David Rodgers
Thomas S. Roy II
Michael J. Sarnak
John J. Shields III
Charles A. Stott
John V. Tenney
Michael Tomasic
G. Michael Uhler
Christian Walker
Alan L. Wallock
Andrew Wilson

Friend — \$100

Kenneth R. Adcock
R.J. Alexander
Timothy Anderson
Roland Arndt
Professor Arvind
Robert Z. Bachrach
Richard G. Bahr
Steve Bane
Dawn R. Banks
Robert M. Barokus
Mario Barozca
Steve F. Barnaby
John C. Barstow
Alfred M. Bertocchi
Lois J. Bizak
Bontronics
Carol Botteron
Daniel S. Bricklin
Robert E. Brney
Fred & Nancy Brooks
D. F. Brown
John and Ann Brown
Lawrence Brown
Les Brown
Erk Bruhn
Gerald A. Bujacius
Roger M. Buoy
W. Carlson
Mario L. Carr
George Chamberlain
George Champine
M.H. Caden
James F. Cody
Howard I. Cohen
Michael J. Coppolino
Howard E. Cox, Jr.
Ronald Creamer
Michael Cronin
Daniel Crowley
CSDP
James Cudmore
Paul Curran
Randall Davis
Joseph Dearborn
Harvey Deitel
F. Demeo
Kevin W. Dick
Lucien Dumino

DiFaragran Family
Patrick M. Donini
Kathleen Dorson
Theodora Drapos
Dik Dunnington
R. DuVal
Esther Dyson
Joseph J. Eachus
Richard J. Eckhouse and
Ruth Maulucci
William T. Elliott
Margaret Ellis
Thelma Estrin
P. J. Evans
Andrew Fahey
Andrew Feit
Geoffrey Feldman and
Sharon Lopp
Harold Fitch
Philip Fox
Robert France & Ruth
Doan
J. Thomas Franklin
Clair Frazier
Daniel Freedman
Bruce Gee
Bruce Galchrist
David Goodman
Edward Gordon
Roger Gould
Roger H. Goun
William Graustein
Stephen Gross
Paul C. Guglietta
Jerrie A. Haradad
J. Scott Hamilton
Keith W. Hare
James S. Harvison
Frank E. Heart
Daniel and Nancy Heit
Paulyn Heimiller
Ted Hess
Thomas L. Hohmann
M. Hoppet
S. Hors
J. Ingham
Ifferbase Software Corp.
Roy C. Johnson
Charles A. Jortberg
JSL, Inc.
Richard M. Karoff
John Kemony
Bryan S. Kocher
Josh and Mabel Kopp
Mark Koretz
Neal Koss
Alan and Judith Kotak
Ralph Krans
Sieglinde Kress
Stanley Kugell
Robert Laman
Curtis Larock
Tsv. Lavi
Grace Leahy
Margaret L. Leibyl
L. Lein & B. Kuipers
John R. Levine
John V. Levy
Joseph L. Levy
John D.C. Little
Reed Little
George Logimarin
Carl D. Lowenstein
Arthur Luehmman
David E. Lundstrom
Joseph MacDonald
Julius Marcus
Barry Margolin
Andrew H. Mason
Meivan J. Mason
Richard O. Mason
Robert O. Mason
Sivyl Masquerier
J. Stevardson Massey
Peter Masters
Robert Mayer, Jr.
Richard McCluskey
F. Warren McFarlan
Douglas McKenna
William McLean
Todd Medlock
James Meehan
Myrtle Mendelson
Margaret Midkour
Charles Minner
Allen Moulton
J. Craig Mudge
Rayman Mustafa
Dorothy Nash-Webber
Isaac R. Nass
Lee Neal
Tim K. Nguyen
Landon Noll
Bernard J. Nordmann
H. Edward Nyce
Thomas F. Oberst
James N. O'Boyle, Jr.
Louise O'Donnell
Martin O'Donnell
Lawrence & Pauline Oliva
A.M. Oliver
Leon M. Pardell
Joseph A. Pallone
Kenneth D. Patterson
George Peo
James H. Philip
Juan Pineda
Michael Pogue
Michael Cox
John Poppen
James N. Porter
John H. Porter
David Potter
Richard Powell
John F. Pries
Robert C. Probasco
Brendan Reilly
William S. Reilly
Audrey Reith
Daniel Rose
David Rose

Thomas S. Roy II
Stephen Russell
Sabaki Corporation
Howard Schwien
Michael Sarnak
Robert Sarty
Robert Schapp, Jr.
Phillip H. Schenker
Anne Schwartz
Bennett Schwartz
Andrew Scott
Curtis A. Scott
Ronald F. Shea
Sebell Software
Acron Seidman
J. A. Seaxner
R. & M. Sharnel
W. Lee Shelvel
Charles Sheffield
W. Olin Sibert
Dan Siewiorek
Diane J. Skaba
Phil Slaughter
Allen G. Snider
Gerard Steinback
Max J. Steinmann
Bruce G. Stewart
Hugh W. Stewart
Robert and Diane Stewart
J. Michael Stone
Paul Sullivan
Steve Swerling
Synergetic Systems
David Taraba
John Tartar
Paul Tedesco
Thomas Thackrey
Michael Thompson
William R. Thompson
Warren G. Tisdale
Michael Tomasic
H. Dean Toombs
Nicola E. VanDenburgh
Thomas Vaughn
Charles Volkstort
Christian Walker
Thomas E. Welmers
John D. Wick
Hugh Wilkenson III
James Williams
Kevin Willoughby
Roy Wilson
Richard T. Witek
Frederic G. Withington
Paul Wittman
William A. Wulf
D. L. Wyse
Hermann Zatz

Capital Campaign

64K or more

Apollo Computer, Inc.
C. Gordon Bell
Control Data Corporation
Cullinet
Data General
Gardner Hendrie
Mitchell Kaper
Carver Mead
Kenneth Olsen
John William Poduska
Wang Laboratories

32K or more

American Telephone &
Telegraph
Bank of America
Henry Burkhardt
ComputerLand
Kenneth Fisher
International Data Group
Buge Jamieson
Mitre Corporation
Russell Nottsker
Robert Noyce
Robert M. Metcalfe
Fontaine K. Richardson

16K or more

American Management
Systems
Anonymous
Clark Baker
The Boston Globe
Howard Cannon
David Donaldson
Doug Drame

David K. Dyer
Bruce Edwards
Index Systems
August Jean
Thomas Knight
James L. McKenney
NEC Corporation
David & Pat Nelson
Paul & Katherine Sevettino
Ron Smart
William Spencer
Charles E. Spork
Ivan Sutherland
System One
Chris Terman
Anson Totta
Stephen Watson
Daniel Weinreb

8K or more

AFIPS
Harlan E. & Lois Anderson
Erch & Renee Bloch
Winston R. Hinde, Jr.
Theodore & Ruth Johnson
John Allen Jones
Stan Olsen
Russell Rantzer
Dana Ross
Edward Schwartz
Software Results Corp.
Erwin Tomash

4K or more

Charles & Connie
Bachman
Gene Brewer
Roger and Mary Cady
R. Steve Chehey
Robert & Eleanor Chinn
Pat Clark
Robert G. Clausen
William Congleton
Alex d'Arbeloff
Arnold de Vitry
Robert Everett
Ford Motor Company
Jay W. Forester
William Foster
General Systems Group
Gaston Snow & Ely
Bartlett
Peter Hershberg
Houghton Mifflin
Company
ICL
Jeffrey Kalib
Alan Kent
Jack S. Kilby
Andrew C. Knowles III
David J. A. Kogler
Edward and Debbie
Kramer
John W. and Edna W.
Looney
Liberty Mutual Insurance
Company
Ralph and Linda
Linsalata
Robert Lucky
John Norris Maguire
Richard D. Mallory
Thomas and Marian
Manil
Daniel D. McCracken
Thomas and Elizabeth
McWilliams
Mediatech
Allen Michels
Microsoft
Robert M. Morrill
New York Air, Inc.
Nolan Norton Company
John L. Payne
Nicholas A. Pettinella
Edward G. Perkins
Robert M. Pitter
Regis McKenna, Inc.
Ben Rubelton
Jean E. Sammet
Grant Savers
Sequent Computer
Systems Corp.
MGI Sheet
Alan F. Shugart
Richard L. Siles
Stratus Computer Corp.
Del. Thordike and Steve
Teicher
3Com Corporation
Jean De Valpine
Charles P. Wate
Harvey W. Wiggins, Jr.
William Wolfson

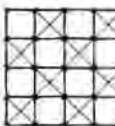
 **The Computer Museum
Museum Wharf
300 Congress Street
Boston, MA 02210**

The Making of the Smart Machines Exhibit

Oliver Strimpel

On June 18, 1987, The Computer Museum opened a 4000 square foot exhibit entitled *Smart Machines*. It is the largest single exhibit the Museum has undertaken in its five year history.

Birth

The idea of a Computer Museum exhibit on artificial intelligence (A.I.) and robotics goes back to January 1985. The Museum had just re-opened in its downtown Boston site. The initial set of exhibits consisted of four galleries that were primarily historical and one gallery that dealt with a particular aspect of current technology: computer imagery. The public's positive response to the Image Gallery encouraged us to plan another thematic exhibit. After meetings with several sub-groups of the Museum's Board of Directors and other interested people, the combination of artificial intelligence and robotics rose to the top of the list.

Why combine A.I. and robots? When deciding what should be included in the exhibit, we followed a definition of A.I. that was formulated by Marvin Minsky. In doing so, we opted in favor of exhibiting machines that performed tasks that, if carried out by humans, would have required some intelligence. Thus, our exhibit demonstrates the idea that A.I. encompasses the mental aspects of solving a problem or fulfilling a task while robots perform the physical motions required to carry out that task.

Of course, a major research goal is to merge A.I. and robotics, creating an intelligent autonomous agent. Shakey, one of our prize robots, epitomizes this effort. It was driven by A.I. - the problem-solving program STRIPS - but was itself a robot, complete with drive mechanisms and a range of sensors.



Photo: Dan McCoy/Skanow

In addition, an exhibit on A.I. and robotics serves both of the key aspects of the Museum's mission - education and preservation - while offering a unique and entertaining experience for the visitor. The educational challenge was to demonstrate and explain a rapidly evolving subject. Furthermore, we were anxious to preserve many one-of-a-kind robots that were neglected and in danger of being lost. Within the span of a few months we assembled the world's most comprehensive collection of research robots. Finally, we aimed to make the exhibit popular by selecting entertaining interactive A.I. programs, including several on music, art and games, and by exploiting the innately appealing nature of robots.

Taking Off

The exhibit went through a lengthy gestation period - from January 1985 to June 1986.

Oliver Strimpel and Leah Hutten hanging a drawing by Harold Cohen's program AARON.

Gwen Bell and I gradually built up support and interest, locating exhibit ideas, programs and artifacts, and putting some flesh on the conceptual skeleton.

In the summer of 1986, the founders of Symbolics, Inc., met

Table of Contents

The Making of the Smart Machines Exhibit

Oliver Strimpel..... 1

Smart Machines - A Survey of the Exhibit

Oliver Strimpel..... 4

Historical Timeline of Artificial Intelligence and Robotics

Gwen Bell and Leah Hutten 12

at the Museum to hear a presentation given by Gwen Bell and me on the new project. They subsequently announced their intention to fund the exhibit. Gordon Bell, Museum Trustee and Associate Director for Computing and Information Science at The National Science Foundation, also made a major gift towards the exhibit. By September the project's funding was secure and a nine month countdown to the opening began.

The first task was to build up the exhibit team. Leah Hutten joined the Museum as exhibit developer for the robot section, while I concentrated primarily on the A.I. exhibits. Michael Bergman came aboard as our technical coordinator to manage the wide assortment of computers and working robots that would power the exhibits. Gwen Bell agreed to develop the historical timeline of A.I. and robots and to help catalyze the exhibit's development. Marc Leblanc, a high school student intern, became the team's resident hacker. Meanwhile, Tom Merrill readied the Museum workshop in preparation for actual construction of the exhibit.

We hired the office of Michael Sand, Inc., to design the exhibit. They transformed our ideas into a floorplan and a physical display system and also provided ideas for making the exhibit more inviting. WITCOM Associates was hired to create seven video programs from 24 different sources selected from over 70 original tapes that we had collected. The video program for the Smart Machines Theater was a particularly complex job because of the need to relate the video to the artifacts on display. DEC provided their studio for final editing where we created a master tape that was used to make a videodisk containing the video for the entire gallery. Michael Callahan was engaged to provide the audiovisual and

electronic systems, Steve Cummings came on board to compose sound tracks, and Ripman Lighting Consultants took on the lighting and special effects for the Theater.

Formulating the Exhibit

The topics to be covered by the exhibit fell into six sections spanning A.I. and robotics and are described later in this Report.



Tom Merrill adjusting the "Frankenstein Set," based on a Maxell advertisement.

Since we believe that the core elements in our educational exhibits on computing are the engaging working displays, we put most of our effort into developing non-static exhibits. We were extremely fortunate in finding a very skilled group of volunteers to help script and program unique and dynamic exhibits for us. Joe Bates, on his way to a faculty position at Carnegie-Mellon University, offered to help us create an exhibit that would address the problem of knowledge representation in A.I. After discussing many fascinating but unworkable ideas, we came up with the plan to base a demonstration on a conversation with the intelligent computer HAL in the movie *2001: A Space Odyssey*. Joe wrote the script, and Marc LeBlanc programmed it onto an interactive videodisk system provided by DEC. Another successful match was made by Randy Davis of the MIT A.I.

Laboratory who brought us together with Mitchel Resnick and Franklyn Turbak. Their goal was to find a way to build a rule-based expert system that would demonstrate in an entertaining way the strengths and weaknesses of rule-based techniques. They designed Haymarket, a trio of rule-based storekeepers, each of which has its own strategy for making innocent customers pay far too much money for a box of strawberries.

Still other volunteer help was provided by several of Michael Bergman's programmer friends: Tom Courtney programmed the object recognition demonstration, Sterling Barrett helped with the natural language interface demonstration and Steve Kukulich tailored a demonstration of how computers play games for Museum use. In addition, Bob Lee ruggedized the game West for us while Steve Foster, Warren Adam and Brian Sandberg, students from the Wentworth Institute, examined our historic robots and restored every possible degree of freedom. Finally, Curt Crittendon and Grinnell More built and programmed a sensing mobile robot.

To support the many working displays we planned, we sought the participation of numerous computer companies. We received full support from almost every company we approached. The matching of applications with available hardware proceeded step-by-step as each gift of equipment was confirmed. The 70 companies and 12 universities who contributed are listed on page 11.

Lastly, we put a great deal of effort and exhibit technology into the Smart Machines Theater with 25 historic robots on display. Each artifact comes to life on video with additional sound, light and motion effects that create an entertaining and instructive show.

The Final Push

The construction of the exhibit took place in the Museum's own workshop. Initially consisting of Tom Merrill and Joslin Fields, the workshop staff expanded in the final few weeks to include museum interpreters Wauter Habraken and George Kfoury and several other staff members. Indeed, almost every member of the Museum staff and Michael Sand's office joined in the construction effort. Several groups worked right through the night in preparation for the opening. Alan Symonds (Ripman Lighting), officially in charge of the exhibit's lighting, also installed the robots from the Maxell advertisement in between the cuing of the lighting and sound effects for the Theater. Together with his team from the American Repertory Theater, Alan lent his able hand to almost every aspect of fabrication. Many of the alchemical props used for the fantastic Frankenstein Set were provided by Boston University's chemistry department and Al Rifkin, the "mad scientist" owner of Able, the robot. Among the Museum staff, Michael Oleksiw, Linda Holekamp, Mark Hunt, Kathy Keough, Kurt Levitan, Greg Schroeder and Bonnie Turrentine volunteered many late hours assembling panels, painting, and helping in innumerable ways. Lynn Hall became the site manager, channelling all the available manpower into maximum productivity. Gwen Bell extended the number of available man-hours by providing abundant Chinese food every evening. Gordon Bell pioneered a new system for assembling the exhibit panels and installed the air conditioner in the machine room. Andre and Judith LeBlanc, Roger Glovsky, Patti Hillis, and Laura and Victor Gregg also joined in.

The gallery was threaded with an Ethernet local area network, connecting up the MicroVAXs,



Photo: Don McCoy / StrataWare

Twenty-five historic robots in the Smart Machines Theater.

Suns, Hewlett-Packard Bobcats and the Sequent computers. With so many new machines being installed and the extension of the network, we called our friends at the MIT Media Lab for help. Their resident system wizard, Henry Holtzman, obliged and in the final 48 hours up to the opening overcame seemingly insurmountable hurdles to make all the computers work in harmony.

In parallel with the concentrated effort in the gallery, our programmer friends were distributed around the building, busily adding the finishing touches: Tom Courtney (vision), Sterling Barrett (natural language front-end), Bob Lee (West), Steve Kukulich (tic-tac-toe), Jim Meehan (TALE-SPIN), Jonathan Press (grammar-checker), Mitchel Resnick and Franklyn Turbak (Haymarket), Harold Cohen (AARON), and the students from the University of Lowell (boat-builder and log-cabin builder). Marc Raibert successfully coaxed a PDP-11/40E into life to drive his one-legged hopper, Henry Holtzman, attempting to get FranzLISP (needed to run our version of ELIZA) running on the Sequent computer in the small hours of the morning, came to a standstill because of an incompatible tape format. In desperation, we called up Thinking Machines hoping someone would be around. Sure enough,

Steve Strassman was there and invited Henry over to fix the problem.

To the outside eye, the days before the opening were a scene of hopeless chaos. But to those involved in the project, there was a great sense of purpose and team spirit. Hidden skills emerged among staff, contractors and volunteers, and many friendships were established.

Barely one hour before the ribbon-cutting, Shigeo Hirose's long-awaited quadruped and snake-like Oblix arrived from Tokyo. In a final burst of activity, the crate was torn open, and these unique objects took their allotted positions in the robot theater. The sounds of the vacuum cleaners had barely retreated at the far end of the gallery as the opening speeches ended, and the ribbon was cut. Six hundred contributors and museum members swarmed into the gallery. About 400,000 lines of application code, running under 4 types of LISP, C, Basic, and Pascal, 50 robots weighing 6 tons, 25 computers, and 7 video programs came to life.

Smart Machines was open!

Smart Machines

Oliver Strimpel

The unifying theme of the Smart Machines gallery is to demonstrate how machines do things that have hitherto been the province of intelligent human activity. We were determined to convey to our visitors the tremendous sophistication of the human mind and body, as well as some of the difficulties scientists face in their attempts to replicate even the simplest of human activities. The combination of A.I. and robotics was straightforward enough: we wanted to demonstrate both the mental capabilities and the physical dexterity of today's machines. This article attempts to explain how the various live exhibits selected for Smart Machines exemplify past and present trends in A.I. and robotics.

The exhibit is grouped into six sections: language understanding, knowledge-based systems, game-playing, robot sensing, mobile robots and robot arms. The historical time-line and robot theater are described in the next article.

Language Understanding

One of the major conclusions of A.I. research during the 1970s was that knowledge and language could not be clearly separated. The early attempts to understand or translate language on a word-by-word basis failed. However, research has continued along several lines, and progress has resulted in commercially successful products.

A grammar correction system from Houghton-Mifflin shows how much a computer can do without any knowledge of the meanings of words. Visitors can watch the grammar checker find mistakes and correct them automatically.

Unlike a grammar checker, parsing is just the first stage of a program that actually tries to understand the meaning of a sentence. In a natural language interface program, the knowledge resides in the database. However, the questions stated in English must be translated into a machine language query to the database. Our exhibit features Datatalker, a natural language interface from Natural Language,

Inc. It asks visitors to type in information about themselves, which it stores. It then invites questions in plain English about previous visitors. The program's task is eased because it expects a question about something in its database. After parsing a visitor's question stated in English, the program tries to extract the sentence's meaning, and, if appropriate, converts it into instructions to search through its database for information that will answer the question. The result of the search is translated back into an English reply. Other parts of the program keep track of the dialog, deciding when responses are adequate.

To go beyond a simple question and answer conversation, computers need a much wider and deeper knowledge. The exhibit addresses this enormous problem by demonstrating some of complexities of building a real computer like HAL in the film *2001: A Space Odyssey*.



From Dan McCoy, Rainey

Grammar correction system. To correct a sentence such as "The student at the school beyond the bridges go home at noon," the program must parse the entire sentence and realize that neither the bridges nor the school is going home, but the student.

Using an interactive video disk system, visitors can analyze a short conversation between HAL and Dave, the astronaut. A speech synthesizer explains what HAL must know to recognize Dave's speech, how HAL might use scripts and form plans and goals. The exhibit aims to convince visitors that building a machine comparable to a person is a huge challenge, but one that is amenable to scientific research.

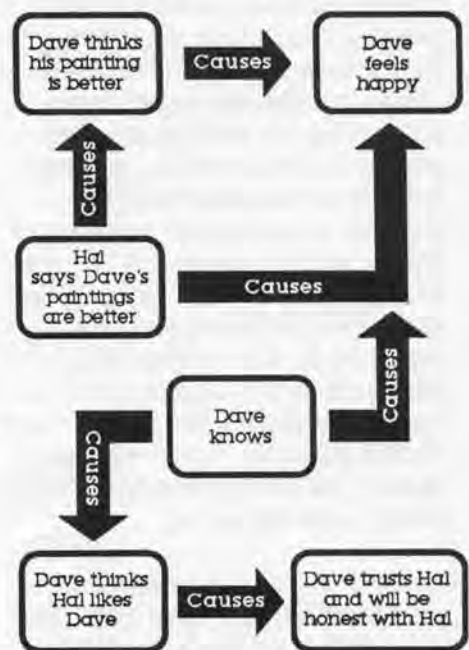



Photo: Dan McCoy/Rainbow

Haymarket - where visitors haggle with a computer. During the interaction, a tracer shows the rate at which rules are checked, and marks those whose IF parts are true, causing the THEN part to fire. The storekeepers' thoughts and speeches are spoken out loud by a speech synthesizer.

Two exhibits are conversational programs that pretend to know more than they do. ELIZA, the classic computer psychotherapist program written by Joseph Weizenbaum in 1966, takes key words from the visitor's typed-in text and uses them to trigger stock questions. It also repeats the user's words, turning statements into questions. ELIZA exploits its role as a non-directive therapist to justify its extreme passivity. In contrast, RACTER converses volubly with the visitor on many arcane topics. Like ELIZA, it has no model of the world, but responds to key words in the input text by concocting sentences based on standard forms. It attempts to skirt around its lack of understanding by making a virtue out of being zany. These programs are not presented as A.I., but as illustrations of the limitations of approaches that use words without knowledge.

Haymarket Rules for Noah Budge

IF: the stage-of-game is greetings	IF: the input-type is number
SAY: "Welcome to my store. Just \$6.00 for this box of strawberries."	AND: the customer-offer is-equal-to \$6.00
CONCLUDE: the stage-of-game is bargaining	THINK: "This is a reasonable customer."
■	SAY: "You've got a deal!"
IF: the stage-of-game is-not greetings	CONCLUDE: the stage-of-game is finished
CONCLUDE: the number-of-interactions is-increased-by 1	■
■	IF: the input-type is number
IF: the number-of-interactions is-greater-than 4	AND: the customer-offer is-greater-than \$6.00
AND: the input-type is-not number	THINK: one-of "This customer is a sucker."
OR: the customer-offer is-less-than \$6.00	"This customer has money to burn."
CONCLUDE: the stage-of-game is finished	SAY: "You've got a deal! Come back again!"
THINK: one-of "That's the last straw. This bargaining is going nowhere."	CONCLUDE: the stage-of-game is finished
"This clown has tried my patience for too long."	■
SAY: one-of "You're wasting my time. Get out of my store and stay out!"	IF: the input-type is complaint
"I don't need troublemakers like you. Leave my store now!"	AND: the stage-of-game is-not finished
■	THINK: one-of "Why do I get stuck with all the complainers!"
IF: the input-type is number	"All I ever hear are complaints."
AND: the customer-offer is-less-than \$6.00	"Looks like I have a complainer of my hands."
AND: the stage-of-game is-not finished	SAY: one-of "Come on. I have other customers waiting. Make me an offer."
THINK: one-of "Is this customer hard of hearing?"	"Quit your complaining and make me an offer."
"This person's a bozo!"	■
"Another customer trying to take advantage of me."	IF: the input-type is compliment
SAY: one-of "No, I told you my price is \$6.00."	AND: the stage-of-game is-not finished
"You don't hear too well. I said \$6.00."	THINK: one-of "This customer's trying to butter me up. That won't work."
"Look, I'm busy. \$6.00 is my price. Take it or leave it."	"I'm sick of customers trying to sweet-talk me."
	SAY: one-of "Enough flattery. Make me an offer."
	"I'd rather have \$6.00 than your compliments."

The eight rules that drive Noah Budge, a simple-minded storekeeper.

Knowledge-Based Systems

The greatest number of useful applications in the field of A.I. have emerged from rule-based expert systems. Several hundred expert systems perform tasks ranging from diagnosing failures on gas turbines to suggesting which pesticides to use on a particular crop. In general, a Museum should exhibit genuine examples of its subject matter.

However, expert systems are tools aimed at the technical user and would be totally incomprehensible to the majority of our visitors. As a compromise, we included one "real" expert system, somewhat modified for the Museum by its author, Randy Miller. The system is Quick Medical Reference (QMR), a medical diagnosis system that

contains descriptions of nearly 600 diseases. Visitors can browse through the system, using it like an electronic textbook indexed either by disease or by symptom. Alternatively, visitors can retrieve a patient's case, make QMR diagnose it, and compare QMR's hypothesis with one of their own.

We assembled several highly instructive and entertaining "non-real" rule-based systems to demonstrate the capabilities and internal workings of expert systems. In the Haymarket exhibit, visitors haggle with up to three different rule-based storekeepers to buy a large box of strawberries. The simplest, Noah Budge, has only 8 rules and never budges on his price. Eventually, he will kick you out of the store if you don't give him what he's asking for. Visitors can choose Ho Nin with 30 rules and

Nora Logical, the sophisticated storekeeper with over 100 rules. Another rule-based demonstration is a wine-advisor. This proceeds via a two-way spoken conversation. Visitors are asked questions about the type of food planned for the meal and what their tastes are in general. They respond by speaking into a microphone. After up to 10 questions, the computer makes a specific recommendation.

Several rule-based systems dealing with the arts are also on display, including a musical score follower (right) and a drawing expert (below). The goal is to demonstrate the application of rule-based programming techniques in non-technical domains. A computer composition system by Charles Ames generates rock and jazz pieces, which it performs



Photo: Don McCoy/Starbase

An exhibit based on Roger Dannenberg's ConcertCraft program can follow a score and accompany a visitor who performs a simple tune on a keyboard. The score follower has rules that enable it to keep pace with a human performer, even if the player changes tempo and makes mistakes.

AARON is a computer program that draws pictures. The program's knowledge is internally represented by several thousand rules of the form:

*IF: something is the case
THEN: do the following . . .*

A picture develops as AARON threads a complicated path from rule to rule. Small variations in the picture are introduced early in the composition. Since the IF part of the rules depends on what has already been drawn, the same set of rules results in entirely different pictures each time.

Harold Cohen began work on AARON in 1972. In its early phases, the program knew how to build simple forms. It constructed drawings from these forms to produce pictures that evoked an impression of landscapes populated by creatures. In recent years, Cohen has given AARON explicit knowledge about the appearance of plants and human figures. The knowledge is in the form of hundreds of rules of the form:

*IF: the arm is raised
THEN: the palm is facing forward.*

To produce figures that look like people rather than stuffed dolls, AARON has rules that describe posture and balance. Cohen's ambition is to give AARON the knowledge to color its pictures. He says, "it took me 20 years to learn to teach the machine to draw, and I expect it will take me another 20 to teach it how to color."



Photo: Don McCoy/Starbase

Once upon a time.... Joe was in the cave. Irving was in the oak tree. Lucy was in the meadow. The water was in the river. The honey was in the elm tree. The worm was in the ground. The fish was in the river. The hay was in the barn. The berries were in the meadow. Joe was sad. He wanted to become happy. He thought that Lucy liked him. He wanted to persuade her to kiss him. He trusted her. He didn't like her. He decided that if he gives her the hay then then she might kiss him. He wanted to ask her whether if he gives her the hay then she'll kiss him. He wanted to get near her. He went to the meadow. He asked her, "Will you kiss me if I give you the hay?" She knew that he didn't trust her. She decided that if he gives her the hay then she'll tell him that he was stupid. She told him, "If you give me the hay then I'll kiss you." He wanted to get the hay. He wanted to get near the hay. He went to the barn. He took the hay. He had the hay. He wanted to get near her. He went to the meadow. He gave her the hay. She had the hay. He didn't have the hay. She was hungry. She told him, "You're stupid." He didn't like her. She wanted to satisfy her hunger. She ate the hay. She wasn't hungry. She didn't kiss him. He didn't trust her. He was afraid of her. He couldn't persuade her to kiss him. He was still sad. The End.

A tale about Joe Bird and Lucy Lamb spun by Jim Meehan's program **MICRO TALE-SPIN**.

Visitors can challenge computer opponents in four different games. The commercially available chess-playing program **SARGON III** offers a strong game, boasting a rating of nearly 2200 (approaching master level play) at its highest level of play.

COMPUTER CHESS PERFORMANCE

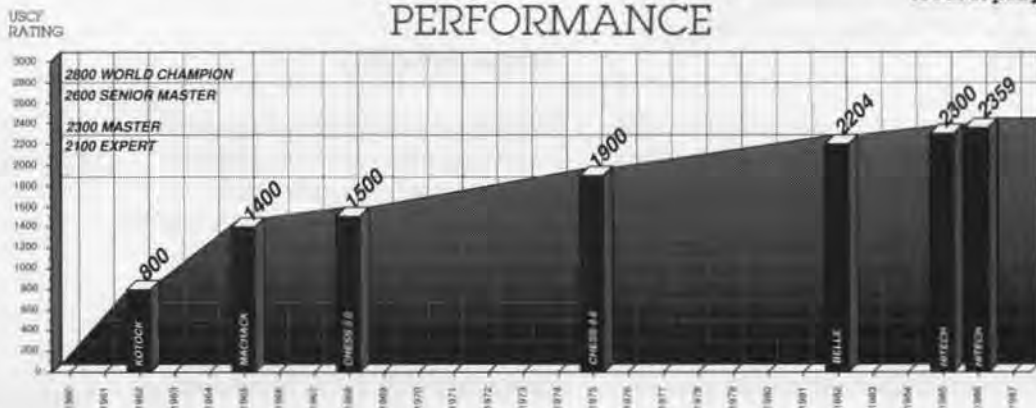

through a Kurzweil 250 synthesizer. After selecting a musical style and a model, such as the twelve bar blues, the program selects instruments and then composes the rhythm, assigning each note a duration that depends in part on whether it is a basic, ornamental or cadence note. Finally, pitches are selected according to a set of about 20 rules. The rules make the notes conform to the harmony, create a melody and avoid repetition. The music is surprisingly convincing.

In contrast to all the systems described above, which represent knowledge as sets of rules, **TALE-SPIN** is based on scripts. This program came from the work of Roger Schank's group at Yale on language understanding. **TALE-SPIN** is a program that generates

stories with a simple "point" somewhat reminiscent of the simpler Aesop's fables. The program simulates a world of characters who do things because they have problems to solve. These consist of fulfilling simple goals, such as satisfying hunger or thirst. Visitors select a main character -- Joe Bear, Irving Bird or Lucy Lamb -- and also determine the goals and character traits of the players. The program has a model of its characters and ensures that their behavior is rational. For example, if Joe Bear is thirsty and sees a river, he will try to get to the river.

In addition to rules, knowledge can be represented as frames, semantic nets and scripts. These are illustrated by panels in the exhibit.

Game-Playing

In addition to being fun, computer games are a valuable testing ground of ways to search through enormous numbers of alternative solutions to a given problem. Typically, when people play a game, they rely on knowledge of the opponent's ability and on an understanding of what it takes to win. Machines, on the other hand, rely on searching many possible moves to determine the best outcome. Research efforts have concentrated on optimizing the search for moves in chess. One approach is to perform the search in the proper order so that unpromising avenues can be eliminated early on. Another approach seeks to give the computer knowledge about chess,

increasing its ability to "size-up" a given position. Hans Berliner and his colleagues at Carnegie-Mellon University used both approaches to build the world's strongest computer chess player. Their program, called Hitech, has custom hardware to generate and evaluate up to 200,000 moves a second. This enables it to search about 11 half-moves ahead while playing in a tournament. In addition, Hitech's board knowledge is equivalent to a search of a further three half-moves.

Visitors can also play tic-tac-toe and five-in-a-row and choose the computer's strategy to be one of look-ahead search, voting or random. The program offers graphics that give an "X-ray" view of the program's deliberations.

A checker player by David Slate can beat all but the most serious players. Finally, in the game "How the West Was Won," the computer plays two roles: opponent and tutor. This is a numbers game, designed to help children gain familiarity with arithmetic. The computer tutor analyzes one's moves and suggests possible improvements. It never scolds or repeats itself and lets the player discover the game for him or herself. This coach was developed as a robust, friendly and intelligent tutor that could work well in the home and classroom.



Photo: Dan McCoy/Rainbow

The computer direction assistant holds a road map of 11 square miles of Boston and Cambridge and can find the quickest route between any two points on its map. Visitors communicate directly with the computer via a touch-tone telephone. The assistant is very forgiving of mistakes and provides instructions in good, clearly-spoken English.

Robot Sensing

Giving robots sensory capabilities is an important part of the effort to endow robots with intelligence. A smart robot must find its way independently and cope with the unexpected. It can only begin to do this if it can sense the distance to any surrounding obstacles, feel if it is touching something, or analyze pictures taken with an onboard camera. Many of the historic robots acquired by the Museum and on display in the exhibit's Smart Machines Theater were built as experiments, allowing researchers to explore how a robot can gather and make good use of sensory data.

The Museum visitor can experiment with four robot senses: vision, hearing, touch and sonar. Human vision is so sophisticated that we hardly appreciate its complexity. For example, just consider how we can instantly recognize everyday objects, such as a tree or cat, even though no two examples look alike in detail. Our vision relies on a great deal of knowledge about the world and about what we expect to see. By contrast, machines rely



Photo: Dan McCoy/Rainbow

Visitors can experiment with a vision system by placing some simple shapes under a camera and watching how it first looks for edges and then tries to identify the shapes.



Photo: Dan McCoy/Starbrow

While wheels work well on roads, legs are needed to cross rough terrain. Perhaps the most spectacular demonstration in the exhibit is Marc Raibert's one-legged hopper. This robot balances itself on the move, rather like a person balancing a broom on a fingertip. A computer keeps track of its speed and position, adjusting the angle of the leg to keep the robot upright. An accompanying video shows one-legged, two-legged and four-legged running machines, as well as a series of legged walking robots.

mainly on the details of the actual image, analyzing it first to find edges, and identifying objects by their outlines. This approach makes machines better at matching complicated abstract patterns, such as fingerprints.

Part of a fingerprint recognition system used by police departments all over the world is on display. Visitors try to match a fingerprint on the screen with one of several prints displayed on the wall from famous criminals. The computer then shows how it would make the match, using the points where ridges start or fork to classify the pattern accurately.

Speech recognition systems can give computers a reasonable sense of hearing, particularly if the machine has been trained by the speaker. Visitors can use several systems, including one that can be trained to respond to the visitor's voice. Even after training, computer speech recognition is limited to a few thousand words at most and gener-

ally requires the speaker to pause briefly between each word. In both speech recognition and vision, computers have yet to match the ability of a two-year old child.

A sense of touch is needed by a robot hand when it tries to grasp a delicate object. A pressure sensitive pad mounted on the robot gripper can gauge the amount of pressure being applied. Visitors see the pressure of their fingers on a pad displayed as an array of colors on a screen.

Finally, visitors can try out a sense that humans do not have - sonar. Robots use sonar to gauge the distance to surrounding walls and obstacles. The sensor emits pulses of extremely high-pitched sound, which reflect off an object and are picked up by the detector. The sound's round trip travel time indicates the distance to the object. In the exhibit, a ceiling mounted sensor measures a visitor's height by bouncing a signal off the top of the head.



Photo: Dan McCoy/Starbrow

Ken Salisbury's three-fingered hand is featured in a video on robot hands. Built at M.I.T. in 1982, it can be instructed to hold an object with a constant force, thereby achieving a delicate but secure grasp. Feedback is obtained by means of a pressure-sensitive rubber layer that covers the fingertips.

Mobile Robots

In addition to its sensing ability, an intelligent, independent robot must have a suitable drive system and should be able to form and achieve goals. All the mobile robots on display in the exhibit are equipped with a drive system. Most have some form of sensing, but only Shakey seriously attempted the last and hardest requirement of forming plans and reasoning.

A mobile robot from Real World Interfaces roams around a cage, using sonar to sense and map the walls and obstacles. Visitors can try to override the robot's good sense by controlling its movement with a joystick, but it will never let itself collide with a wall. In addition, about 25 robot toys are on display and can be tried out by visitors. Most have wheels, but several can walk; some have bump sensors, or respond to claps or squeezing.

Robot Arms

Robot arms and hands attempt to replicate aspects of human manual dexterity. Arms are by far the most common type of robot. They perform a wide range of industrial tasks, from the tiny movements for assembling a wristwatch to the large powerful movements required to stack heavy cartons. In the exhibit, the real industrial arms are shown on video, and smaller, educational arms are operated by visitors.

Two robot hands are on display: the five-fingered Tomovic hand attached to the tentacle arm pictured on the front cover, and a three-fingered soft gripper from Shigeo Hirose at the Tokyo Institute of Technology.

An ingenious way to achieve responsive compliance was invented at the Draper Laboratories. Their system uses an arrangement of springs that greatly eases tasks such as putting a peg into a tightly fitting hole. With a stiff wrist, a robot would jam the peg and only make it worse by pushing harder. With the compliant wrist, however, the peg finds its way into the hole smoothly. Visitors can use a compliant wrist to try this out for themselves.

A major thrust of industrial development is to tighten the link between the design and manufacture of a product. Using a computer-aided design system, an industrial designer can create a product and then send instructions for making that product directly to a numerically controlled tool or to a robot. Visitors can experiment with this process by designing a log cabin made of lincoln logs. When the design is complete, the cabin is constructed automatically by a pair of simulated robots on a screen. Real robots would need to be guided by a vision system to ensure that the logs were positioned accurately. This is demonstrated in an adjacent display in

An application mobile robots have already found is that of night watchman. The gallery's Sentry robot by Denning Mobile Robotics can carry TV cameras, infrared sensors and microphones to detect an intruder. The information it collects is radioed to a security office. Microwave beacons supplement the Sentry's onboard sonar, enabling it to patrol a path hundreds of feet long for hours on end without ever losing an exact knowledge of its position. In the exhibit, the Sentry patrols a short path, avoiding obstacles in its way. Its TV camera relays signals to another robot, the Hubot, whose onboard TV monitor displays the picture.



which a vision system guides a robot arm that assembles a toy boat from its parts. Both these displays were provided by the University of Lowell's Center for Productivity Enhancement.

The Future

The exhibit can be readily updated as new items become available. A large industrial arm has already been offered to us by Cincinnati Milacron, and we hope to be able to demonstrate an industrial application. We welcome suggestions from our members and visitors!



The Mitsubishi Movemaster uses its five joints and a gripper to pick up letter blocks and arrange them to spell a word typed in by the visitor. The arm is normally used for assembly or for handling chemicals.

Special thanks to the Institutions and Individuals who gave time, machines, programs and other materials to make Smart Machines possible.



Photo: Fry Foto.

Gordon Bell and Russell Nofstker cutting the ribbon at the June 18th Smart Machines opening.

Funded by major grants from:

Russell Nofstker, Chairman, Symbolics, Inc. The Founders of Symbolics, Inc. C. Gordon Bell, National Science Foundation The Xerox Foundation, Stamford, CT

Flexible Manufacturing Systems, Inc., Los Gatos, CA
 FMC Corporation, Santa Clara, CA
 Ford Motor Company, Dearborn, MI
 General Motors Research Laboratory, Warren, MI
 Gold Hill Computers, Cambridge, MA
 Gulton Industries, Inc., Plano, TX
 Hewlett-Packard, Cupertino, CA
 Houghton Mifflin Company, Boston, MA
 IBUKI, Los Altos, CA
 Imaging Technology Inc., Woburn, MA
 International Business Machines, Armonk, NY
 Jet Propulsion Laboratory/NASA, Pasadena, CA
 Johns Hopkins University, Laurel, MD
 Kurzweil Applied Intelligence, Inc., Waltham, MA
 Kurzweil Foundation, Waltham, MA
 Kurzweil Music Systems, Waltham, MA
 Learning Company, Menlo Park, CA
 Living Videotext Inc., Mountain View, CA
 Massdata, Inc., Boston, MA
 Massachusetts Institute of Technology, Cambridge, MA
 Maxell Corporation of America, Moonachie, NJ
 Mindscape, Inc., Northbrook, IL
 Museum of Science, Boston, MA
 Natural Language Inc., Berkeley, CA

Naval Systems International (Benthos/Deep Sea Systems), Falmouth, MA
 NEC Home Electronics USA, Inc., Chicago, IL
 NEC Information Systems, Inc., Boxborough, MA
 New England Telephone Company, Boston, MA
 Odesta Inc., Evanston, IL
 Odetics Inc., Anaheim, CA
 Ohio State University, Columbus, OH
 OWI Inc., Compton, CA
 Play Jour, New York, NY
 Polaroid Corporation, Cambridge, MA
 Raster Technologies Inc., Westford, MA
 Raymond Industries, Agawam, MA
 Real World Interfaces, Lyndeborough, NH
 Rehabilitation Institute of Pittsburgh, Pittsburgh, PA
 RobotCalc, Naperville, IL
 Robotic Systems International, Sidney, BC, Canada
 Scholastic Inc., New York, NY
 Sequent Computer Systems, Inc., Beaverton, OR
 Shape, Inc., Biddeford, ME
 Smithsonian Institution, Washington, DC
 Spinnaker Software, Inc., Cambridge, MA
 SRI International, Menlo Park, CA
 Stanford University, Stanford, CA

Sun Microsystems, Inc., Mountain View, CA
 Symantec Inc., Cupertino, CA
 Symbolics, Inc., Cambridge, MA
 Tandy/Radio Shack, Fort Worth, TX
 Technical Database Corporation, Conroe, TX
 Technomatix, Birmingham, MI
 Teknowledge, Inc., Palo Alto, CA
 Tektronix, Beaverton, OR
 Thermwood Corporation, Dale, IN
 Thinking Machines, Inc., Cambridge, MA
 Tokyo Institute of Technology, Tokyo, Japan
 Tonka Toys, Minnetonka, MN
 Tufts-New England Medical Center, Boston, MA
 United States Robots, Carlsbad, CA
 University of Lowell, Lowell, MA
 University of Tokyo, Tokyo, Japan
 University of Utah, Salt Lake City, UT
 Waseda University, Tokyo, Japan
 Wentworth Institute of Technology, Boston, MA
 Xerox Corporation, Stamford, CT
 Zenith Data Systems, Glenview, IL

Individuals:

Warren Adam
 Al Adams
 Mark Allen
 Charles Ames
 Charles Balmer
 Sterling Barnett
 Joseph Bates
 Bruce Buchanan
 Tom Callahan
 Howard Cannon
 Greg Carlson
 Adam Lloyd Cohen
 Harold Cohen
 Raymond Cote
 Tom Courtney
 Curt Crittendon
 Roger Dannenberg
 Jim Davis
 Randall Davis
 Ed Demmler
 Michael Domino
 Ed Feigenbaum
 Steve Foster
 Karen Frenkel
 Steve Golson
 Michael Halle
 Liz Haywood Sullivan
 Carl Helmers
 Shigeo Hirose
 Henry Holtzman
 Berthold Horn
 Icharo Kato
 Takeo Kanade
 Tom Knight
 Jim Kocher
 Patrick Krolak
 Stephen Kukulich
 Bob Lee
 Peter McA Nulty
 Jim Meehan
 David Michaud
 Randall Miller

Marvin Minsky
 Hirofumi Miura
 Stephen Moore
 Hans Moravec
 Grinnell More
 Penny Nii
 Stephen Pauker
 George Pelyak
 Jonathan Press
 Marc Rubert
 Mitchel Resnick
 Alan Rifkin
 Bernard Roth
 Brian Sandberg
 Penny Sander
 Fern Sandhouse
 Victor Scheinman
 Marc Sidell
 Dan Sieworek
 David Silver
 Isao Shimoyama
 David Slate
 Frank Sonnenberg
 Alan Symonds
 Franklyn Turbak
 Leonardo Torres Quevedo
 Barry Vercoe
 Linda Webb
 Joseph Weizenbaum
 Carl West
 Richard Weyhrauch
 Brian Wilcox
 David Zeltzer

Institutions:

3COM, Santa Clara, CA
 AC&R/DHB & Bess, New York, NY
 Advanced Technology Systems, E. Providence, RI
 Apple Computer Corporation, Cupertino, CA
 Automatrix, Inc., Billerica, MA
 Axlon, Inc., Sunnyvale, CA
 Barry Wright Corporation, Watertown, MA
 Boris Color Laboratories, Boston, MA
 Carnegie-Mellon University, Pittsburgh, PA
 Charles Stark Draper Laboratories, Cambridge, MA
 Chedd Angier Productions, Watertown, MA
 Coleco Industries, West Hartford, CT
 Contaq Technologies Corporation, Bristol, VT
 Denning Mobile Robotics Inc., Woburn, MA
 Digital Equipment Corporation, Maynard, MA
 Dragon Systems, Newton, MA
 Fisher America, Fairfield, NJ

Thank You!

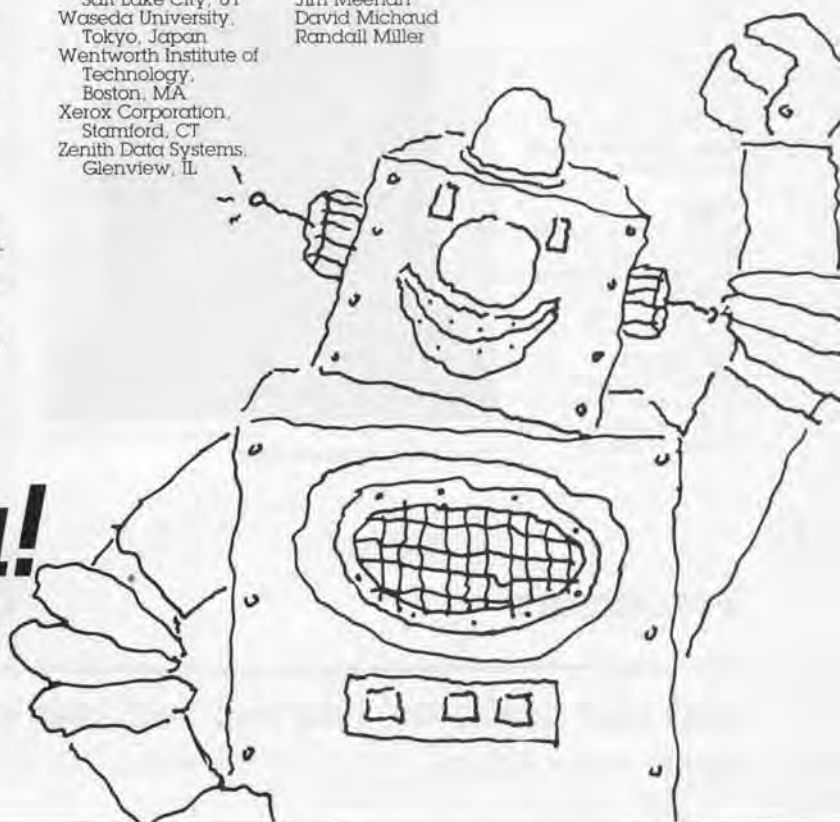

A Historical Timeline of Artificial Intelligence and Robotics

Gwen Bell and Leah Hutten

The Smart Machines exhibition has two historical components. A timeline, on display at the entrance to the exhibit, chronicles the major milestones to 1979. The Robot Theatre displays a collection of historic robots through the early 1980s. This article is intended as a synthesis of these two exhibits.

Precursors

1738

Jacques de Vaucanson builds a mechanical duck to tour and raise money for the inventor's experiments for creating life artificially. The copper duck quacks, bathes, drinks water, eats grain, digests it, and voids.



Courtesy of Bellefire Archives
Drawing of de Vaucanson's duck.

1818

The book, *Frankenstein*, by Mary Shelley, includes the first description of creating a man-made being, who becomes a fearful monster.

1900

At the Paris World's Fair, Torres y Quevedo demonstrates an electro-mechanical machine that can play selected chess end games.

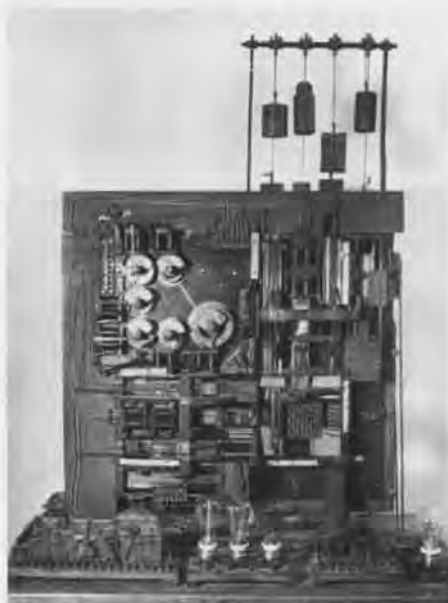

Photo courtesy of Leonardo y Quevedo
Torres y Quevedo's chess player.

1920

Karel Capek writes the play *R.U.R.* (Rossum's Universal Robots) in which robots are produced by an Englishman named Rossum. The name, Rossum, is derived from the Czech word for

reason, while robot is a Czech word for worker. The popularity of the play led to the widespread adoption of the word robot.

1942

Isaac Asimov publishes "Runaround" in the March issue of *Astounding*, in which he introduces the Three Laws of Robotics.

This is the first known use of the term "robotics."

1943

Warren McCulloch and Walter Pitts propose that the behavior of the brain can be treated as a network of neurons that behave like on-off switches.

1947

Only a year after the completion of ENIAC, the first electronic computer, Arthur Samuel proposes to build a computer to play checkers.

1948

Norbert Wiener coins the term cybernetics, a philosophical perspective for describing interacting systems in terms of exchange of information.

1949

The Debate Begins: Can Machines Think?

On June 9, at Manchester University's Lister Oration, British brain surgeon Sir Geoffrey Jefferson

states, "Not until a machine can write a sonnet or compose a concerto because of thoughts and emotions felt, and not by the chance fall of symbols, could we agree that machine equals brain — that is, not only write it but know that it had written it. No mechanism could feel (and not merely artificially signal, an easy contrivance) pleasure at its successes, grief when its valves fuse, be warmed by flattery, be made miserable by its mistakes, be charmed by sex, be angry or miserable when it cannot get what it wants."

On June 11, *The London Times* quotes the mathematician Alan Turing, "I do not see why it (the machine) should not enter any one of the fields normally covered by the human intellect, and eventually compete on equal terms. I do not think you can even draw the line about sonnets, though the comparison is perhaps a little bit unfair because a sonnet written by a machine will be better appreciated by another machine."



Illustration courtesy of Alan Turing
The Turing test.

Precursors

The Debate Begins: Can Machines Think?

1738 1818 1900 1920 1942 1943 1947 1948 1949

In New York, Claude Shannon's paper to the Institute of Radio Engineers proposes two computer chess strategies that are still in use. The first is to look at all the choices up to a fixed depth and the second is to look at a selected few to greater depth.

In the 1950s robots and artificial intelligence (A.I.) start evolving along separate tracks.

1951
Turing creates a standard test to answer: "Can machines think?" If a computer, on the basis of written replies to questions, could not be distinguished from a human respondent, then it must be "thinking."

1954
George C. Devol, Jr., applies for the first US patent for an industrial robot. He calls it "unimation" for short.

1956
John McCarthy of Dartmouth convenes the Dartmouth Summer Research Project on Artificial Intelligence, marking the birth of the field.

Herbert Simon, Allen Newell, and J.C. Shaw write "Logic Theorist," one of the earliest programs to investigate the use of heuristics in problem solving.

1957
John McCarthy and Marvin Minsky found the first artificial intelligence laboratory at M.I.T.

Simon, Newell and Shaw write the pioneering, "General Problem Solver." It is the first program that solves a problem that it hadn't been specially programmed to solve.

1958
Simon, Newell and Shaw design and use the first list processing program, IPL-V.

1959
McCarthy creates LISP. Unlike other current programming languages, LISP is designed to work with English words and phrases. A key feature is that the data and programs are simply lists in parentheses, allowing a program to treat another program — or itself — as data. This characteristic greatly eases the kind of programming that attempts to model human thought.

Frank Rosenblatt invents an ingenious evidence-weighting machine called a "Perceptron." It is supposed to recognize patterns by their parts without regard to their relationships.

In the 1960s, the Department of Defense Advanced Research Project Agency (DARPA) provides large-scale funds for artificial intelligence research at Carnegie-Mellon

University, Massachusetts Institute of Technology and Stanford University.

Joe Engelberger, the entrepreneur, works tirelessly to get Joseph Devol's ideas for industrial robots into use. Engelberger eventually earns the title "Father of Robotics."

1961
James Slagle writes a Symbolic Automatic Integrator (SAINT) to solve elementary symbolic integration problems at the level of a good college freshman.

SAD-SAM (Syntactic Appraiser and Diagrammer — Semantic Analyzing Machine) is programmed by Robert Lindsay at Carnegie Institute of Technology. The program accepts English sentences about kinship relations, builds a data base and answers questions about the facts it has stored.

SAD-SAM INPUT:
John is Mary's son.
SAD-SAM OUTPUT:
Mary's brother is John's uncle; Mary's mother is John's grandmother, etc.

1962
Engelberger founds Unimation, the first industrial robot company. The Unimate Mark II robot welcomes visitors into the Museum's Smart Machines Gallery.

Samuel's checkers program, which has the ability to learn from its mistakes, plays at the masters level.

1963
McCarthy leaves M.I.T. and founds Stanford University's artificial intelligence laboratory.

At Rancho Los Amigos Hospital an orthotic arm is designed to aid a paralyzed person.

community. The PDP-6's architecture is particularly suited for running LISP programs.

Edward Feigenbaum and Bruce Buchanan conceptualize expert systems and start the Dendral project.



Rancho Arm, on loan from Stanford University, Stanford, Calif.

Stanford University modifies the Rancho Arm to be controlled by a computer.

1965
A five fingered aluminum prosthetic hand is developed by Rajko Tomovic at The University of Belgrade.

The PDP-6 becomes the work-horse machine for the artificial intelligence

Hubert Dreyfus' paper "Alchemy and Artificial Intelligence," is published by The Rand Corporation. His assertion that "Even though machines can perform intelligent tasks, the evidence against their ever becoming able to be really, humanly intelligent, is overwhelming," leads to debates and research that continue into the 1980s.



Tomovic Hand, on loan from Tom Callaghan.



Unimate courtesy of National Museum of American History, Smithsonian Institution.

McCarthy Creates LISP



Photo: Johns Hopkins University

Beast, gift of Johns Hopkins University, Laurel, MD.

Scientists at Johns Hopkins University create the Beast (Mod II) as an experiment to replicate animal behavior in a robot. When it gets "hungry" (low batteries), it uses sonar and a photo-cell array to find "food" (wall power outlets). Pressure-sensitive switches perform the fine guiding of its prongs into the wall socket.

Victor Scheinman and Larry Leifer build the "Orm," Norwegian for snake. This robot arm moves by selectively inflating groups of its 28 air sacks sandwiched between seven metal disks. Its design is later abandoned because its movements could not be repeated accurately.

The Stanford Cart is built at the A.I. Lab to simulate a remotely controlled Moon rover.

1966
The program ELIZA, written by Joe Weizenbaum at M.I.T., tries to assume the role of a nondirective therapist. It turns sentences into

questions and responds to key words about feelings and family.

Richard Greenblatt's Machac is the first machine to achieve a Class C rating in the National Chess Association (approaching the level of a serious weekend amateur player).

working with Chemist and Nobel Laureate Joshua Lederberg, complete DEN-DRAL, an expert system for generating explanatory hypotheses in organic chemistry.

Marvin Minsky constructs the 12-jointed Tentacle Arm, which can reach around obstacles. A PDP-6 computer is used

Bruce Buchanan and Edward Feigenbaum,



Photo: Dan McCoy/Bainbow

Orm, on loan from Stanford University, Stanford, Calif.

1967
Television cameras controlled by a remote computer are added to the Stanford Cart, permitting it to follow a white line on a road.

1968
Engelberger travels to Japan and grants Kawasaki the right to build Unimates in exchange for royalties. These are the first robots built in Japan.

for control and hydraulic fluids for power.

Seymour Papert writes "The Artificial Intelligence of Hubert L. Dreyfus: A Budget of Fallacies." In it, he states, "It is cowardice to ... assure us that the computer is barred by its finite number of states from encroaching further into areas of activity ... (regarded) as 'uniquely human'."

1969
Shakey, the first integrated robot system equipped with a TV camera and other sensors, slowly roams through the rooms of The Stanford Research Institute, guided by the remote radio control of an SDS-940 computer.

The Original Stanford Arm, the first successful electrically-powered computer-controlled robot arm, is constructed by Victor Scheinman. It is used to develop industrial assembly techniques for robots.



Photo: Fvy Foto

12-jointed Tentacle Arm, on loan from Massachusetts Institute of Technology, Cambridge, MA.

In the 1970s, A.I. is recognized as a computer science discipline, and industrial robots are put to work in factories around the world.

1970
200 people attend the first meeting of the International Joint Conference on Artificial Intelligence (IJCAI).

Terry Winograd integrates natural language understanding and knowledge about a world of table top blocks in SHRDLU, written for his doctoral thesis at M.I.T.

1971
France installs its first industrial robot, a Unimate, at Renault's R-5 plant to build LeCar.

Stanford Research Institute gives Shakey the ability to reason about its actions. Shakey radios information from its sonar and bump sensors to a room-sized computer (DEC PDP-10 and PDP-15), which sends back commands to make Shakey move. The computer spends about half an hour to move Shakey one meter.

DARPA funds a \$15 million, five-year research program to achieve a breakthrough in speech understanding.



Photo: Dan McCoy/Bainbow

Stanford Arm, on loan from Stanford University, Stanford, CA.

Industrial robots are put to work in factories around the world.

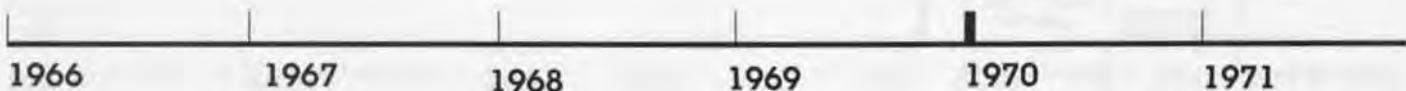

1972

At the University of Aix-Marseille, Alain Colmerauer develops the use of formal logic as a programming language. PROLOG.

LUNAR, a natural-language information retrieval system, is completed by Woods, Kaplan, and Nash-Webber at Bolt, Beranek and Newman. LUNAR helps geologists access, compare and evaluate chemical-analysis data on moon rock and soil composition from the Apollo 11 mission.

1973

Yorick Wilks writes the first acceptable language translation program, which produces respectable French from small English paragraphs.

1974

The first commercially available mini-computer controlled robot, T3, is produced by Cincinnati Milacron.

The first World Computer Chess Tournament is held.

CONS, the first computer built to optimize LISP, is completed by Tom Knight at M.I.T.'s A.I. Lab. It is the precursor of CADR and the commercial machines built at LMI and Symbolics.

1975

MARGIE (Meaning Analysis, Response Generation, and Inference in English) is developed by Roger Schank and his students at the Stanford A.I. Laboratory.



Photo: courtesy of NASA/JPL

Mars Rover Prototypes, on loan from NASA/Jet Propulsion Laboratory, Pasadena, CA.

Minsky develops the concept of frames as a convenient way to represent specific objects or concepts. Each frame consists of a name and a series of slots that describe the object's or concept's attributes.

Unimation has its first profitable year.

1976

The DARPA speech goals are met by the HEARSAY speech program developed at Carnegie-Mellon University under the direction of Raj Reddy. It beats DARPA's goal of understanding 90% of ordinary continuous speech using a vocabulary of 1000 words.

1977

Hans Moravec equips the Stanford Cart with stereo vision. A television camera that moves along a rail takes pictures of a given scene from several different angles, enabling the Cart to find the distance to obstacles in its path.

In the USA, Robert McGhee develops a hexapod walking machine controlled by a

digital computer. In the USSR, scientists develop a hexapod walker controlled by a hybrid (analog and digital) computer.

EMYCIN developed by William Von Melle, Edward Shortliffe, Bruce Buchanan, and Edward Feigenbaum is the first expert system "shell." A shell is a program that provides the framework for developing an expert system. The user supplies his own rules to build an expert system in the subject of his choice.

The programs SAM (Script Applier Mechanism) and PAM (Plan Applier Mechanism) are developed by Roger Schank. Robert Abelson and their students at Yale University. SAM and PAM demonstrate the understanding of stories by using scripts and plans.

The Jet Propulsion Laboratory builds two Rover prototypes designed to explore Mars. To stay upright, the Hardware Prototype has caterpillar tracks mounted on flexible legs.



The Software Prototype has both sensing ability and intelligence.

1978

The Mars Rover project is cancelled because NASA opts for a manned space program.

GM unveils its production line, which uses a programmable universal machine for assembly (PUMA) system based on the Scheinman arm.

Hans Berliner's backgammon program wins the world championship.

Consight-I, by Steven Holland, Lothar Rossol and Mitchel Ward, is able to identify and sort randomly oriented parts on a moving factory conveyor belt. When the parts move under two converging light beams, the beams are split in two. This pattern is detected by a computer connected to a television camera. Consight-I consists of a Vicarm robot arm controlled by a PDP 11/45 computer. Commercial versions use an arm by Cincinnati Milacron.



Photo: General Motors Research Laboratories

Consight, gift of General Motors Research Laboratories, Warren, Mich.

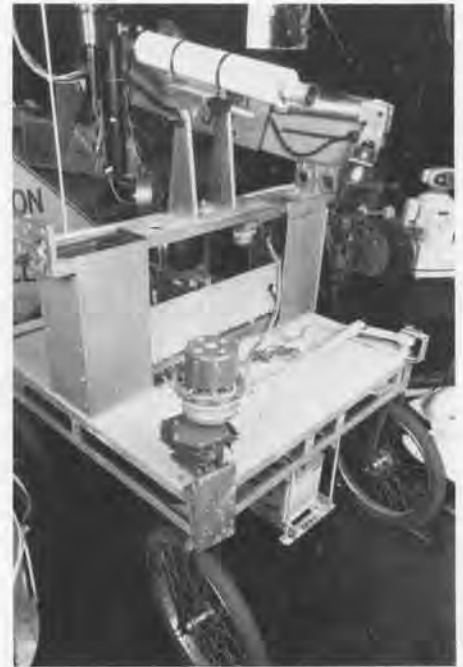

Photo: Dan McCoy/Stanford

Stanford Cart, on loan from Stanford University, Stanford, CA.

The first World Computer Chess Tournament is held.

1972 1973 1974 1975 1976 1977

1978 1979

CONTEMPORARY ROBOTS FROM THE MUSEUM'S COLLECTION

1981

Avatar represents a breed of personal home robots that evolved following the microcomputer revolution in the early 1980s. This robot can move without bumping into things, talk, and handle objects with its arm.

1981

The first direct drive (DD) arm by Takeo Kanade served as the prototype for DD arms used in industry today. The electric motors housed inside the joints eliminate the need for chains or tendons used in earlier robots. DD arms are fast and accurate because they minimize friction and backlash.

1981

One of three of Shigeo Hirose's robots at the museum, the quadruped can perform a complicated task such as "feeling its way" up stairs of varying heights. It has contact sensors on the sides and

bottom of its feet. When these are touched, the quadruped responds with animal-like reflexes. Each leg contains an elegant mechanical device that translates small motor movements inside the body into larger movements of the legs.



Photo courtesy of Takao Kanade

Direct Drive Arm-1,
gift of Carnegie-Mellon
University, Pittsburgh, Pa.



Photo courtesy of Charles Balmer Jr.

Avatar on loan from Charles Balmer, Jr., Urbana, Ohio

**Direct
Drive
Arm-1**

1981

Page 16 Summer/Fall 1987

Odex-1

1983



Photo courtesy of Odex, Inc., Anaheim, Calif.

Odex-1 on loan from the Smithsonian Institution, Washington, D.C.



Photo courtesy of Shigeo Hirose

Titan III (Quadruped) on loan from the Tokyo Institute of Technology, Tokyo, Japan

1983

Odex is the first commercially available walking robot. It can work in dangerous places inaccessible to vehicles with wheels. These include radioactive zones in nuclear power stations, military battlefields, and underground mines. Its legs can also serve as arms for lifting and moving objects.

1985

Underwater rovers explore the ocean depths under remote control. The famous Titanic wreck was explored by a large rover called Argo, but most underwater rovers are used for more routine inspection tasks. The Sea Rover, designed by Christopher Nicholson, can dive to depths of up to 120 meters and travel at 1.5 knots while relaying color video pictures from under the sea.



Photo courtesy of Naval Systems International, A

Sea Rover, gift of Naval Systems International, a joint venture of Deep Sea Systems and Benthos, Inc., Falmouth, Mass.

1985

The Computer Museum Report

Calendar *Fall 1987*

- Oct 4**
Sunday
3 PM
Britain's First Commercial Computer, The Leo 1
John M. M. Pinkerton, McLean Pinkerton Associates
The use and design of Leo 1 will be illustrated with a period film and a talk by its chief engineer.
- Oct 11**
Sunday
3 PM
The Society of the Mind: A Psychological Look at Artificial Intelligence
Professor Marvin Minsky, MIT
- Oct 18**
Sunday
2-4 PM
Whirlwind's Genesis and Descendants
A panel discussion by the pioneers that built the Whirlwind computer at MIT and subsequently carried on the research and development at the MIT Lincoln Laboratory.
- Nov 1**
Sunday
3 PM
Robots: A Recapitulation of Life
Professor Hans Moravec, Carnegie-Mellon University
An illustrated lecture by one of the field's innovators.
- Nov 6-8**
Computer Games Weekend
Classic and contemporary games will be available all weekend in the Museum galleries.
25th Birthday Party of Interactive Computer Games
Panel Discussions: Computer Games, Past, Present and Future
- Fri night**
Saturday
Sunday
Second International Core Wars Competition
MicroMouse Demonstrations

New From The Computer Museum Store

The New Computer Museum Slide Rule Tie Bar
The perfect gift for every math-minded man. This tie bar is based on the real thing, complete with A, C, and D scales and a moveable cursor. Handsomely finished in antique gold. \$22.50 post-paid (Members \$20.25)

YES! I want to become a Member of The Computer Museum.

- \$20 Student \$ 45 Family \$250 Sponsor
 \$30 Individual \$100 Donor \$500 Patron

Members receive free admission for one full year, invitations to exhibit previews, advance notice of exhibitions and lectures, invitations to members-only events, a subscription to our exciting quarterly magazine, The Computer Museum Report, and a 10% discount in the Museum Store.

Enclosed is my check, made payable to **The Computer Museum** for \$ _____

or charge to: VISA MasterCard American Express

Card # _____ Expiration Date _____

Signature _____

Name _____

Address _____

City _____ State _____ Zip _____

Contributions are tax-deductible to the extent provided by the law.

The Computer Museum

The Computer Museum is a non-profit 501(c)3 foundation that chronicles the evolution of information processing through exhibitions, archives, publications, research and programs.

Museum Hours: *Summer:* Open daily 10 - 5, Friday 10 - 9. *Winter:* Open Tuesday - Sunday 10 - 5, Friday 10 - 9. Open Mondays during Boston school vacation weeks, 10 - 5. Closed Thanksgiving, Christmas, and New Years Day. Hours are subject to change.

Membership All members receive a membership card, free subscription to The Computer Museum Report, a 10% discount on merchandise from The Computer Museum Store, free admission and invitations to Museum previews. For more information contact Membership Coordinator at The Computer Museum, 300 Congress Street, Boston, MA 02210. Telephone (617) 426-2800.

Staff

Joseph F. Cashen, *Executive Director*

Dr. Gwen Bell, *Founding President*

Lynn Hall, *Registrar*

Tom Merrill, *Exhibits Technician*

Dr. Oliver Strimpel, *Curator*

Michael Bergman, *Exhibit Specialist*

Dr. Leah Hutten, *Exhibits Developer*

Marc LeBlanc, *Exhibits Intern*

Bonnie Turrentine, *Education Director*

Megan Hayes, *Education Specialist*

Kurt Levitan, *Education Assistant*

Gregory Schroeder, *Operations/Visitor Coordinator*

Mark Hunt, *Marketing Director*

Gail Jennes, *Public Relations Manager*

Laura Goodman, *Store Manager*

Robert Gates, *Assistant Store Manager*

Nicole Chang, *Weekend Store Manager*

Linda Holekamp, *Communications Assistant*

Kathleen Keough, *Functions Manager*

Michael N. Oleksiw II, *Development Director*

Scott Reilly, *Development Assistant*

Susan Versailles, *Membership Coordinator*

Matt Murray, *Interim Business Manager*

Vannette Bastien, *Accountant*

Line Lochar, *Office Coordinator*

Germain DRK,

Public Relations Advisors

Abott Ames Advertising,

Advertising Consultants

Michael Sand, Inc.,

Exhibit Planning Consultants

Steve Nelson/Fay Foto,

Dan McCoy/Rainbow, *Photography*

The End Bit 000000000000000001

BIPER-3, designed by Hirofumi Miura and Isao Shimoyama in 1981, was the first legged machine to balance itself dynamically.

Like a person, its gait relies on its own forward momentum. It has stilt-like legs and uses its hips to pick up its feet. This gives the machine a pronounced shuffling gait like Charlie Chaplin's stiff-kneed walk.

BIPER-3 can walk forward, backward, or sideways.

On loan from the University of Tokyo, Tokyo, Japan

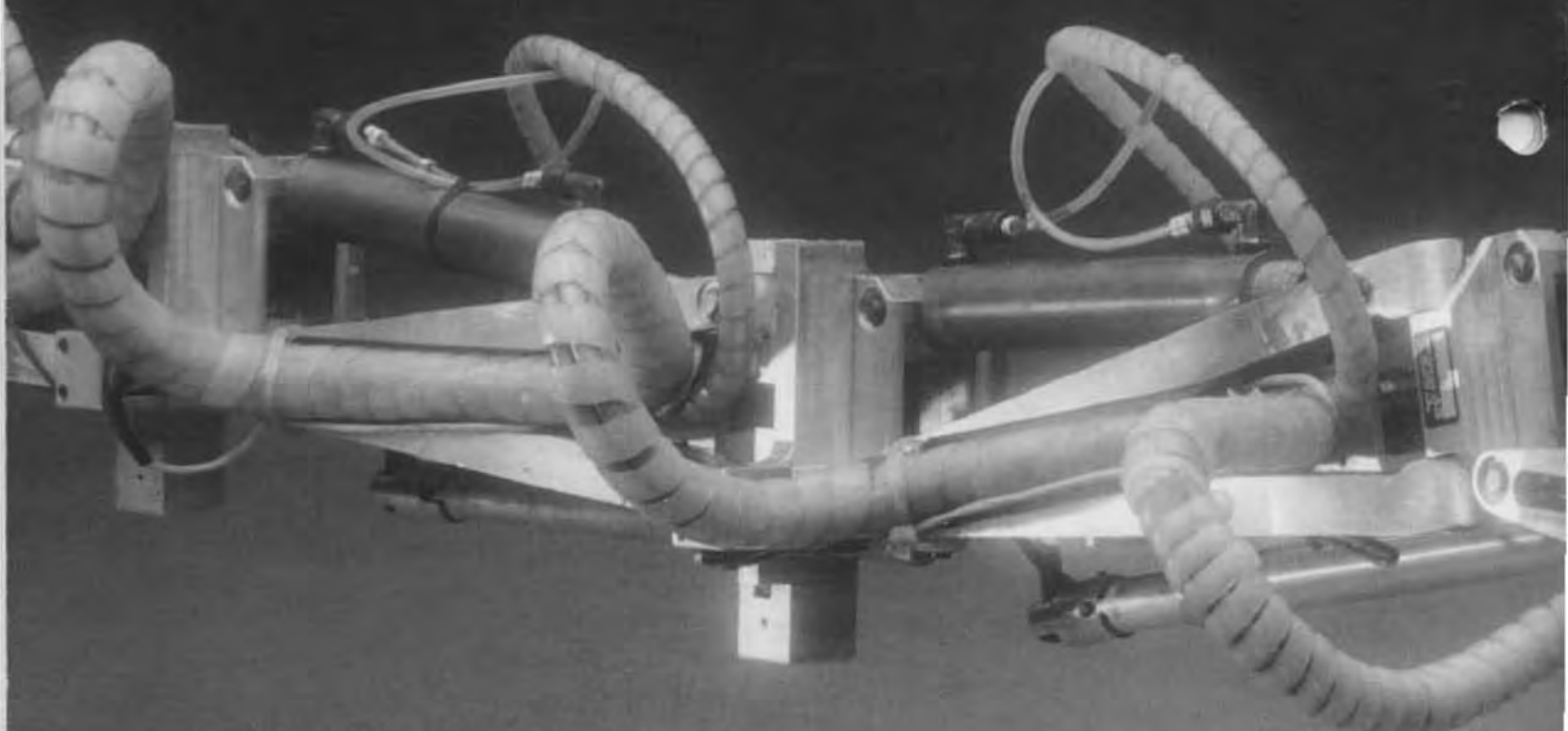
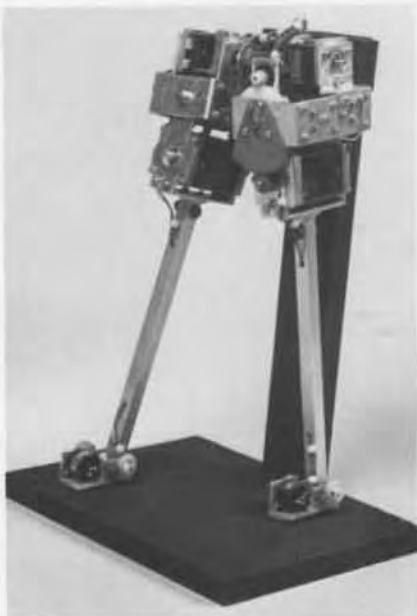

Address Correction Requested

Non-Profit
Organization
U.S. Postage
PAID
PERMIT NO. 110
FITCHBURG, MA.
01420

Board of Directors

John William Poduska, Sr.
Chairman
Stella Computer Inc.
Joseph F. Cashen
Executive Director
The Computer Museum
Gwen Bell
Founding President
The Computer Museum
Erich Bloch
National Science
Foundation
Lynda Schubert Bodman
Schubert Associates
David L. Chapman
Cullinet Software, Inc.
David Donaldson
Ropes and Gray
John J. Evans
Manufacturers
Hanover Trust
Sydney Fernbach
Computer Consultant
William Foster
Status Computer
Thomas Gerrity
Index Systems, Inc.
Gardner Hendrie
Sigma Partners
Max D. Hopper
American Airlines
Arthur Humphreys
ICL
Mitchell Kapor
Kapor Enterprises Inc.
August Klein
MASSCOMP
Koji Kobayashi
NEC Corp.
Robert Lucky
AT&T Bell Laboratories
J. Carl Mast
International
Data Corporation
James I. McKenney
Harvard Business School
Carver Mead
California Institute
of Technology
Robert M. Metcalfe
3Com Corp.
Arthur P. Molitella
The National Museum
of American History
Smithsonian Institution
Laura Barker Morse
Russell Reynolds
Associates
David Nelson
Apollo Computer, Inc.
Russell Nofstker
Symbolics, Inc.
Nicholas Pettinella
Intermetrics, Inc.
Jonathan Rotenberg
The Boston Computer
Society
Jean E. Sammet
IBM
Edward A. Schwartz
Digital Equipment Corp.
National Seligman
The Research Board
Paul Severino
Wellfleet Communi-
cations, Inc.
Hal Shear
Pell Rudman & Co. Inc.
Irwin J. Sittian
Aetna Life & Casualty
Ron Smart
Digital Equipment Corp.
William J. Spencer
Xerox Corp.
An Wang
Wang Laboratories, Inc.

Trustees

Charles Bachman
C. Gordon Bell
Harvey D. Cragon
Robert Everett
C. Lester Hogan
Theodore G. Johnson
Andrew Knowles III
John Lacey
Patrick McGovern
George Michael
William Millard
Robert Noyce
Brian Randell
Kitty Seifridge
Michael Spock
Erwin Tomash
Paul Tsongas
Maurice Wilkes

Executive Committee

David Donaldson,
Chairman
Joseph F. Cashen
Gardner Hendrie
James McKenney
Nicholas Pettinella
John William Poduska, Sr.
Jonathan Rotenberg
Edward Schwartz
Paul Severino

Operating Grants

Corporate Membership

Sustainer—Over \$10,000

Digital Equipment Corp.
Hewlett-Packard
IBM
Massachusetts Council
for the Arts and
Humanities
Sequent Computer Corp.
Sun Microsystems
Symbolics, Inc.

Benefactor—\$10,000

Aetna Life & Casualty
Kurzweil Music Systems
MASSCOMP
NEC Corporation
PC's Limited
Raytheon Company
Tandy/Radio Shack Corp.
Xerox Corporation

Patron—\$3,000

Amdahl Corporation
Apple Computer
BankLink, Inc.
Boris Color Labs, Inc.
Coopers & Lybrand
DECUS
Denitsu, Inc.
Draper Laboratories
Fenwick Partners
Gaston Snow & Ely
Bartlett
Gourmet Caterers, Inc.
Honeywell
Manufacturers Hanover
Maxell Corp. of America
McGraw-Hill, Inc.
Phoenix Technologies
Prime Computer, Inc.
Raster Technologies
Ropes & Gray
The Travelers Companies
UNISYS
Zenith Data Corporation

Contributor—\$1,000

Adage, Inc.
Adelle Corp.
Analog Devices, Inc.
Analogic Corporation
Arthur Andersen, Inc.
Arthur D. Little, Inc.
Bank of Boston
Bank of New England
BASF
Baybanks
Bell Beranek & Newman
Boston Consulting Group
Boston Sale Deposit
Cincom Systems
Cognition, Inc.
Dane, Fair, Stone & Co.
Data Architects, Inc.
Data Translation
Deloitte Haskins & Sells
Dragon Systems
Easotech Management
E.I. DuPont de
Nemours Co.
E.M.C. Corporation
Executours, Inc.
Festive Foods Caterers
Foley Hoag & Elliot
Gilletto Company
Gratik Communications
Ltd.
Goldman, Sachs & Co.
GTE Laboratories, Inc.
Hub Mail Advertising
Hyams Trust
Index Technology
Informart
Intel Corporation
Interface Group
MediVision, Inc.
Mentor Graphics
Merrill Pichard Anderson
& Eyre
MICOM-Interlan, Inc.
Microcam
Micro Control Systems
National Semiconductor
NYNEX Service Company
Orchard Computer
Palmer & Dodge
Pect, Marwick & Main
Pell, Rudman & Co., Inc.
Phase3 Systems
Russell Reynolds
Associates
Schubert Associates
Sintex America
Shawmut Corporation
Sterling Hager
Teknowledge
Telechronics
Teradyne
Testa, Hurwitz & Thibault
USIR
VM Software
XRE Corporation

Contributing Members

Donor—\$500 or more

Andover Public Library
Anonymous
Roland Arndt
Burlington Public Library
David Culler
James B. Deadenack
Nick De Wolf
Ray Duncan
Branko Getovac
Tom and Rosemarie Hall
Martin Kirkpatrick
Alex Koller
Raymond Kurzweil
Andrew Lavin
Thomas Marill
Milton Public Library
Christopher Morgan
Linda J. Phillips
Paul R. Pierce
Audrey Reith
Ann Roe-Hofer
O. & K. Seifridge
Sharon Public Library
Thomas F. Stephenson
Seth Stern
William Steul

Sponsor—\$250

Timothy Anderson
Isaac Auerbach
Dorwin R. Belski
Robert M. Praetorius
Jordan Baruch
Graham Beauchamp
G. C. Belden, Jr.
James Bell
Leo Beranek
Gordon S. Brown
Peter Capek
Richard J. Clayton
Richard Corben
Phil Dorn
Dick Dunnington
Lucian J. Endicott
Bob O. Evans
Andrew Feit
Larry Forte
Philip Fox
Henry Fuchs
Kevin and Judith Galvin
Walter Garmble
John Gilmore
Roberto Guatelli
M. Ernest Huber
J. Milton Hutson
W. Richard Johnson
Bob King
Sheldon Larube
Paul Leach
Eli Lipson
Carl Machover
Andrew H. Mason
Tron McConnell
Joseph M. Newcomer
Anthony Oettinger
James V. Patton
PCK Technology Division
James N. Porter
Linda & David Rodgers
Michael J. Sarnak
John J. Shields III
John V. Terrey
Warren G. Tisdale
Michael Tomasic
G. Michael Usher
Christian Walker
Allan L. Wallack
S.W. Welch
Andrew Wilson

Friend—\$100

Kenneth R. Adcock
R. J. Alexander
Professor Arvind
Robert Z. Bachrach
Richard G. Bahr
Mario Barbaodi
Steve F. Barneby
John C. Barstow
Alfred M. Bertocchi
Lois J. Bizak
Bontronics
Daniel S. Brinklin
Robert E. Briney
Fred & Nancy Brooks
Les Brown
Brown University
Erik Bruhn
Gerald A. Bujancius
Roger M. Buey
W. Carlsson
Maria L. Carr
George Chamberlain
George Champine
Julio Christianson
Joel Clinkenbeard
James F. Cody
Howard I. Cohen
Michael J. Coppolino
Howard E. Cox, Jr.
Ronald Creamer
Michael Cronin
James Cudmore
Paul Curran
Randall Davis
Donald R. Daykin
Harvey Deitel
Delta Management
F. Demeo
Kevin W. Dick
Lucien Dimino
Ditarqami Family
Patrick M. Donini

Michel Doreau
Theodora Drapos
R. DuVal
Esther Dyson
Joseph J. Eachus
Richard J. Eckhouse and
Ruth Maulucci
William T. Elliott
P. J. Evans
Neil Farnam
Andrew Farber
Geoffrey Feldman and
Sharon Lipp
Harold Fitch
Robert France & Ruth
Doan
J. Thomas Franklin
Clark Frazier
Daniel Freedman
Alan E. Frstie
Bruce Gee
Bruce Galchust
Roger Galovsky
Steven Gold
Edward Gordon
Roger H. Groun
Kenneth Grammann
William Graustein
Paul C. Guglietta
Karl Guttag
Jerrier A. Haddad
J. Scott Hamilton
Keith W. Hare
James S. Harrison
Frank E. Heart
Paulyn Heunmiller
Ted Hess
Graec M. Hopper
Nancy S. Horie
Robert Ingham
Roy C. Johnson
Charles A. Jortberg
JSI, Inc.
Richard M. Karoff
Paul Katz
Gary Kessler
Bryan S. Kocher
Mark Koretz
Neal Koss
Alan and Judith Kotok
Seglindie Kress
Stanley Kugell
Robert Laman
Curtis Larock
Tsvi Lavi
Grace Leahy
Margaret L. Leiby
John R. Levine

Capital Campaign

64K or more

Apollo Computer, Inc.
C. Gordon Bell
Control Data Corporation
Cullinet Software, Inc.
Data General
Gardner Hendrie
Mitchell Kapor
Carver Mead
Kenneth Olsen
John William Poduska, Sr.
Wang Laboratories

32K or more

American Telephone &
Telegraph
Bank of America
Henry Burkhardt
ComputerLand
Kenneth Fisher
International Data Group
Burge Jamieson
Mitre Corporation
Russell Nofstker
Robert Noyce
Robert M. Metcalfe
Fontaine K. Richardson

16K or more

American Management
Systems
Anonymous
Clark Baker
The Boston Globe
Howard Cannon
David Donaldson
Doug Drane
David K. Dyer
Bruce Edwards
Index Systems
August Klein
Thomas Knight
James L. McKenney
NEC Corporation
David & Pat Nelson
Paul & Katherine Severino
Ron Smart
William Spencer
Charles E. Spork
Ivan Suberland
System One
Chris Terman
Minoru Tani
Stephen Watson
Daniel Weinreb

John V. Levy
Joseph L. Levy
John D.C. Little
Reed Little
George Logemann
Carl D. Lowenstein
Arthur Luehrmann
Edwin Mallock
Julius Marcus
Barry Marcolin
Melvin J. Mason
Richard O. Mason
byl Masquelier
Slevadson Massey
Peter Masters
Robert Mayer, Jr.
Richard McCuskey
Robert McCormick
F. Warren McFarlan
Douglas McKenna
William McLean
Todd Meelock
James Meschan
R. W. Meister
Barry Merrill
Jeanette Mirdoux
Charles Mirler
MOCO, Inc.
Allen Moulton
Rayman Mustafa
Isaac R. Nassi
Steven Nevins
London Noll
Bernard J. Nordmann
H. Edward Nyce
Thomas P. Oberst
James N. O'Boyle, Jr.
Martin O'Donnell
Lawrence & Pauline Oliva
Robert Ornes
Leon M. Padell
Joseph A. Pallone
Kenneth D. Patterson
George Peo
Frankie W. Peterson
James H. Philip
Michael Pique
Michael Pise
John Poppen
John H. Porter
David Potter
Richard Powell
John F. Pries
Brendan Reilly
Steven Reilly
Nicholas Reinhardt
C.M. Riggie

8K or more

AFIPS
Harlan E. & Lois Anderson
Erin & Renee Bloch
Winston R. Hinkle, Jr.
Theodore & Ruth Johnson
John Allen Jones
Stan Olsen
Russell Plamitzer
Doug Ross
Grant & Dorit Saviers
Edward Schwartz
Software Results Corp.
Erwin Tomash
Xerox Foundation

4K or more

Charles & Connie
Bachman
Gene Brewer
Roger and Mary Gady
R. Steve Chehey
Robert & Eleanor Chunn
Pat Clark
Robert G. Claussen
William Congleton
Alex d'Arbeloff
Arnaud de Vitry
Robert Everett
Ford Motor Company
Jay W. Forrester
William Foster
General Systems Group
Gaston Snow & Ely
Bartlett
Peter Hirschberg
Houghton Mifflin
Company
ICL
Jeffrey Kalb
Ailan Kent
Jack S. Kilby
Andrew C. Knowles III

Thomas S. Roy II
Stephen Russell
Sobaku Corporation
Howard Salwen
Michael Sarnak
Michael Sand
Robert Santy
Robert Schapp, Jr.
Stanley Schultz
Benesh Schwartz
Andrew Scott
Curtis A. Scott
Ronald F. Shea
Philip Shearer
Aaron Seidman
R. & M. Shamel
W. Lee Shevel
Dan Siewiorek
Diane J. Skiba
Charles Skoldfield
Phil Slaughter
Allen G. Sweider
Genia Steinback
Max J. Steinmann
Jack Stevens
Bruce G. Stewart
Hugh W. Stewart
Robert and Diane Stewart
J. Michael Storie
Charles A. Stott
Paul Sullivan
Steve Swerling
David Tarabai
John Tartar
Paul Tedesco
Michael Thompson
William R. Thompson
Diane Tobin-Hall
H. Dean Toornis
Robert Trudel
Noah E. VanDenburgh
Thomas Vaughn
Charles Volkstorf
Christian Walker
David P. Wheatland
John D. Wick
Hugh Williamson III
James Williams
Kevin Willoughby
Roy Wilson
Richard T. Witke
Frederic G. Withington
William A. Wulf
D. L. Yuchm
Leo Yochim
Hermann Zapf

David J. A. Koogler
Edward and Debbie
Kramer
John W. and Edna W.
Lacey
Liberty Mutual Insurance
Company
Raiph and Linda Lin-
salata
Robert Lucky
John Norris Maguire
Richard D. Mailley
Thomas and Marian
Manil
Daniel D. McCracken
Thomas and Elizabeth
McWilliams
Meditech
Allen Michels
Microsoft
Robert M. Morrill
Laura & Ken Morse
New York Air, Inc.
Nolan Norton Company
John L. Payne
Nicholas A. Pettinella
Edward G. Perkins
Robert M. Price
Regis McKenna, Inc.
Ben Robelen
Jean E. Sammet
Sequent Computer
Systems Corp.
Hal Shear
Alan F. Shugart
Richard L. Siles
Status Computer Corp.
Del Thomaide and Steve
Teicher
3Com Corporation
Jean De Valpine
Charles & Angela Wate
Harvey W. Wiggins, Jr.
William Wolfson

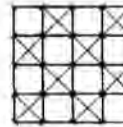

**The Computer Museum
Museum Wharf
300 Congress Street
Boston, MA 02210**

Joint Collecting Agreement

W

e have signed a collaborative agreement with the Smithsonian Institution, National Museum of American History, which promises to enhance the computing collections of both institutions.

"This is the first such formal joint collecting agreement the Smithsonian has made with a museum of the stature of The Computer Museum," said Dr. Arthur Molella, chairman of the Department of the History of Science and Technology, of the Smithsonian's National Museum of American History and a member of The Computer Museum's Board of Directors. He further explained, "The field is so large and there is so much to do that it's necessary for us to make agreements in important collecting fields with the leading specialized museums."

The joint arrangement with the Division of Computers, Information, and Society of the National Museum of American History is broad in scope, affecting historical research, preservation and exhibitry. We will cooperate in creating a common catalog and database of our collections. This is being carried out by a group composed of David Allison and Jon Eklund from the National Museum of American History and Gwen Bell and Lynn Hall from The Computer Museum.

The common goal in our collecting agreement is to make sure that all the important artifacts are preserved. Considering that computers are now entering their fifth generation and that the classes range from supercomputers to personal computers, the amount of material worth saving is growing. Cooperative collecting is essential for preservation.

The Scientific Instrument Commission of the Union Internationale d'Histoire et de Philosophie des Sciences is also cooperating in the effort to develop a complete listing of computer artifacts held around the world. While the collection of The Computer Museum

is international, many national and specialized museums preserve many significant machines from their regions. For example, The Science Museum, Kensington, has much of the known Babbage equipment and The Deutsches Museum, Munich, has a collection of the machines built by Konrad Zuse. The Computer Museum is proud to have the NEAC 2201, one of the first transistorized computers in Japan built by NEC, components of EDSAC, Maurice Wilkes' Cambridge University computer that is the first fully operational stored program machine, and other non-U.S. computers. One of the goals of The Computer Museum is to show that computer innovations are not unique to one country, to one company, or to any one institution.

Saving the history does not just mean collecting artifacts. For each artifact, a technical file is also needed. Such material includes manuals, notebooks, photographs, and other accounts of the development and use of the machine.

This report lists new acquisitions to the collections of the Museum. The listing illustrates the diversity of the collection. We have chosen to feature some ephemera on the cover, because this material is often thrown out or thought to have little value. On the contrary, ephemera are important because they can quickly evoke the spirit of an era. Don't throw out your memorabilia. Send it to us. Do it all at once, or one at a time. Several times a year, we receive a small envelope from Phil Dorn — it always has a surprise spec card from an early computer or some other piece of ephemera. When Lynn Hall, the registrar and I open it, we generally smile the rest of the day. You too can make our days happy.

Gwen Bell
Founding President

Table of Contents

Cover: *A random sampling from the Museum's collection of ephemera provided from the desk drawers, basements, and attics of Richard Beers, Gordon Bell, David Corbishly, Phil Dorn, Jack Edmonton, and John D. Recob. Photo: Jerry Rabinowitz*

The Collection 2

The Future of Personal Computing 8

Jean-Louis Gassée

The Early History of LEO 12

John M.M. Pinkerton

The Collection

New acquisitions from September 1985 through September 1987. Personal computers acquired between September 1985 and August 1986 are listed in Volume 17. Prior acquisitions are listed in Volumes 1, 5 and 10.

Computers

Applikon Graphics Systems
Model 701 (X785.86)
Gift of AT & T Network Systems

Atari, Inc.
2600 Original Development System (X725.86)
Gift of Ronald E. Milner

BMC International
i800 Model 20/20H (X807.87)
Gift of Roy Gibbon

Control Data Corporation
CDC 1604 (X859.87)
Gift of Jim Payne

Convergent Technologies
WorkSlate (X839.87)
Gift of Allen Michels

Data General Corporation
MPT 87 Computer (X633.85)
Gift of Data General Corporation

Electronics Associates, Inc.
EAI 16-31R (X806.87)
Gift of Tom Alexander

Electronics Associates, Inc.
EAI 580 Analog/Hybrid Computing System (X661.86)
Gift of Foxboro Company

Electronics Associates, Inc.
EAI TR-20 (X790.86)
Gift of S. J. Levanti

Heath Company
Heathkit EC-1 Analog Educational Computer (X735.86)
Gift of David J. Pedersen

Heathkit
H-1 Educational Computer (X799.86)
Gift of John Fitzpatrick

International Business Machines Corporation
6/442 Office System (X670.86)
Gift of Matrix Corporation

Intel Corporation
MCS-4 System (X651.86)
Gift of Joshua Horwitz

Intel Corporation
Intellic 800 Microcomputer Development System (X624.85)
Gift of Intel Corporation

Interact Electronics
16K Microcomputer (X778.86)
Gift of Russell O. Wheeler

Jupiter Cabltab Ltd.
Ace Computer (X773.86)
Gift of Donald A. Gaubatz

Melard Technologies
Access Portable Computer (X777.86)
Gift of Melard Technologies, Inc.

MIT Artificial Intelligence Laboratory
CADR (X842.87)
Gift of MIT Artificial Intelligence Laboratory

MIT Lincoln Laboratory
LINC (X834.87), (X835.87)
Gift of Michigan State University

Multitech Industrial Corporation
Model MPP-II Micro-Professor Home Computer (X626.85)
Gift of Clive Bolton

National Cash Register
NCR 299 (X781.86)
Gift of Glier's Meats Inc.

NEC Corporation
NEAC 2203 (X800.86)
Gift of NEC Corporation

Prime Computer, Inc.
Model 300 (X840.87)
Gift of Prime Computer Corporation

Research Machines, Ltd.
380Z (X810.87)
Gift of Research Machines Ltd.

Scientific Data Systems
SDS 940 Computer (X630.85)
Gift of Systems Concepts, Inc.

Synertek Systems Corporation
SYM-1 (X804.87)
Gift of Robert Perlestein

Xerox Corporation
Alto II (X749.86)
Gift of Xerox Corporation

Subassemblies and Components

Atari, Inc.
PONG Game Board (X833.87)
Gift of Alan Rifkin

Data General Corporation
MicroNOVA CPU Unit (X634.85)
Gift of Data General Corporation

Digital Equipment Corporation
Pre-PDP-1 Circuit Boards (X760.86 A-N)
Gift of David Spicer

Digital Equipment Corporation
VAX 785 Processor Board (X759.86)
Gift of Digital Equipment Corporation

General Electric Company
GE-235 Bay and Console (X798.86)
Gift of Harry David

International Business Machines Corporation
IBM 7094 Console (X837.87)
Gift of George Sadowsky

Lewyt
Printed Circuit Boards (CM-100 and CM-559) (X825.87)
Gift of Meshna Electronics

MIT Artificial Intelligence Laboratory
CONS Machine Wire-Wrapped Backplane (X841.87)
Gift of MIT Artificial Intelligence Laboratory

Remington Rand
UNIVAC I Boards (X828.87)
Gift of John D. Recob

Remington Rand
UNIVAC 1200 Series Modules (X797.86)
Gift of Joel M. Goldberg

Sylvania Electric Products, Inc.
Semiconductor Diode (X812.87)

Power Transistor (X813.87)
Gift of Frank Flynn

Memories

Digital Equipment Corp.
PDP-8 Core Memory (X793.86)
Gift of Stanley Reich

Electromagnetic Memories, Inc.
Core Memory Unit (X652.86)
Gift of Ralph Graves

Honeywell, Inc.
Datamatic 1000 Magnetic Tape (X660.86)
Gift of Honeywell Information Systems

International Business Machines Corporation
Disc Drive (X758.86)
Gift of Thomas Zucker-Scharf

International Business Machines Corporation
IBM 1360 Photodigital Storage System (X789.86)
Gift of Lawrence Berkeley Laboratory



Electronic Memories, Inc.
Core Stack Module (X647.85)
Gift of Boudreau Computer Services

Fabri-Tek, Inc.
Core Memory Module (X646.85)
Gift of Boudreau Computer Services

Fabri-Tek, Inc.
Fabri-Tek Core Memory Stack (X632.85)
Gift of Systems Concepts, Inc.

Ferroxcube Corporation of America
DDP 116 Core Memory Stack (X645.85)
Gift of Boudreau Computer Services

Ferroxcube Corporation of America
Core Memory Stack (X631.85)
Gift of Systems Concepts, Inc.

CDC 1604, 1960.
The 1604 was CDC's first mainframe computer. Designed by a team led by Seymour Cray, it had a 48-bit word and the purchase price with 32K of core memory was \$990,000. It used paper tape input and output that operated at 350 characters per second. In addition, four magnetic tape subsystems were available for \$145,000 each. By 1961, CDC produced one 1604 each month.

The first system was installed at The Naval Postgraduate School, Monterey, California. It was used for weather prediction, simulation, data processing, and games (for business, industry, and the military).

The Computer Museum acquired a complete 1604 that had been in service at the University of Illinois. When it was shut down, Jim Payne, one of its operators, saved the machine in working order. He put it in his parents home and dreamed of bringing the 1604 back to life as his retirement project. When this became unfeasible, Jim called us to come to his rescue and save the last known 1604. About the same time we heard of a museum project underway at Cray Research in Chippewa Falls, Wisconsin. We accepted the computer and immediately loaned it to Cray Research. It plans move along a complete, operable CDC 1604 will be on exhibit in Chippewa Falls.

International Business Machines Corporation, 2135 Disc Cartridge (X761.86)
Gift of Northgate Construction Company, Inc.

Lytton Industries, Core Stack (X644.85)
Gift of Boudreau Computer Services

National Bureau of Standards, SWAC Williams Tube (X625.85)
Gift of Jerry Mendelson

Raytheon Company, Biax Nanolok Core Memory (X635.85)
Gift of James Sutherland

Remington Rand, UNIVAC Core Memory Board (X826.87)
Gift of Meshna Electronics

Remington Rand, UNIVAC Magnetic Tapes (X831.87)
Gift of John D. Recob

Remington Rand, UNIVAC 9300 Plated Wire Memory (X784.86)
Gift of Vanguard Recording Society, Inc.

Vermont Research, Drum Unit (X786.86)
Gift of Carl Mikkelsen

Vermont Research, Model 1045 Drum Unit (X788.86)
Gift of Robert Kershaw

Unknown, Magnetic Shift Registers (X801.86)
Gift of Charles Crocker

Unknown, Prototype Core Memory System (X827.87)
Gift of Meshna Electronics

Unknown, Rope Memory Board (X830.87)
Gift of John D. Recob

Calculating Devices

American Can Company, American Adding Machine (X619.85)
Gift of Mr. and Mrs. Charles Collazzo

Bowmar Instrument Corporation, Model No. 90505 (X753.86)
Crag Model 4501A (X754.86)
Gift of Bowmar Instrument Corporation

Brunsviga Maschinenwerke Gimm, Natalis & Company, Brunsviga 20 (X762.86)
Gift of Murlan S. Corrington

Burroughs Corporation, Visible Adding and Listing Machine (X671.86)
Gift of Charles Sumner, Inc.

Commodore Business Machines, Inc., 1121 Calculator (X663.86)
Gift of Baynes Electric Supply Company

Curta, Curta Calculator (X816.87)
Gift of David Thorndike

Friden Corporation, Model 130 Calculator (X732.86)
Model 132 Calculator (X733.86)
Gift of James Patton

Hewlett-Packard Company, HP-12C (X768.86), HP-41C (X769.86), HP-71B (X770.86), HP-35 (X771.86), HP-28C (X805.87)
Gift of Hewlett Packard

Hewlett-Packard Company, HP-65 (X752.86)
Gift of Darwin Smith

Hewlett-Packard Company, HP-25 (X736.86)
Gift of William Herman

International Business Machines Corporation, Hexadecimal Adder (X803.87)
Gift of C F S Inc.

London Computer Corporation, Ltd., Model LC/509/S/1598 Computer (X650.86)
Gift of Gordon and Gwen Bell

Marchant Calculating Machine Company, Inc., The Marchant (X779.86)
Gift of A. Peter Hollis

Mini-Add, Inc., EXACTUS (X649.86)
Gift of Gordon and Gwen Bell

MIT RDA, #2 Differential Analyser Component (X838.87)
Gift of Richard W. Hamming

Monroe, 1860 Statistical Programmable Printing Calculator (X802.86)
Gift of Peter Livingston

Monroe, EPIC 2000 (X764.86)
Gift of Alan Chinnock

Monroe, Model 1665 Programmable Calculator (X765.86)
Gift of Richard S. Murdock

Monroe, Rotary Calculator (X796.86)
Gift of Charles H. Gushee

Norden, Bomb Sight (X809.87)
Gift of Mark Burnham and Steve Gamelin

North American Aviation, Inc., Nuclear Weapon Effects Probability of Destruction Calculator (X677.86)
Gift of David Martz

PERRYGRAF, Harvard Project Physics Multiplication/Division Circular Slide Rule (X621.85)
Gift of I.B. Cohen

Pickett & Eckel, Inc., Model N4T Vector Type LOG LOG Dual-Base Speed Rule (X659.86)
Gift of Rich Simon

Selectronics, Inc., PD-10 Personal Directory (X756.86)
Ultradial 120 (X757.86)
Gift of Selectronics, Inc.

Sharp, Elsi Mate EL-8130 (X766.86)
Gift of Gregory Welch

Sinclair Radionics, Ltd., Scientific Calculator Kit (X824.87)
Gift of Jim Kistler

Sinclair Radionics, Ltd., Sovereign Calculator (X654.86)
Gift of Brian Randall

Sony Corporation, SOBAX-2700 (X745.86)
Gift of Maccabees Mutual Life Insurance Company

Texas Instruments, TI Programmable 57 (X767.86)
Gift of Gregory Welch

The Lovelace Biomedical and Environmental Research Institute, Inc., Nuclear Bomb Effects Computer (X856.87)
Gift of Steve Golson

Triumphator-Werk, Triumphator (X776.86)
Gift of Victor H. Deutsch

Wang Industries, Inc., Electronic Calculator Model 320 (X815.87)
Gift of Joseph Sears

Unknown, Circular Slide Rules (X794.86), (X795.86)
Gift of Richard S. Murdock

Unknown, Saumatic Circular Slide Rule (X622.85)
Gift of I.B. Cohen

Transducers

Alphacom Inc., VP42 Printer (X774.86)
Gift of Thomas Restivo

American Automatic Typewriter Company, Model 6300 Auto-typist (X782.86)
Gift of Arnold J. Ustein

Anadex, Inc., Model DP-8000 Printer (X628.85)
Gift of Computerland, Inc.

AT & T Bell Laboratories, Prototype Nixie Tube (X672.86)
Gift of David Hagelbarger

Canon U.S.A., Inc., Laser Beam Printer LBP-10 (X857.87)
Gift of Canon U.S.A., Inc.

Centronics Data Computer Corporation, Model 730-1 Printer (X627.85)
Gift of Computerland, Inc.

Centronics Data Computer Corporation, Microprinter-S1 (X775.86)
Gift of Murray Melbin

Computone Systems, Inc., Keyfact Micro-VIP (X780.86)
Gift of Leonard M. Coris

Control Data Corporation, Programmed Film System (X664.86)
Gift of J. Stanley Hill

Digital Equipment Corporation, PDP-9 Scope (X783.86)
Gift of Donald Tufts

Friden, Justewriter (X811.87)
Gift of Wayne Thomsen

Hazeltine Corporation, 2000 Terminal (X668.86)
Gift of Carroll School For The Blind

International Business Machines Corporation, Port-A-Punch (X620.85)
Gift of Kirkland Olsen

International Communications Corporation, 40 + 10 Printer (X636.85)
Gift of Geoffrey B. Larkin

Kleinschmidt Division of Smith Corona Marchant, Teletypewriter TT 227/FG Reperforator/Transmitter-Distributor (X656.86)
Gift of Michael S. Drooker

Motorola, Inc., MDR Optical Card Reader (X737.86)
Gift of George P. Leyland

National Multiplex Corp., Digital Data Recorder Cartridge Drives (X738.86)
Gift of George P. Leyland

Owens Glass, University of Illinois Plato IV Terminal Plasma Display Panel (X676.86)
Gift of Joseph Cychosz

Rand Corporation, Prototype Videographics Terminal (X653.86)
Gift of Rand Corporation

Raytheon Company, DIDS-400 (X657.86)
Gift of David Ahl

Patent drawing for Prototype Nixie Tube, A T & T Bell Laboratories. The prototype Nixie Tube and the patent material were presented to the Museum by its inventor, David Hagelbarger. This is a glow discharge tube for displaying numbers. The tube contains an anode and ten cathodes shaped like the figures 0 to 9 inclusive. The tube is filled with gas and a glow discharge is initiated between the anode and cathode that is to be lighted. The glow occurs as a sheath which covers the cathode. A glowing figure at the back of a group of cathodes is not obscured by the unlighted ones in front of it.

The tube was conceived as an output for a computer. It permits any one of ten well-formed figures to appear in one place. Nixie tubes were used in some early computers and calculators, including the Anita, the first electronic calculator that is on display in the artifact Timeline on the fifth floor of the Museum.

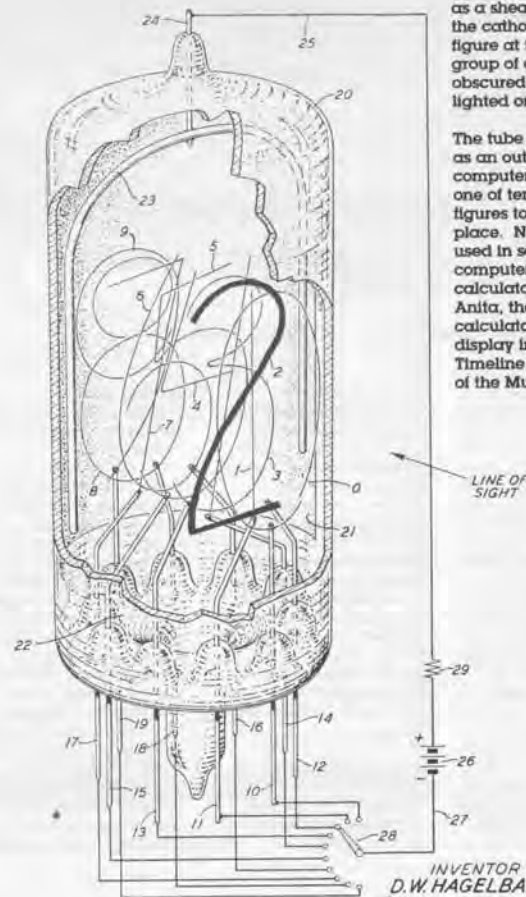

INVENTOR
D.W. HAGELBARGER
BY
Hugh S. Wertz
ATTORNEY

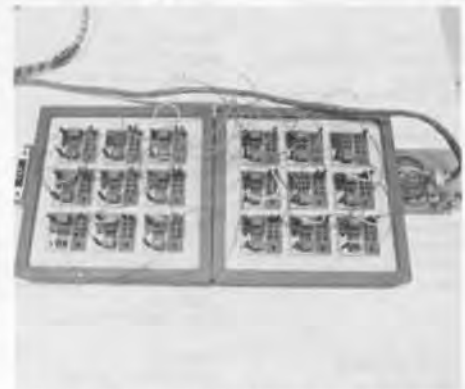
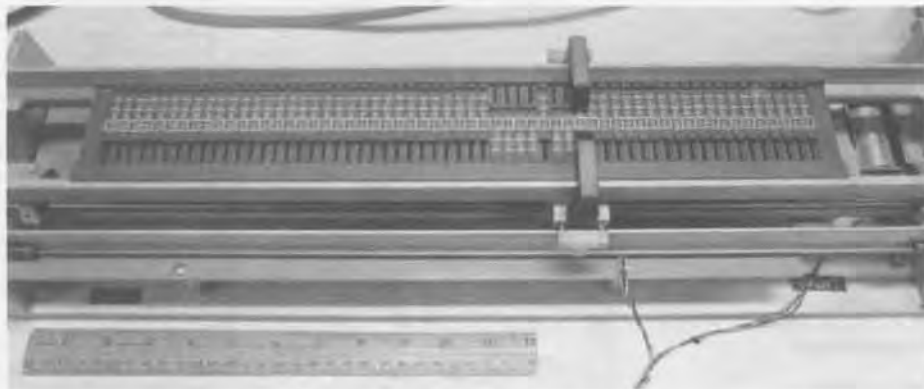

The Turing machine's "tape."

Patch panels representing up to eighteen states.

Turing Machine, by Wesley Clark and Robert Arzen, 1971

This Turing machine was a contribution to a workshop on educational kits sponsored by the IEEE. It was intended as an introduction to algorithms at the high school level. Professor Carver Mead subsequently used the machine to help teach an undergraduate computer science course at the California Institute of Technology.

The Turing machine is an abstract machine invented by Alan Turing in 1935 and described in his paper 'On Computable Numbers with

application to the Entscheidungsproblem.', Proc. Lond. Math. Soc. (2), 42 (1937). A Turing machine can be in one of a finite number of different states. The machine is equipped with an arbitrarily long tape containing symbols which the machine can read and alter one at a time. Each step taken by the machine is determined entirely by the machine's current state and the symbol just read. The options at each step are:

- change the symbol at the current tape position or leave it unchanged
- remain in the same state or change to

another state
- move a step left, right or stay in the same position on the tape.

Turing showed that such a machine, if provided with an appropriate set of states, could compute any number that can be arrived at by a definite, finite process. But he also demonstrated that there were numbers that his machine could never compute, even after an infinite amount of time. This was an example of an undecidable problem in the sense raised by the mathematician Hilbert. Hilbert's renowned 'Entscheidungsproblem' had asked whether, in principle, it was possible

to decide whether a mathematical assertion was true or false. The Turing machine showed that the answer was 'no.' In addition, Turing showed how such a machine was universal; it could, if provided with the appropriate table of states, simulate any other machine.

In this realization, the tape consists of 59 sliders each element of which can be in one of three positions: one, zero, or blank. The machine reads the tape by means of a pair of light beams and photodetectors and writes by moving the sliders with an electromagnet. The machine's

states are represented by the squares on patch panel boards; two boards offer up to 18 distinct states. The three outputs of the state (depending on whether the current tape value is 1, 0, or blank) are on the left. At each step, the machine transfers to the state connected to the activated output. Immediately to the right of each output is the corresponding program step for that state. This is implemented by plastic plugs of two types: arrows to move left or right on the tape and crossed arrows that flip the current tape value before moving. The inputs to the state are on

the right side of the state's square.

Students were set problems such as constructing a program that counts in binary using only two states. It takes just a few moments to implement a program using the pluggable wires and program step keys. To help with debugging, the machine can single step through a program. In run mode it executes at a rate of about one state a second. The machine endows its programs with a tangible reality; lights come on as each state is entered, and a loud click is heard whenever the tape is altered.

ix Systems, Inc.,
Rx Terminal (X662.86)
Gift of Herbert Teagler

Science Accessories Corporation,
Sonic Digitizer (X742.86)
Gift of George P. Leyland

Tabulating Machine Company,
Key Punch (X791.86)
Ventier (X792.86)
Gift of Stanley H. Richards, Jr.

Xerox Corporation,
Dover Laser Printer (X750.86)
Gift of Xerox Corporation

Robots

Carnegie Mellon University Robotics Institute,
Direct Drive Arm I (X822.87)
Gift of Carnegie Mellon University

Carnegie Mellon University Robotics Institute,
Pluto CMU Rover (X823.87)
Gift of Carnegie Mellon University Robotics Institute

Denning Mobile Robotics, Inc.,
Sentry (X819.87)
Gift of Denning Mobile Robotics, Inc.

General Motors, Materials from Consight-I Project, including Robot Arm, Conveyor Belt, and Structured Light Assembly (X820.87)
Gift of General Motors Research Laboratories

International Robomation/Intelligence,
IR3-M50 (X817.87)
Gift of Advanced Technology Systems

Johns Hopkins University, Adaptive Machines Group,
Beast (X821.87)
Gift of Johns Hopkins University

Naval Systems International, a joint venture of Deep Sea Systems and Benthos Inc.,
Sea Rover (X818.87)
Gift of Naval Systems International

Rehabilitation Institute of Pittsburgh,
Page Turning Robot (X844.87), Prototype (X843.87)
Gift of Rehabilitation Institute of Pittsburgh

Robotics Systems International Ltd.,
The Spider, from the movie, "Runaway" (X845.87)
Gift of Robotics Systems International Ltd.

Tomy Kyogo Company,
Omnibot 2000 (X846.87)
Gift of Raymond Industries

Miscellaneous Artifacts

AT & T Bell Laboratories, CARDIAC: A CARDBOARD Illustrative Aid to Computation, The Information Machine (X674.86)
Gift of David Hagelbarger

Bally Manufacturing Corporation,
Computer System (aka Bally Astrocade) (X726.86)
Gift of Michael Walter

Binary Arts Corporation,
Hexadectal Puzzle (X618.85)
Gift of Binary Arts Corporation

Cite Sciences of Industrie,
Smart Security/Credit Card (X617.85)
Gift of Gerard Courteux

Wesley Clark and Robert Arnszen,
Electro-mechanical Turing Machine (X641.85)
Gift of Carver Mead

Donald Lancaster,
Prototypes, Function Generator (X728.86),
Electronic Stopwatch (X729.86), Digital Voltmeter (X730.86), Pitch Reference (X731.86)
Gift of Donald Lancaster

Edu-Cards Corporation,
DIGI-COMP 1 (X638.85)
Gift of Jules Corn

Magnavox,
Odyssey (X808.87)
Gift of Tom Johnson

Natural MicroSystems Corporation,
WATSON, (648.85)
Gift of Natural MicroSystems Corporation

David Ahl, the creator and editor of Creative Computing, a magazine that he started in his garage in 1975, gave the Museum his entire collection of journals. It includes full sets of many of the smaller circulation and early specialized magazines that characterized the beginning of personal computing.

NCR,
PhotoChromic Micro-Image (X829.87)
Gift of John D. Recob

Oliver Audio Engineering,
OP-80A Paper Tape Reader, Data-Link, Inc.,
Paper Tape Splicer, Time Sharing Applications, Inc.,
Paper Tape Rewinder (X740.86 A-C)
Gift of Alan E. Frisbie

Oliver Garfield Company,
ENIAC Electric Brain Construction Kit (X734.86)
Gift of Theocleus M. Hershey

Oliver Garfield Company,
GENIAC (X836.87)
Gift of Elliot Linzer

Playskool, Inc., A Milton Bradley Company,
Play & Learn Computer (X741.86)
Gift of Michael Seidenman

Radio Shack,
Mathume Computer (X814.87)
Gift of G. Wilcox

Science Fair, Inc.,
Analog Computer (X744.86)
Gift of Steven A. Carpenter

Scientific Development Corporation,
Minivac 601 (X743.86)
Gift of John Van Deventer

Unisonic Products Corporation,
Tournament T102 Sportsman (X746.86)
Gift of Stanley M. Sinn

Wm. Schollhorn Company,
Punch Card Hole Puncher (X658.86)
Gift of Kevin Deame

Manuals, documentation, periodicals, references, proceedings, and books have been received from the following donors. Projects are underway to catalogue these items.

David H. Ahl
Stewart Alsop
Alex M. Andrew
Antics Enterprises
Artronics, Inc.
ASCI Corporation
Donald S. Berman
Microsoft, Inc.
Bitstream, Inc.
R. T. Bradshaw
Chris Burns
Margaret Butler
California Institute of Technology
Paul Genazz
Judith Clapp
Ernest B. Cohen
Roger Cole
Richard J. Conlan
Robert J. Cowen
Cranston/CSuri Productions, Inc.
Frank Crow
Dahner-Hayes, Inc.
Bill Dobson
Philip H. Dotn
Peter B. Dunckel
R. G. Dunn
Pat Edmunds
David M. Elowitz
Fabrice Florin
Boguslaw Frackiewicz
Alan I. Friedman
Dale Gagnon
General Motors Corp.
General Systems Group
Michael Gero
Ivan A. Getting
Gary Glazer
Richard Gough
Robert C. Gray
Paul Green
Sarah Greitz
GTE Data Services, Inc.
Honeywell Information Systems
International Computers Limited
Walter Johnson
Neil Karl
Christopher Kent
Nancy Killy
George P. Kuzara
Louise R. Ledest
Paul D. Lehman
Robert E. Machol
MAGI
Nelson Max
Donald McIlroy
Tim McNeill
Howard Mead
George Michael
MITRE Corporation in memory of David James
Phillip Mittelman
Manfred Mohr
Gregory E. Moore
Stephen Munier
National Decision Systems
P. D. Neuhauer and Jet Propulsion Laboratory
Omnibus Computer Graphics, Inc.
Pacific Data Images
George Pao
Powersharing Inc.
PPG Industries
David Price
Tony Pritchett
Raytheon Company
John D. Recob
Regis McKenna
John W. Rible
David J. Rondihone
Peter Rony
Stephen Russell
Ronald Sanecki
Peter S. Schay
Bent Schmidt-Nielsen
Angela B. Shillet
Richard Shuford
Thomas C. Teopien
Tektronix, Inc.
Charles W. Therman
Julian Thomas
Jon Titus
Uppsala University
Sweden
USS Massachusetts Memorial Committee
William H. Wallace
Washington University
David G. Whitmore
Marion Wilkes
Xerox PARC
Xerox PARC/CSI & ACM
Gregory Yob

\$1.50

dr. dobb's journal of
**COMPUTER
& Orthodontia**
Running Light Without Overbyte

November/December, 1976 Box E, Menlo Park CA 94025 Volume 1, Number 10

A REFERENCE JOURNAL FOR USERS OF HOME COMPUTERS

Consumer Action

Product & Software Testing to Become Regular Feature in <i>Dr. Dobb's Journal</i>	3
Unresponsiveness from Advanced Micro-Electronics, Stuart Falgout & DDI	4
SCOS Interface - A Status Report, Southern Calif. Computer Soc. Board of Directors	5
Thinking of Opening a Computer Store? Budget Estimates & a Map	10
Jim McCord Reports on the LSI-11, Jim McCord	11
Tariff Response, Compliments & Complainers	12
NEC & IMSAI Incompatible with 8080A, Letters from Glen Timney, IMSAI & NEC	14
Product Review: Puly 88 - AN EXCELLENT SYSTEM, Jof Raskin	16

Realizable Features

Multiple-Readable Programs & Tapes, Published in Magazine Format, Editors: DDI	6
Urean Acoustic Coupler to Read/Write Tape Cassette, Jim Warren	7

Software

It's a BASIC, It's an APL... It's CASUAL! Bob Van Votzah <i>A Homebrew Language & Interpreter from Chicago - Complete Documentation & Code</i>	19
NIBL -- Tiny Basic for National's SC/MP Kit, Mark Alexander <i>Complete Documentation & Fully Annotated Code Listings</i>	34
Updated CP/M Floppy Disk Operating System Now Available	51
Arithmetic Expression Evaluator Mod. Jim Ashbin	52
Dialogue on Design of TINY 10, Marty Bushann, Greg Townsend	54
6800 Monitor Relations, Comparison of MIBUG and MINIBUG II, Dennis Sutherland, et al.	56
Floating Point Notes	57
Assembler Coded Graphical Games on an Alphabetic Video Monitor, Marvin Winterreal	58
CHASE: A One or Two Player Video Game LIFE on an 8080 with a VDM	61

*Program Repository & Tape Duplication Facility, Community Computer Center
New PCC Periodical: The Computer Menu Journal*

... and dozens of other titles ...

Dr. Dobb's Journal of Computer Calisthenics & Orthodontia, November/December 1976. From the David Ahl Collection of Periodicals: 1975-1985



This is an early photograph of the EDVAC, the physical manifestation of the computer outlined in the "Draft Report" produced by John von Neumann in 1945. The plans for EDVAC were widely publicized and were the main topic of an influential series of lectures given at the Moore School in 1946. However, the original team of Prespert Eckert, John Mauchley, John von Neumann, Herman Goldstine and others broke up during the building of the EDVAC. This picture dates from about 1949, when it was completed at the Moore School of Electrical Engineering. It was delivered to the Ballistic Research Laboratory later that year. After further developments the EDVAC became operational in 1951 and continued in use until 1962.

Photograph of the EDVAC, University of Pennsylvania, donated by Sam Berman.

Software

Visicalc Software and "Software Arts Auction" notice, 87.67
Gift of Robert C. Gray

RECOMP II Computer Documentation and Punched Paper Tape Software, 86.40
Gift of Alan I. Friedman

Videotapes

ACM Conference on the History of Personal Workstations, 87.63
Gift of Xerox PARC/CSI and ACM

Antics Computer Graphics Demo '85, 85.43
Gift of Antics Enterprises

Argonne National Labs and University of Illinois films of Pioneer's Day, 86.43
Gift of Margaret Butler

Computer Cowboy, 85.36
Gift of Artronics, Inc.

Cranston/Csuri 1985 Demo Reel, 85.38
Gift of Cranston/Csuri Productions, Inc.

Hackers, 85.41
Gift of Fabrice Florin

Honeywell Spool Commercials, 85.42
Gift of Honeywell Information Systems

Inertial Confinement Fusion, 85.27
Gift of Nelson Max

Konrad Zuse Interview on NDR (German Television), 86.22
Gift of Paul Ceruzzi

MAGI Demo Reel 1985, 85.34
Gift of MAGI

MITRE MATHLAB (Carl Engelman), 86.42
Gift of Judith Clapp

Mockingbird A Musician's Amensuensis, 86.16
Gift of Xerox PARC

Omnibus Demo Reel, '85, 85.37
Gift of Omnibus Computer Graphics, Inc.

PDI Animation Assortment, 85.35
Gift of Pacific Data Images

Songs in the Language of Information. Installation of March 1985 Sarah Greitz Exhibition at MIT, 85.25
Gift of Sarah Greitz

The Mechanical Universe, 85.39
Gift of California Institute of Technology

Films

Computer Surface Generation by Ford Motors, Made on the IBM 704, 86.13
Gift of Walter Johnson

EDSAC, 86.31
Gift of Maurice Wilkes

First Magi-Synthavision Demo Reel, Computer Generated 1968-1970, Word Processing, 85.49
Gift of Phillip Mittelman

Flexipeed, 1967, 85.26
Gift of Tony Pritchett

Leo 1, The Automatic Office, 87.62
Gift of International Computers Limited

Project Mac, 87.64
Gift of Charles W. Therrien

UNIVAC Sales Presentation, 86.11
Gift of PPG Industries

Photographs

First GTE Computer Printed Telephone Bill (photocopy), 87.77
Gift of GTE Data Services, Inc.

Mariner IV Data (color negative), 87.69
Gift of P. D. Neuhauser and Jet Propulsion Laboratory

Martin Newell's Teapot Images, 87.61.
Gift of Frank Crow

EDVAC (3), 85.44
Gift of Donald S. Berman

National Computer Conference 1985 photographs from Pioneer Day Exhibit (approx. 175 photos)
Gift of Margaret Butler

Ephemera

Computer Buttons (X763.86)
Gift of David Cobbesley

ComputerWorld Button Collection (X858.87)
Gift of Jack Edmonton

CCC tielack (X847.87), DEP-316 Tile (X848.87), The Pulse, Framed Copies (X850.87)
Gift of Edward McManus

DEUCE Programmers Reference Card & 3 Punch Cards (X851.87)
Gift of Peter Clout

Honeywell Animal Poster, "Forget-Me-Not Computer Brochure, and Honeywell D1000 Computer Brochure (X852.87)
Gift of Honeywell Information Systems, Inc.

Honeywell Animals Playing Cards in Binary Notation (X853.87)
Gift of Roberto Canapa

John D. Recob Collection of Computer Ephemera (X832.87)
Gift of John D. Recob

OPM Bookmark (X854.87)
Gift of Philip H. Dorn

Temporary Pass for Admission to SAGE North Bay Canada Installation (X855.87)
Gift of David Scully

Treni, Inc., TREN I Mascot Computer and No-op Software Punch Card Consetti (X623.85)
Gift of Robert E. Youngberg

The Future of Personal Computers

Jean-Louis Gassée

Henri Bergson, in the early part of the twentieth century, stated: "Intelligence, in what seems to be its original feature, is the faculty of manufacturing artificial objects, especially tools for making tools." This is a very nice representation of personal computers long before they were created. But it shows that the computer, as a tool, has been desired for a long time.

This is only the beginning of the beginning. For all intents and purposes, what has happened until now can be dismissed. A couple of years ago, people questioned whether there were fewer technical innovations and the personal computer industry was slowing down. I don't even see that we are at the shoulder of a curve that is flattening out; we are about to enter a very rapid era of evolution.

What are personal computers today?

Personal computers are tools that will bring about a greater cultural change than Guttenberg, TV, or even air conditioning. The crux of the matter is that mankind has been in a long continuous developmental effort to make things that our brains don't do well. Our power of reasoning is very effective but not very efficient. We are great at seeing patterns — great at isomorphism — finding knobs and twisting them conceptually. But we can't do sums; we're miserable at arithmetic. While I'm a mathematician by trade, I have great difficulty in translating miles per gallon to liters per kilometer. I'm

frustrated by this because it's counter-intuitive and I have to switch measures and units. I get confused. That's why we lust for computers. We feel that we have brains that are not up to the tasks we need to do.

Personal computers are intellectual power tools. But what we need to do is to make the symbiosis between man and computer much better. Computers drill intellectual holes that we cannot drill with our own minds. They are simulating engines and new media. The electronic spreadsheet is a simulation of an existing environment with lines and

Mr. Gassée, Senior Vice President of Research and Development, Apple Computer, Inc., spoke at the Museum in May 1987. This is an edited transcription of his talk. The Computer Museum is responsible for any inaccuracies it may contain.

columns; it is an enriched electronic metaphor of an existing situation. On the other hand, each time the electronic metaphor is impoverished it doesn't work, such as most applications of "home computing" with the poor metaphor of the cookbook or checkbook.

Why is the personal computing simulation engine a good tool? The human being has a lot more power to implement design decisions using a personal computer, whether it is designing a memorandum on a good word processor, preparing slides with a great outliner or desk-top publishing program, or designing mechanical or electrical objects.

Personal computers are not large computers made smaller. For example, financial planning was done on mainframes long before the TRS-80 or VisiCalc. Information was fed into the computer, it crunched away, and later excreted the results. The TRS-80, Commodore 64, the Apple II, and VisiCalc marked the birth of personal computers for real people, not just for hackers. The difference between financial calculation on a mainframe and on VisiCalc is clear. On the personal computer everything happens right now. It is an interactive simulation; not input, processing, and then output.

The Short Term Future

Contrary to some past predictions, technology is accelerating. In the next five years, we will see greater improvements in silicon, magnetics, printing, and network devices (but not keyboards) than in the past five years. Since 1978, personal computers have cost \$5,000 and each generation has brought much more power. The next round will have much better, deeper graphic capabilities at this same cost. This phenomenon will continue into the future.

The short term will also see more players. Several years ago, the compression of the industry was predicted. But today, there are more semi-conductor companies, more software companies, and more vendors of all kinds. And, we haven't seen our friends from Japan in the marketplace yet. The only conclusion is that there will be more players and not less players.

be more compatible across vendor lines so that you won't have to worry about which brand of computer you use to develop your spreadsheet and which brand you use to create your graphics and printing.

It is important to have standards for the substrate of data and networks so that user-interfaces and computers can be diverse. The big fuel for growth will be invisible, heterogeneous networking.



Jean-Louis Gassée

Courtesy of Apple Computer

The Intermediate Future

Quantity begets nature; by this I mean that when the population grows, the use changes. It is not just the number of MIPS that are available, but how they are managed for the user. We hope to see rapid evolution of user interfaces.

The intermediate term change will be real networking. Today it is not affordable by most, and when it is used the user is too network conscious. The real purpose of a network is to disappear. It is a means to an end for shuttling data back and forth. The real change is that data will

Having a computer that has access to remote memory without going through protocols will make them more intelligent. This phenomenon will not occur in the short term because of the slow development of ISDN "Integrated Services Digital Network."

With networks you can have such a new product as an integrated network spreadsheet. For example, you can call in data to your spreadsheet from other computers on the system and other spreadsheets can be updated as information is changed. Peer-to-peer communication will create greater productivity.

The More Distant Future

Long term predictions also relate to interactive simulations. Imagine that you can sit in front of your computer and plan a trip to Italy. Today, you would have to get into Dow Jones or CompuServe and then into the Official Airline Guide and start muddling in schedules. It's painstaking and requires a lot of knowledge. Normal people cannot do it. And in this industry, we have to serve normal people, not people with lots of money or who like to "hack." Now let's imagine that you can invoke a map of Italy and point where you want to go. The computer proposes schedules, shows you pictures of hotels, museums, restaurants, beaches, and other places of interest so that you can simulate your trip. Try it conceptually and find out what it's going to cost. If it's too much, then you can try something different. And then when satisfied, make the reservations. It's not hard to imagine that you would like to do that.

Similarly, if you want to remodel your house, it would be nice if your computer knew a lot about its structure, the building codes, the wiring, etc. Then you could go through an aided-simulation of changing the family room so that you don't have to draw the plan. The computer does this and then follows through with costing, scheduling, and the other planning processes in remodeling.

Computers today, although we love them, are hopelessly underpowered. To do those kinds of simulations, our computers are several orders of magnitude underpowered. We need new ways to use the greater power that is very easy for us. We need A.I. and A.I., A.I., A.I. . . . in ways that I can't even specify today.

Today there are 10,000 data bases that are available. That is nice? Maybe? If I say "Honda Civic" to you, we share a common enough data base that we know what this means. We can have a meaningful dialogue about it. But I have no cognitive experience about what 10,000 data bases mean. It is hard enough to dial into Dialog. Most data bases are unusable. They require navigation tools. We can only hope that ISDN will be equalized networking technology to the home and the office. We need real door handles to make it useful for everyone. We still don't have the VisiCalc of data bases.

"Having a new language, we will have new thoughts."

Another longterm goal is to provide a symbiotic relationship between man and computer. People at MIT, Xerox PARC, and then Apple promoted the mouse. What is it? It is not meant to replace the keyboard; when you want to type text you type text. The mouse provides direct manipulation with the computer. For instance, instead of typing delete "such and such file," you simply grab the mouse and throw the file in the trash can. You do it directly. You don't have to know how to spell. You just do it.

Some ideas, derived from the devices to help the disabled use computers, take us beyond the mouse. There are prostheses that capture nervous system outputs

and convert them into simple computer commands. Neuro-physiologists have known that when we read we unconsciously send commands to the larynx. We don't speak out loud because we are told (after we learn to read) that we have to shut up. So we shut up, but the brain keeps sending the signals and we learn to control the impulse to speak, almost. Most people still do little jittery movements of the larynx as they read.

In the symbiosis between man and computer, the impulses in the nervous system can be decoded for direct manipulation of the computer without having to grab the mouse with our hand. This is technologically not necessarily any more difficult than understanding speech, especially in only controlling a small set of actions such as moving cursors and clicking mice. This is fallout from the work being done with fighter pilots for control in the cockpit. My dream is for gestural or neural input and graphic output. If you look at a neural physiological map of the neurons in the cortex you will find that the hand has the most territory.

McLuhan said, "Man forges tools and thereafter our tools shape us." This new medium, the computer, will create new thoughts. That sounds bizarre. If we have computers that communicate with the nervous system we will think, learn, and play differently. Having a new language, we will have new thoughts.

Computers today are exceedingly difficult to program. With new, more powerful machines, we will sacrifice a little of the new speed to have easier programming. Today the marketplace is screaming for user-controlled languages because people want control. People want power. Do you like to program your VCR? The coffee maker?

The Great Equalizer

My concerns for the future include the creation of the gulf between the computer haves and the have nots. The gap between the most and least educated persons in the Western world is widening. We are in great danger of creating an intellectual South Africa. The people with the best education end up with the most interesting, and highest paid jobs. The lack of symmetry is interesting: people who have boring jobs don't get paid more. The most exciting jobs are the best paid.

Apple's Role

Apple stands on the shoulders of giants. We adapt things; we don't invent many things. That's nice. There is nobility in making things nice and usable. Apple's role is to provide platforms for the creativity of other people. Seymour Cray is one of our customers and I'm proud to say he uses our machine to do some drafting. Our role is to integrate ideas and make them into products so that they can be on the shelves in the store for people to buy to enhance their pursuits.

We feel that social policy and long term marketing should be convergent. It should not be a tug of war. But the problem of declining literacy really scares me. If you can't spell, a spelling checker won't do much for you. No one knows how to fix the declining literacy in the Western world. One underlying reason is that technology is making the world easier to live in. The survival needs, just about the poverty level, are less than they used to be. TV is part of this, but it is legal and I don't believe in cultural fascism. VCR's and tapes are the wrong medium for learning. Learning is not pouring information into a vessel, the student. Learning is simulation. It is trying out pieces. Putting them together. Trying again. The reason that there are so few good learning programs on personal computers today is that good learning programs are simulation programs. They are impoverished metaphors of the book or of silly games.

“Learning is not just pouring information into a vessel, the student. Learning is simulation. It is trying out pieces. Putting them together. Trying again.”

The great equalizer of having networks in the home and office is going to happen in Europe and Japan before the United States. I don't like it because I want it. (I am a frustrated user.) But I am also frustrated because networks are an important tool for productivity for the whole country. In the US, freeways are built by the federal government. Similarly, I think data freeways should be an edict of the federal government. If this job is not done, the forces of the free market could create a time lag or some expensive incompatibilities that we, as customers, would end up paying for. The ISDN standard for graphic stations is a less attractive subset than the European standards.

While Apple will have a CD ROM device in the future, today's problem is to get two gigabytes of information out of the machine usefully. Experimentation is going on for new navigational devices. We will lick the navigational problem before the publishing problem. Why? We fantasize about using the computer to write. For my next book, I'd like a thesaurus, Strunk and White's *Elements of Style*, and some specialized materials. The data bases that can be on CD ROMs for a mass market are small. I think some vertical market areas may develop, such as tax rules. Nevertheless, Apple will provide a CD ROM product and lose money for a while.

We feel that the computer is the celebration of the human spirit. Holobart, another philosopher, said, "The cathedrals of the twentieth century are cars" because they reflect technology, art, and human freedom. I certainly hope that if Holobart were alive today he would say that computers are the cathedrals of the second half of the twentieth century.

The Early History of LEO: The First Data Processing Computer

John M.M. Pinkerton

John Pinkerton was the chief architect of LEO, which stood for Lyons Electronic Office. LEO, the world's first commercial data processing computer, is a direct descendant of the architecture outlined in draft EDVAC Report via the Maurice Wilkes' EDSAC. LEO I was being used for payroll and office data processing in early 1954, prior to similar use by GE of their UNIVAC 1.

John Pinkerton tells his own story, that of a young physics graduate of Cambridge, who joined The Lyons Company and was inspired by Comptrollers John R.M. Simmons (who died in 1985) and T. Raymond Thompson (who died in 1972) to build the first data processing computer. G.B.



Photo: Linda Holecamp

John M. M. Pinkerton and Gwen Bell at the talk. Pinkerton presented the Museum with a marketing film to sell LEO II computers that was made by Lyons in 1957.

The Lyons Company

How did it happen that J. Lyons & Company Limited, a wholesale food and catering business, came to build a computer for its own use and then go into the computer business?

In the 1890s, the Salmon and Gluckstein families started a business at Cadby Hall in West London to cater for functions at

the Olympian exhibition halls next door. By the beginning of World War II, Lyons had a high reputation for efficiency with the general public. They ran a variety of wholesale food businesses distributing tea and coffee, ice cream, bread and cakes, as well as other lines throughout the UK. Lyons did not believe in using wholesalers but sold and delivered directly to twenty or thirty thousand small

This is an abstract of a talk given by John Pinkerton at The Computer Museum on October 4, 1987. A paper on which this talk is based is copyrighted by John M.M. Pinkerton.

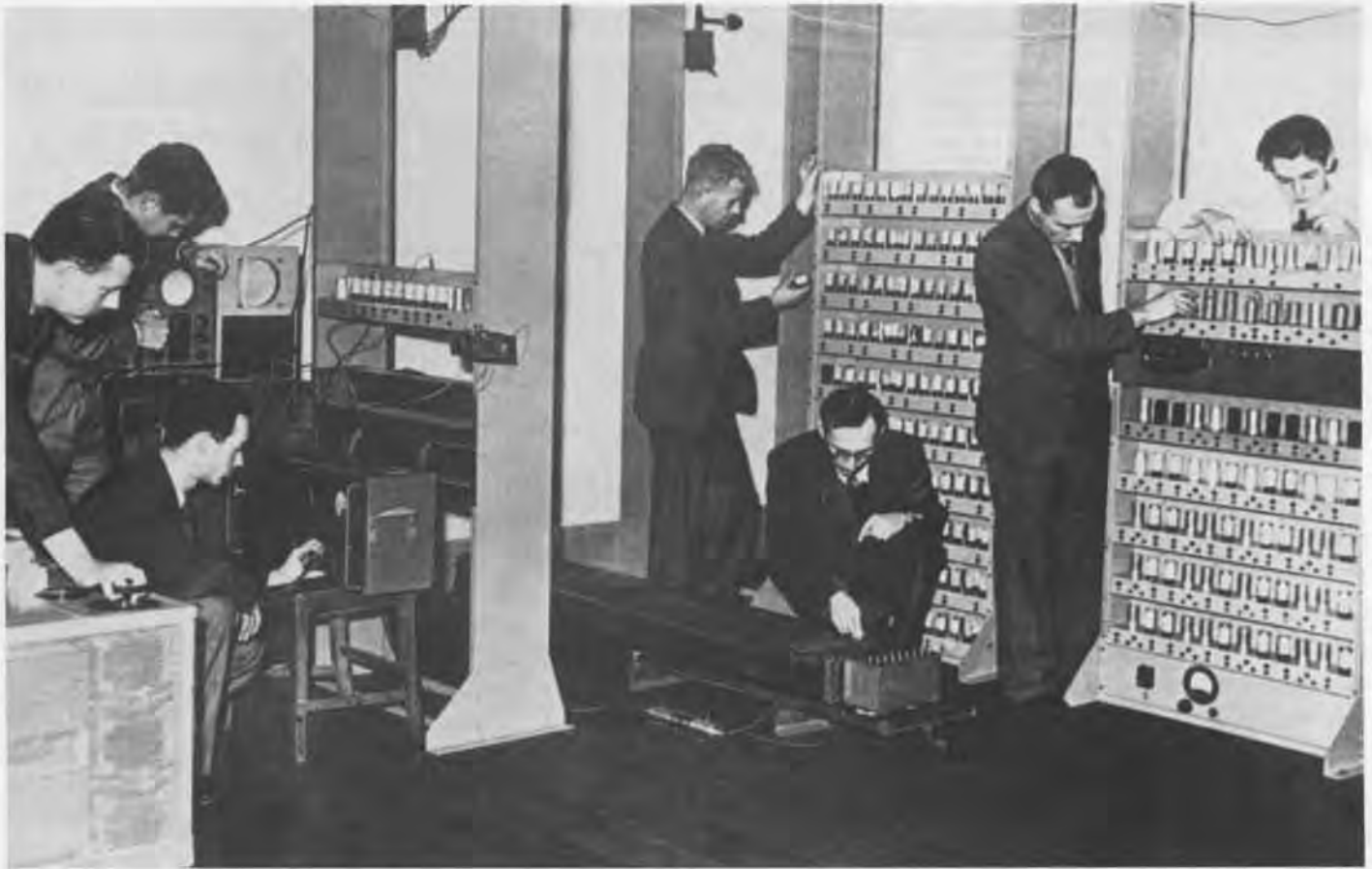

The EDSAC being built at Cambridge University Mathematical Laboratory. Maurice Wilkes is kneeling in the center behind the mercury delay lines.

retail shops. They also had a chain of about 150 tea shops, four or five large hotels, various restaurants, and an outdoor catering division. They employed 30,000 people. All this meant routine accounting for a vast number of small transactions with clerical efficiency since margins were small.

In the early twenties, the need for effective methods of accounting was recognised and resulted in the recruitment of a young mathematics graduate from Cambridge, John R. M. Simmons. A few years later he recruited another Cambridge mathematician, T. Raymond Thompson. By the mid-thirties they had rationalized the Lyons office practice and brought it under their management. In *LEO and the Managers* (1962), Simmons wrote, "...the

curse of routine clerical work is that without exercising the intellect, it demands accuracy and concentration. ... (He was) looking forward to the day when machines would be invented which would be capable of doing all this work automatically."

By the thirties, Simmons and Thompson were not only studying the accounting and calculating machines on the market but using some in intensively unorthodox ways. For instance, they were pioneers in the use of the Kodak Recordak camera for processing bakery orders. Punched card systems were not generally favored. Lyons believed that the rationalisation of clerical procedures that was needed to transfer work to cards would not prove to save costs.

When I joined Lyons in 1949, Simmons was Chief Comptroller and Thompson was Chief Assistant Comptroller. They were in charge of some 2,000 clerical staff who worked in large open plan rooms with 200 clerks carrying out routine payroll calculations, order processing or invoice passing. I found the atmosphere in the clerical department was one of high seriousness of purpose and dedicated loyalty on the part of the staff. Systematic grading of clerical jobs had been pioneered in Lyons' offices and rewards and promotion were strictly related to merit, which was regularly reviewed.

Simmons was totally dedicated to management and especially to the collection and application of management information using the computer. This came out



The LEO I used 5,000 valves (vacuum tubes), drew 30 kw of power of which 3 kw were used for cooling fans, and occupied a room 45 feet square. The mercury in the delay tubes weighed half a ton. It executed 700 instructions per second and could produce two-line papyrus at the rate of 50 per minute on the line printer.

The Birth of LEO

clearly in his second book: *The Management of Change* (1970).

Thompson joined Cadby Hall in 1928, after working in a Liverpool department store. He had the quickest intelligence of anyone I ever met. Much of the inspiration for the hardware development as well as the software of the LEO project came from him. He could quickly visualize ways to organize anything from a complex clerical task to a language compiler down to the finest detail. He maintained the enthusiasm and set the intellectual and management tone of the Leo project from its beginning in 1947 to the merger with English Electric in 1963.

In 1947, Lyons sent Thompson and Oliver Standingford to the USA to investigate the "giant brains" that were then being reported in the British press. An introduction was obtained to meet Professor Goldstine at Princeton who was associated with the ENIAC and specifying the EDVAC. I heard Thompson's account of this meeting several times. It apparently lasted an hour or so. In the first half hour, Goldstine explained to Thompson the principles of the stored program computer. In the second half hour, Thompson explained to Goldstine just how the computer could be employed on routine clerical work, such as payroll and invoicing.

Ironically in the USA, they learned about Maurice Wilkes' EDSAC project underway at

Cambridge University. They lost no time in going to Cambridge on returning to the UK. After seeing Wilkes' project, Thompson told me he was impressed by the squareness of the pulses he saw on an oscilloscope in the lab (even though he had no knowledge of electronics). Thompson and Standingford formed a favorable impression of Wilkes' work reported for the Lyons Board. Only a fragment of this has been preserved: "We believe that they have been able to get a glimpse of a development which will, in a few years time, have a profound effect on the way in which clerical work (at least) is performed. Here, for the first time there is a possibility of a machine which will be able to cope, at almost incredible speed, with any variation of clerical procedure, provided the condi-

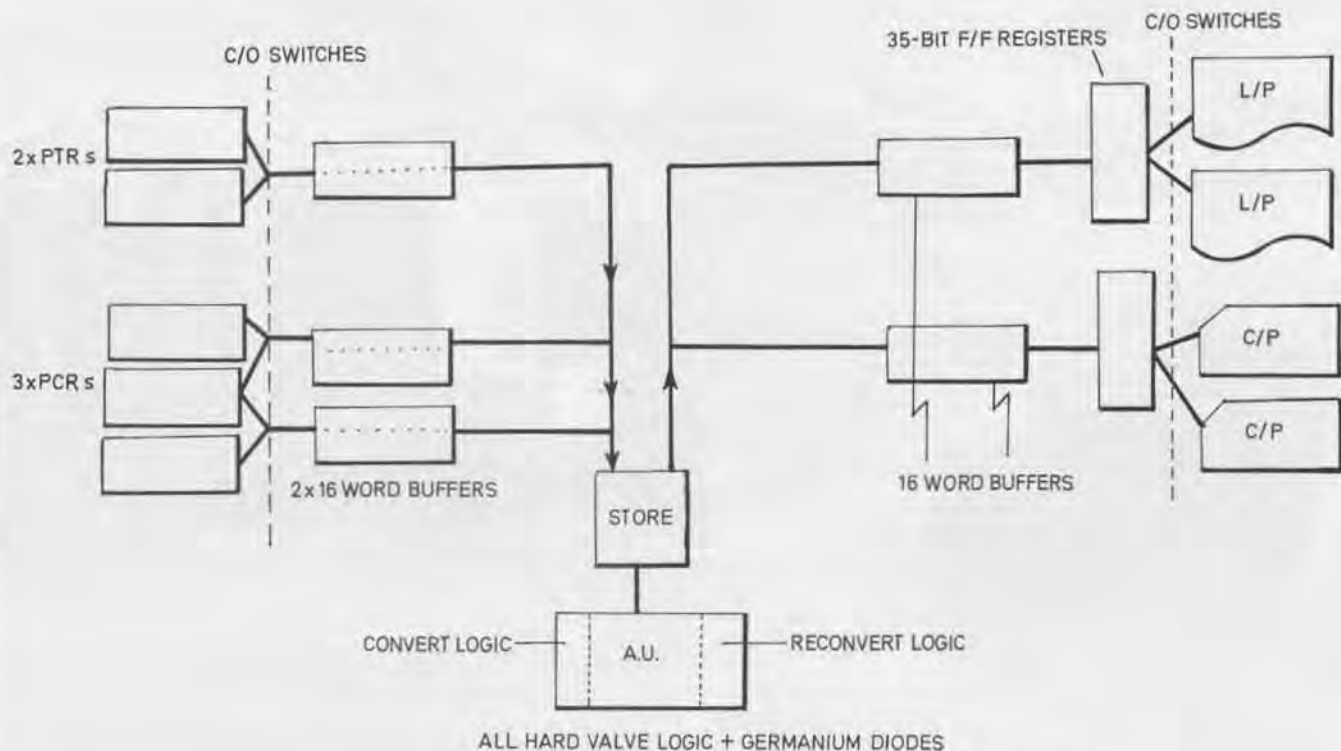

The overall organization of LEO I as it was built.

tions which govern the variations can be pre-determined. What effect such a machine could have on the semi-repetitive work of the office needs only the slightest effort of imagination. The possible saving from such a machine should be at least £50,000 a year. The capital cost would be of the order of £100,000.

"We feel therefore that the Company might well wish to take a lead in the development of the machine and, indeed, unless organizations such as ours, namely the potential users, are prepared to do so, the time at which they become commercially available may be unnecessarily postponed for many years."

In November 1947, the Board agreed to contribute £2,500 to the cost of the EDSAC and to lend Ernest Lencerts to Wilkes for six months, which turned out to be nearer a year. Lencerts, who had worked for Lyons for several

years, was employed in electronic engineering during his war service. In return, Wilkes agreed to give Lyons whatever details of the EDSAC design they might need to build a machine for their own use. Lencerts reported to Thompson on progress.

During 1948 Lyons tried, and failed, to find a contractor to build a machine like the EDSAC. Later that year they decided in principle that when Wilkes' machine had been shown to work, they would build a version of it themselves. They therefore advertised for someone to take charge of the engineering and I applied for the job.

When the anonymous advertisement appeared I suspected it was from Lyons. I had returned to Cambridge after the war to work with Mr J. A. Ratcliffe at the Cavendish Laboratory only 100 yards away from the Maths Lab where Wilkes worked. I wrote a thesis on ultrasonic absorption in

liquids using a pulse method which, as it happened, was an ideal preparation for work on computers using delay lines for storage. I first met Wilkes as an undergraduate through the University Wireless Society. In the summer of 1948, Wilkes told me about Lyons' interest in building a computer.

In December 1948, I went for an all day interview at Lyons which was extremely impressive. Not only was I given an excellent lunch, but Mr G. W. Booth, the venerable but alert Director of the clerical department who was over 80 years old, came out to interview me. He asked me if I thought I could make this machine work. I optimistically said I could, but added that as it needed several thousand valves, it would be difficult to make reliable, which naturally turned out to be correct. On December 18th, I got married and in mid January, 1949, I started to work for Lyons.

Construction of LEO 1

Lyons decided to wait to start building their copy of EDSAC after it was demonstrated to work by computing a table of primes. In the meantime, I went to a Lyons training course given to their office supervisors and spent several weeks in Cambridge absorbing the design of EDSAC and its logic and circuit techniques. Ernest Lenaerts and I set up a small workshop to build a delay line and circulate pulses in it. We also tried some ideas for transmitting pulses over long leads because we thought LEO would be physically bigger than EDSAC.

In February 1949, I started discussions on how to deal with the input and output problems revealed by the payroll program. It was recognized that input data would typically fall into one of three categories: (1) current data reflecting events since the last run of the job, (2) data brought forward from that run and (3) semi-permanent data not requiring to be repunched for each run. Similarly results would fall into at least two categories: (1) results to be printed and acted on (e.g., wages to be paid) and (2) results to be carried forward.

We decided that LEO needed multiple channels for both input and output, to be fitted with buffers that could be read in a single operation and were large enough to hold all the data items of a given kind, e.g., one person on the payroll. We also decided that LEO needed means for converting and reconvertng data and results automatically in each channel, rather than using sub-routines within the machine. The first of these decisions turned out to be excellent but the second was bad in execution and probably in principle.

Once EDSAC began to work, events moved fast at Cadby Hall. A large room in the office block was allocated, staff were transferred from other departments or hired from outside, and Lyons excellent drawing office got to work drawing up racks and chassis to carry the circuits. A contractor was appointed to build the units, and a revised design of the EDSAC batteries of ultrasonic delay lines was drawn up making full allowance for engineering tolerances.

Putting LEO to work

From the start Lyons believed that their own staff should create programs for LEO which would be suitable for the work of their offices. In 1950, David Caminer who had been in charge of Lyons Systems Research Office was appointed to take charge of all

Handmarked documents at J. Lyons & Company Ltd. to be automatically read and transferred to punched paper tape by LEO in the early sixties.

E/21 BAKERY RAILS ORDER FORM			
DEALER'S NAME		JOURNEY NUMBER	100 200 300 400 500 600 700 800 900 CALL DAY
			1 2 3 4 5 6 7 8 9 10 11 12
DEALER'S NUMBER		QUANTITY ORDERED	
		1 2 3 4 5 6 7 8 12 24 48 96	
1	KUP x3 Chocolate	ctn. 9d	
2	KAKES x3 Lemon	ctn. 9d	
3	x3 Orange	ctn. 9d	
4	COCONUT TOASTIES x3	ctn. 9d	
5	CHOC ROLLS x12 C.V.F. Jam	ctn. 3/-	
6	MILK CHOC ROLLS x12 C.V.F. Jam	ctn. 3/-	
7	COCONUT LAYER CAKES	ea. 2/3	
8	LARGE Raspberry	ea. 1/8	
9	SWISS ROLLS Apricot	ea. 1/8	
10	x6 Jam (Assorted Flavours)	ctn. 1/6	
11	TARTS x6 Lemon	ctn. 1/8	
12	x6 Almond	ctn. 1/9	
13	x6 Blackcurrant	.. 1/9	
14	x6 Treacle	.. 1/4	
15	INDIVIDUAL Apple	ea. 7d.	
16	Blackcurrant with Apple	ea. 7d.	
17	PIES Apricot	ea. 7d.	
18	Strawberry&Apple	ea. 7d.	
67	JUNIOR (CARTONS OF 4 JAM)	4/-	
68	JOLYROLS x4 (CARTONS OF 4 C.V.F.)	4/-	
69	NIPPY FANCIES x3 (BOXES OF 6)	6/-	
70	BARGATTO x3 White	5/3	
71	Chocolate		
72	Variable		
73			
74			
75			
76			
77			
DELIVERY REQUIRED		MONTH	1 2 3 4 5 6 7 8 9 10 11 12
		DAY	1 2 3 4 5 6 7 8 9 10 20 30

J. LYONS & COMPANY LTD. CADBY HALL, LONDON, W.14

LEO Lives On ...

LEO programming. Payroll was to be the first main routine task. Since a breakdown in the middle of a two hour job could be serious, the concept of putting out restart totals at the end of each department in the payroll was established early on.

Punched card machines were used for all channels, except those carrying current input data, for which we chose punched tape. Binary, not decimal numbers, were punched into the cards as a compact method of carrying forward results from one run of a job to form the data for the next.

We estimated that doing the conversions by subroutines would take up 90% of the time of LEO I. But the conversion and reconversion problems were solved when Lencerts recognised that if the binary values of 10, 100, 1,000 and so on were stored in a matrix of the new germanium diodes, then the control circuits for multiplication and division taken over from EDSAC could be adapted to control the two conversion operations. They took no more than 10% of LEO's time, an acceptable overhead. About 1,000 new germanium diodes were used, accomplishing a task that would have been impractical with hot cathode diodes used elsewhere in LEO.

In 1953, when the machine was ready for use, the entire clerical staff of Lyons, numbering more than 2,000, was brought to Cadby Hall in batches of 30 to see a demonstration of LEO. Within six months, LEO produced part of the payroll for the Ford Motor Company at Dagenham. Early in 1954, LEO started doing the Cadby Hall payroll and other jobs followed rapidly, including bakery sales and tea shop orders.

Lyons saw LEO I as a considerable success and it remained in service until 1954. They invested in a design of an improved model for small scale production and sale, LEO Mark II, which ran about three times faster than LEO I. Eleven LEO II's were built — all of them slightly different.

Before the end of the fifties, it became obvious that a parallel transistorized machine was feasible and we embarked on LEO III. This was a 40-bit parallel machine of advanced architecture incorporating (as we later found out) many ideas also used in the IBM 360 series. Besides the multiple, buffered I/O channels provided by LEO I and II, it had multi-radix, as well as floating point arithmetic, extremely effective checking of data recorded on tape, direct input and output to and from main store (DMA) and 4 protection tag bits to each word in store allowing multitasking with up to 15 jobs. It was, I believe, also the first machine using microprogramming to go into production anywhere in the world.

About 150 LEO III's were built and sold. However, the capital demands of a growing business persuaded Lyons in 1963 to merge the computer department with English Electric. Later they sold their half share of the joint company to English Electric. While no LEO III's remain in use, a few System 4 machines from English Electric and 2900 series models from ICL have micro coded implementations of the LEO III instruction set, thus allowing one valued customer to continue to use an interlocked suite of programmes originally written for LEO III in the mid-sixties.

Calendar Winter 1987/88

Feb 6
Saturday
2 PM

Choreo Graphs

Choreographer Alice Trexler explains her work in computer dance with a live demonstration of body movements interacting with computer screen displays.

Feb 7
Sunday
3 PM

Experiments in Computer Graphics and Art

Graphics pioneer Ken Knowlton will present an illustrated lecture on the evolution of his work from the sixties through the eighties.

Feb 20-21
Saturday-Sunday
10 AM
- 5 PM

Third Annual Kids Computer Fair

Try out some of the latest educational and entertaining software for students ages 4-14. Play with robot toys. Learn about computer related activities in a special resource center.

Feb 28
Sunday
3 PM

LEGO/Logo: Building a New World in the Classroom

Stephen Ocko and Mitchel Resnick of MIT's Media Laboratory will demonstrate a LEGO-based smart machine. They will also illustrate how children learn about the world by using personal computers and sensors to transform LEGO building sets into sophisticated toys.

March 6
Sunday
3 PM

Beyond Nature: Computer Graphic Simulations of Life

Peter Oppenheimer of The Computer Graphics Laboratory, New York Institute of Technology, will introduce and discuss his computer-generated experiments that create surreal forms of life captured on video.

March 13
Sunday
3 PM

Intelligent Machines of Today and Tomorrow

Raymond Kurzweil, inventor of a reading machine for the blind and other computer-based devices, will talk about artificial intelligence and introduce the special film the Kurzweil Foundation produced, "The Age of Intelligent Machines".

March 19
and 20
Sat and
Sunday
12:30 and
3:00 PM

SIGGRAPH Electronic Theatre 1987 Part 1

Four showings over the weekend of the edited tapes from SIGGRAPH 1987 with commentary by an authority.

March 26
and 27
Sat and
Sunday
12:30 and
3:00 PM

SIGGRAPH Electronic Theatre 1987 Part 2

Four showings over the weekend of the edited tapes from SIGGRAPH 1987 with commentary by an authority.

The Computer Museum

The Computer Museum is a non-profit 501(c)3 foundation that chronicles the evolution of information processing through exhibitions, archives, publications, research and programs.

Museum Hours: *Summer:* Open daily 10 - 5, Friday 10 - 9. *Winter:* Open Tuesday - Sunday 10 - 5, Friday 10 - 9. Open Mondays during Boston school vacation weeks, 10 - 5. Closed Thanksgiving, Christmas, and New Years Day. Hours are subject to change.

Membership All members receive a membership card, free subscription to The Computer Museum Report, a 10% discount on merchandise from The Computer Museum Store, free admission and invitations to Museum previews. For more information contact Membership Coordinator at The Computer Museum, 300 Congress Street, Boston, MA 02210. Telephone (617) 426-2800.

Staff

Joseph F. Cashen, *Executive Director*
Dr. Gwen Bell, *Founding President*
Dr. Oliver Strimpel, *Curator*
Kurt Levitan, *Technical Coordinator*
Tom Merrill, *Exhibits Technician*
Lynn Hall, *Registrar/Collections Manager*
Bonnie Turrentine, *Education Director*
Michael Chertok, *Education Assistant*
Gregory Schroeder, *Operations Manager*
Mark Hunt, *Marketing Director*
Gail Jennes, *Public Relations Manager*
Laura Goodman, *Store Manager*
Robert Gates, *Assistant Store Manager*
Linda Holekamp, *Communications Assistant*
Kathleen Keough, *Functions Manager*
Michael N. Oleksiw II, *Development Director*
Scott Reilly, *Development Coordinator*
Toni Dunham, *Membership Coordinator*
Mark R. Allio, *Director of Finance & Administration*
Brian McLaughlin, *Accountant*

Public Relations Committee

Cabot Public Relations
Geinther/McGowan
Germain/DRK
GR PR, Inc.
Hill and Knowlton
Sterling Hager, Inc.

Advertising Consultant

Abbot Ames Advertising

Designer

Michael Sand, Inc.

YES I want to become a Member of The Computer Museum.

\$20 Student \$ 45 Family \$250 Sponsor
 \$30 Individual \$100 Donor \$500 Patron

Members receive free admission for one full year, invitations to exhibit previews, advance notice of exhibitions and lectures, invitations to members-only events, a subscription to our quarterly magazine, The Computer Museum Report, and a 10% discount in the Museum Store.

Enclosed is my check made payable to **The Computer Museum** for \$_____

or charge to: VISA MasterCard American Express

Card # _____ Expiration Date _____

Signature _____

Name _____

Address _____

City _____ State _____ Zip _____

The End Bit

0000000000000001

Among the items in the Museum's ephemera collection was our own "UNIX license." This was made by a group of software people in New Hampshire to look like their state license plate so that they could offer a "UNIX license" to any customer. Donor Anonymous.

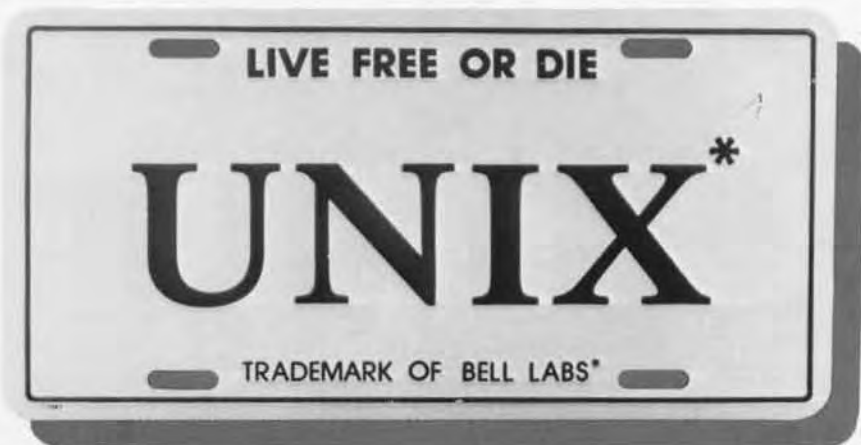

Photo: Jerry Rabinowitz

Address Correction Requested

Non-Profit
Organization
U.S. Postage
PAID
PERMIT NO. 110
FITCHBURG, MA
01420

THE COMPUTER MUSEUM REPORT

VOLUME 22

SPRING 1988

Wizardry®



Board of Directors

John William Poduska, Sr.
Chairman
Stellar Computer, Inc.
Joseph F. Cashen
Executive Director
The Computer Museum
Gwen Bell
Founding President
The Computer Museum
Erich Bloch
National Science
Foundation
Lynda Schubert Bodman
Schubert Associates
David L. Chapman
Callimet Software, Inc.
David Donaldson
Ropes and Gray
John J. Evans
Manufacturers
Hanover Trust
Sydney Fernbach
Computer Consultant
William Foster
Stratus Computer
Thomas Gerrity
Index Systems, Inc.
Gardner Hendrie
Sigma Partners
Max D. Hopper
American Airlines
Arthur Humphreys
ICL
Mitchell Kapur
On Technology, Inc.
August Klein
MASSCOMP
Koji Kobayashi
NEC Corp.
Robert Lucky
AT&T Bell Laboratories
J. Carl Masi
International
Data Corporation
James L. McKenney
Harvard Business School
Carver Mead
California Institute
of Technology
Robert M. Metcalfe
3Com Corp.
Arthur P. Moliola
The National Museum
of American History
Smithsonian Institution
Laura Barker Morse
Russell Reynolds
Associates
David Nelson
Apollo Computer, Inc.
Russell Nofsker
Symbolics, Inc.
Nicholas Pettinella
Intermetrics, Inc.
Jonathan Rotenberg
The Boston Computer
Society
Jean E. Sammet
IBM
Edward A. Schwartz
Digital Equipment Corp.
Naomi Seligman
The Research Board
Paul Severino
Wellfleet Communi-
cations, Inc.
Hil Shear
Pell Rudman & Co., Inc.
Irwin J. Sittin
Aetna Life & Casualty
Ron Smart
Digital Equipment Corp.
William J. Spencer
Xerox Corp.
An Wang
Wang Laboratories, Inc.

Trustees

Charles Bachman
C. Gordon Bell
Harvey D. Crogon
Robert Everett
C. Lester Hogan
Theodore G. Johnson
Andrew Knowles III
John Lacey
Patrick McGovern
George Michael
William Millard
Robert Noyce
Brian Randell
Kitty Selfridge
Michael Spock
Erwin Tornash
Paul Tsongas
Maurice Wilkes

Executive Committee

David Donaldson,
Chairman
Joseph F. Cashen
Gardner Hendrie
James McKenney
Nicholas Pettinella
John William Poduska, Sr.
Jonathan Rotenberg
Edward Schwartz
Paul Severino

Operating Grants

Corporate Membership

Sustainer—Over \$10,000

Digital Equipment Corp.
Hewlett-Packard
IBM
Massachusetts Council
for the Arts and
Humanities
Sequent Computer Corp.
Sun Microsystems
Symbolics, Inc.
Xerox Corporation

Benefactor—\$10,000

Aetna Life & Casualty
Kurzweil Music Systems
MASSCOMP
NEC Corporation
Raytheon Company
Tandy/Radio Shack Corp.

Patron—\$3,000

Amdahl Corporation
BankLink, Inc.
Boris Color Labs, Inc.
Coopers & Lybrand
DECUS
Dentsu, Inc.
Draper Laboratories
Fenwick Partners
Gaston & Snow
Gourmet Caterers, Inc.
Honeywell Bull
Lotus
Manufacturers Hanover
Maxell Corp. of America
McGraw-Hill, Inc.
Phoenix Technologies
Prime Computer, Inc.
Roster Technologies
Ropes & Gray
Stratus Computer
Sun Microsystems
The Travelers Companies
UNISYS
Zenith Data Corporation
Ziff-Davis

Contributor—\$1,000

Adage, Inc.
Adelle Corp.
Analog Devices, Inc.
Apple Computer
Arthur Andersen, Inc.
Arthur D. Little, Inc.
Bachman Information
Systems
Bank of Boston
Bank of New England
Banyan Systems
BASF
Banybank
Bell Beranek & Newman
Boston Consulting Group
Boston Safe Deposit
Cambridge Institute for
Information Systems
Cincom Systems
Cogitation, Inc.
CompuServe
Dane, Fair, Stone & Co.
Data Architects, Inc.
Data Translation
Deloitte Haskins & Sells
Dragon Systems
Easch Management
E.I. DuPont de
Nemours Co.
E.M.C. Corporation
Festive Foods Caterers
Gillette Company
Grafik Communications
Lid.
Goldman, Sachs & Co.
Greater Boston Chamber
of Commerce
GTE Laboratories, Inc.
Hub Mail Advertising
Hyams Trust
Index Technology
Infocom
Informart
Intel Corporation
Interface Group
Interleaf
Mentor Graphics
Merrill Pickard Anderson
& Eyre
Microm
Micro Control Systems
National Semiconductor
NYNEX Service Company
Orchard Computer
Palmer & Dodge
Peat, Marwick & Main
Pell, Rudman & Co., Inc.
Phase3 Systems
Rossin, Greenberg,
Serotnick & Hill
Russell Reynolds
Associates
Schubert Associates
Sctex America
Shawmut Corporation
Sterling Hager
Technical Data

International
Teknowledge
Telectronics
Teleprocessing, Inc.
Teradyne
Testa, Hurwitz & Thibault
The Technology Research
Group
VSI
VM Software
Wallingong Group
XRE Corporation

Contributing Members

Donor—\$500 or more

Roland Arndt
Burlington Public Library
Michael Callahan
David Cutler
James B. Deckerick
Nick De Wall
David Dinkie
Roy Duncan
Tom Eggers
Ed Feigenbaum
Branko Gerovac
Tom and Rosemarie Hall
Martin Kirkpatrick
Raymond Kurzweil
Lawrence Public Library
Thomas Maril
Christopher Morgan
Linda J. Phillips
Paul R. Pierce
Audrey Reith
Linda & David Rodgers
Curtis Scott
O. & K. Selfridge
Sharon Public Library
Thomas F. Stephenson
Seth Stern
William Steul
Chuck Woodward

Sponsor—\$250

Timothy Andetson
Anonymous
Isaac Auerbach
Dawn R. Banks &
Robert M. Proutius
John Barstow
Jordan Baruch
Graham Beachum
G. C. Belsian, Jr.
James Bell
Gordon S. Brown
Roger M. Guioy
Peter Capek
George Chamberlain
George Champagne
Richard J. Clayton
Clement Cole
Richard Corbin
Phil Dorn
Dick Dunnington
Lucian J. Elicott
Bob O. Evans
Neil Faiman
Andrew Feit
Henry Fuchs
Kevin and Judith Galvin
Walter Gamble
James Harviston
J. Milton Hutson
W. Richard Johnson
Bob King
Alex Koller
Sheldon Labube
Paul Leach
John R. Levine
Eli Lipson
Carl Machover
Barry Margolin
Andrew H. Mason
Charles Minter
Joseph M. Newcomer
Anthony Oettinger
PCK Technology Division
James N. Porter
John F. Pyles
C. M. Riggle
Michael Roberge
Linda & David Rodgers
Michael J. Sarnek
Michael Thompson
G. Michael Uhler
Christian Walker
Allan L. Wallace
S.W. Welch
Andrew Wilson
William Wull

Capital Campaign

64K or more

Apollo Computers, Inc.
C. Gordon Bell
Control Data Corporation
Callimet Software, Inc.
Data General
Gardner Hendrie
Mitchell Kapur
Carver Mead
Kenneth Olsen
John William Poduska, Sr.
Wang Laboratories

32K or more

American Telephone &
Telegraph
Bank of America
Henry Burkhardt
ComputerLand
Kenneth Fisher
International Data Group
Burgess Jameson
Mitre Corporation
Russell Nofsker
Robert Noyce
Robert M. Metcalfe
Fontaine K. Richardson

16K or more

American Management
Systems
Anonymous
Clark Baker
Robert Berkowitz
The Boston Globe
Howard Cannon
David Donaldson
Doug Crane
David K. Dyer
Bruce Edwards
Index Systems
August Klein
Thomas Knight
James L. McKenney
NEC Corporation
David & Pat Nelson
Paul & Katherine Severino
Ron Smart
William Spencer
Charles E. Spork
Ivan Sutherland
System One
Chris Terman
Minoru Tonal
Stephen Watson
Daniel Weinreb

Friend—\$100

Kenneth R. Adcock
R.J. Alexander
Robert Allio & Assoc.
Professor Arvind
Robert Z. Bachrach
Richard G. Bahr
Mario Barbarci
Steve F. Bameby
Luis J. Bank
David Banner
Bontronics
John Brackett
Daniel S. Bricklin
Robert E. Briny
Fred & Nancy Brooks
Lawrence Brown
Brown University
Erik Bruhn
David Bryant
Gerald A. Bujarcus
David Bunnell
W. Carlson

Roy C. Johnson
Lisman Jones
Charles A. Jortberg
JSI, Inc.
Richard M. Karoff
Paul Katz
Gary Kessler
Richard King
Robert King
Mark Koritz
Stanley Kugell
Marvin Kuritt
Robert Lamont
John Langell
Curtis Laroek
Tsvi Lavi
Grace Leahy
Margaret L. Letby
John V. Levy
Joseph L. Levy
Jon Liebman
John D.C. Little
Reed Little
George Logemann
Carl D. Lowenstein
Arthur Luehmann
Michael Mahone
Julius Marcus
Melvin J. Mason
Richard O. Mason
Suzyl Masquelet
J. Steward Massey
Peter Masters
Robert Mayer, Jr.
Robert McCormick
F. Warren McFadden
Douglas McKenna
William McLean
Todd Medlock
James Meehan
R.W. Meister
Micro-Net Data
Jeanette Middour
Allen Moulton
Rayman Mustata
Isaac R. Nass
Steven Nevus
Landon Noll
Bernard J. Nordmann
David Novak
H. Edward Nyce
Thomas P. Oberst
James N. O'Boyle, Jr.
Martin O'Donnell
Lawrence & Pauline Oliva
Robert Ornes
Leon M. Padell
Joseph A. Pallone
Kenneth D. Patterson
James V. Patton
George Peo
Emel Petricies
James H. Philip
Michael Pique
Michael Poe

8K or more

AFIPS
Harlan E. & Lois Anderson
Erich & Renee Bloch
Winston R. Hinkle, Jr.
Theodore & Ruth Johnson
John Allen Jones
J. Carl Masi
Stan Olsen
Russell Plautner
Doug
Gert & Dorn Saviers
Edward Schwartz
Software Results Corp.
Erwin Tornash
William Watson
Xerox Foundation

4K or more

Charles & Connie
Bachman
Gene Bauer
Robert and Mary Cady
R. Steve Cheyhl
Robert & Eleanor Chinn
Pat Clark
Robert G. Claassen
Stephen Calt
William Congleton
Alex d'Arbeloff
Arnoud de Vitry
Robert Everett
Ford Motor Company
Jay W. Forrester
William Foster
General Systems Group
Gaston & Snow
Peter Hirschberg
Houghton Mifflin
Company
ICL
Jeffrey Kalb
Allan Kent
Jack S. Kilby

John Poppen
John H. Porter
David Potter
Richard Powell
Prattonic Corp. of
America
Brendan Reilly
Steven Reilly
Nicholas Reinhardt
Terry Robinson
Ann Roe-Hater
Thomas S. Roy II
Stephen Russell
Sabata Corporation
Howard Salwen
Michael Sand
Robert Santy
Robert Schappo, Jr.
Stanley Schultz
Bennett Schwartz
Andrew Scott
Curtis A. Scott
Aaron Seidman
R. & M. Shamel
Benson Shapiro
W. Lee Shevel
Dan Siewiorek
Diane J. Skiba
Phil Slaughter
Allen G. Snider
Gerald Steinback
Max J. Steinmann
Bruce G. Stewart
Hugh W. Stewart
Robert and Diane Stewart
J. Michael Storie
Charles A. Stott
Joel Sugg
Steve Swerling
David Tarabot
John Tartar
Paul Tedesco
John Tenney
William R. Thompson
Warren G. Tisdale
Michael Tomasic
H. Dean Tombs
F. & M. Trappell
Robert Trudel
David Tweed
Noah E. VanDenburgh
Charles Volkstor
David P. Wick
Hugh Wilkinson III
James Williams
Kevin Willoughby
Roy Wilson
Richard T. Wittek
Frederic G. Withington
John Woodward
D. L. Wyse
Leo Yochum
Hermann Zapf

Andrew C. Knowles III
David J. A. Koogler
Edward and Debbie
Kramer
John W. and Edna W.
Lacey
Liberty Mutual Insurance
Company
Ralph and Linda Lin-
sclate
Robert Lucky
John Norris Maguire
Richard D. Mallory
Thomas and Marian
Marill
Daniel D. McCracken
Thomas and Elizabeth
McWilliams
Meditech
Allen Michels
Microsoft
Robert M. Morrill
Luzara & Ken Morse
New York Air, Inc.
Nolan Norton Company
John L. Payne
Nicholas A. Pettinella
Edward G. Perkins
Robert M. Price
Regis McKenna, Inc.
Ben Robelen
Jean E. Sammet
Sequent Computer
Systems Corp.
Hal Shear
Alan F. Shugart
Richard L. Sites
Stratus Computer Corp.
Del Thomaik and Steve
Teicher
3Com Corporation
Jean De Valpine
Charles & Angela Waite
Harvey W. Wiggins, Jr.

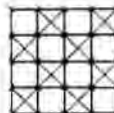

The Computer Museum
Museum Wharf
300 Congress Street
Boston, MA 02210

25th Anniversary of Computer Games Weekend



Mike Harrison chuckles while Ken and Laura Morse crash their "F-15 Strike Eagle."

Twenty-five years or more of computer games? That may be hard for people raised on "Pong" or "Asteroids" to believe. It seems like just yesterday video games invaded the arcades of America with their blinking lights, blips and beeps.

But for the flock of game aficionados and members of the press who descended upon The Computer Museum November 6-8, twenty-five years sounded just right.

Why? Because three of the inventors of the world's first interactive computer game were there. In 1962 a group of M.I.T. hackers working on the school's recently-acquired PDP-1 computer collaborated to create the game, known as Spacewar! It was perhaps as humble in its origins as it was powerful in its impact. With a multitude of computer and video games now solidly in place in homes, offices, schools, bars and arcades throughout the country, it seemed entirely appropriate for The Computer Museum to host an anniversary celebration.

The Computer Museum Report

While the weekend's spotlight focused first on Spacewar! and the historical side of computer games, it then went on to highlight a range of other events. Panel discussions on both the past and future of games, micromouse robot demonstrations, a birthday party, Core War tournament, and lots of representative computer games — all were ingredients of the Anniversary Weekend.

The weekend lifted off with a Gala Birthday Party, Friday night, when three of the original Spacewar! inventors — Steve "Slug" Russell, Alan Kotok and Martin "Shag" Graetz — were reunited. They were joined by a number of other prominent game inventors and experts who reminisced about computer game history and explored some of the industry's latest trends. Mingling with 150 of the Museum's guests and game devotees, these pioneers added to the catered dinner's general mood of festivity and nostalgia.

In addition, almost two dozen games were located around the Museum's fifth floor galleries for public use the entire weekend. They gave active testimony to the evolution of computer games: from Spacewar! and its unwieldy PDP-1 mainframe (part of the Museum's permanent collection) to the three-dimensional colored sights and stereo sounds of "Marble Madness" or "The Halley Project" on an Amiga personal computer.

Table of Contents

Cover: Close-up of the back of Roe Adams's jacket at Computer Games Weekend. Photo: J. David Bohl

25th Anniversary of Computer Games Weekend 1

The Beginnings of Computer Games 3
David Ahl

The Future of Computer Games 6

Whirlwind's Genesis and Descendants 10

Whirlwind's Success 10
Jay Forrester

Discovering a "New World" of Computing 14
Robert R. Everett

From World War II Radar Systems to SAGE 15
C. Robert Wieser

Saturday featured a two-part symposium entitled "The Coming of Age of Computer Games." The morning session addressed the history of computer games, while the afternoon discussion focused upon the present and future of the games industry (see separate articles). Both sessions drew interested crowds to the Museum's auditorium.

Sunday's events were perhaps the most unusual of the weekend. David Otten and his team from M.I.T. made the most of a ten foot by ten foot maze to run their world champion MITEE micromouse through its paces. MITEE and a companion mouse dazzled the audience as they used infrared sight, computer memory and impressive acceleration to track the fastest route from start to center point in the maze. Micromouse teams from West Point Military Academy and Northeastern University were also on hand to learn some pointers and see the champ in action.

Running concurrently with the micromouse demonstration was a Core War teach-in, followed by the Second International Core War Competition. Twenty-five to thirty people took part in the informative session, led by Core War pioneer A.K. Dewdney and Core War Society Chairman Mark Clarkson. The participants learned about some of the more successful strategies and how to design their own Core War program. A Core War pits two programs, one against the other, in an attempt to gain control of a computer's memory. The eight quarter-finalists in this year's contest were narrowed down from a field of 130 and included the two finalists from a similar competition in Japan. The round robin style eliminations eventually trimmed the entries down to two — Ron Paludan's



Charlie and Connie Bachman try their luck at "Spacewar!"

Jerry Ratajowski

PLAGUE, and FERRET by Robert Reed. FERRET proved victorious in the best of five series, so that Reed succeeded last year's winner Chip Wendell on the Core War throne.

In addition to providing a festive opportunity for both the serious and the light-hearted gamer to enjoy a favorite subject, the weekend prompted national and international media coverage (from "Entertainment Tonight," Cable News

Network, USA Today and stories by the AP, UPI and Reuters, to extensive features in the Boston Globe, Boston Herald and other local news outlets).

Coordinated by David Havlick, the weekend brought action to all aspects of the Museum. Our collections grew, members had a good time, and ideas for future games activities were generated. Watch out for Computer Games Month next November!

Players concentrate to stay alive in "Mazewars" and "Wizardry."



Linda Holkamp

The Beginnings of Computer Games

David Ahl

This is adapted from a keynote talk at The Computer Museum's Computer Games Weekend, November 6-8, 1987. David Ahl is the founder of Creative Computing, the first magazine that focused on all the uses of the personal computer from games to science and home business.

What Makes a Good Computer Game?
It takes many elements on several levels, skillfully combined, to make a good computer game. For example, good computer games are easy to learn, but not easy to beat. They are a challenge to expert players, but accessible to novices. They have elements of fantasy, but do not totally abandon reality. They are fun and keep us coming back for more.

One way of thinking of the world of computer games is as a Venn diagram of games, puzzles, and simulations (Figure 1). Simulations are representations of real-world processes such as a journey over the Oregon Trail, the landing of a lunar capsule, or a game of blackjack. Puzzles are problems with a baffling quality or great intricacy that require substantial mental ingenuity to solve such as the Chinese ring problem, the Lady and the Tiger, or even tic-tac-toe. And games, we know, can range from fantasy to shoot 'em up to Pacman.

Although thousands of computer games have come and gone, only a handful, such as Spacewar!, will be considered classics. I believe, in general, these classics will fall in the middle area of the Venn diagram. They will have some elements of fantasy, of simulation of real-world processes and people, and of puzzlement. While graphics may add to the visual presentation, they aren't really necessary. For example, the text



David Ahl brings fun and computing together with his books and magazines on computer gaming.

adventure games from Infocom and others have elements of fantasy, simulation, and puzzlement which provide many layers of interest and challenge to a wide variety of players.

The First Computer Game.

Not only are we celebrating the twenty-fifth anniversary of Spacewar!, but in 1987, the thirtieth anniversary of computer games themselves.

The first computer game was developed in 1957 by Willy Higinbotham at Brookhaven National Laboratory. This is not widely known, and has not been widely written up, but I do know that some of the current games writers saw it and were influenced by it.

In the late fifties, people thought of computers as magic. At Brookhaven National Laboratories, one of the centers of atomic energy research, tours were held to educate the general public. Higinbotham noted that the visitors really

couldn't relate to any of the machinery. He took a five-inch oscilloscope and devised a game. He used potentiometers to adjust the angle of little paddles in the bottom two corners. He put a line that represented a net in the middle and had a blip that bounced back and forth over the net, thus devising a simple game of tennis. The player adjusted the angle of the paddle to hit the ball higher or lower. You actually couldn't see the paddles but had to guess, based on turning the knobs of the potentiometer. One nice feature was that you always hit the ball if it came over the net. If you hit it into the net or over your head you lost. It wasn't a tremendously challenging game, but in 1957, it represented something that was "neat" and fun. I was a senior in high school, saw it and thought that it was spectacular. That was the first computer game even though it involved some special electronics and a mainframe with the capability of a small Atari today.

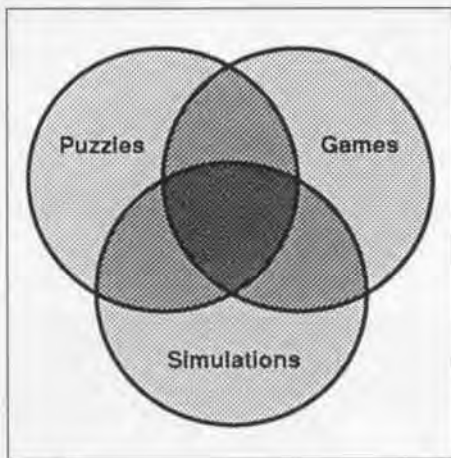

Figure 1

The First Widely Used Computer Simulation.

In the early sixties, the faculty of the business school at Carnegie started to build a monstrous business simulation known simply as "the management game," which in a form is still being used. The concept was set down in the late '50s to devise a simulation of the detergent industry, to allow students to take the role of companies and compete against each other, with a week equalling a year and play continuing for twenty years. What started as a simple marketing game then became more and more complex as other modules were added. In 1961 and '62, as the concept developed, additional modules were made for different areas such as research and production. A major challenge was getting these all to work with each other. It started to become a truly interactive simulation even though we had to feed the machine 3000 punched cards a week to run the model.

The original game was written in a language called GATE on a Bendix G-15 computer. In my second year at the Graduate School of Industrial Administration, I had a job to convert the program into the new language called FORTRAN. (I got the job because at the time I was one of the few people who knew FORTRAN, having learned it working at Grumman Aircraft on an IBM 704 simulating the cockpit controls of jet fighters.)

The PDP-8 Educational Simulations.

In 1969 when I joined DEC there really wasn't an educational market. The PDP-8s spoke machine language and FOCAL, an interactive language modelled on ALGOL written at DEC by Rick Merrill. It was a very interesting and powerful language that, in hindsight, could have been the generic language if DEC had made it widely available. Then BASIC would not have had a chance.

Rick Merrill also developed some simulation games — which is what interacting with a computer is all about. In one of these, Hammurabi, students manage a little city-state where they buy and sell land, feed their subjects, protect grain warehouses from rats, save grain

for planting next year's crop, and deal with lots of little interacting variables. We fit both FOCAL and the program into the 4K memory available on the PDP-8. The original program was about 700 bytes. Since the world was not beating a path to DEC's door to buy FOCAL machines, we contracted with others to write BASIC for the PDP-8.

The BASIC Interpreter for a stand-alone \$8500 4K PDP-8 with a teletype Model 33 used 3.6K of the memory. This left 400 bytes for the program. One of the first programs we managed to jam into this little machine was Hammurabi, which was soon followed by Lunar Lander — a game derivative of Spacewar!

Level two of selling machines to schools was to sell time-shared systems. But these were hard to explain so we developed a demonstration. When we brought this to the Brockton School System they wanted to schedule it in the auditorium so that the citizens could come and approve this major expenditure for the school. The first problem was finding the nearest telephone and running a cord down the hallway to the auditorium. We brought our ASR 33 teletype and set it up onstage. A pamphlet explaining a scenario of interactions on Hammurabi was distributed to the audience. Then Jim Bailey dialed the computer at Digital. He heard the tone and it spelled out, "Logon please." He entered an account number and it replied "Logon please." After several iterations he realized the system was down. Since he was up on the stage, Jim said, "Hammurabi has just come back and said, 'How much do you want to plant?'" No matter what key he pressed, the computer replied "Logon

please." When the demo was over, Jim crumpled up the paper and put it in his pocket. The bottom line: Brockton bought the \$58,000 system — the first Time-Shared 8 in a New England school.

BASIC Computer Games.

At DEC there was little enthusiasm for publishing or distributing computer games. I was convinced they were of interest to our users. Because there was no support to publish BASIC Computer Games, I said "I'll just do it. It won't cost anything. I'll type it in and do the layout myself." It wound up costing DEC next to nothing and surprised everyone, even me, by selling out of the first printing of 10,000 in three months. In 1979, it became the first million selling computing book, in a version based on Microsoft BASIC under the Creative Computing label.

Its sequel, *More Computer Games*, did well, but the third book in the series, *Big Computer Games*, was printed but not distributed by Ziff Davis. My most recent book, *Basic Computer Adventures*, published by Microsoft Press in 1986, has ten simulations of real adventures such as the travels of Marco Polo and Amelia Earhart with a few puzzles built in.

The First Personal Computing Magazine.

In November 1974, the first issue of *Creative Computing* came out, devoted to the idea that computers can be fun, not just business.

Nolan Bushnell's Second Game.

His first game was Computer Space, very much like Spacewar!. Unfortunately, it was distributed in the coin-op environment, bars and taverns, where the guy with a beer in one hand and a joystick in

The Digital PDP-8 computer with teletype was one of the earliest computers introduced into public schools.



Digital Equipment Corporation

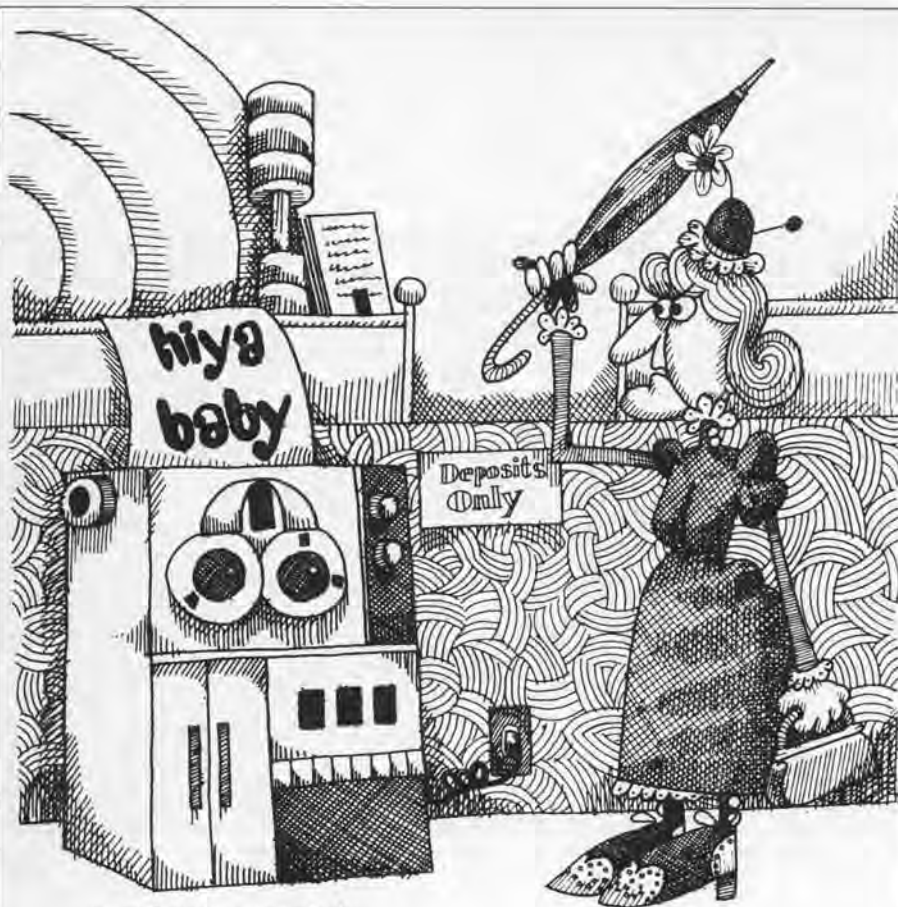

Here is how the program looks:

```
01.05 SET RATE=.ARS
01.10 TYPE !!!!!,"HI THERE, GOOD LOOKING. HOW MUCH MONEY DO YOU WANT",!
01.20 TYPE "TO BORROW ?"ASK PRINCIPAL
01.30 TYPE "THANK YOU DEAR. HOW LONG DO YOU WANT TO BORROW THE ",!
01.40 TYPE "MONEY FOR ?"ASK TERM
01.50 SET INTEREST=PRINCIPAL*RATE*TERM
01.60 TYPE ,!, "SWEETS, THE GOING RATE OF INTEREST IS R.5%. IT WILL",!
01.70 TYPE "COST YOU",INTEREST," DOLLARS TO BORROW",PRINCIPAL
01.80 TYPE " DOLLARS",!, "FOR ",TERM," YEARS. YOU DO UNDERSTAND"
01.85 TYPE ", OF COURSE",!, "THAT THIS IS SIMPLE INTEREST",!!
01.90 TYPE "STEP RIGHT UP TO OUR TELLER AND HE WILL BE GLAD TO",!

02.10 TYPE "HELP YOU.",!!
02.20 TYPE "NICE TALKING WITH YOU. DO STOP IN AGAIN. BYE,BYE,NOW.",!
02.30 GOTO 1.1
*
```

Digital's conversational programming language, FOCAL, may have had great potential for the PDP-8, but was soon overshadowed by the popularity of BASIC.

another wasn't up to learning the complexities of Spacewar!. Atari produced about 2,000 units but it never really was a big success.

Pong, a very simple and clever game, was a runaway hit. The story is that the first Pong game was put in a bar near Sunnyvale. Several days later Bushnell got a call asking him to take the game out because it didn't work. He took a look at the game and found that the breadpan of quarters was so full that the coins were jamming the mechanism. When the quarters were emptied once a day, it worked well. Eventually game designers built large coin receptacles eight inches deep under the whole machine.

The Video Computer System (VCS).

There was no one device more responsible for getting computers and games into people's homes than Atari's VCS (called the 2600 today). First announced in 1978, it sold by the millions

and got people thinking about games and computers.

Computer Games Overdose.

By 1982, over 6 billion dollars of quarters per year were being put into the slots of coin-op games alone, making that segment of the industry bigger than the rest of the sports industry combined, including football, the Indy 500, World Cup Soccer, and the Olympics. Hundreds of new games were announced and the life of a game went from over one year to less than two months. Less than one year later, boom turned to bust as manufacturers slashed prices and flooded the market with "me-too" products. Players got disgusted, and manufacturers, retailers and arcade operators started to go "belly up." The boom ended, but the games will go on forever.

The Beginnings of Rogue

Ken Arnold, the co-designer of Rogue, spoke about how he co-invented it less than ten years ago at Berkeley.

Since I'm less than thirty, I'm awed that I'm part of a history section. When I was first an undergraduate at Berkeley, the terminal room had ADM machines where you could only move the cursor down the page. This limited us to text games like Adventure and Rogue for the people who had ARPAnet accounts. Then came the dumb terminals where the cursor could move anywhere on the screen. That was really a boon to gaming. Then, people started to CRT hack...that is, draw pictures on the screen and move them around. For about two months that seemed to be entertaining. Some people decided that this was the way to start writing games.



Ken Arnold and "Rogue," a program that took "a billion and a half dollars of compute time."

Rogue was developed by Michael Toy at Santa Cruz. He then came to Berkeley when the game had no real magic, such as potions. I had written some utilities to use the cursor on the terminal and so he came to me to help me. Having a lot of recommendations to change the game that I was now addicted to, we started to work together.

Michael set four goals that were unique at the time. First was to move away from text-only adventure games that are essentially mazes with the player as the mouse.

Second, Michael wanted to write a game that would be different for the player every time and interesting for the writer to play, the innovation was to use a random number generator to create new landscapes each time.

The third decision was to make a game that was impossible to win. Without a couple of forms of cheating, Rogue is only possible to win one out of every hundred thousand times.

Finally, Rogue was designed as a long game — taking two or three hours to play and thus it never became appropriate for an arcade.

Rogue is one of the most copied games; after royalties the second most sincere form of flattery. After three months at Berkeley, the game used more compute cycles than any other program. Two years after Michael and I released Rogue, we calculated on the back of an envelope that we had used about a billion and a half dollars of compute time in Silicon Valley.

The Future of Computer Games

Panel: Dan Bunten, Chris Crawford, Dave Lebling, Tom Snyder, A. K. Dewdney, moderator

These are some highlights, adapted from a panel discussion at The Computer Museum's "Computer Games Weekend," November 7, 1987. **Dan Bunten** is the designer of the award-winning games "M.U.L.E." and "Seven Cities of Gold." **Chris Crawford** designed "Balance of Power" and wrote *The Art of Computer Game Design*. **Dave Lebling** works for Infocom; his games include "Zork" and "The Lurking Horror." **Tom Snyder** produces educational software such as "Puppy Love" and "Snooper Troops." Scientific American columnist **A.K. Dewdney** pioneered the *Core War* computer program competition.



Afternoon panelists Dan Bunten, Tom Snyder, Chris Crawford and Dave Lebling share a laugh.

A.K. Dewdney:

We are all aware of the general view of computer games as mindless spinal recreations involving nothing higher than the cerebellum, that little mass of gray matter above your neck that helps you to play the piano, tennis and also to shoot hostile aliens. There are some who understand that there's a lot more to some computer games than that. I would say the intellectual content of games bears watching. A key question is: what is going to happen to that intellectual content in general? Will these games become more demanding at the cerebral level than at the cerebellar?

Sometimes to be educational, a computer game gives up recreational content. At the same time, it almost seems that the more recreational a game, the lower a common denominator it demands. Another important theme is the single player versus multi-player issue. I submit that there are no four people more competent to describe the current place of computer games and their future prospects than the four game designers [on this panel].

Beyond Nerddom: Multi-Player Games

Tom Snyder:

In 1962, I was introduced to nerddom. I found a book on computer relay circuitry written by Bell Telephone. And I designed a couple of binary coded decimal computers. I thought I invented digital electronics. My father told me I ought to send my paper plans to IBM, which I did. I was twelve at the time and I knew it was cute, not important. About a month later, when I came home from school, there was at least \$10,000 worth of computer equipment on my front lawn with a note from the president of IBM saying, "Remember us when you get older." (joke)

I proceeded to go off the deep end at that point and told my parents that I'd like to make this computer I'd designed because I had the parts to do it. So all I did was computers because they were the one thing I could control in my life. When I was sixteen I gave them up because I had basically no social skills and found I couldn't get along with people. Since then, I've had a healthy respect for how uncool computers are for adolescents.

Dan Bunten:

This generation of computer owners doesn't feel comfortable about owning their computers. It's a bit of a sin. It's something we hide in our back rooms. We don't let our families in on it — there are a few inside friends we might tell. "Yeah, I got a computer, but it's back in my office." But you don't bring them all

back there and say, "Hey, we got this great game, why don't we all play it?" You know, it's not part of our social acceptability somehow. That's one of our problems.

I want to reach some level of success that says that now we're communicating with people other than nerds like ourselves.

Snyder:

At a baseball game you do two things — talk about what's going to happen and go to the bathroom. But it's great. There's something extremely social about these sports — it's the talking about it.

Intellivision's two biggest games were baseball and football. I had the problem of finding somebody to play with — I mean grown men don't invite each other over to do trivial things.

Dan Bunten did one of the few four-people games. There were quite a few two-people computer games out there but Dan really pushed the limit. Four people is better than two — that's a real great party. There's a lot of talking, kidding and social context, a lot of self-handicapping. People learn some rules about society when they're playing games. You don't learn rules about society playing with yourself.

Bunten:

Go back to what games were about. They're about people interacting with each other. They're about having fun with your friends. I have to say we're having trouble with that one, but I'm

willing to keep punching out in that direction.

We're forced — if we're playing a computer game — to look at a screen, which forces us to look away from each other. A lot of the fun in a socially involving game is looking at each other, talking to each other over the game. If the computer gets too good at being the focus of attention, then we've lost what we came here for.

Games as Interactive Art

Dave Lebling:

What Dan said is true. The fun is not so much in playing the game but in the social interaction of four people playing the game. The fact that they have to sit there staring at the screen is really a drawback. I agree that multi-player games are really important; I'm not so certain that the technology is there to make them a big market yet. But I'm hoping that the things that will push it along — the way "Lotus 1,2,3" did for personal computers — will come about. At some future date, I think multi-player games will exist and be very good.

I think we're working in a pulp medium and we are working for what is in effect a pulp audience.

Chris Crawford:

All other artistic media are fundamentally non-interactive. Basically what you do with every art form is sit on your butt and absorb it. So we play wonderful music and what do you do? Sit back and listen. We paint a beautiful painting and you look at it. We write a great book and you read the book. But what do you actually do in all this? Nothing. You're passive. And that's a fundamental failure because the human mind is not a passive receptacle. You don't just open up the top of the skull and pour stuff in. The human mind works best when it gets to take the butterfly and tear the wings off it and play with it and

Dan Bunten: "Go back to what games were about... people interacting with each other."



Linda Holakamp

interact with it. That's an absolutely fundamental part of the way our brains work. Yet art has completely failed to recognize that. Why? Well, we didn't have the technology to do it...until today. Now we have the technology to deliver an artistic experience that you can interact with. All of a sudden we have the opportunity for a large leap in the amount of human involvement in the artistic experience.

You can move technology forward on a timescale of months or years, but art? Art takes wisdom, and that takes a long time — decades or centuries.

Artificial personality is an artistic medium or regime dedicated to the capture of human nature through the medium of the algorithm. Now that may strike you as a little sick. Algorithms are cold mathematical equations. Somehow I'm going to try to express human personality through a cold medium like an algorithm? That may sound sick to you, but let me remind you that stone is cold. Look what somebody did with it when they made a statue called The Pieta. What about cat gut? Let's take the insides of a cat, cut him open and stretch out his insides. What are we going to do with that? We're going to play Beethoven's violin concerto.

The technologies of art are cold because they are things. It's what the artist does with the technology that breathes life and warmth into it. There's nothing intrinsically cold about algorithms. It's how much art you bring to them. The fact that so far algorithms have been exclusively in the hands of scientists and programmers is only an indication of how little artistic effort we've made so far.

Snyder:

Movies, books, records have common elements: love, sex, greed, sorrow, happiness, plot development, character development, people caring about each other, people getting angry, people killing themselves, people killing because they're in love.

Bunten:

We can't engage people by making better landing gear. At some level the vast majority of the human race cares about other people more than they care about things. To me, one of the best ways to let them manifest that care in relation to computer games is to make computer games that let people interact with each other and not with emulated, imagined or supposed characters inside a computer, no matter how good they are.

We may think that if we get a great new resolution or great sound shifts, we're going to suddenly have people saying, 'Hey, this is just like TV.' Well so what? TV's already here — we don't need something like TV.



Chris Crawford: "Characters are what we care about."

Linda Holakamp

Interactive Fiction

Snyder:

Interactive fiction is one of the headiest concepts of the '80s. It's also one of the most problematic entertainment forms of the '80s. That isn't to say we shouldn't develop it. Most entertainment software is missing some incredibly important elements that entertainment is all about, some kind of identification and caring about the character.

Crawford:

The single thing I identify as our biggest failure is not putting any characters into our games. That won't solve our problems, but we haven't even reached square one until we have characters. Imagine movies without characters in them. Imagine literature with no characters. Theater with no actors. Take the movie "Star Wars," and take out Darth Vader, Luke Skywalker, Han Solo, Princess Leia, R2D2, C3PO, Obi Wan Kenobi, and what do you have left? "Da daa da da daa daa, zap zap boom. OK, roll the credits..." that's what you've got — nothing.

We really don't have any characters in our computer games. The characters we do have are fake. The best character I've ever seen in any computer game is Floyd, the robot from "Planetfall." Floyd is a cute guy who does funny things and then dies. But you see, if you walk up to Floyd and say, 'Floyd, I hate your stinking guts,' well, then Floyd is still a cute guy who does funny things and then dies. Because you see, Floyd isn't real. He's a fake. He doesn't have any personality. He doesn't feel anything. He doesn't even know you exist. He is a Potemkin Village. And he's the best we've got. In all of computer gamedom, we don't have a single character as rich, as subtle, as complex as Gilligan from "Gilligan's Island." We have yet to climb up to the level of television. It will be an artistic milestone when we get a game as good as the "A-Team" or "Dukes of

Hazzard." So we're in a terrible situation right now.

I say characters are what we care about. When we watched "Star Wars," we didn't care about the spaceship or about the zapping and all of that; what we cared about was the people. We need to put people into our games.

Lebling:

I really want to see games where I sit down and say, 'Floyd, let's not play hucka bucka beanstalk. Let's read Tolstoy,' and Floyd says, 'Ooh, I love Tolstoy,' and you go off into this completely different story. In "Pacman" if you had wanted to learn to coexist with the ghosts, wouldn't it have been wonderful if the author had had that in mind and handled it?

That begins to shade into interactive fiction where we always like to say you are in control of the story. Now we all know that that's really a lie because you really aren't. But wouldn't it be wonderful if you were?

Bunten:

I think that if a story is really important, it can't have a bunch of different endings. If somebody's that excited about this particular story, it's got one ending.

'What ifs' are interesting but they're not the same thing as a compelling story, well told, that involves you and brings you in.

Lebling:

In the real world you get one run through. One of the things about reading books and seeing movies is that it's like getting another run through in that world. You see somebody else's run through and maybe it helps you do yours a little better. If you could do many, many runs in the same interesting world, it might help you even more.

Snyder:

Character development is the key issue that's really holding us back. It's difficult to find an author who wants to write 9 million contingencies; most of them have a vision as Shakespeare did — that there's a character who's going to learn something, who's going to grow because of a sequence of events. Those are the kinds of authors who have existed for the past 2500 years, since Homer's time. They have a personal investment in themselves as artists creating an experience we're going to have. They don't give a damn about what my notion is about the order in which their story ought to take place.

You (Chris Crawford) continue to say that what's important to a good story is characters; I continue to say what's important to a good story is character development. If you just have free-floating characters, it could be interesting, it could be junk. I'm not interested in that.

Lebling:

Even if Floyd is the best character in the world, it wouldn't advance the story. The

characters in popular fiction aren't that complicated. What's important is empathy.

Bunten:

I understand the problem of building characters into a computer, and I sympathize with it. In fact, I would bow out of that problem and say, 'OK, we don't want characters in a computer. We want environments, worlds where I can be the character, the guy who runs out and does the neat things.'

Snyder:

I don't want to be sexist, but I think it's an interesting statistic that more than 50% of all purchase and rental decisions on books and movies are made by women. Do you think for software it's anywhere near 50%? But I don't think we ought to bring women into this just to make the market bigger. We're not going to be happening if we just add another 50% of the population. I'm talking about women having the same kind of synergy that exists around books and records, where the pop culture explodes and grows.

My mother will learn to use any machine if it has those elements of personal emotional identification that are so important to her. The things that are important to mom are stories. She loves to program her VCR because there is content in there that makes a difference to her.

I think our industry has to stop and rephrase some things. There's a kind of

Peter Reynolds and Tom Snyder coax a young voyager into "The Halley Project."





Dave Lebling — in his own underground empire of "Zork."

Jerry Robinson

looking down our noses, putting down the general public who refuses to 'interact.' Let's blame the forms of interactivity rather than our willingness to do interactivity.

Language

Crawford:

If you create a character inside a computer, then you have to be able to interact with him. The primary way human beings interact with each other is through language. You've got to talk to this person. How are you going to do that? There's an easy answer most people think of: use English. Talk to them in a regular language. Good luck. I can tell you right now you're not going to be able to talk to anybody in a computer in this century. A lot of people grossly underestimate the problems of getting natural language working on a computer. There are three major problems. The first is vocabulary; the second is syntax and the third, context; context is the killer. Vocabulary is a trivial problem. You just take the words, stuff them in memory, no big deal. There are only 600,000 words in the English language — a few megabytes of storage. Trivial. You can do perfectly well with a working vocabulary of 5000 words. You can say almost anything you want to say with the 5000 most commonly used words in the English language. How much storage would that take? A few K, no big deal. OK, second problem — syntax, grammar. You've got to store all the rules of the English language. Again, no big problem. A few years or decades of programming, but that's a solvable problem. You just start writing in the codes for all the weird rules in the English language. It'll take a lot of time, but it's manageable.

The killer is context. You see, language does not exist in isolation from reality. It mirrors reality. A word is not just something that sits in a dictionary or a look-up table in RAM. A word means something. And if you're going to understand its meaning, then you're going to have to understand the universe to which it

refers. Let me give you an example of just how hairy this can get. Consider the following sentence: 'Computer, do not forward John Doe's personnel file to Mary Smith because I saw him sneaking out of her house this morning at 6 am.' Now think about the amount of knowledge you have to have about the world and human behavior to understand what that sentence means. Then think about putting it inside a computer. That's the killer. If you're going to put English inside a computer, you're going to have to put the whole universe in there too. That will take a little while.

Lebling:

How can we do English? That's a good question. We need to figure out how to expand that part of the universe which we simulate. The fallacy is that we have to do everything. There are 600,000 words in English. But even [MIT linguist] Noam Chomsky doesn't know what the grammar of English is. The meanings and the context are incredible, but only if you want to do everything.

But the key is: let's do a bit. A little box somewhere. Let's do that box really well. Then, let's define the boundaries of that box unambiguously so the person who's interacting knows where the boundaries are and doesn't get surprised because he can't wander off into a completely different geography from the one he thinks he's in. Let's just build that box a little bigger every time, get those boxes linked up right, and then we can do as much of the universe as is necessary to make good stories.

The Computer Games Weekend was made possible by generous support from:

David Bunnell, PC World Communications Inc.
Martin "Shag" Graetz
Christopher Morgan
Origin Systems Inc.

Special thanks also to the following:

Addison-Wesley Publishing Company Inc.
Apple Computers Inc.
Cynthia Barker
Bel Canto Restaurants
Michael Bergman
Allison Block, Cabot Public Relations
John Broder, Giardini/Russell
Broderbund Software
Jack Burness
Andrea Coville, Giardini/Russell
Chris Crawford
Paul Dworkin
Electronic Arts
Epyx
Alan Frisbie
Wendy Germain, Germain DRK Inc.
Infocom
The Lafayette Hotel
MacroMind Inc.
Charles Mann
Microprose Software
Mindscape
Sheryl Schultz, Sterling Hager
Stan Schulz
Josh Shapiro, Cabot Public Relations
Sir-Tech Software
Roxanne St. Clair, Hill and Knowlton
Katherine Stimpson
Jeffrey Tarter
Tech Plus Inc.
The Learning Company
Union Office Interiors

Whirlwind's Genesis and Descendants

"Whirlwind's Genesis and Descendants" was the theme of a symposium held at The Computer Museum October 18, 1987. This was part of a weekend reunion of the Whirlwind group organized by David Israel. The symposium was recorded at the Museum and transcribed by Judy Clapp of the MITRE Corporation. Responsibility for the accuracy of the following adaptations of the talks belongs to The Computer Museum.

Whirlwind's Success

Jay Forrester

Jay Forrester is Germeshausen Professor of Management and Director of the Systems Dynamics Group at MIT. He was the leader of the Whirlwind group at MIT from the late forties until 1956.

Why did Whirlwind succeed? Why did more technical innovations out of Whirlwind persist into the present time than from any other of the early computers? The reason revolves around several things: the vision of the future direction of computing, a dedication to excellence, and the organizational environment.

Project Whirlwind's Future Vision

The vision in Whirlwind reached well beyond the uses of computation and hand-calculating machines at that time. Our work quickly became identified with the field of real-time control and reliability.

The dedication to real-time control started well before Whirlwind first operated. In October 1947, when we were still determining the logical structure of the machine, two reports were written in the MIT Computer Laboratory suggesting that the Navy could use digital computers as Combat Information Centers for co-



Jay Forrester, T. K. Finletter, and F. Wheeler Loomis visit the Whirlwind in November, 1951.

ordinating an anti-submarine task force. This meant coordinating the air, the surface, and the subsurface pictures to get an understanding of the totality of what was going on.

Building Reliable Systems

Reliability was important because you can't go back and do things over again in military applications. In 1948, before Whirlwind operated, Karl Compton, then President of MIT and also Chairman of the Research and Development Board, asked that we prepare a memorandum for him on the future use of computers in the military. Bob Everett, Hugh Boyd, Harris Fahnestock and I took two or three weeks to answer that question. The report culminated in a chart listing vertically about twelve wide-ranging areas of computer use in the military, such as logistics, scientific computation, air defense and anti-ballistic missile control. On the other axis were 15 years from 1948 to 1963.

That report is quite an interesting document in historical perspective. At each intersection in each square in the table, we estimated the condition of the field at that time, how much money would be spent yearly in research, engineering and production, and what the condition of the field would be relative to those end uses 15 years into the future. These estimates were made when no high speed general purpose computer had yet functioned.

The estimates are percentage-wise as good as and maybe better than most estimates made today for the time and cost of the next computer to be put into production. This was because we paid a great deal of attention to the political as well as the technological side. The cost estimates were arrived at by subdividing tasks to no more than 30 people working a calendar quarter and by deciding all the things that would have to be done. It was not necessarily correct in detail but

it was a logically complete scenario including how long it would take for people to believe the results of the previous year, and how long it would take to get funding for the next step. The chart showed a total of \$2 billion to be spent in research and development alone over the 15-year period. We went into a Navy conference with this. They thought the agenda involved whether we could have the next \$100,000. There was a communication gap in that meeting.

Dedication to excellence

Many people in the Whirlwind group had had the World War II experience of going from theory through research to production design, then to manufacturing and into the battlefield, fixing their own mistakes at every stage. They understood how the decisions at the research stage really affect what happens later.

In my own early background, I had already started down that road, having grown up on a cattle ranch where you learned that if you did a sloppy job of fixing a tractor or a well, you would suffer the consequences very soon, have to do it over, and do it right. Part of the manifestation of that viewpoint showed up, of course, in our improving vacuum tubes. Until the 1950s, vacuum tubes primarily had been used for radios. Radio engineers were not concerned that the life of a vacuum tube was about 500 hours. But computer engineers, considering the use of many thousands of vacuum tubes, easily estimated that with such a short life, the machine would run no more than a few minutes between failures. One of the achievements of our group was determining the cause of failure of vacuum tubes. It turned out to be one thing. After removing that cause in the design, the life of vacuum tubes was increased, in one design step, from 500 hours to 100,000 hours or longer.

Excellence also meant thorough testing of components. We built a five-digit multiplier for the simple purpose of finding out whether an electronic device running continuously would be trouble-free or not. There was uncertainty about things that people now thoroughly understand.

One important issue was our uncertainty about thermal noise. We didn't know if random spikes of thermally generated noise were big enough to trigger our robust computing circuits. We wondered whether thermal noise would intrude itself often enough to be devastating to accurate computation. To test for this, the five-digit multiplier was run continuously. Every multiplication was checked against a reference number. Sure enough, it didn't compute reliably all the time. It had a great tendency to make mistakes at 3 a.m. This was traced to the janitor in the building next door, who would start the freight elevator at about that time, upsetting the power circuits enough to produce a computation error. As a result, a rotating motor generator with enough inertia to carry through that kind of transient noise was installed on both Whirlwind and the SAGE Air Defense machines. It was an expensive solution but a very effective one.

A lot of time was spent writing test programs to find out the source of a failed component. Occasionally, a visitor was asked to go any place in the computer racks, pull out a vacuum tube and bring it back to the control desk. When he got back, the location of the empty socket would have been typed out by the machine itself. Finding solid, existing, reliable errors, like a tube pulled out of its socket, was not nearly good enough.

Other means of determining reliability were also essential, which we discovered in various ways. I remember one Saturday, during one of many annual reviews, our inquisitor asked, "What are you going to do about the electronic components that are drifting gradually and are on the edge of causing mistakes? Any little random fluctuation in power, or streetcars going by, will cause circuits to sometimes work and sometimes not." This was a very important and powerful question that, frankly, we had done nothing about. It was such a pointed question and obviously such an important one that I felt an immediate answer was essential. I said to him, "Well, we could lower the voltage on a tube and convert it from a marginal to a permanent failure and then it would be easy to find." He thought it was a good solution and so did we, so the next Monday we started designing it into the computer. The marginal checking system in Whirlwind carried over into the SAGE Air Defense system, adding another factor of ten to the reliability.

Many of you may not know the statistics on the SAGE system's reliability. There were 30 or more SAGE Centers. Each building was about 160 feet square, four stories high, with upwards of 60,000 vac-

uum tubes in it. The question is: what percentage of the time do you think such a center would operate reliably? The answers I get from an audience today tend to run from 15% to 60 or 70%. They're really quite overwhelmed when they're told the historical statistics on the SAGE Air Defense system. It was installed in the late 1950s and operated for 25 years, until 1983. According to the data that Bob Everett was able to find, the uptime was 99.8%, which is really quite remarkable. In fact, you will have trouble finding anything equal to that, even when it has been designed with more modern components.

The attitude about the SAGE performance was that it must work reliably. To achieve high reliability, one must be a devout believer in Murphy's Laws — that if anything can go wrong it will. Every possible failure must be identified and forestalled. This attitude is the difference between something that is strikingly successful and disaster. In almost any major disaster, whether a technological or a social one, an ample number of people knew that it was likely to happen and knew in advance why it was going to happen. The information was there, and either they did not take any action, or they tried, and in the social circumstances of their environment, were not able to get any results. A warning is almost always present ahead of the trouble and the problem comes in getting any kind of action or acceptance of the threat.

The Organizational Environment

Another part of the success of the Whirlwind group came from the organizational environment within which we were operating. MIT in those days was a free enterprise society in which someone who had a vision and could raise the money for it could do what he thought was important.

The Leaders

Within our immediate environment, two

people conspicuously stand out as having made it possible for us to operate the way we did. One was Nathaniel (Nat) Sage, Director of the Division of Industrial Cooperation, under which outside funding came into MIT and the other was Gordon S. Brown. In addition, there were two promoters, in the best sense of that word, people who shared the vision and who spent their time building up the outside constituency to support the work. These were Perry Crawford and George Valley.

Sage, a civil engineer by training, was the son of an Army officer and grew up in Army camps around the world. Somewhere in that experience, he developed into a very good and self-confident judge of people. There were people at MIT that he trusted implicitly, and there were others that he wouldn't trust any farther than he could see them. Sage trusted Gordon Brown, Stark Draper, of the Draper Laboratory, and I think I can claim that he trusted me. He had confidence in us, lent great support to us, and would do rather remarkable things for us. I remember when someone chartered an airplane to come back from somewhere because it was a sensible thing to do to get home for the weekend. That caused an explosion in the Military Contracting Office where they thought this was not an appropriate use of funds. The contracting officer went to Nat Sage as the senior person. Sage would listen to them, nod, sympathize with them and say, "That really is too bad." Then he would put the whole thing in his desk drawer. He would never even tell us that the question had been raised, because he believed it probably was a proper thing to do.

Gordon Brown, my mentor at MIT, and director of the Servomechanisms Laboratory under which the Computer Laboratory operated, was a person who threw a great deal of responsibility onto young staff members, even as research assistants in the Electrical Engineering De-

Dr. Gordon S. Brown, who was Director of the Servomechanisms Laboratory, helped create an atmosphere in which the Whirlwind project could succeed.

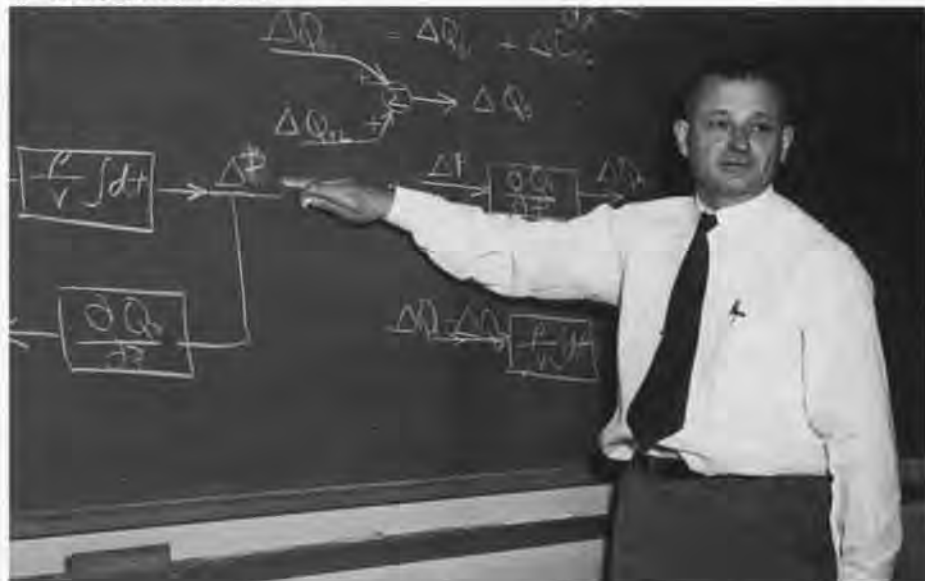

partment. He provided an environment in which people developed very rapidly, and in which they could attach themselves to some important and overriding goal. To him, goes much of the credit for making the environment where the Whirlwind computer project could flourish.

In 1939, Perry Crawford did his MIT Master's thesis on digital computation, which meant developing a ten-stage ring counter to compute with decimal numbers, but never carrying it beyond some individual computing circuits. He is a philosophical, looking-into-the-future type of person. By the time we made contact with him, he was in the Special Devices Center of the Navy in Port Washington, Long Island.

Perry Crawford is the person who first called my attention to the possibility of digital computation. We were standing on the front steps of 77 Massachusetts Avenue one afternoon when we were still working on analog computers in the Servomechanisms Lab. He began to tell me about the work on the Harvard Mark I computer, and about the ENIAC computer which was then under construction. He was a very uninhibited, un-bureaucratic type and would circulate freely right up to the Naval Chief of Operations even though he was a civilian far, far down in the organization. He moved through the Navy selling the idea that digital computers had a future as Combat Information Centers. He had several computer projects under his direction that he raised money for. He is also the person who gave Whirlwind and other projects their names. All of them were named after air movements: Hurricane, Zephyr, Typhoon and Whirlwind.

The other promoter to whom we owe a great deal is George Valley, a professor of physics. He was on a committee of the Air Force looking into air defense. In the later stages of our work that led into



From left to right: Jay Forrester, Norman H. Taylor, John A. O'Brien, Charles L. Corderman, and Norman H. Daggert inspect the open, high voltage Arithmetic and Electrostatic Storage Racks characteristic of computer equipment in the early 1950s.

Lincoln Laboratory, he was the person who would call up generals in the middle of the night, tell them what they should do, and ask for support. He did all those things you read exposés about in books on the politics of technology, but which are necessary to keep the program coordination running smoothly.

The Organization

Sometimes you have people in an organization, each of them with an IQ of 130, and come out with an organization whose IQ is 70. What you get is the least common denominator rather than the best of the participants. I'm not sure how one creates the opposite environment, but there is great power in a tightly knit organization that has the capability of using the strengths of each person and compensating for the weaknesses of each.

Every person has strengths and weaknesses. You need a team in which there are such things as a vision of the future, a sensitivity to political matters, the capability of developing people, technical competence, the courage to transcend adversity, salesmanship, integrity, and putting long-range goals ahead of the short term. We had those characteristics well represented, scattered throughout our group. No person had all of them. For every person there would be, perhaps, a glaring hole in one of those dimensions. Yet, it was a group that understood each other well enough to use people in situations where their strengths prevailed rather than their weaknesses. Out of that came an organization that was able to be much more effective than most of those we see around us in technology and in most corporations at the present time. It is still an unsolved challenge to understand how that sort of spirit and unity can be created.

The Hostile World

Another thing that helped us, but that we resented, was the hostility towards innovation. There was little outside understanding of our subject, the objectives, or the methods for building pioneering computers. Funds were almost always inadequate. Reviews and investigations required us to defend our position and to face the weaknesses that other people were pointing out. We benefited from the distractions caused by the periodic reviews in which everything was questioned. Why were we using so much money? Why were we running late? Why were we designing the machine the way we were?

The matter of cost was one of the things that the outside world understood least. Whirlwind was being judged in the context of mathematical research, in which the salary of a professor and a research assistant was the standard by which projects were measured. We were spending way beyond that level, and

The Whirlwind console room in 1951 with the marginal checking and toggle-switch test control panels on the left. Stephen Dodd, sitting at an input device, is being watched by Jay Forrester and Bob Everett. Ramona Ferenz is seated at the prototype display to monitor the Cape Cod system, the prototype for SAGE.



The MITRE Corporation Archives

were seen as running a "gold-plated operation." Although the gold plating was occasionally excessive, in retrospect, I think there was reason for it.

An organization can't run with two contradictory standards. If you're going to have high performance and high quality in the things that matter, it is very difficult to have low quality and low performance in the things that, perhaps, don't matter. For example, at an early demonstration for important people, we didn't want them sticking their fingers into the high voltage in all those racks of Whirlwind. I asked somebody to get rope to put along the aisles so visitors wouldn't walk among the racks of vacuum tubes. A nice-looking white nylon rope was procured and installed. During the demonstration, I saw some of our critics fingering this beautiful rope and looking at one another knowingly as if to say, "That's what you would expect here." It may not have cost any more than hemp rope, but it reinforced that impression of an extravagant operation. Another example was the Cape Cod display scopes built into plywood cabinets faced with mahogany. Although our cabinetmaker made these quite inexpensively, people looking at those mahogany cabinets, were reinforced in thinking we were extravagant. Eventually we solved this problem by spending additional money and painting the cabinets gray.

Whirlwind's Technology

Making the decision to build Whirlwind I with a 16 binary digit register length was tremendously hard for us. The mathematicians were up in arms. They thought it was too short to be of any possible use. We defended it at that time on the basis that it was a demonstration of feasibility and we would build a 32 or a 36 bit computer when the right time came. Many of today's desktop computers are still 16 bits and only now moving to 32 bits. Selecting 16 bits was not a useless register length for computing, only a serious short term political problem.

The objectives of a computer at that time dominated the kind of high-speed internal memory to be chosen. Since Whirlwind was for demonstrating a very high speed computation for real-time applications, we chose electrostatic storage tubes rather than any of the more reliable kinds of serial memories. Each electrostatic storage tube with 1024 binary digits cost us about \$1000 and had a one month lifetime. That meant that the upkeep on a storage tube, just its replacement, cost about \$1 per binary digit per month. If you were to spend that on your two-megabyte personal computer, it would cost you \$24 million per year just to maintain computer storage. The improvement has been perhaps a million-fold since that time in cost. That's about a factor of two every two years in the intervening 40 years. The high cost of storage tubes was the major incentive for inventing and perfecting coincident-current, random-access magnetic memory.

The economy necessary in programming was quite remarkable by today's standards. We demonstrated a military combat information center with one real bomber, one real fighter, and a radar set to generate data, with the computer receiving radar data by telephone line, analyzing it, throwing away the noise, averaging and smoothing and predicting the track, doing the same for the fighter, computing the intercept heading for the fighter, and then transmitting instructions to the autopilot automatically. If we today asked a programmer how much computer memory would be necessary for such a program, the programmer would probably guess a million bytes, minimum. The task was done on Whirlwind with 650 bytes of memory, not megabytes, just plain bytes. It was a time when the costs favored cutting programs to the minimum and using, if necessary, a lot of time, a lot of manpower, to reduce the programs.

Contributions of Whirlwind

In spite of the sense of extravagant expenditure, the entire Whirlwind project totaled about \$4,500,000. That doesn't seem like much in today's computer world. Out of that came the first parallel, high-speed, clock-driven computer, magnetic core memory, cathode ray tube displays driven by a computer, an interactive light gun connecting a person to the computer, and many other innovations that are still important today.

We thought we had a good view of the future and we did for the succeeding 15 years, but I must say that our view of the future did falter if you were to extend it beyond that time. I gave a talk in the mid-1950s to a computer convention in which I pointed out that the cost of computation had been falling by a factor of

two every two years from 1940 to 1956. I said, "Of course that can't go on for very much longer." But, of course it did, and is still going on.

Becoming a User

After 1956, I went more into the use of computers, using the ideas of feedback systems that Gordon Brown had originally pioneered and applying the methodologies and concepts to understanding the behavior of social systems. My present work is focused on the way in which the policies of a corporation produce its successes and failures and the way in which the policies embedded in the private and governmental sectors produce the behavior of the national economy.

My present work is focused on understanding the so-called economic long wave, the great rise and fall of economic activity with peaks every 45 to 60 years. This behavior has produced the great depressions of the 1830s, the 1890s, and the 1930s. We believe that the present economic cross-currents are the beginnings of another such major downturn. Working on behavior of social and economic systems is now especially timely. Just as the frontier of physical science opened up in the 1800s, the frontier of understanding our social systems now lies immediately ahead.

The Whirlwind project had shown that a reliable real-time computer could be constructed and that aircraft could be tracked and intercepted. Robert Everett is shown here on the Control Force Demonstrator in 1947.



Discovering a "New World" of Computing

Robert R. Everett

Robert R. Everett is the former president of MITRE Corporation.

In 1947, the first work on how to use a general purpose digital computer for tracking aircraft was carried out at MIT. The project accounts for many firsts, because we were the first to ever have those problems. It was like Columbus and his crew discovering a new world. Jay was our Columbus and we discovered many strange and wonderful things. The computer business has grown to be like the original 13 colonies, with a vast, beckoning wilderness we have yet to explore.

The Whirlwind project proved that a real-time computer reliable enough to work could be built and that aircraft could be tracked and intercepted. But translating this experimental knowledge into an operational countrywide system was a major activity. Both technical and "organizational design" were needed.

The Birth of Lincoln Lab

The first step toward SAGE was the formation of Lincoln Laboratory by MIT, where we had a strong organization and excellent experimental verification and demonstrations. When the Air Force decided to go ahead with SAGE, Lincoln Lab was given the technical responsibility. An Air Force project office was set up in New York, supported by Western Electric, Bell Telephone Laboratories played a role in designing tests and criticizing what went on. IBM was chosen to build the central machine and Burroughs, to build some of the radar processors.

Lincoln was able to stay on top of SAGE because the group had done the planning backed by real experiments and demonstrations. Jake Jacobs created a systems office. Coordination meetings were held in which people from dozens of organizations, hundreds of people at a time, would get together. The group from Lincoln defined the problems, defined the options for solving those problems, and proposed decisions. We would present all this, and then eve-

rybody was faced with the option of either agreeing or taking some responsibility to do something else. They never wanted to do the work necessary for a new plan, so we always got our way.

The Role of IBM

The choice of IBM to build the central machine was made by Jay Forrester, with some help from Bob Wieser, Norm Taylor, and me. We visited the possible contractors and chose IBM because it was a very successful organization with strong sales and clean factories.

IBM had a series of machines in production and their own set of strongly held opinions about technology, standards, and organization. In the beginning we said, "This is our business. We know what to do. You are here to manufacture it." They said, "We built computers long before you." We even argued about how to make the frames. They made frames out of square steel. We said, "You don't want to do that, it might rust on the inside and it won't last more than a few thousand years. You ought to use L-shape aluminum like we do." Over time, I think we came to understand each other.

We had to learn about communicating with IBM. Next to my office we put in a Teletype machine to communicate with Poughkeepsie. I arrived in the morning and just stared, fascinated, at this machine. I finally figured out why. I had always looked at Teletype machines or typewriters connected to computers that said dull things like "23" or "fault" or "redo." This machine said, "Good morning, it's a lovely morning in Poughkeepsie."

One lesson, I recall, involved working on the core memory. We built some 32 by 32 bit planes, and we knew we needed bigger ones than those but weren't sure we could handle the nonselect noise. Someone suggested we divide it up into quadrants and put a sense amplifier on each quadrant, which meant four sense amplifiers. Coming back from Poughkeepsie one night, I realized it only took two. I thought, "Wouldn't it be funny if we all died in a car accident and SAGE had four sense amplifiers?" The next morning, I rushed into work ready to tell everybody about the two sense amplifiers. On my desk was a memo from Bill Papian's organization that said, "By the way, you only need two sense amplifiers." You had to be careful not to assume you were the only person who might think of something.

About 200 staff at Lincoln tried to stay on top of the project by turning the jobs over to other people as fast as possible. We didn't have the resources to do the design ourselves. Some of the troops at Lincoln didn't want to give up design because they felt strongly about what they were doing and weren't sure they trusted some "Johnny-come-lately" like IBM or Burroughs to build things properly. Fortu-

nately, IBM wanted to take the job over as much, if not more, than we wanted to get rid of it.

It was a lot more difficult with the software. We had by then written the Cape Cod programs and had some feeling for the difficulty. We tried to get IBM interested in it and they said, "No, we sell equipment." So we tried AT&T who declined. Finally, Systems Development Corporation, spun off from the Rand Corporation, was created for this purpose.

The Air Force Partnership

The software turned out to take thousands of people. Jay set up a recruiting operation, and we hired hundreds of people off the street, unemployed mathematics teachers and so on. The Lincoln group hired hundreds of people for SDC.

Once the Air Force committed itself to building SAGE, they gave us complete support. For example, when we needed more computer time, we just bought it. The problem was that there weren't many computers around. Somebody had the bright idea that the machines in production in Kingston on the test floor were only being run two shifts. We needed time. IBM seemed willing. So we sent one of our fellows to IBM to negotiate it. He returned knowing it would cost a lot of money. Months later, Harris Fahnestock came into my office, white and shaking, with a bill from IBM for a million dollars. I said, "Now don't get flustered, Harris. I know we should have told you, but you would've had to agree with it anyway so why don't you just pry the bill and go away?" And he did. You can't imagine that happening today. We probably all would have gone to jail. The Air Force never complained. They understood. They knew the computer time was needed. They knew it would cost money, and they paid the bill.

The way the Combat Center program was written involved getting Walter Attridge and busloads of SDC programmers to Syracuse, where the center was being put together. They wrote the Combat Center program at the site. Although it was a year late with a big overrun, it worked and worked well.

When the first SAGE center went operational on July 1, 1958, MIT's commitment was over. That fall, MIT spun off their Lincoln Lab SAGE people to MITRE, which has been working on similar problems ever since.

About 20 centers were built. The ICBM put an end to the high priority that air defense has had, but the system ran for quite a while through the early 1980s. When the last centers went down a couple of years ago, they were still running well and reliably.

We had come to the end of the first part of the journey. I went to MITRE and Jay Forrester stayed at MIT. He was our Columbus, the first boss for many of us, the best boss for all of us, the creator of Whirlwind and SAGE, Jay Forrester.

From World War II Radar Systems to SAGE

C. Robert Wieser

C. Robert Wieser is Director of Engineering at Science Applications International Corporation in Newport Beach, CA.

The 1949 detonation of a Soviet nuclear bomb was way ahead of the United States' time schedule for that event. Over night, the requirements for the air defense system changed drastically. The US air defense, patterned on the system used in the Battle of Britain, resulted in a five percent attrition rate for incoming bombers, i.e., 95% of the planes got through. With nuclear weapons, this rate was unacceptable. A chill went through the air of the defense community. Something had to be done. George Valley, Professor of Physics at MIT, understood that the existing system could not just be incrementally improved.

Improving the Radar System

Three major areas of the air defense system were identified that needed changing. The ground control intercept station that got information from a single, large, long-range radar, was dependent on the maintenance of a single station and only worked for aircraft targets at medium or high altitudes. If planes flew at low altitudes, long-range detection was impossible because radar follows line of sight, not the earth's curvature.

The second problem was that all of the processing of the radar data was manual. The detection of aircraft was done by men looking at oscilloscopes. Tracking was done by a grease pencil to mark successive radar blips on the scope. Vectoring instructions were done by approximation, the observer figuring out the right course to get to the right place and assigning a target time. Unreliable high-frequency radio was used to track radar from one station to the next. The time delays in the transmission spoiled matching up the tracks.

Finally, jet aircraft were just being introduced, aggravating the deficiencies of the system. Since the aircraft went much faster, it was harder for an operator to do intercept computations in his head and tell a fighter pilot where to find the target.

George Valley began to search for radically different new ideas needed to solve these problems. The first idea was to substitute commercial telephone lines for high-frequency radio. That was a social innovation because the military believed that its communication system should be completely independent of the communication system used by civilians regardless of their effectiveness.

George found that Jack Harrington, head of research at the Air Force Cambridge Research Center, was working on ways to reduce the bandwidth of radar data so that the radar picture could be transmitted over voice telephone lines. An experimental apparatus was working, hooked up to an old microwave early warning (MEW) radar at the Bedford Airport, now Hanscom Field. George understood that such a system would allow the integration of data from many radars into one network. Hooking radars together, a region the size of New England could be covered, and by including short-range radars that filled in the low altitude gaps, the coverage could be extended down to about 500 feet above the ground. These were powerful new ideas made possible by new technologies.

The next thing that George discovered was the existence of the Whirlwind project. Jay Forrester and Bob Everett told him about their earlier work foreshadowing automatic control. George saw the possibility of automating the radar surveillance data for whole regions of the country.

Real-time Control

At this time, I was working on the first program attempting to apply the digital computer to real-time air traffic control. My bright group of graduate students,

called "Boy's Town," included Dave Israel, Bob Walquist, Jack Arnow, Howard Kirschner, and others. The group was too inexperienced to be overawed by our task. Overnight we converted from air traffic control to air defense.

The group followed an empirical, experimental approach, taking on the real world as fast as we could. Remote radar data came into the Barta building where Whirlwind I was under construction. At the time, Whirlwind had no electrostatic storage. Random access memory was five flip-flop registers and 32 toggle switch registers that could be read by the machine. We got the radar data inserted into the machine and displayed. After this happened we came face-to-face with some problems.

First, radars see a lot of things that aren't airplanes. That tends to load up the transmission system. Second, telephone lines were not perfected for data transmission. For example, dialing clicks came in as false targets. The progress in fixing those problems was very rapid because we didn't have to plead for permission. We just got the job done.

The next big event was when Whirlwind got one bank of electrostatic storage tubes with 256 registers. That was when we began to learn about the romance of computer programming. The word "software" had not been invented at the time. All of the programming was done in machine language because there wasn't anything else. With 256 registers, we extended the capability to simultaneously track-while-scanning ten airplanes. Alternatively, two airplanes could be tracked with vectoring instructions to indicate collision courses.

Preparations began to try the real thing, an interception of two airplanes. We made friends with people in the Air National Guard and persuaded one pilot,

From left to right: C. R. Wieser, Bob Everett, and Jay Forrester gather at Forrester's retirement party in June, 1956.



The MITRE Corporation Archives



The MIT Museum

On January 16, 1956, the SAGE system of continental air defense was introduced to the press at Lincoln Laboratory. From left to right: Edward L. Cochrane, Vice President for Industrial and Governmental Relations; George E. Valley, Jr., Associate Director of Lincoln Lab; Major General Raymond Maude; Colonel D.E. Newton, Jr., Commander and Vice-Commander, respectively, of Air Force Cambridge Research Center.

who was flying a small twin-engine Beechcraft to be the target. Another pilot with a T-6, single piston pilot trainer, was asked to be the interceptor. To run the system, we had to communicate with the interceptor pilot and pass the computed instructions to him by voice telephone. That was Howard Kirschner's job. With no digital displays on the computer, Howard, with the wonderful wiring in his brain, could read the indicator lights off the registers, convert them to decimal, and send instructions to the pilot. In April, 1951, we ran the first successful interception. The T-6 came within a thousand feet of the C-45. The impact of this accomplishment was so powerful that, three days later, the decision was made to build the Cape Cod System.

The Cape Cod System

This functional prototype of the air defense system was to be based on digital computation and remote transmission of radar data. Since it would be inappropriate to copy the hardware, Cape Cod was a functional prototype to test all the ideas for replication. Furthermore, it was a demonstration to ourselves, our friends, our skeptics, and our adversaries that this was more than intellectual nonsense.

The specifications for the Cape Cod System included doing air surveillance, automatically generating tracks, following the tracks, and generating vectoring instructions to interceptors. A group of Air Force enlisted men and officers were to carry out the project in two and a half years, from the spring of 1951 to the fall of 1953.

The system was completed on time with full functionality. Many engineering difficulties were encountered in building the pieces and putting them together because it was a new concept, made from new equipment, and new technology. Toward the end of the test period, the first core memory storage was installed on Whirlwind. The system went

from 256 registers to several thousand, and the reliability was vastly improved.

In 1954, the system was expanded by increasing the radar network. The radars were located in Brunswick, Maine, Truro, Massachusetts, and Montauk Point, New York, and the interceptors included aircraft at Hanscom Field, bases on Long Island, and south of New York. Live exercises were run diverting Strategic Air Command bombers that were used as targets. Everything worked. A new development was the automatic ground-air data link so that Howard Kirschner did not have to read all those lights on the computer. It also foreshadowed the coming of missiles like the Bomarc which had no pilot.

The first ground-air data link experiments were interesting. Doc Draper of the Instrumentation Lab had a light test facility out at one end of Hanscom Field. Chip Collins, his chief pilot, discovered that one of the aircraft, a World War II B-26, Martin Marauder, had an autopilot that could take digital input. The radio frequencies were set up to send vectoring instructions directly to the autopilot. On the test we heard Chip Collins say, "Let George do it," which meant switch to autopilot. A little while later, when we traced it on the scopes, he said, "Tallyho," as he sighted the target. Someone dubbed that "The Immaculate Interception."

With today's DOD guidelines, no such experiment could be carried out. In two and a half years, we wouldn't have been able to agree on an operational requirement, get an acquisition plan together, set up the RFP, the Source Evaluation Board, the Source Evaluation Advisory Council, the Source Evaluation Executive, and all the other groups, and still negotiate a DOD contract. At that time, we just did the job that was expected of us.

From Cape Cod to SAGE

The decision to build the SAGE System did not fall out of building and demonstrating the Cape Cod System. Competing schemes existed and there was a lot of missionary work to do to get our ideas accepted.

The burden of selling "electro-theology" fell on Jay Forrester and George Valley. Jay commissioned us to write Technical Note 20, a master plan for the development and installation of the "Lincoln Transition System." (The name "SAGE" had not yet been invented. George Valley brought in General Gordon Saville of the Air Force. He was about five and a half feet tall, feisty, had a strong voice and understood his own opinions. After he read TN 20, he came back, went to the head of the table, threw it down and said, "You're the worst damn salesman I ever met. This report is stinko profundo. What you ought to do is start all over again, and maybe if you worked real hard, you might work your way up to medium sorry." We listened to him carefully and began to understand that it's one thing to explain something that lies outside a person's experience and yet another thing to explain something that lies outside his imagination. The latter is much harder, but it has to be done.

A Once-in-a-Life Experience

Sometimes I ask myself why this was such an interesting experience, the like of which I haven't had since. There are a couple of reasons. We were saved from the day-to-day frustrations of butting heads with the bureaucracy. We could invest all of our engineering skills in the task we had to do.

An important reason is that we had the engineer's dream: a nationally important problem that was interesting and difficult but not impossible to solve. These are the best kind. We were in a day-to-day contest with Mother Nature. The odds were bad, but we always had a chance to win, and we won all the battles that led up to SAGE. We also won the cause for digital computation. If there's anyone who thinks we didn't win, just go to Radio Shack and try to buy an analog computer.

**March 6
Sunday
3 PM** **Beyond Nature: Computer Graphic Simulations of Life**
Peter Oppenheimer of The Computer Graphics Laboratory, New York Institute of Technology, will introduce and discuss his computer-generated experiments that create surreal forms of life captured on video.

**March 13
Sunday
3 PM** **Intelligent Machines of Today and Tomorrow**
Raymond Kurzweil, inventor of a reading machine for the blind and other computer-based devices, will talk about artificial intelligence and introduce the special film the Kurzweil Foundation produced, "The Age of Intelligent Machines."

**March 19
and 20
Sat. and
Sunday
12:30 and
3:00 PM** **SIGGRAPH Electronic Theatre 1987 Part 1**
Four showings over the weekend of the edited tapes from SIGGRAPH 1987 with commentary by an authority. SIGGRAPH sponsors the annual "Academy Awards" for the international computer graphics community.

**March 26
and 27
Sat. and
Sunday
12:30 and
3:00 PM** **SIGGRAPH Electronic Theatre 1987 Part 2**
Four showings over the weekend of the edited tapes from SIGGRAPH 1987 with commentary by an authority.

**April 1-30
10 AM-
5 PM** **Awesome Adventures**
As part of Boston's Museum Goers Month, The Computer Museum presents a month-long interactive exhibit of such "awesome adventures" as maze exploration, flight simulation and 3-D animation.

The Computer Museum

The Computer Museum is a non-profit 501(c)3 foundation that chronicles the evolution of information processing through exhibitions, archives, publications, research and programs.

Museum Hours:

Summer: Open daily 10 - 5, Friday 10 - 9. *Winter:* Open Tuesday - Sunday 10 - 5, Friday 10 - 9. Open Mondays during Boston school vacation weeks, 10 - 5. Closed Thanksgiving, Christmas, and New Years Day. Hours are subject to change.

Staff

Joseph F. Cashen, *Executive Director*
Dr. Gwen Bell, *Founding President*
Dr. Oliver Strimpel, *Curator*
Dan Griscom, *Exhibits Engineer*
David Havlick, *Exhibits Assistant*
Tom Merrill, *Exhibits Technician*
Lynn Hall, *Collections Manager/Registrar*
Mark Hunt, *Marketing Director*
Jonathon Brent, *Store Clerk*
Michael Chertok, *Educational Coordinator*
Robert Gates, *Assistant Store Manager*
Laura Goodman, *Store Manager*
Linda Holekamp, *Communications Assistant*
Gail Jennes, *Public Relations Manager*
Kathy Keough, *Functions Manager*
Pam Lyons, *Weekend Store Manager*

Michael N. Oleksiw II, *Development Director*
Toni Dunham, *Membership Coordinator*
Scott Relly, *Development Coordinator*

Mark R. Allio, *Director of Finance and Administration*
Nancy Heuchert, *Staff Assistant*
Brian McLaughlin, *Accountant*
Gregory Schroeder, *Operations Manager*

Interpreters

John Bristow, George Kloury, Arthur Krause, Thomas Restivo, David Schaffer (floor managers); Jane Ewing, Mehreen Hassan, John Mello, Norman Simpson, Carlton Soberanis, Stephen Wilson.

Public Relations Committee

Cabot Public Relations
Geithner/McGowan
Germain/DRK
GR PR, Inc.
Hill and Knowlton
Sterling Hager, Inc.

Advertising Consultant

Abbot Ames Advertising

Designer

Michael Sand, Inc.

Become a Computer Museum Member

YES! I want to become a Member of The Computer Museum.

\$20 Student \$ 45 Family \$250 Sponsor
 \$30 Individual \$100 Donor \$500 Patron

Members receive free admission for one full year, invitations to exhibit previews, advance notice of exhibitions and lectures, invitations to members-only events, a subscription to our quarterly magazine, The Computer Museum Report, and a 10% discount in the Museum Store.

Enclosed is my check made payable to **The Computer Museum** for \$ _____

or charge to: VISA MasterCard American Express

Card # _____ Expiration Date _____

Signature _____

Name _____

Address _____

City _____ State _____ Zip _____

Mail to: Membership Coordinator at The Computer Museum, 300 Congress Street, Boston, MA 02210.

The End Bit

000000000000000001

Computer Space was the first coin-operated video game. It was developed by Nolan Bushnell in 1971. While "Computer Space" was a modest failure and only sold about 2,000 units, Bushnell's next game, "Pong," was a tremendous hit that ushered in the era of video arcades and home game machines.

Produced while Bushnell was with Nutting Associates, the "Computer Space" flyer describes the game's "BEAUTIFUL SPACE-AGE CABINET" and "the reality of controlling your own rocket ship in gravity-free outer space." In fact, "Computer Space" was very near "Spacewar!" in terms of the action that it offered. The game's original instructions conclude with the offer, "If I can help answer any question concerning this machine, please do not hesitate to call me personally. Nolan K. Bushnell, Chief Engineer, Nutting Associates, Inc." The following year, 1972, Bushnell started a game company of his own — Atari.



NA-2010

This photo is from the game's advertising and instruction brochure printed in 1971. It was donated to The Computer Museum by Alan Frisbie.

Address Correction Requested

Non-Profit
Organization
U.S. Postage
PAID
PERMIT NO. 110
FITCHBURG, MA
01420





the
computer
museum

MEMORANDUM

Annual Report

A Salute to Our Supporters

We are grateful to all who provided support this year.

Program Support**\$100,000 and above**

Digital Equipment Corporation
National Science Foundation
A. Neil Pappalardo

\$50,000 and above

Goldman, Sachs & Company
Kapor Family Foundation
Massachusetts Cultural Council
Mellon Trust
Sun Microsystems

\$5,000 and above

Andersen Consulting
Hybridon
Symantec Corporation

\$1,500 and above

Charles River Ventures
Mitsubishi Electric ITA
Netscape Communications Corporation

The Computer Clubhouse

American Express Foundation
Argosy Family Foundation
Reebok Foundation
Bell Atlantic
Boston Gas/ServiceEdge Partners
Peter F. Drucker Foundation
DeWitt Wallace-Reader's Digest Fund
The Boston Foundation
Boston Globe Foundation
Kelvin F. Cross
The Gillette Company
Massachusetts Cultural Council
The Millipore Foundation
State Street Foundation
Shirley Resnick
Anna B. Stearns Foundation

Stride Rite Charitable Foundation

TJX Foundation

Robert Treat Paine Association

Corporate Members and Supporters**\$10,000 and above**

Adaptec
BankBoston*
IEEE Computer Society
Medical Information Technology
Microsoft Corporation
Sun Microsystems Laboratories
The Weber Group
Unisys Corporation

\$5,000 and above

Adobe Systems
Bay Networks
Bell Atlantic
CMP Media
Compaq Computer Corporation
IBM/Lotus Development Corporation
International Data Group
MathSoft
The MathWorks
Mellon Trust
National Semiconductor
PricewaterhouseCoopers, LLP*
Stratus Computer
Symantec Corporation

\$3,000 and above

Advanced Micro Devices
American Power Conversion
Boston Edison Company
Canadian National Railways
The Gillette Company
Inso Corporation
MCI Telecommunications
Mitsubishi ITA
Parametric Technology Corporation
Pegasystems
Raytheon Company

The Research Board
Ropes & Gray*
Thomson Financial Services
U.S. Postal Service

\$1,000 and above

Advanced Technology Ventures
Alpha Industries
Analog Devices
Andersen Consulting*
Applied Technology Investors
Aspen Technology
Automatic Data Processing
BBN Corporation
Cabot Corporation
Charles River Ventures
C.S. Draper Laboratory
Choate, Hall & Stewart*
Chubb & Son*
Computervision
Cunningham Communication
Dataware Technologies
Deloitte & Touche LLP
DiaLogos
Dow Chemical Company
EMC Corporation*
Ernst & Young
Fleet Bank
Global Competitiveness Corporation
Greylock Management Corporation
GTE Laboratories
Harcourt General Charitable Foundation
Hewlett-Packard
Hill & Barlow
Houghton Mifflin Company
Intermetrics
Loomis, Sayles & Company, LP
Mangosoft Corporation
McGraw-Hill Companies
Mercury Computer Systems
Miller Shandwick Technologies
The Millipore Foundation
Moreira Consulting

Motorola ISG
Nagler, Robins & Poe
Network General
New England Financial
Oak Industries
Parlance Corporation
Performance Motion Devices
Quantum Corporation
Robertson Stephens
Shiva Corporation
Silicon Valley Bank*
State Street Bank & Trust
Sterling Hager
SWIFT
Sybase
Teradyne
Trust Insurance Company
Volvo Group North America
Wolfram Research
World Trade Center
XRE Corporation

\$500 and above

Boston Gas Company
Concept Five Technologies
Feinstein Kean Partners
Wyman-Gordon Company
**Breakfast Seminar Series Sponsor*

Friends of the Museum**\$10,000 and above**

Lynda Schubert Bodman
Richard and Nonnie Burnes
Robert Davoli and Eileen McDonagh
Paul and Joanne Egerman
Gardner C. Hendrie and Karen Johansen
David House
Mitchell Kapor
David and Pat Collins Nelson
A. Neil and Jane Pappalardo
Paul and Kathleen Severino
Leonard J. Shustek
Larry and Dawn Weber

\$5,000 and above

Anonymous
Richard and Virginia Case
Kelvin F. Cross
Burgess Jamieson
Laura and Ken Morse
Benjamin and Maureen Robelen
Howard Salwen
F. Grant and Dorrit Saviers
Michael Simmons
Lee and Bob Sproull

\$2,500 and above

Albert Aiello, Jr.
Richard and Judy Anders
Erich and Renee Bloch
Vinton and Sigrid Cerf
William Foster
Terri Holbrooke
John Mashey and Angela Hey
Jim and Stephanie Nisbet
Dan Schwinn
Susan Sereno and Juan Collas
Dorothy A. Terrell and Albert H. Brown
Ann Winblad

\$1,000 and above

Sam Albert
David L. Anderson
Charles and Constance Bachman
Carol Bartz
Edward Belove and Laura Roberts
Jeff Braun
Rod Canion
Richard and Elizabeth Carpenter
Arthur and Virginia Carr
Robert and Elizabeth Charpie
Steve and Maureen Chehey
Howard E. Cox, Jr.
Stephen Crosby and Helen Streider
Brian Cullinan
John and Agnes Cullinane
Andrea Cunningham
David Cutler and Deborah Girdler

\$1,000 and above (continued)

Jean and Sylvia deValpine
 Mr. and Mrs. Charles Digate
 Tom Franklin and Leonie Gordon
 Robert Frankston and Eleanor Elkin
 Sam and Carol Fuller
 Gideon I. Gartner
 Alain and Carol Hanover
 Christine Hughes
 Theodore Johnson
 John and Linda Loewenberg
 Carl and Wilma Machover
 David Mahoney
 John and Catherine Mandile
 Barry W. Margolin
 Howard and Colleen Messing
 Isaac and Ronee Nassi
 Barry and Catherine Nearhos
 Katherine C. Patterson
 Paul R. Pierce
 Shirley Resnick
 Fontaine and Judy Richardson
 Dennis Ritchie
 William and Judy Seifert
 Richard Shaffer
 Hal B. Shear
 John F. Shoch
 Irwin J. Sitkin
 Max and Nancy Steinmann
 Joel D. Sugg
 Rich and Cindy Tennant
 Gary and Janet Vacon
 Eliot and Louisa Vestner
 Allan and Nadine Wallack
 William Wulf and Anita Jones
 The late Charles Zraket and Shirley Zraket

Annual Supporters, \$500 and above

Howard and Holley Cannon
 John G. Carberry
 Walter M. Carlson
 William and Vicki Christensen
 Randall Davis
 Nick and Margaret DeWolf
 Peter and Kate DeWolf
 Lucien and Catherine Dimino

William T. Elliott
 Andrew and Sarah Feit
 Barry James Folsom
 Ernest and Elizabeth Jennes
 Gail A. Jennes
 Jeffrey and Marlene Kalb
 John and Marilyn Keane
 Mike and Kathleen LeRoy
 John N. Little
 Joseph C. Morris
 Deborah Owen
 James N. Porter
 Robert W. Puffer and Jane Wilson
 Mitchel Resnick
 Douglas and Patricia Ross
 Michael J. Samek
 Jean E. Sammet
 Ralph Savir
 Oliver and Harriet Strimpel
 Lawrence Tesler
 Michael and Marcella Thompson
 Harvey W. Wiggins, Jr.

\$250 and above

Art and Betty Bardige, Jim and Roberta Bell,
 Leo L. Beranek, Richard J. Clayton, Ed
 Council, Donald and Edith Daykin, Lloyd and
 Eleanor Dickman, John Esbin, Bob and Maria
 Evans, Robert and Ann Everett, Craig and
 Alison Fields, William Gallagher Associates,
 Donald A. Gaubatz, Chad and Anne Gifford,
 Robert and Deanne Glorioso, Stewart and
 Constance Greenfield Foundation, Steve and
 Terry Golson, Robert and Marion Grimm,
 Theodore A. Hess, Jr., Winston and Sarah
 Hindle, Robert B. Hoffman, David and Jane
 Hubbard, Steve Keane, Richard H. King,
 Arnold and Gail Kraft, Thomas E. Kurtz, Faith
 E. Lamprey, Richard Lary, Jon and Judith
 Liebman, John and Elizabeth Little, Arthur
 Luehrmann, Thomas and Carol Marlowe,
 Melvin J. Mason, Jr., Richard McCluskey, Tron
 McConnell, Todd Medlock, Charles and Kathy
 Minter, Arthur H. Nelson, Bernard J.
 Nordmann, Northbridge PTA, Ocean Software
 Services, Ltd., Anthony and Marilyn Oettinger,

Paul Pangaro, David and Linda Patterson,
 James R. Payne, Edward and Rhonda Perkins,
 Ellen Poss, Duane A. Rice, Rita Sepowitz Saltz,
 Sarah Schiermeyer, Benn L. Schreiber, W. Lee
 Shevel, Ellen and D. Bradford Spear, Robert
 and Jean Spencer, Robert and Diane Stewart,
 Juliet Sutherland and Jay Koven, Warren and
 Jane Tisdale, Robert Trudel and Thanh Vu,
 Ralph O. Weber, Fiona and Rob Wilson,
 Michael and Joann Witman

\$100 and above

Ken R. Adcock, Walter and Olga Attridge,
 John E. Bagalay, Jr., Donald L. Baker, Mario R.
 Barbacci, Russell and Jacqueline Barbour, John
 Barstow and Eugenia Ware, Walter and Lillian
 Bateman, Jeffrey F. Berg and Debra H. Paget,
 Robert Blake, Jr., Joshua Boger, David Bonner,
 Mr. and Mrs. M.W. Bouwensch, Boston
 University, Brown University, Bruce G.
 Buchanan, Nancy and Bill Carter, Laurence
 and Ann Chait, George and Judy Chamberlain,
 Richard and Beverly Charlton, Judith Clapp,
 William L. Cohagan, Daniel and Sandra
 Cohen, Clement Cole and Margaret Marshall,
 John and Nichola Collins, Mr. and Mrs.
 William H. Congleton, Fernando J. Corbato,
 Michael Cronin, Mary J. Culnan, Philip and
 Pamela Curtis, Edward and Kathy Czeck,
 Charles Dana, Dr. and Mrs. Barry A. Davidson,
 Thomas A. DeFanti, John L. Delgado, Jack B.
 Dennis, Michael L. Dertouzos, Ray Duncan,
 Richard Dwyer, Joseph J. Eachus, Susan
 Erickson and Bruce Phillips, Robert and
 Jacqueline Fano, Andrew and Joan Farber,
 FAYFOTO, Michael and Barbara Feldstein,
 Ronald Fisher, Tom and Carla Fortmann,
 Myron Fox, Steven and Wendy Frank, Daniel
 Freedman, Joyce Friedman, RoseMary and
 Daniel Fuss, Bernard and Enid Galler, Paul D.
 Garmon, G. Gervaise, Bruce Gilchrist, George
 and Cornelia Gilder, Paul L. Gomory, Jr., S.
 William and Jacqueline Gouse, Paul and
 Martha Green, John J. Guarrera, Richard H.
 Gumpertz, John and Cynthia Haldeman,
 Cynthia Hamlin, Jim and Karen Hayes, Frank

and Jane Heart, David and Marilyn Heebner,
 Anthony Helies, William Hoffman, Charles
 Hood, Thomas P. Hughes, Allan Hurst, John
 Ippolito, Nolan and Joan Jones, Ann Karpick,
 Richard Kenner, Gary and Carol Kessler,
 Joseph W. Knoch, Alan Kotok, Terry Kwan,
 Bernard and Ronni Lacroute, Bruce and Sandra
 Laskin, Sheldon Laube and Nancy Engel, Carol
 LeBlanc, David Leinweber, John R. Levine,
 Joshua Levine, Joyce Currie Little, Kirk M.
 Loevner, Anne Lovett and Steven Woodsum,
 Carl and Claudia Lowenstein, Herman
 Luttermann, Toni Mansfield, Craig J. Mathias,
 Victoria C. Mattscheck, Thomas and Emily
 McClintock, F. Warren and Karen McFarlan,
 John E. McNamara, Medallion Enterprises,
 R.W. Meister, Mitretek Systems, George
 Miyashiro, Moco, Robert Moe, Thomas H.
 Moog, New England Pension Consultants, Carl
 A. Niehaus, David C. Noderer, Landon Curt
 Noll, David Novak, Miah Shull Olmsted,
 Monty Peters, Ernie Petrides, Michael Pique,
 Joyce Plotkin, Jonathan Postel, Practical
 Solutions, Vickie Prescott, Randall M. Presuhn,
 Peter and Peggy Preuss, John and Helen
 Quilty, David and Katherine Ragone, Marvin
 and Sheri Rasmussen, David and Jessica Reed,
 Stephen Reilly, Audrey R. Reith, Herbert
 Richman, William Ricker, C. Mike Riggle,
 Robert and Rosalie Rosin, Kenneth and Alison
 Ross, Jonathan Rotenberg, Stephanie M.
 Rousset, P. B. Schechter, Michael Sedita, Aaron
 and Ruth Seidman, Vijay Shah and Company,
 Daniel and Karen Walker Siewiorek, Linda C.
 Smith, Frank and Betsey Solensky, Karen
 Sollins, David and Joan Solomon, Lillian and
 Richard Sparacino, David G. Strachan, David
 Tarabar, Joseph and Cynthia Thompson, Erwin
 and Adelle Tomash, Frederick and Nomi
 Trapnell, G. Michael Uhler and Laurie Lee,
 Richard M. Van Slyke, Willis H. Ware, Robert
 and Ann Wells, Eric Wermé, Christopher G.
 Westbury, Gary and La Donna Wicklund,
 Thomas Worthen, Joan Blout Wylie, Zentrum
 Fur Kunst ZKM

Matching Gifts Companies

Autodesk, Bay Networks, Computer
 Associates International, General Mills
 Foundation, Hoechst Celanese, IBM
 Corporation, Lucent Technologies, Microsoft
 Corporation, Pfizer, Sun Microsystems
 Foundation, United Technologies

Donors to**Charles Zraket Memorial Fund**

Alpha Industries, Chris and Renee Argyris
 and Family, Jack and Norma Arnow, Ruth
 Helen Banghart, BankBoston, Walter and
 Lillian Bateman, Mary Ann Bedick, Larry
 Belvin, Boston Edison, Paul and Arlene
 Breen, Elrita and Russell Callahan, Richard
 and Beverly Charlton, Dr. Robert and
 Elizabeth Charpie, Concept Five
 Technologies, Dr. Barry and Mrs. Davidson,
 Thomas and Blanche Duff, Robert and Ann
 Everett, Chad and Anne Gifford, S. William
 and Jacqueline Gouse, David and Marilyn
 Heebner, Jim Henderson and Mary
 Pulvermacher, Lawrence and Martha
 Holmes, Steven B. Lipner, John Paul III and
 Margaret Locher, Holly Magna, Medallion
 Enterprises, LLC, Mitretek Systems, Joseph
 and Gail Monayer, New England Pension
 Consultants, Pfizer, Fan Lucy Pope, John
 and Helen Quilty, David and Katherine
 Ragone, Elizabeth and John Ronayne,
 Steven and Ellen Freeman Roth, Shirley
 Rouleau and Family, Alan Salisbury, Vijay
 Shah and Company, Alan and Barbara
 Shoolman, Maria Stokes, Bruce and Sandra
 Tuthill, Eliot and Louisa Vestner, Volvo
 Group, North America, Isadore and Marilyn
 Wasserman, Glen and Lynn Wegner,
 Wyman- Gordon Company.

In-Kind Gifts**\$25,000 and above**

Ames Research Center
 NASA's Center for Excellence for
 Information Technology
 Bay Networks
 Diamond Multimedia Systems
 Digital Equipment Corporation
Forbes Magazine
Info World
Information Week
Interactive Week
 M.I.T.
 Mitsubishi Electronics America
PC Computing
PC Magazine
PC Week
 SONY
 Volition Cabling Systems from 3M

\$10,000 and above

Arnold Communications
 Bose Corporation
 BYTE Magazine
 CIO
Computer Reseller News
 DBMS
Dr. Dobbs
Internet World
 Microsoft Corporation
 MicroTouch Systems
Network Magazine
Network VAR
Software Magazine
 Stewart Filmscreens Corporation
Windows Sources

\$5,000 and above

ACM Communications
 Bingham Dana, LLP
 CyberSparks
Database Programming & Design
 Eastern Rainbow
 Electronic Imaging Center
 IBM/Lotus Development Corporation
Mac Home Journal

Marketing Computers

Maxell Corporation
Microsoft Systems Journal
 NEC
Performance Computing
Software Development
Technology Review

\$1,000 and above

Adobe Systems
 auto.des.sys
 Barbizon Lights of New England
Boston Software Newspaper
 Boston Marriott Copley Place
Chicago Software Newspaper
 Claris Corporation
 Craig Orsini Studios
 Image Marketing
 John Harvard's Brew House
 Legal Sea Foods
 Macromedia
 Motorola ISG
New York Software Newspaper
 North East Brewing Company
 OpCode Systems
 Primesource Corporation
 Racore
 Symantec
 Xeikon Corporation

\$500 and above

Autodesk
 Le Boulanger
 Creative Gourmet
 Creative Interactive
Game Developer
 Harmonix Software
 Lighthouse
 Lightscape Technologies
 Mindseye Technologies
 Ocean Spray

\$100 and above

Grande Concessions, Rossini's, Sebastian's

History Center**Capital Donors**

Gordon and Gwen Bell
 John R. Mashey and Angela M. Hey
 Len Shustek
 Curt Widdoes

Lead Founding Corporate Members

Network Associates
 Oracle Corporation
 Real 3D

Lead Founding Members

Gene and Marian Amdahl
 Edward Belove and Laura Roberts
 Elwyn Berlekamp
 Jeff and MacKenzie Bezos
 Richard and Nonnie Burnes
 Cunningham Communication
 John and Ann Doerr
 Roger L. Evans
 Federico and Elvia Faggin
 Ed Frank, Sarah Ratchye and Family
 John and Patricia Grillos
 Jim Guzy
 Elaine and Eric Hahn
 Roy and Virginia Harrington
 Trip and Lisa Hawkins
 Gardner C. Hendrie and Karen Johansen
 Christine Hughes
 Interval Research Corporation
 Mitchell Kapur
 Harold R. Kellman
 Vinod and Neeru Khosla
 Steven and Michele Kirsch Fund
 Bill and Gay Krause
 Richard Lowenthal
 William D. Mensch, Jr.
 Nathan Myhrvold
 Jim and Stephanie Nisbet
 Max Palevsky
 Suhas Patil
 Bernard L. Peuto
 Disk/Trend, Inc.
 Arthur Rock

Harry and Carol Saal
 Grant and Dorrit Saviers
 Michael Simmons
 Jay M. and Arlene B. Tenenbaum
 Ann Winblad
 Pierluigi Zappacosta and Enrica D'Ettorre

Founding Members

Aaron Marcus and Associates, Inc., The
 Agarwal Foundation, Michael Albaugh, Allan
 and Katie Alcorn, Frances E. Allen, David L.
 Anderson, Paul Armer, ASCII Corporation,
 Dennis and Janet Austin, Dave and Madalyn
 Babcock, Tim Bajarin, John and Sheila Banning,
 Craig and Barbara Barrett, Carol
 A. Bartz, Charlie Bass, Brian A. Berg-Berg
 Software Design, Paul Bergevin, Lyle P. Bickley,
 Maurice and Mary Sue Bizzarri, Eric and
 Renee Bloch, Barry Boehm, Gary Boone-
 Micromethods, Steve and Jane Bourne, Michael
 and Leslie Braun, Howard Bromberg, J. Reese
 Brown, Jr., Owen Brown, Jack Burness, Dennis
 Lee Carter, Ned Chapin, George E. Comstock,
 Cooper Interaction Design, Steve Crocker,
 Yogen and Peggy Dalal, Peter and Dorothy
 Denning, Lloyd Dickman, Whitfield Diffie and
 Mary Lynn Fischer, David R. Ditzel, Daniel
 Drake, Donna Dubinsky, Les Earnest, John R.
 Ehrman, Gordon Eubanks, Jr., Douglas
 Fairbairn, Irwin Federman, Ed Feigenbaum and
 Penny Nii, Roger C. Ferguson, Bob Frankston,
 John R. Galloway, Jr., Katrina and Terry
 Garnett, Donald A. Gaubatz, Charles and
 Nancy Geschke, Ralph Gorin, Martin and
 Selma Graham, Layne Gray, John C. Greene, Jr.,
 Forrest E. Gunnison, David B. Gustavson, John
 Hall and Rebecca Derrington, Lorraine Hariton
 and Stephen Weyl, John and Andrea Hennessy,
 Andy Hertzfeld, Stephen E. Hill, Shuji Honjo,
 Colin Hunter and Alexia Gilmore, The Ignite
 Group, IEEE Computer Society-SCV Chapter,
 Sellam Ismail, Jacque and John Jarve, Jerry A.
 Klein, Leonard and Stella Kleinrock, Don and
 Jill Knuth, Mr. and Mrs. David A. Lane, Cecilia
 A. Larsen, Richard and Ellen Lary, Gary and
 Laura Lauder, Harold "Bud" Lawson, Marc and

Marian LeBrun, Arthur E. Lemay and Joan
 Rogers, Ted G. Lewis, Don and Alice Loughry,
 Carl D. Lowenstein, Tom Lyon and JoAnn
 Kahn, Robert and Katherine Maxfield, Frank
 McConnell, Patrick and Lore McGovern, Carver
 Mead and Barbara Smith, Tom Melcher, Avram
 Miller, Glen and Cathy Miranker, Neal Mitchell,
 Morgridge Foundation, Lee J. Neil, Hal Nissley,
 Landon Curt Noll, The Noyce Foundation,
 Susan Nycum and George Bosworth, Mike
 Park, David and Linda Patterson, Charles
 Pfeifferkorn, Christopher Poda, William A.
 Porter, William and Rochelle Pratt, Rex Rice,
 John Phillip Riganti, Robertson Stephens, David
 J. Rossetti, Lynn and George Rossmann, Jon
 Rubinstein, Jean E. Sammet, Peter R. Samson,
 Allen Samuels, John and Christine Sanguinetti,
 Morey and Barbara Schapira, Ted Selker and
 Ellen Shay, John Sewell, Michael J. Skok, Alan
 Jay Smith, Alvy Ray Smith, Robert and Verna
 Spinrad, George Sptx, Skip and Leilani Stritter,
 Bob Supnik, Richard Swan and Claudia
 Mazetti, Edward A. Taft, Steve Teicher and
 Del Thorndike, Larry Tesler, Geoffrey O.
 Thompson, Mochio Umeda, University of
 Minnesota-Computer Science Department,
 William M. VanCleave, Amos and Ruth
 Wilnai, James and Rosie Wong, Lowell Wood,
 Jean and Bill Worley, William Wulf and Anita
 Jones, Peter and Cindy Zeibelman, John and
 Mary Zolnowsky

Members

Doug Coward, David DiNucci, Joseph Paul
 Fredrick, Amos and Marilyn Goldhaber,
 Norman Hardy, Kevin Hogan, Gail Jennes,
 Suzanne Johnson, Ted Kaehler, David Lichtman,
 Dru Nelson, Edgar Nielsen, Michael Pique,
 Heidi Roizen, Alison and Ken Ross, Roy L.
 Russo, Robert Sherwood, David C. Smith,
 Joseph M. Smith, Ellen Spertus and Keith
 Golden, Tom Stepleton, Duane K. Wise

We apologize for any inadvertent omissions from our donor list. Please inform us of any errors so that we may correct our records.

Board of Trustees**Chairman**

Lawrence Weber
The Weber Group

Vice Chairman

Paul Egerman

Treasurer

Barry Nearhos
PricewaterhouseCoopers, LLP

Clerk

J. Thomas Franklin, Esq.
Lucash, Gesmer, Updegrove, LLP

Acting Executive Director

Ellen Spear
The Computer Museum

Lynda Schubert Bodman

Schubert Associates, Inc

Richard M. Burnes, Jr.

Charles River Ventures

Samuel Fuller

Analog Devices

Gardner C. Hendrie

Sigma Partners

David L. House

Nortel Networks

Christine G. Hughes

Secure Computing Corporation

A. Neil Pappalardo

Meditech

Anthony D. Pell

Rochdale Investment Management

Mitchel Resnick

Massachusetts Institute of Technology

Leonard J. Shustek

Network Associates

Lee S. Sproull

Boston University

Dorothy A. Terrell

Natural Microsystems Corporation

Board of Overseers**Chairman**

Lynda Schubert Bodman
Schubert Associates

Albert Aiello, Jr.

Sam Albert
Sam Albert Associates

Richard Anders

Software Publications

David Anderson

Amdahl Corporation

Gary J. Beach

CIO Communications

C. Gordon Bell

Microsoft Corporation

Gwen Bell

Founding President
The Computer Museum

Edward Belove

Erich Bloch
Council on Competitiveness

Jeff Braun

Electronic Arts

Daniel Bricklin

Trellix Corporation

Richard A. Carpenter

Carpenter Associates

Vinton G. Cerf

MCI WorldCom

Howard E. Cox, Jr.

Greylock Management Corporation

Andrea Cunningham

Cunningham Communication

Robert E. Davoli

Sigma Partners

Charles Digate

Mathsoft

Judith Donath

MIT Media Lab

Lacy H. Edwards

Evoke Software

Robert R. Everett

Concept Five Technologies

William Foster

Team Foster

Peter S. Hirshberg

Peter Hirshberg and Associates

Terri Holbrooke

Ziff-Davis

Charles House

Spectron Microsystems

Max D. Hopper

Max D. Hopper and Associates

Yezdi Lashkari

Microsoft Corporation

James A. Lawrence

Northwest Airlines

Dr. Robert Lucky

Bellcore Corporation

George McClelland

United Asset Management

Patrick J. McGovern

International Data Group

James McKenney

Harvard Business School

David C. Mahoney

Carver A. Mead
California Institute of Technology

Christopher Morgan

Christopher Morgan Communications

Laura Barker Morse**Christopher H. Murray**

ABT Corporation

Isaac R. Nassi

InfoGear Technology Corporation

David Nelson

Savoy Software Development

Suhas S. Patil

Cirrus Logic

Nicholas A. Pettinella

Intermetrics

Bernard L. Peuto

Concord Consulting

Joyce L. Plotkin

Massachusetts Software Council

John William Poduska, Sr.

Advanced Visual Systems

Howard Salwen

F. Grant Saviers

Adaptec

Edward A. Schwartz, Esq.

New England Legal Foundation

Naomi O. Seligman

The Research Board

Paul Severino

NetCentric Corporation

Hal Shear

Research Investment Advisors, Ltd.

John Shoch

Asset Management Associates

Michael Simmons**Dr. W. J. Spencer**

Sematech

James Sutter

Juanita Wade

Boston City Hall

Honorary Trustees

Charles Bachman

David Chapman

Jon Eklund

Richard E. Greene

Theodore Johnson

Mitchell Kapur

Pat Collins Nelson

Russell Noftsker

Brian Randell

Jonathan Rotenberg

Jean E. Sammet

Irwin J. Sitkin

Michael Spock

Board Standing Committees**Executive Committee**

Lawrence Weber (chair)

Paul Egerman

J. Thomas Franklin, Esq.

David L. House

Barry Nearhos

Mitchel Resnick

Leonard J. Shustek

Gardner C. Hendrie

Finance, Investment and Audit

Barry Nearhos (chair)

Nicholas A. Pettinella

Lynda Schubert Bodman

James McKenney

Development Committee

Richard M. Burnes, Jr. (chair)

Paul Egerman

Lawrence Weber

Laura Barker Morse

Hal Shear

Charles Digate

Paul Severino

Robert E. Davoli

David C. Mahoney

Marketing and Public Relations Committee

Lawrence Weber

Christine G. Hughes

Sam Albert

Gary J. Beach

Terri Holbrooke

Exhibits and Education Committee

Mitchel Resnick (co-chair)

Lee S. Sproull (co-chair)

Edward Belove

Judith Donath

Oliver Strimpel

Nominating (Board Development) Committee

Lawrence Weber

Dorothy A. Terrell

Richard M. Burnes, Jr.

Gardner C. Hendrie

David L. House

Leonard J. Shustek

Joyce L. Plotkin

Samuel Fuller

General Counsel

Lucash, Gesmer, Updegrove, LLP